



Üksikasju vaadake kasutusjuhendist.

Kiirjuhend

DAV-TZ215/DAV-TZ715

1 Kõlarite ühendamine

DAV-TZ715 puhul on vaja kõlarid kokku panna. Vaadake kaasasolevat kõlarite paigaldusjuhendit.

Kõlarite juhtmete ühendamine kõlaritega

Ühendage juhtmed nii, et juhtme värviline toru vastab kõlari taga oleva sildi värvile.

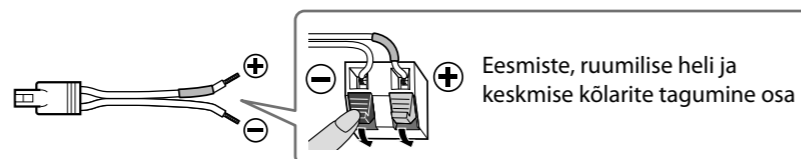

Ühendage kõlari juhtmed seadme pistikute SPEAKERS juhtmete värvide järgi.

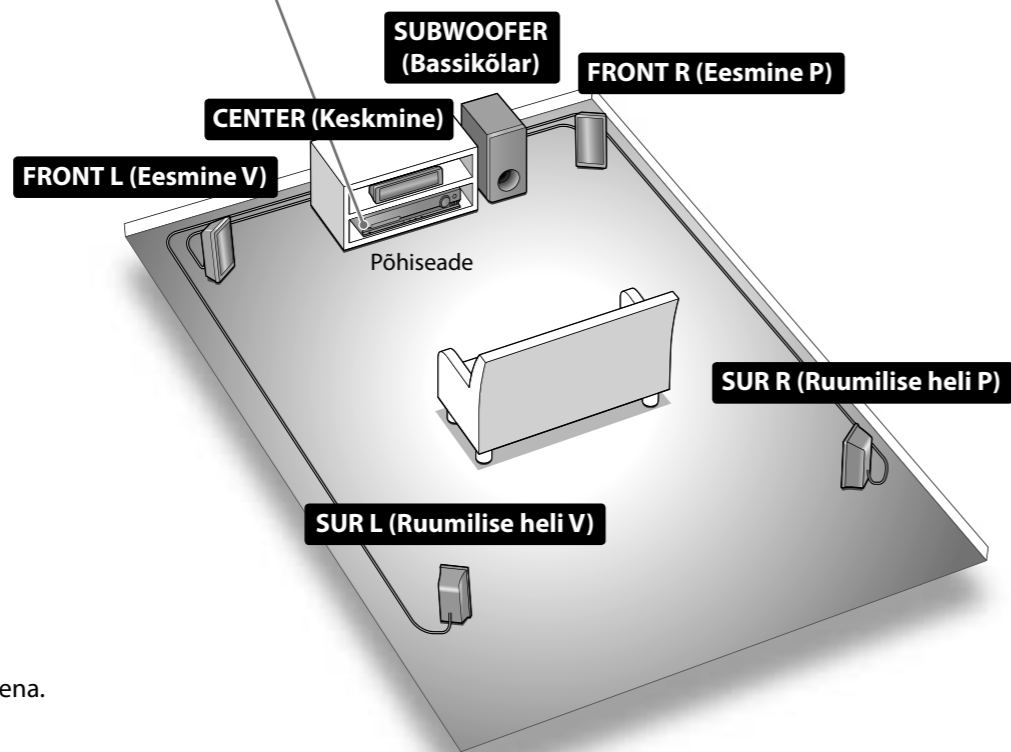
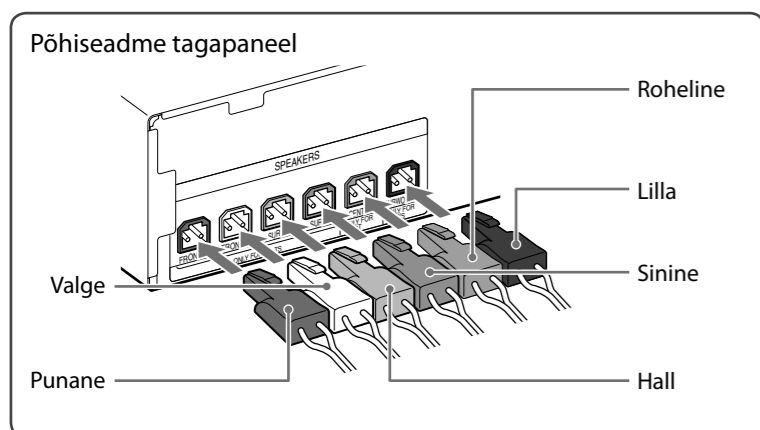

Mudelit DAV-TZ215 kasutatakse näitena.

2 Teleri/vastuvõtjaboksi ühendamine

Sõltuvalt teleri või vastuvõtjaboksi pistikutest valige video ja heli ühendamise meetod.

Video ühendamine teleriga

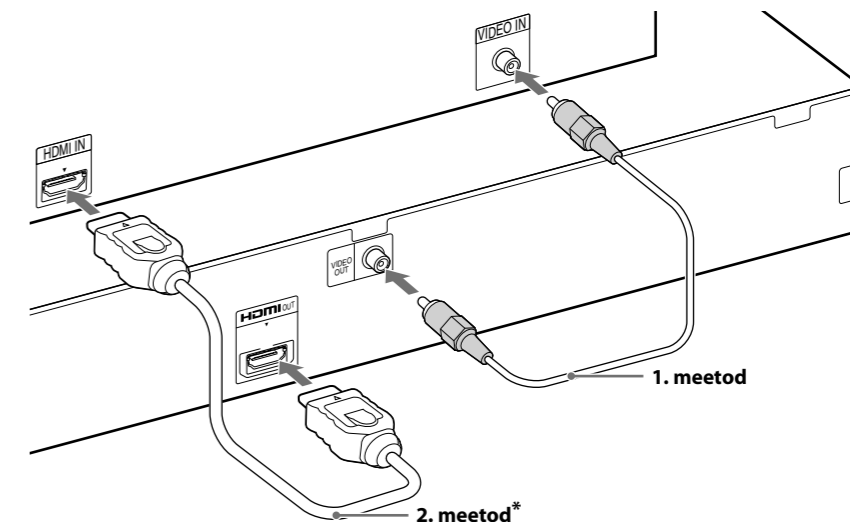
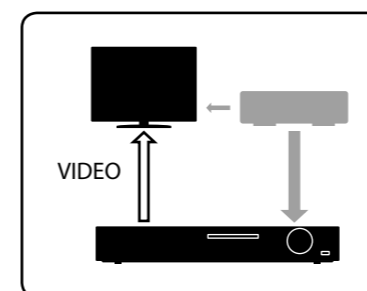

* Kiire HDMI-kaabel on kaasas ainult teatud mudelitega või teatud piirkondades.

Heli ühendamine vastuvõtjaboksist

Kui te ei kasuta vastuvõtjaboksi, lugege kasutusjuhendi jaotist Teleri/vastuvõtjaboksi ühendamine.

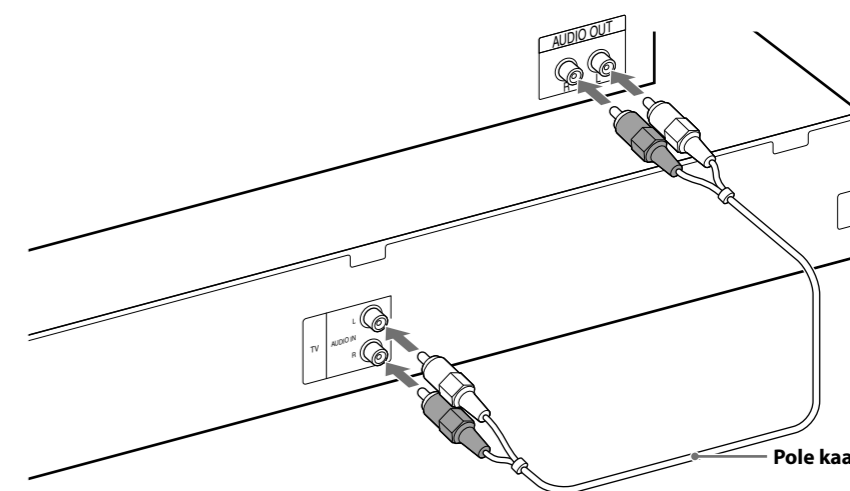
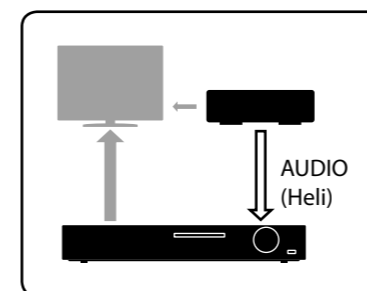

3 Kiirseadistamine

Märkus

Ärge sisestage plaati enne kiirseadistamist.

1 Ühendage vahelduvvoolu toitejuhe.

Seinakontakti kuju erineb piirkonniti.

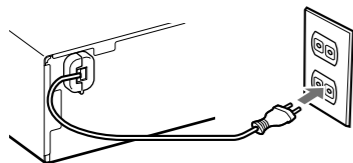

2 Lülitage sisse põhiseadme ja teleri toide.

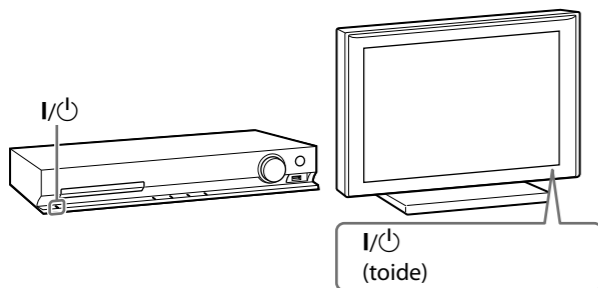

3 Valiku SONY Home Theatre System kuvamiseks vajutage teleril sisendi valijat.

4 Seadistage järgmised elemendid, kasutades nuppe ←/↑/↓/→ ja ⊕.

Kuvatud üksused erinevad sõltuvalt piirkonnast.

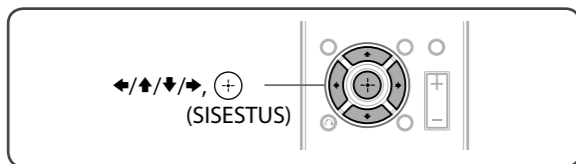

Teleri heli kuulamine kõigist kõlaritest

1 Vajutage nuppu TV.

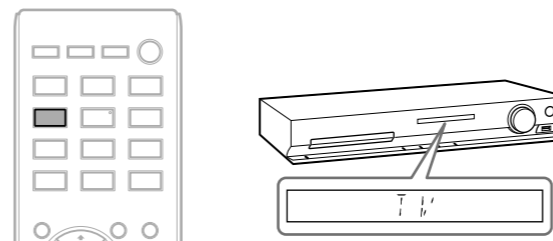

2 Vajutage nuppu SYSTEM MENU.

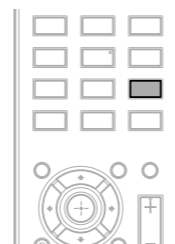

3 Vajutage nuppu ↑/↓ et kuvada tekst SUR.SETTING, seejärel vajutage nuppu ⊕.

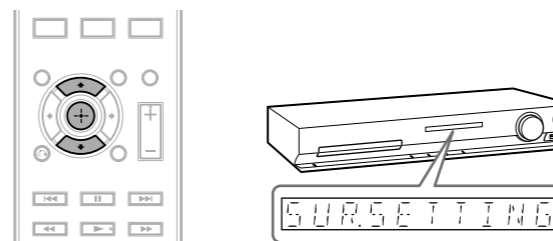

4 Vajutage nuppu ↑/↓, et kuvada tekst PRO LOGIC, seejärel vajutage nuppu ⊕.

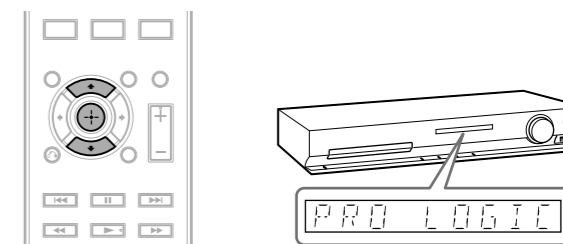

5 Menüüst väljumiseks vajutage nuppu SYSTEM MENU.

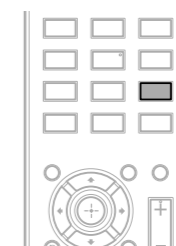

Valige ekraanil kuvatav keel.

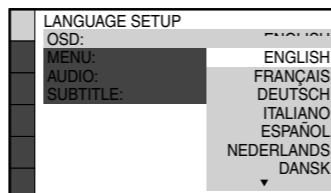
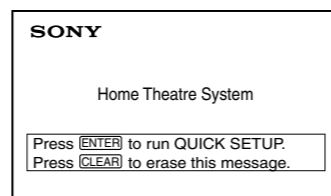

Valige ühendatud teleri kuvasuhe.

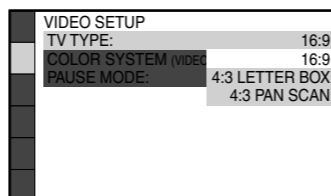

Kui ühendate põhiseadme ja teleri HDMI-kaabliga, valige olek [ON] (Sees).

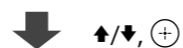
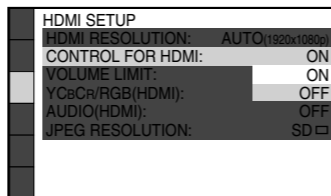

Valige kõlarite paigutus.

