

1

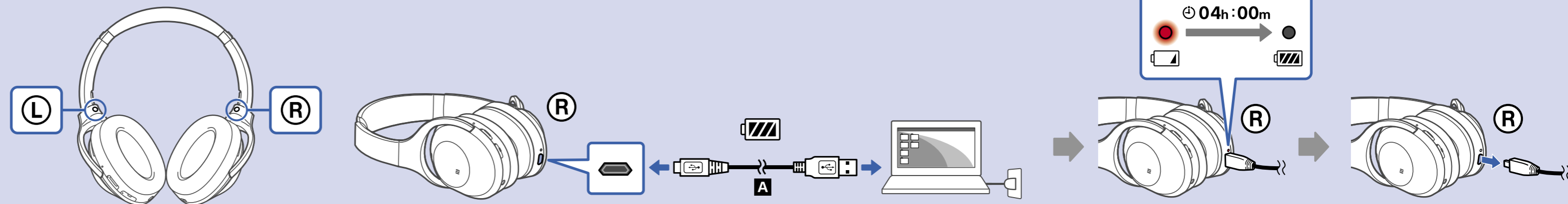

2

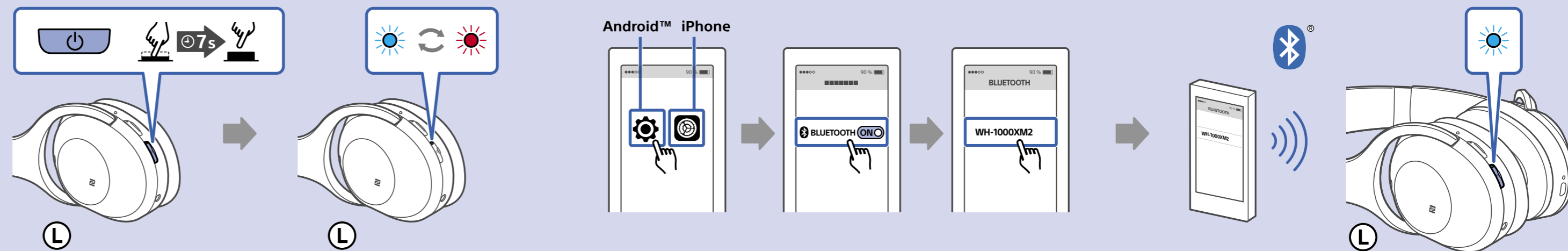

WH-1000XM2



3

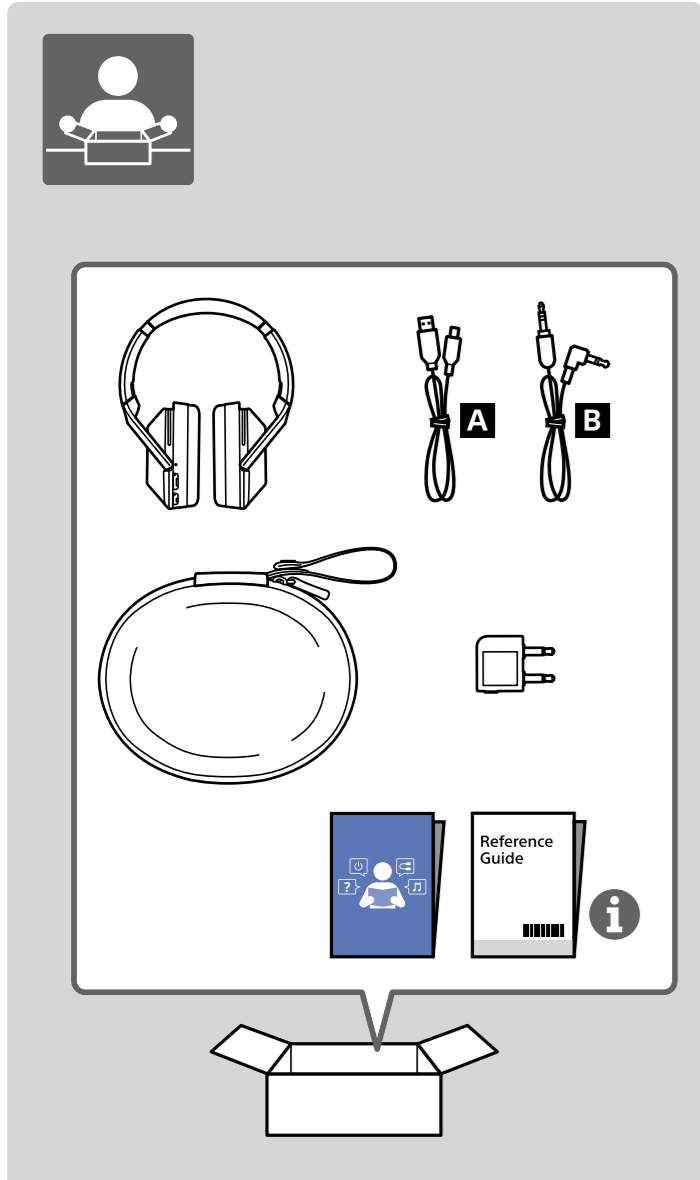
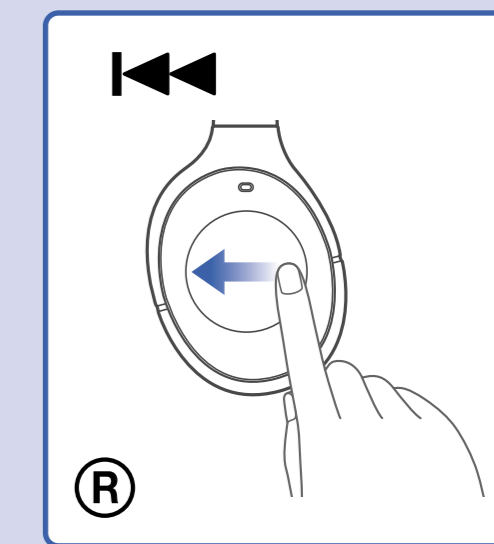
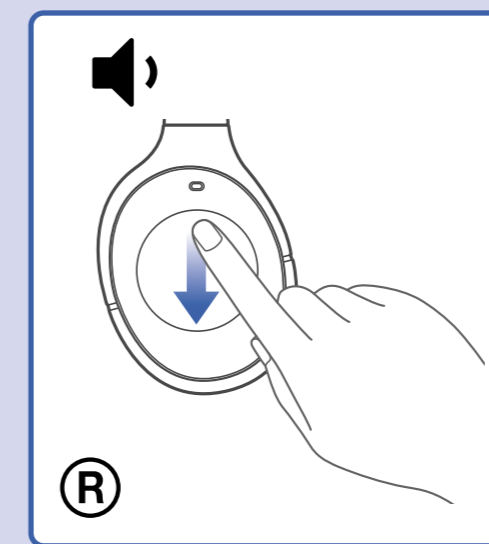
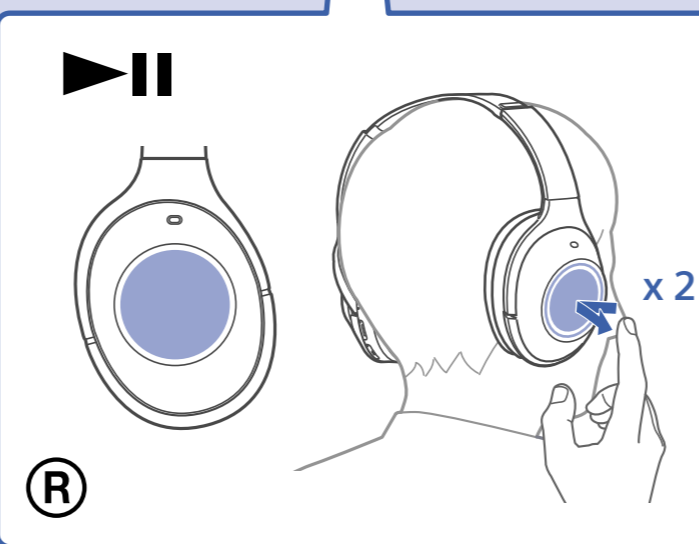
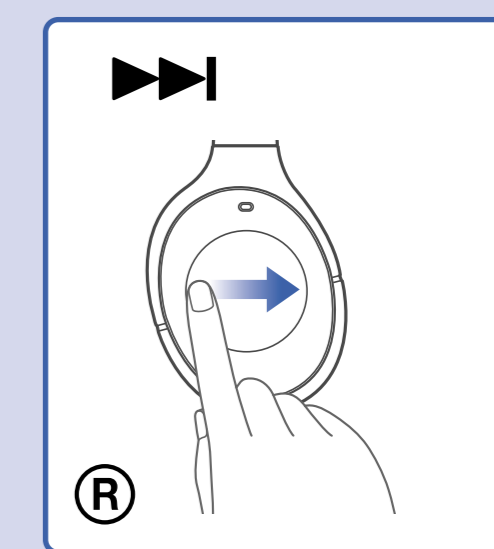
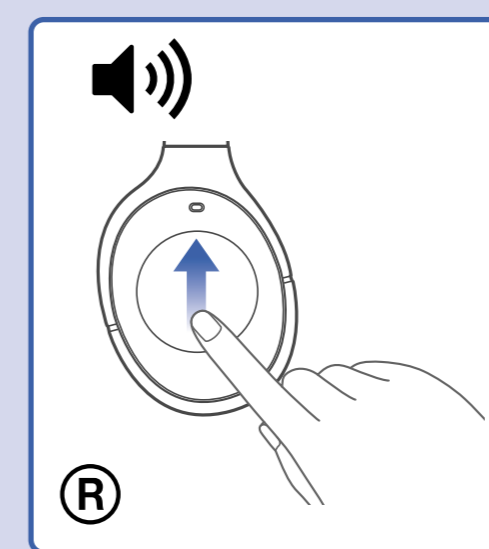
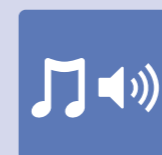
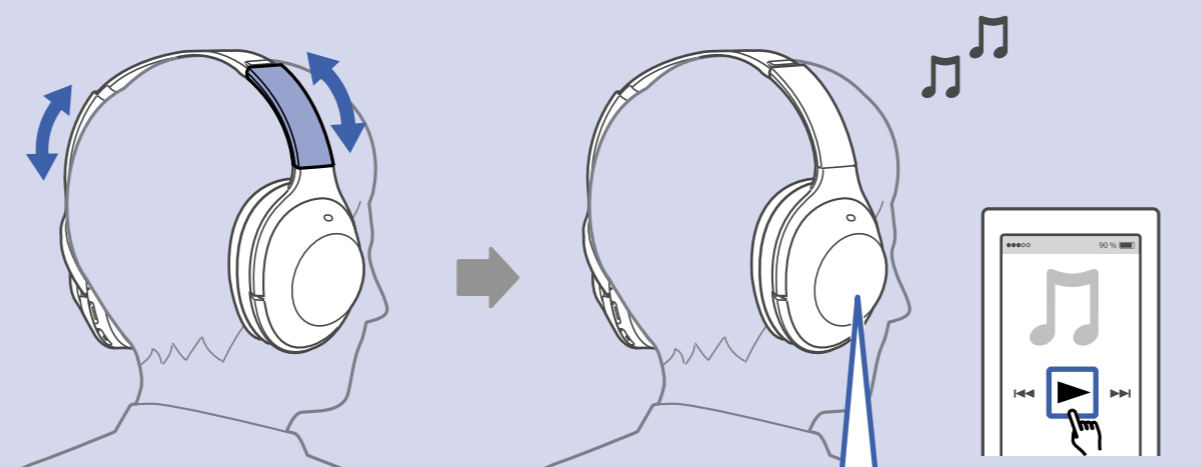

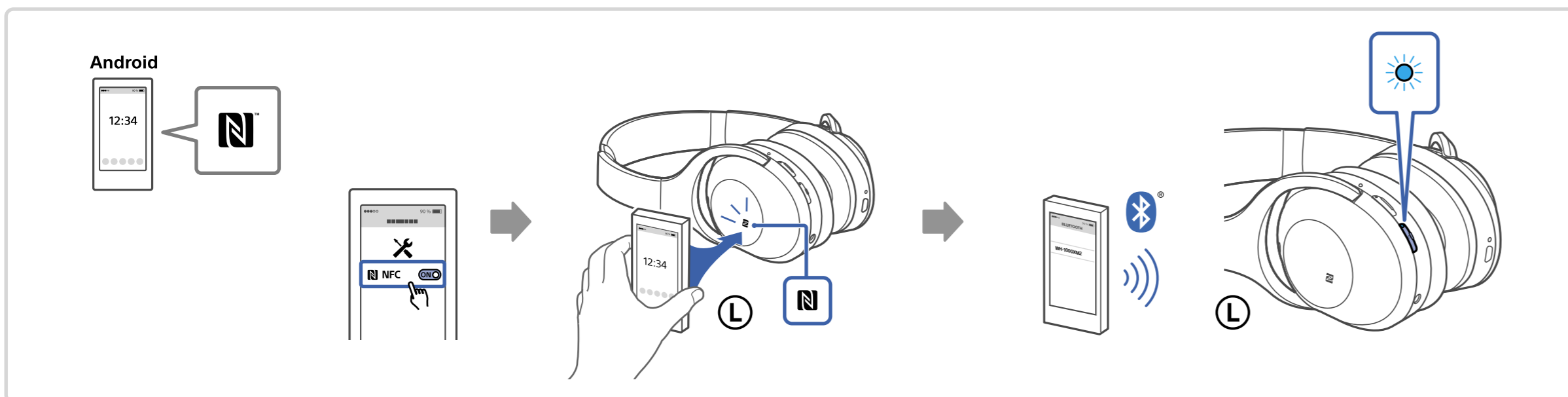
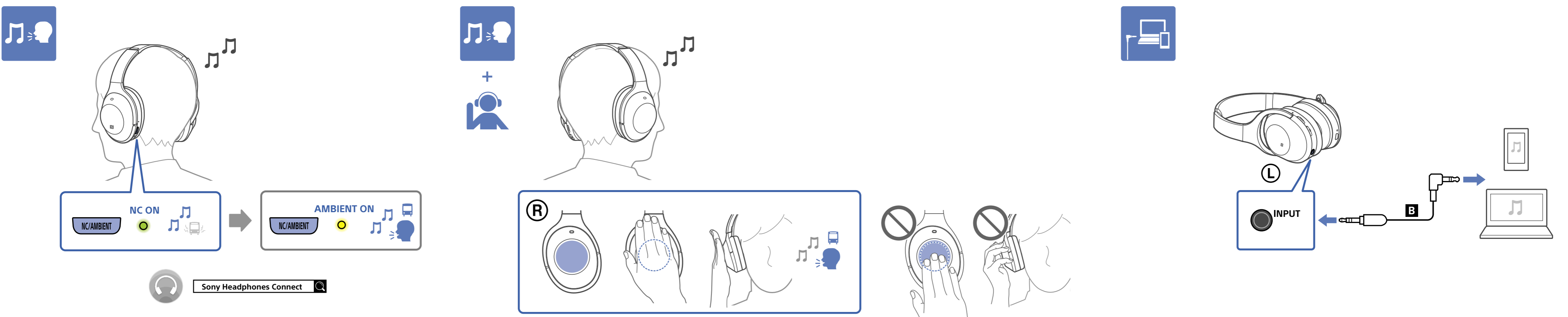
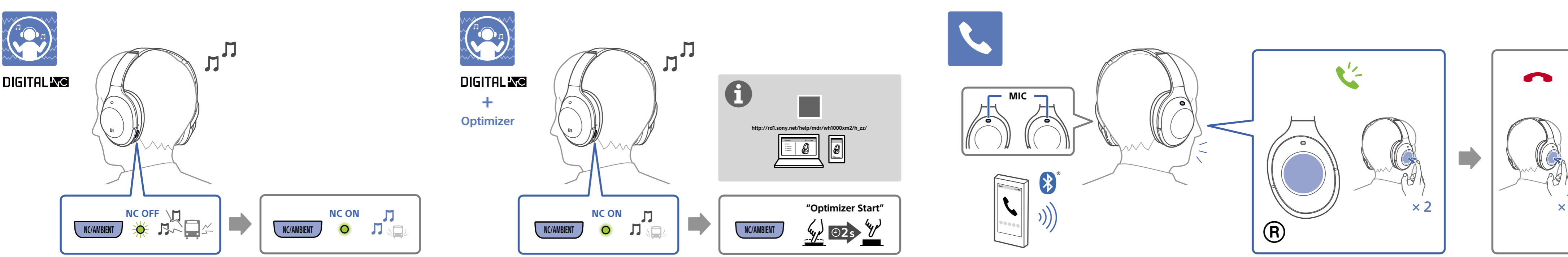
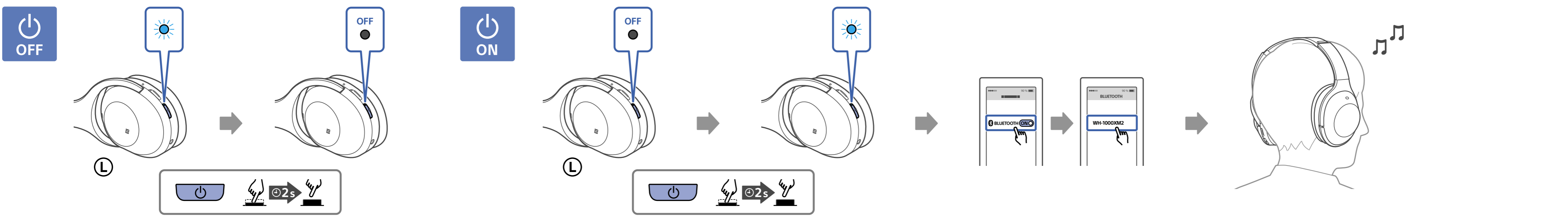

i

http://rd1.sony.net/help/mdr/wh1000xm2/h_zz/

This block contains a QR code and a link to the product support page. It also shows a laptop and a smartphone displaying the product information.