

SONY®

Sound Bar

Operating Instructions

WARNING

Do not install the appliance in a confined space, such as a bookcase or built-in cabinet.

To reduce the risk of fire, do not cover the ventilation opening of the appliance with newspapers, tablecloths, curtains, etc.

Do not expose the appliance to naked flame sources (for example, lighted candles).

To reduce the risk of fire or electric shock, do not expose this appliance to dripping or splashing, and do not place objects filled with liquids, such as vases, on the appliance.

The unit is not disconnected from the mains as long as it is connected to the AC outlet, even if the unit itself has been turned off.

As the main plug is used to disconnect the unit from the mains, connect the unit to an easily accessible AC outlet. Should you notice an abnormality in the unit, disconnect the main plug from the AC outlet immediately.

As the main plug of AC power adapter is used to disconnect the AC power adapter from the mains, connect it to an easily accessible AC outlet. Should you notice an abnormality in it, disconnect it from the AC outlet immediately.

Do not expose batteries or appliances with battery-installed to excessive heat, such as sunshine and fire.

Indoor use only.

Recommended cables

Properly shielded and grounded cables and connectors must be used for

connection to host computers and/or peripherals.

For the Bar Speaker

The nameplate is located on the bottom of the Bar Speaker.

For the AC adapter

Labels for AC adapter Model No. and Serial No. are located at the bottom of AC adapter.

For the customers in Europe

Notice for customers: the following information is only applicable to equipment sold in countries applying EU directives.

This product has been manufactured by or on behalf of Sony Corporation, 1-7-1 Konan Minato-ku Tokyo, 108-0075 Japan. Inquiries related to product compliance based on European Union legislation shall be addressed to the authorized representative, Sony Belgium, bijkantoor van Sony Europe Limited, Da Vincilaan 7-D1, 1935 Zaventem, Belgium. For any service or guarantee matters, please refer to the addresses provided in the separate service or guarantee documents.



Hereby, Sony Corp., declares that this equipment is in compliance with the essential requirements and other relevant provisions of Directive 1999/5/EC.

For details, please access the following URL:

<http://www.compliance.sony.de/>

This product is intended to be used in the following countries.

AT, BE, BG, HR, CY, CZ, DK, EE, FI, FR, DE, GR, HU, IS, IE, IT, LV, LI, LT, LU, MT, NL,

NO, PL, PT, RO, SK, SI, ES, SE, CH, GB, AL, BA, MK, MD, RS, ME, TR, Kosovo

5150-5350 MHz band is restricted to indoor operations only.

This equipment has been tested and found to comply with the limits set out in the EMC regulation using a connection cable shorter than 3 meters.



Disposal of Old Electrical & Electronic Equipment (Applicable in the European Union and other countries with separate collection systems)

This symbol on the product or on its packaging indicates that this product shall not be treated as household waste. Instead it shall be handed over to the applicable collection point for the recycling of electrical and electronic equipment. By ensuring this product is disposed of correctly, you will help prevent potential negative consequences for the environment and human health, which could otherwise be caused by inappropriate waste handling of this product. The recycling of materials will help to conserve natural resources. For more detailed information about recycling of this product, please contact your local Civic Office, your household waste disposal service or the shop where you purchased the product.



Disposal of waste batteries (applicable in the European Union and other European countries with

separate collection systems)

This symbol on the battery or on the packaging indicates that the battery provided with this product shall not be treated as household waste.

On certain batteries this symbol might be used in combination with a chemical symbol. The chemical symbols for mercury (Hg) or lead (Pb) are added if the battery contains more than 0.0005% mercury or 0.004% lead.

By ensuring these batteries are disposed of correctly, you will help prevent potentially negative consequences for the environment and human health which could otherwise be caused by inappropriate waste handling of the battery. The recycling of the materials will help to conserve natural resources.

In case of products that for safety, performance or data integrity reasons require a permanent connection with an incorporated battery, this battery should be replaced by qualified service staff only.

To ensure that the battery will be treated properly, hand over the product at end-of-life to the applicable collection point for the recycling of electrical and electronic equipment. For all other batteries, please view the section on how to remove the battery from the product safely. Hand the battery over to the applicable collection point for the recycling of waste batteries.

For more detailed information about recycling of this product or battery, please contact your local Civic Office, your household waste disposal service or the shop where you purchased the product.

Table of Contents

| | |
|---------------------------------------|----|
| What's in the Box | 6 |
| What You Can Do with the System | 8 |
| Guide to Parts and Controls | 10 |
| About the Home Menu | 15 |

Setup

| | |
|---|-------------------------------------|
| Basic Setup | ➔ Startup Guide (separate document) |
| Connecting a TV or Portable Audio Device via the ANALOG IN Jack | 17 |
| Connecting to a Wired Network | 18 |
| Connecting to a Wireless Network | 19 |
| Detaching the Grille Frame | 21 |

Listening to the Sound

| | |
|--|----|
| Listening to the TV | 22 |
| Listening to the Connected AV Device | 22 |
| Listening to Music on a USB Device | 23 |

Selecting the Sound Effect

| | |
|--|----|
| Setting the Sound Effect that is Tailored to Sound Sources (SOUND FIELD) | 24 |
| Enjoying Clear Sound with Low Volume at Midnight (NIGHT) | 25 |
| Making Dialogues Clearer (VOICE) | 25 |
| Adjusting the Volume of the Subwoofer | 26 |
| Adjusting the Delay Between the Picture and Sound | 26 |

Listening to Music/Sound with the BLUETOOTH Function

| | |
|--|----|
| Listening to Music from a Mobile Device | 27 |
| Listening to Sound of the Connected TV or Device from Headphones | 30 |

Listening to Music/Sound Using the Network Function

| | |
|---|----|
| Listening to Music on your PC via a Home Network | 32 |
| Listening to Music on the Mobile Device with SongPal | 33 |
| Using Chromecast built-in | 34 |
| Using Spotify | 35 |
| Using the MUSIC SERVICE Button | 36 |
| Connecting the SongPal Link-Compatible Device (Wireless Multi Room/Wireless Surround) | 37 |

Using the Various Functions/Settings

| | |
|---|----|
| Customizing the Speaker Settings for Surround Sound | 39 |
| Performing the Wireless Connection of the Subwoofer (SECURE LINK) | 40 |
| Playing Compressed Audio Files by Upscaling to Near Hi-Resolution Sound Quality (DSEE HX) | 42 |
| Enjoying Multiplex Broadcast Sound (AUDIO) | 42 |
| Deactivating Buttons on the Main Unit | 43 |
| Changing the Brightness of the Front Panel Display and BLUETOOTH Indicator (DIMMER) | 43 |

| | |
|--|----|
| Saving Power in Standby Mode | 44 |
| Sending the Remote Signal to the TV via the Main Unit | 44 |
| Using the Control for HDMI Function | 45 |
| Using the "BRAVIA" Sync Function | 46 |
| Using the Setup Display | 48 |
| Options Menu List | 54 |
| Troubleshooting | |
| Troubleshooting | 55 |
| Resetting the System | 62 |
| Additional Information | |
| Specifications | 63 |
| Power Consumption by the Setting Value for Each Standby Mode | 65 |
| Playable Types of Files | 66 |
| Supported Input Audio Formats | 67 |
| On BLUETOOTH Communication | 68 |
| END USER LICENSE AGREEMENT | 69 |
| Precautions | 73 |
| Index | 77 |

What's in the Box

- Bar Speaker (1)

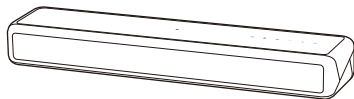

- Subwoofer (1)

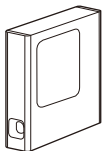

- Remote control (1)

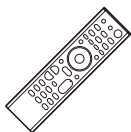

- R03 (size AAA) battery (2)



- Optical digital cable (1)

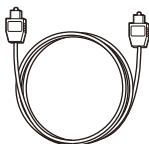

- AC adapter (1)

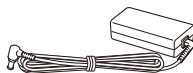

- AC power cord (mains lead) (1)



- AC power cord (mains lead) for the subwoofer (1)



- Speaker pad for the subwoofer (4)



- Startup Guide



- Operating Instructions



What You Can Do with the System

"Listening to the TV" (page 22)

"Listening to the Connected AV Device" (page 22)



Blu-ray Disc™ player, cable box, or satellite box, etc.



Connecting the TV
(refer to "Startup Guide" (separate document) or see "Connecting a TV or Portable Audio Device via the ANALOG IN Jack" (page 17).)

"Using the Control for HDMI Function"
(page 45)

"Using the "BRAVIA" Sync Function"
(page 46)

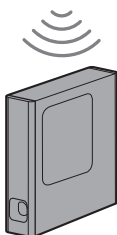
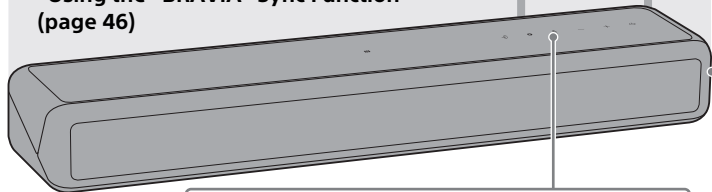

"Performing the Wireless Connection of the Subwoofer (SECURE LINK)" (page 40)



"Using Spotify" (page 35)*

"Using the MUSIC SERVICE Button" (page 36)

- * This service may not be available in some countries/regions.
- * To play on the system, you need the Spotify Premium account.



"Listening to Music on a USB Device" (page 23)

"Connecting to a Wired Network" (page 18)

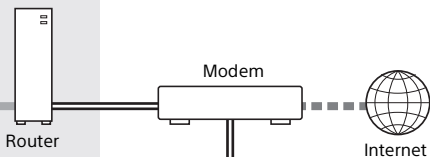

"Connecting to a Wireless Network" (page 19)

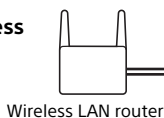

"Listening to Music on your PC via a Home Network" (page 32)

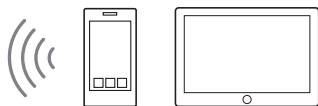

"Listening to Music from a Mobile Device" (page 27)

"Listening to Music on the Mobile Device with SongPal" (page 33)



"Listening to Sound of the Connected TV or Device from Headphones" (page 30)

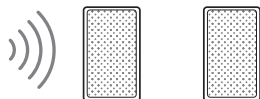

"Adding Rear Speakers (Wireless Surround)" (page 37)



"Listening to the Same Music in Different Rooms (Wireless Multi Room)" (page 37)

Guide to Parts and Controls

Details are omitted from the illustrations.

Bar Speaker (Main Unit)

Front

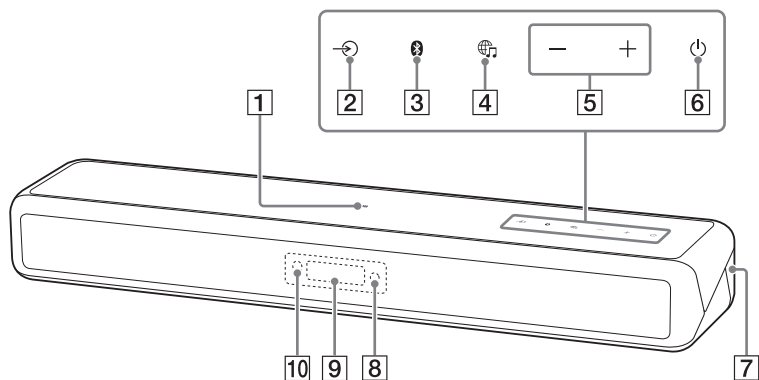

1 N-Mark (page 28)

When using the NFC function, touch your NFC-compatible device to the mark.

2 ↻ (input select) button (page 15, 22)

3 BLUETOOTH PAIRING button (page 27)

4 🎵 (MUSIC SERVICE) button (page 36)

5 +/- (volume) buttons

6 ⏻ (power) button

Turns on the system or sets it to standby mode.

7 📶 (USB) port (page 23)

8 BLUETOOTH indicator

- Flashes quickly in blue: During pairing standby status
- Flashes in blue: BLUETOOTH connection is being attempted
- Lights in blue: BLUETOOTH connection has been established

9 Front panel display

10 Remote control sensor

Point the remote control at the remote control sensor to operate the system.

Rear

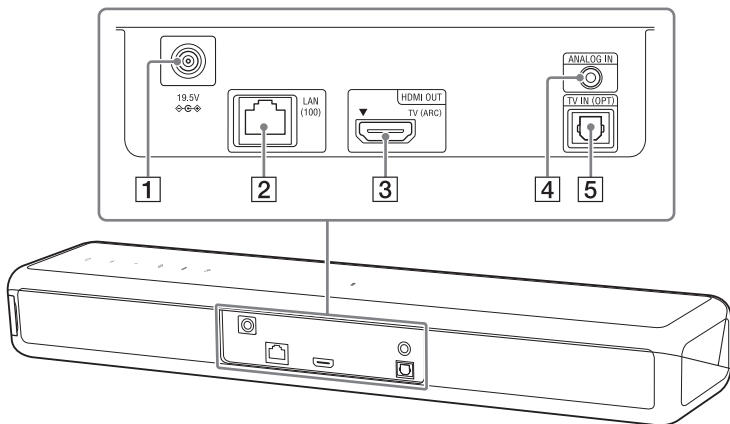

- 1** DC IN jack
- 2** LAN(100) port
- 3** HDMI OUT (TV (ARC)) jack
- 4** ANALOG IN jack
- 5** TV IN (OPT) jack

Subwoofer

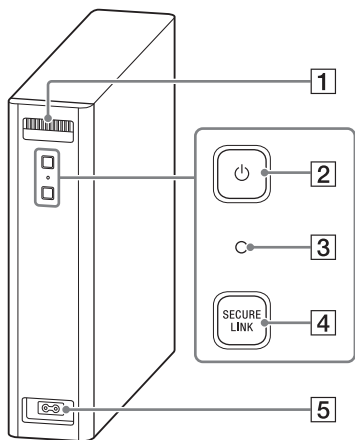

1 Ventilation holes

For safety, do not block the ventilation holes.

2 (power) button

Turns on the subwoofer or sets it to standby mode.

3 Power indicator

- Lights in red: The subwoofer is in standby mode
- Lights in green: The subwoofer is connected to the system
- Lights in orange: The subwoofer is connected to the system with the Secure Link function
- Flashes in green: The subwoofer is attempting to connect to the system
- Flashes in orange: The subwoofer is attempting to connect to the system with the Secure Link function

4 SECURE LINK button (page 40)

5 AC IN terminal

Remote Control

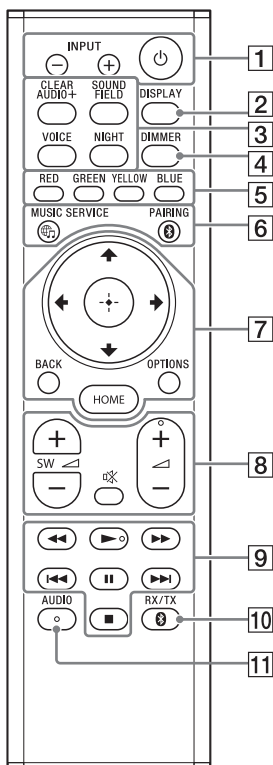

1 INPUT +/- (page 15, 22)

(power)

Turns on the system or sets it to standby mode.

2 DISPLAY

Displays playback information on the TV screen.

Playback information is not displayed for TV input.

3 CLEAR AUDIO+ (page 24)

SOUND FIELD (page 24)

VOICE (page 25)

NIGHT (page 25)

4 DIMMER (page 43)

5 Color buttons

Shortcut keys for selecting items on some menus.

6 MUSIC SERVICE (page 36)

BLUETOOTH PAIRING (page 27)

7 OPTIONS (page 26, 54)

BACK (page 15)

(page 15)

(enter) (page 15)

HOME (page 15)

8 (muting)

Turns off the sound temporarily.

(volume) +/-

Adjusts the volume.

SW (subwoofer volume) +/-

Adjusts the volume of the subwoofer.

9 Playback operation buttons

(rewind/fast forward)

Searches backward or forward.

(previous/next)

Selects the previous/next chapter, track, or file.

(play)*

Starts or re-starts playback (resume play).

(pause)



Pauses or re-starts playback.

(stop)

Stops playback.

10 BLUETOOTH RX/TX (BLUETOOTH receiver/transmitter) (page 31)

11 AUDIO* (page 42)

* The AUDIO, , and  + buttons have a tactile dot. Use it as a guide during operation.

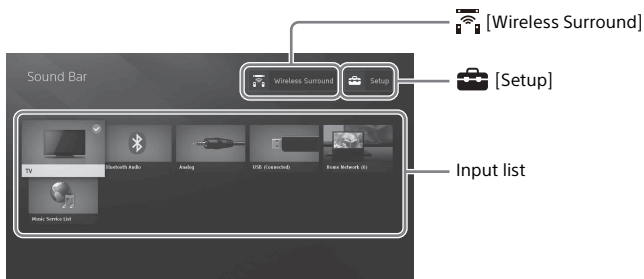

About the Home Menu

You can display the home menu on the TV screen by connecting the system and TV with the HDMI cable (not supplied). From the home menu, you can set the various settings by selecting  [Setup] or select the input or service that you want to watch from the input list. The home menu is displayed in the language that is selected in [Easy Setup]. (The following screen is an example when selecting English.)

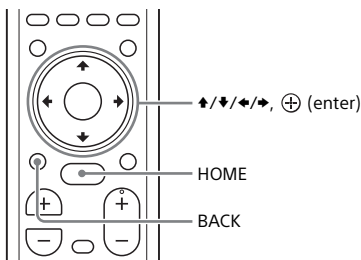

Using the Home Menu



- 1 Press HOME.**
The home menu appears on the TV screen.
- 2 Press $\uparrow/\downarrow/\leftarrow/\rightarrow$ to select  [Setup], an item on the input list, or  [Wireless Surround], then press \oplus .**
The selected input, setup display, or setting display for the wireless surround function appears on the TV screen.
To return to the previous screen, press BACK.

Input list

| Input name | Explanation |
|----------------------|--|
| [TV] | Outputs the TV sound. (page 22) |
| [Bluetooth Audio] | Outputs the sound of device that is connected with the BLUETOOTH function. (page 27) |
| [Analog] | Outputs the sound of device that is connected to the ANALOG IN jack. (page 22) |
| [USB] | Outputs music files stored on a connected USB device. (page 23) |
| [Home Network] | Outputs music files on the device that is connected via the network. (page 32) |
| [Music Service List] | Displays the operation method for music services. (page 36) |



[Setup]

See "Using the Setup Display" (page 48).



[Wireless Surround]

Displays the setting display for the wireless surround function that allows you to use the wireless speakers (not supplied) as the surround speakers of the system. Perform the setting by following the on-screen instructions. For details about the supported wireless speakers, refer to the following URL. <http://sony.net/nasite>

Tip

You can also select the input by pressing INPUT +/- repeatedly.

About the Steps Description

In these Operating Instructions, the operations are described as steps that are operated on the home menu displayed on the TV screen by using the remote control while the system and TV are connected with the HDMI cable (not supplied).

The operating steps that select items on the TV screen by using /// and are simplified in the following way.

Example: Select [Setup] from the home menu.

The operation that selects an item by pressing /// and is expressed as "select."

Example: Select [Network Settings] - [Internet Settings] - [Wired Setup] on the home menu.

When repeating the operation that selects an item by pressing /// and , the selected items are linked with "-."

Tips

- You can use the buttons on the main unit if they have the same or similar names as those on the remote control.
- Characters in brackets [] appear on the TV screen. Characters in quotes " " appear in the front panel display.

Basic Setup

Refer to Startup Guide (separate document).

Connecting a TV or Portable Audio Device via the ANALOG IN Jack

To connect following devices to the system, connect them via the ANALOG IN jack on the system.

- TV that does not have an HDMI jack and optical digital output jack
- Portable audio device such as a smartphone, WALKMAN®

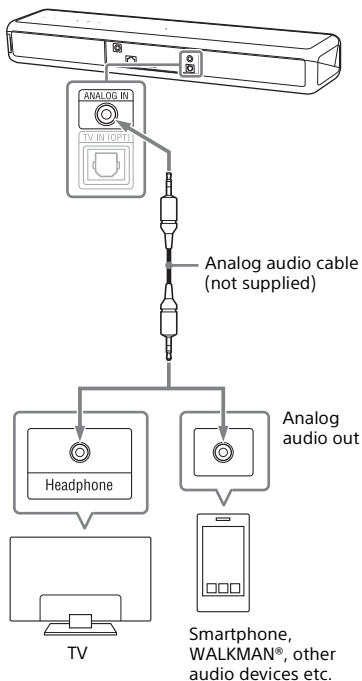

Note

If the TV's headphone jack also serves as an audio output jack, check the audio output settings of the TV. For details, refer to the operating instructions of the TV.

Connecting to a Wired Network

Prepare the network by connecting the system and PC to your home network with a LAN cable.

Connecting to a PC or Router with a LAN Cable

The following illustration is the example for connection of the system and PC to your home network.

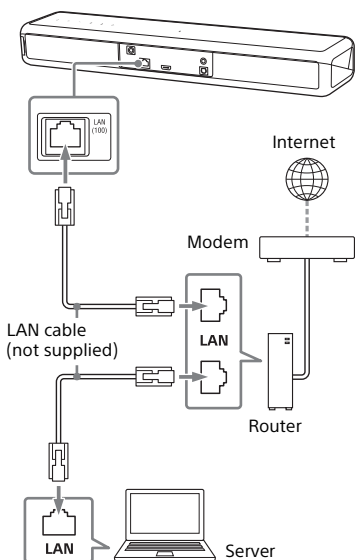





Note

The server needs to be connected to the same network as that of the system.

Tip

We recommend that you use a shielded straight interface cable (not supplied).

Connecting by Obtaining the Network Information Automatically



- 1 Press HOME.**
The home menu appears on the TV screen.
- 2 Select  [Setup] from the home menu.**
The setup display appears on the TV screen.
- 3 Select [Network Settings] - [Internet Settings] - [Wired Setup].**
- 4 Select [Auto].**
The system starts network settings and the network setting status appears.
Press / to browse information, and then press .
- 5 Select [Save & Connect].**
The system starts connecting to the network. For details, refer to the messages that appear on the TV screen.

Connecting by Using a Fixed IP Address

- 1 Press HOME.**
The home menu appears on the TV screen.
- 2 Select  [Setup] from the home menu.**
The setup display appears on the TV screen.
- 3 Select [Network Settings] - [Internet Settings] - [Wired Setup].**
- 4 Select [Manual].**

5 Perform the setting by following the on-screen instructions.

The system starts network settings and the network setting status appears.

Press / to browse information, and then press .

6 Select [Save & Connect].

The system starts connecting to the network. For details, refer to the messages that appear on the TV screen.

Connecting to a Wireless Network

Prepare the network by connecting the system and PC to your wireless LAN router.

Note

The server needs to be connected to the same network as that of the system.

Connecting with the WPS Button

When your wireless LAN router (access point) is Wi-Fi Protected Setup (WPS)-compatible, you can easily set the network settings with the WPS button.

1 Press HOME.

The home menu appears on the TV screen.

2 Select [Setup] from the home menu.

The setup display appears on the TV screen.

3 Select [Network Settings] - [Internet Settings] - [Wireless Setup] - [Wi-Fi Protected Setup™ (WPS)].

4 Select [Start].

5 Press the WPS button on the access point.

The system starts connecting to the network.

Connecting by Selecting the Network Name (SSID)

If your wireless LAN router (access point) is not compatible with Wi-Fi Protected Setup (WPS), check the following information in advance.

– The network name (SSID)*

– The security key (password)**

* SSID (Service Set Identifier) is a name that identifies a particular access point.

**This information should be available from a label on your wireless LAN router/ access point, from the operating instructions, from the person who set up your wireless network, or from the information provided by your Internet service provider.

- 1 Press HOME.**
The home menu appears on the TV screen.
- 2 Select  [Setup] from the home menu.**
The setup display appears on the TV screen.
- 3 Select [Network Settings] - [Internet Settings] - [Wireless Setup].**
The list of the network name appears on the TV screen.
- 4 Select the desired network name (SSID).**
- 5 Enter the security key (or password) using the software keyboard, and then select [Enter].**
The system starts connecting to the network.

Connecting by Using a Fixed IP Address

Select [New connection registration] - [Manual registration] in step 4 of "Connecting by Selecting the Network Name (SSID)" and follow the on-screen instructions.

Connecting by Using a PIN Code

Select [New connection registration] in step 4 of "Connecting by Selecting the Network Name (SSID)" and select [(WPS) PIN Method].

Connecting by SongPal

SongPal can connect the system to the same wireless network as that of the mobile device. For details, follow the instruction of the app or refer to the following URL.
<http://info.songpal.sony.net/help/>

Detaching the Grille Frame

You can detach the grille frame. We recommend that you use the main unit without attaching the grille frame if you will be listening to High-Resolution Audio.

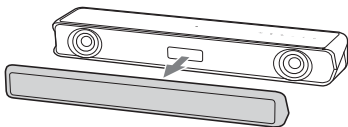

To attach the grille frame, fit it to the main unit by directing the arrow mark on the rear of the grille frame upward. The grille frame is fixed by a magnet.

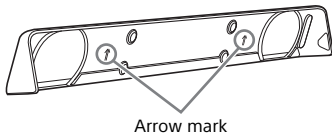

Listening to the TV

- 1 Press HOME.**

The home menu appears on the TV screen.
- 2 Select [TV] on the home menu.**
- 3 Select the program using the TV's remote control.**

The selected TV program appears on the TV screen and the TV sound is output from the system.
- 4 Adjust the volume.**
 - Adjust the volume by pressing \triangleleft +/- on the remote control.
 - Adjust the subwoofer volume by pressing SW \triangleleft +/- on the remote control (page 26).

Note

Set the speakers setting of the TV (BRAVIA) to Audio System. Refer to the operating instructions of your TV regarding how to set the TV.

Tip

You can select [TV] by pressing INPUT +/- on the remote control.

Listening to the Connected AV Device

- 1 Press HOME.**

The home menu appears on the TV screen.
- 2 Select [Analog].**

The [Analog] screen is displayed on the TV screen.
- 3 Adjust the volume.**
 - Adjust the volume by pressing \triangleleft +/- on the remote control.
 - Adjust the subwoofer volume by pressing SW \triangleleft +/- on the remote control (page 26).

Tip

You can select the input by pressing INPUT +/- on the remote control.

Listening to Music on a USB Device

You can play music files stored on a connected USB device.

For playable types of files, see “Playable Types of Files” (page 66).

- 1 Connect the USB device to the USB port.**

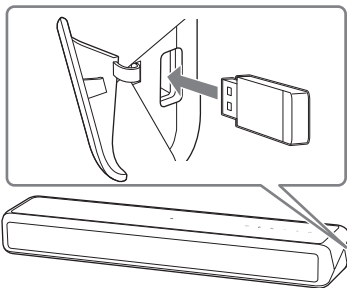

- 2 Press HOME.**
The home menu appears on the TV screen.

- 3 Select [USB (Connected)] from the home menu.**

- 4 Select the folder on which songs are stored - song.**

The selected song is played and sound is output from the system.

- 5 Adjust the volume.**

- Adjust the volume by pressing \triangleleft +/- on the remote control.
- Adjust the subwoofer volume by pressing SW \triangleleft +/- on the remote control (page 26).

Note

Do not remove the USB device during operation. To avoid data corruption or damage to the USB device, turn the system off before connecting or removing the USB device.

Tip

You can perform various operations from the options menu (page 54).

Selecting the Sound Effect

Setting the Sound Effect that is Tailored to Sound Sources (SOUND FIELD)

You can easily enjoy pre-programmed sound effects that are tailored to different kinds of sound sources.

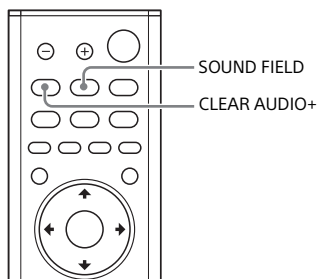

1 Press SOUND FIELD.

The sound field menu appears on the TV screen.

2 Press the button repeatedly to select the desired sound field.

| Sound field | Explanation |
|---------------|---|
| [ClearAudio+] | The appropriate sound setting is automatically selected for the sound source. |
| [Movie] | Sound effects are optimized for movies. This mode replicates the density and rich expanse of sound. |
| [Music] | Sound effects are optimized for music. |

| Sound field | Explanation |
|---------------|--|
| [Sports] | Commentary is clear, cheers are heard as surround sound, and sounds are realistic. |
| [Game Studio] | Sound effects are optimized for game play. |
| [Standard] | Sound effects are optimized for the individual source. |

Notes

- When using the wireless multi room function or Chromecast built-in, or setting [Bluetooth Mode] to [Transmitter] (page 50), the sound field function is not available.
- When using the wireless surround function, [Movie] or [Music] can be selected.
- The sound field menu does not appear on the TV screen for TV input.

Tips

- You can select [ClearAudio+] by pressing CLEAR AUDIO+ on the remote control.
- You can select the sound field from the options menu (page 54).

Enjoying Clear Sound with Low Volume at Midnight (NIGHT)

Sound is output at low volume with minimum loss of fidelity and clarity of dialogue.

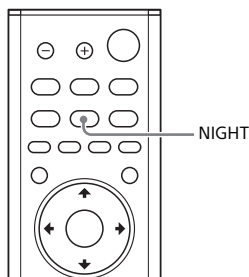

- 1 Press NIGHT.**
The night mode appears on the TV screen.
- 2 Press the button repeatedly to select the night mode.**

| Mode | Explanation |
|-------|--------------------------------------|
| [On] | Activates the night mode function. |
| [Off] | Deactivates the night mode function. |

Note

When you turn the system off, this setting is set to [Off] automatically.

Tip

You can select [Night] from the options menu (page 54).

Making Dialogues Clearer (VOICE)

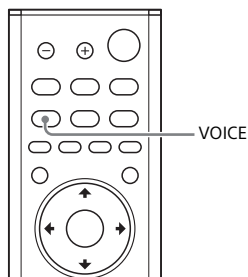

- 1 Press VOICE.**
The voice mode appears on the TV screen.
- 2 Press the button repeatedly to select the voice mode.**

| Mode | Explanation |
|----------|---|
| [Up Off] | Standard |
| [Up 1] | Dialogue is easily heard by enhancing dialogue range. |
| [Up 2] | Dialogue range is enhanced, and dialogue sound may be easy to hear for the elderly. |

Tip

You can select [Voice] from the options menu (page 54).

Adjusting the Volume of the Subwoofer

The subwoofer is designed for playback of bass or low frequency sound.

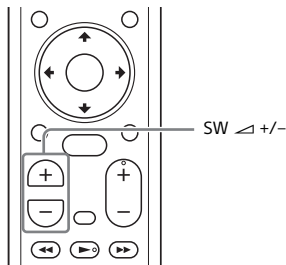

Press **SW (subwoofer volume) ▲ +/-** to adjust the volume of the subwoofer.

Note

When the input source does not contain much bass sound, such as in TV programs, the bass sound from the subwoofer may be difficult to hear.

Adjusting the Delay Between the Picture and Sound

When the sound does not match the pictures on the TV screen, you can adjust the delay between the picture and sound.

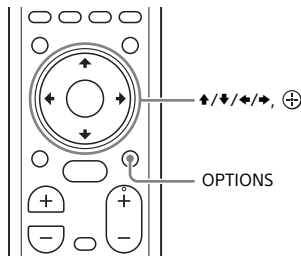

When Watching the TV

- 1 Press OPTIONS.**
"SYNC" appears in the front panel display.
- 2 Press → or ⊕**
The adjusting time appears in the front panel display.
- 3 Adjust the delay using ▲/▼, then press ⊕.**
You can adjust from 0 msec to 300 msec in 25 msec increments.
- 4 Press OPTIONS.**
The options menu in the front panel display turns off.

Listening to Music/Sound with the BLUETOOTH Function

Listening to Music from a Mobile Device

You can listen to music stored on a mobile device such as a smartphone or tablet via a wireless connection by connecting the system and the mobile device with the BLUETOOTH function. When connecting to the mobile device with the BLUETOOTH function, you can operate by simply using the supplied remote control without turning the TV on.

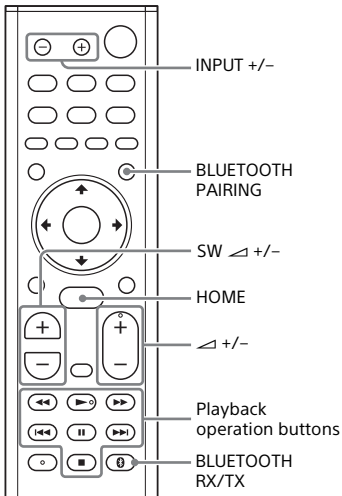

Listening to Music by Pairing with a Mobile Device

1 Press BLUETOOTH PAIRING.

The system enters the pairing mode, "BT" appears in the front panel display, and the BLUETOOTH indicator flashes quickly.

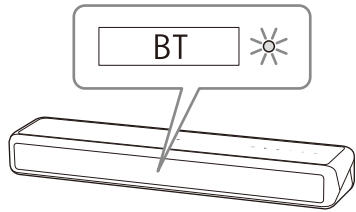

2 Turn on the BLUETOOTH function, and then select "HT-MT500/501" after searching for it on the mobile device.

If a Passkey is requested, enter "0000."

3 Make sure that the BLUETOOTH indicator on the main unit lights in blue.

A connection between the system and mobile device has been established.

4 Start audio playback with the music app on the connected mobile device.

Sound is output from the main unit.

5 Adjust the volume.

- Adjust the volume by pressing \triangle +/- on the remote control.
- Adjust the subwoofer volume by pressing SW \triangle +/- on the remote control (page 26).
- You can play or pause the content by using the playback operation buttons on the remote control.

To check the connection status of the BLUETOOTH function

| Status | BLUETOOTH indicator |
|--|-------------------------|
| During pairing status | Flashes quickly in blue |
| Connection is being attempted | Flashes in blue |
| Connection has been established | Lights in blue |
| Not connected | Off |

Tips

- Once the BLUETOOTH connection is established, an indication recommending which application to install will be displayed according to what device you have connected. Following the instructions displayed, an application called SongPal, which will enable you to operate this system, can be installed. See "Listening to Music on the Mobile Device with SongPal" (page 33) for details on SongPal.
- Perform pairing for the second and subsequent mobile devices.

Listening to Music from the Paired Mobile Device

1 Turn the BLUETOOTH function of the mobile device to on.

2 Press INPUT +/- repeatedly to display "BT" in the front panel display.

The system automatically reconnects to the mobile device it was most recently connected to.

3 Make sure that the BLUETOOTH indicator lights in blue.

A connection between the system and mobile device has been established.

4 Start audio playback with the music app on the connected mobile device.

Sound is output from the main unit.

5 Adjust the volume.

- Adjust the volume by pressing \triangleleft +/- on the remote control.
- Adjust the subwoofer volume by pressing SW \triangleleft +/- on the remote control (page 26).
- You can play or pause the content by using the playback operation buttons on the remote control.

To disconnect the mobile device

Perform any of the following items.

- Disable the BLUETOOTH function on the mobile device.
- Press BLUETOOTH PAIRING on the remote control.
- Turn off the system or mobile device.

Note

If "BT" does not appear in the front panel display by pressing INPUT +/- in step 2 of "Listening to Music from the Paired Mobile Device," press BLUETOOTH RX/TX on the remote control once.

Tip

When the connection is not established, select "HT-MT500/501" on the mobile device.

Connecting to a Mobile Device by One-Touch Function (NFC)

By holding an NFC-compatible mobile device such as a smartphone or tablet near the N mark on the main unit, the system is turned on automatically, then pairing and BLUETOOTH connection are performed automatically.

Compatible devices

Smartphones, tablets, and music players with the NFC function built-in (OS: Android™ 2.3.3 or later, excluding Android 3.x)

- 1 Turn on the NFC function of the mobile device.**
- 2 Touch the N mark on the main unit with the mobile device.**

Keep touching until the mobile device vibrates and message appears on the mobile device. Follow the on-screen instructions to complete pairing of the main unit and mobile device.

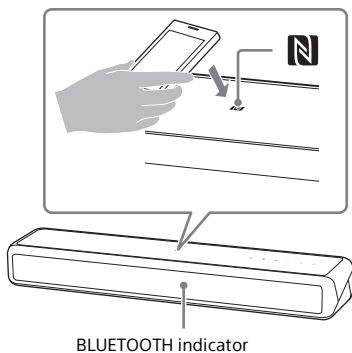

- 3 Make sure that the BLUETOOTH indicator lights in blue.**
A connection between the system and mobile device has been established.
- 4 Start audio playback with the music app on the connected mobile device.**
Sound is output from the system.

5 Adjust the volume.

- Adjust the volume by pressing \triangleleft +/- on the remote control.
- Adjust the subwoofer volume by pressing SW \triangleleft +/- on the remote control (page 26).
- You can play or pause the content by using the playback operation buttons on the remote control.

To stop playback by One-touch function

Touch the N mark on the main unit with the mobile device again.

Notes

- Depending on your device, you may need to perform the following items on your mobile device in advance.
 - Turn on the NFC function.
 - Install the "NFC Easy Connect" application from Google Play™ and start the application. (The application may not be available in some countries/regions.) For details, refer to the operating instructions of your device.
- This feature does not work with BLUETOOTH-compatible headphones. To listen to sound using a BLUETOOTH-compatible headphones, see "Listening to Sound of the Connected TV or Device from Headphones" (page 30).
- [Bluetooth Mode] is changed to [Receiver] automatically when making BLUETOOTH connection with the One-touch function. Even if the One-touch function is canceled, the [Bluetooth Mode] setting remains as [Receiver]. For details about [Bluetooth Mode], see [Bluetooth Settings] (page 50).
- If your mobile device is a type that goes into standby mode in response to magnetic force, it may not be able to be connected by NFC. When the One-touch function does not work, connect it by using the BLUETOOTH function (page 27).

Listening to Sound of the Connected TV or Device from Headphones

You can listen to sound of the connected TV or device from BLUETOOTH-compatible headphones by connecting it with the BLUETOOTH function.

Listening to Sound by Pairing with Headphones

1 Set the BLUETOOTH-compatible headphones to the pairing mode.

Refer to the operating instructions of the headphones for pairing method.

2 Press HOME.

The home menu appears on the TV screen.

3 Select [Setup] from the home menu.

The setup display appears on the TV screen.

4 Select [Bluetooth Settings] - [Bluetooth Mode] - [Transmitter].

The system enters BLUETOOTH transmission mode.

5 Select the name of the headphones from the [Device List] in [Bluetooth Settings].

When the BLUETOOTH connection is established, [Bluetooth device is connected.] appears. (The connected device name also appears.)

If you cannot find name of your headphones in [Device List], select [Scan].

6 Return to the home menu and select the desired input.

The image of the selected input appears on the TV screen, "BT TX" appears in the front panel display, then the sound is output from the headphones.

No sound is output from the system.

For selecting input, see "Using the Home Menu" (page 15).

7 Adjust the volume.

Adjust the volume level of the headphones first. The volume level of the headphones can be controlled with +/- on the main unit and  +/- on the remote control.

To remove a registered device from the device list

1 Follow steps 1 to 5 of "Listening to Sound by Pairing with Headphones."

2 Select the name of the headphones, and then press OPTIONS.

3 Select [Remove].

4 Follow the on-screen instructions to delete the desired headphones from the device list.

Listening to Sound with Paired Headphones

1 Press HOME.

The home menu appears on the TV screen.

2 Select the desired input.

For selecting input, see "Using the Home Menu" (page 15).

3 Set the BLUETOOTH function of the headphones to on.

4 Press BLUETOOTH RX/TX on the remote control.

[Bluetooth Mode] is set to [Transmitter] and "BT TX" appears in the front panel display.

The system automatically reconnects to the headphones it was most recently connected to, then the sound is output from the headphones.

No sound is output from the system.

5 Adjust the volume.

Adjust the volume level of the headphones. You can also adjust volume level of the headphones with \triangle +/- on the remote control.

To disconnect the headphones

Perform any of the following items.

- Disable the BLUETOOTH function on the headphones.
- Press BLUETOOTH RX/TX.
- Turn off the system or the headphones.
- Select the device name of the connected headphones from  [Setup] - [Bluetooth Settings] - [Device List].

About the Connection of the Headphones

- You may not be able to adjust the volume level depending on the BLUETOOTH-compatible headphones.
- [Bluetooth Audio] is disabled when [Bluetooth Mode] is set to [Off] or [Transmitter].
- When input of [Bluetooth Audio] is selected, you cannot set [Bluetooth Mode] to [Transmitter]. You cannot switch it with BLUETOOTH RX/TX on the remote control neither.
- You can register up to 9 BLUETOOTH devices. If a 10th BLUETOOTH device is registered, the oldest connected BLUETOOTH device will be overwritten by the new one.
- The system can display up to 15 detected BLUETOOTH device in the [Device List].
- You cannot change the sound effect or settings in the options menu while transmitting sound to the BLUETOOTH-compatible headphones.
- Some content may not be output due to content protection.
- Playback of audio/music on the BLUETOOTH device is delayed compared to that on the main unit due to the characteristics of BLUETOOTH wireless technology.
- You can enable or disable the reception of AAC or LDAC audio from the BLUETOOTH device (page 50).

Listening to Music/Sound Using the Network Function

Listening to Music on your PC via a Home Network

You can play music files stored on your PC via your home network.

Music files can be played by operating on the menu that is displayed on the TV screen or SongPal on a mobile device such as a smartphone or tablet.

Preparing the Home Network



- 1 Connect the system to a network.**
See "Connecting to a Wired Network" (page 18) and "Connecting to a Wireless Network" (page 19).
- 2 Connect the PC to a network.**
For details, refer to the operating instructions of the PC.
- 3 Set the PC.**
To use the PC on your home network, you need to set the PC as the server. For details, refer to the operating instructions of the PC.

Tip

See  [Setup] - [Network Settings] - [Network Connection Status] when checking the network connection status.

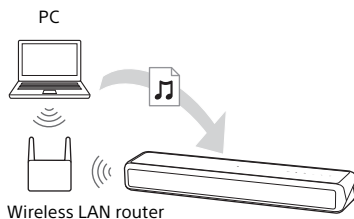
Listening to Music on a PC



- 1 Press HOME.**
The home menu appears on the TV screen.
- 2 Select [Home Network] from the home menu.**
The device name on your home network appears on the TV screen.
- 3 Select the desired device - folder on which songs are stored - song.**
The selected song is played and sound is output from the system.
- 4 Adjust the volume.**
 - Adjust the volume by pressing  +/- on the remote control.
 - Adjust the subwoofer volume by pressing SW  +/- on the remote control (page 26).

Tip

You can perform various operations from the options menu (page 54).

Listening to Music on a PC by Using SongPal

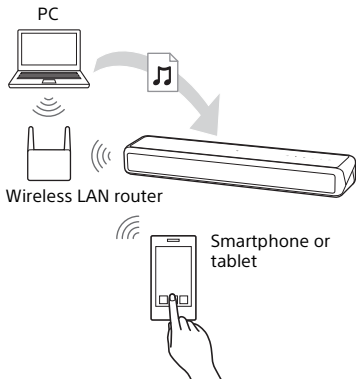

You can play music files stored on the PC by operating SongPal that is installed to a mobile device such as a smartphone or tablet. For details of SongPal, see “What You can Do with SongPal” (page 33) or the following URL. <http://info.songpal.sony.net/help/>

Listening to Music on the Mobile Device with SongPal

What You can Do with SongPal

SongPal is an application for controlling compatible Sony audio devices using the mobile device such as a smartphone or tablet.

For details about SongPal, refer to the following URL.
<http://info.songpal.sony.net/help/>

Installing SongPal onto your mobile device provides the following.

Sound settings of the system

You can easily customize your sound, or use the [ClearAudio+] setting recommended by Sony.

Music service

You can configure the initial settings to use music services*.

* Depending on the country and region, music services and their period of availability may differ.
An update of the device may be required.
When using Chromecast built-in on music service, see “Using Chromecast built-in” (page 34).

Enjoying music on your home network

You can play music stored in your PC or home network server over your network.

Enjoying music on the USB device

You can play music on a device connected to the  (USB) port on the main unit.

Note

What you can control with SongPal varies depending on the connected device. The specification and design of the application may change without notice.

Using SongPal

- 1 Install the free SongPal app to the mobile device.**
Search for SongPal at Google Play or the App Store and install it onto your mobile device.
- 2 Connect the system and mobile device with the BLUETOOTH function (page 27) or network function (page 18).**
- 3 Start SongPal.**
- 4 Operate by following the SongPal screen.**

Notes

- Before using SongPal, be sure to set the [Bluetooth Mode] to [Receiver] (page 50).
- Use SongPal of the latest version.

Tips

- You can connect the system and mobile device with the NFC function (page 28).
- When connecting with the network function, connect the mobile device to the same network as that of the system.

Using Chromecast built-in

Chromecast built-in allows you to select music content from the Chromecast-enabled app and play back on the system or group that the system is included.

- 1 Press HOME.**
The home menu appears on the TV screen.
- 2 Select [Music Service List] on the home menu.**
The music service list appears on the TV screen.
- 3 Select [Chromecast built-in].**
Perform the settings to use Chromecast built-in on the system by following the on-screen message.
- 4 Connect the mobile device by Wi-Fi to the same network as that of the system.**
- 5 Install the Chromecast-enabled app to the mobile device.**
- 6 Start the Chromecast-enabled app, tap the cast button, and select the system or group that the system is included.**



- 7 Select and play music on the Chromecast-enabled app.**
The music is played on the system.

Note

Depending on the country and region, Chromecast built-in and the Chromecast-enabled app may not be provided.

Using Spotify

You can select the music on the Spotify app and play it on the system. To play on the system, you need the Spotify Premium account.

Enabling the “Spotify Connect” Function

- 1** Connect the mobile device by Wi-Fi to the same network as that of the system.
- 2** Install the Spotify app to the mobile device.
- 3** Start the Spotify app and log in to the Spotify Premium account.
- 4** Select and start playing the music on the Spotify app.
- 5** Select the Connect icon on the Spotify app and select the system as the audio output device.

The music is played on the system.

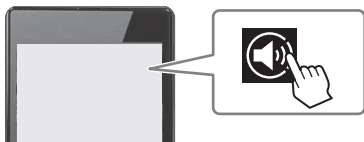

Resuming the Music that has Played on the Mobile Device

- 1** Press **MUSIC SERVICE**.
When you have played the music of Spotify on the system, the music that was played with Spotify is resumed. For details, see “Using the MUSIC SERVICE Button” (page 36).

Note

The Spotify app may not be available in some countries/regions.

Using the MUSIC SERVICE Button

To enjoy music services, the system must be connected to the Internet.

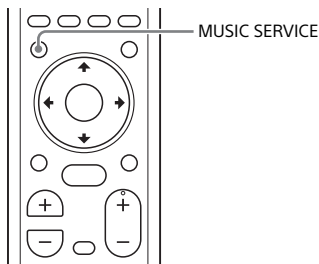
**Press MUSIC SERVICE.**

The music service list appears on the TV screen.

When you have played the music of Spotify on the system, the music that was played with Spotify is resumed. See "Using Spotify" (page 35) .

Notes

- Music services may not be available in some countries/regions.
- If the resume playback is not available, the last playlist played on the system plays.
- To play on the system, you need the Spotify Premium account.

Tips

- You can update the music service list by pressing OPTIONS and selecting [Update Services] on the music service list.
- You can display the music service list by selecting [Music Service List] on the home menu or pressing MUSIC SERVICE on the main unit.

Connecting the SongPal Link-Compatible Device (Wireless Multi Room/Wireless Surround)

You can enjoy music in any room or listen to music in surround sound by using the system with the SongPal Link-compatible wireless speaker.

Listening to the Same Music in Different Rooms (Wireless Multi Room)



Wireless Multi-room



You can enjoy the following music or sound in different rooms with high sound quality using your home wireless network.

- Music on the music service
- Music stored in your PC or smartphone
- Sound of the [TV] or [Analog] input of the system*

* You can enjoy the sound of the device that is connected to the system. The sound is delayed behind the picture for the above inputs. If you are bothered by a time gap between the sound and picture, cancel the wireless multi room function.

You can operate with SongPal that is installed on a mobile device. To use multiple SongPal-compatible devices, connect them to the same wireless LAN.

To perform setting on SongPal

Perform the setting by following the help on SongPal.

Note

This function is not available for music on the connected BLUETOOTH device to the system.

Tip

For details about SongPal, see "What You can Do with SongPal" (page 33).

Adding Rear Speakers (Wireless Surround)



Wireless Surround



You can add wireless speakers manufactured by Sony (not supplied) as the surround speakers of the system. Use the same model for the two wireless speakers. For details about applicable speakers, refer to the following URL.
<http://sony.net/nasite/>

Notes

- When using the wireless surround function, the wireless LAN function is not available. Connect to the network with a wired LAN.
- When using the wireless surround function, you cannot set [Bluetooth Mode] to [Transmitter] (page 50).
- When using the wireless surround function, [Bluetooth Codec - LDAC] (page 50) is not available.

To perform the setting on the system

1 Update the wireless speaker to the latest version.

The software of the wireless speaker is not updated automatically when using the wireless surround function. To update, cancel the wireless surround function and connect the wireless speaker to the internet.

2 Connect the system to the network with a wired LAN (page 18).

When using the wireless surround function, the wireless LAN function is not available.

3 Install the applicable speakers, and turn them on.

4 Press HOME.

The home menu appears on the TV screen.

5 Select [Setup] from the home menu.

The setup display appears on the TV screen.

6 Select [Wireless Surround Settings].

7 Perform the setting by following the on-screen instructions.

Tip

You can display the setting display for the wireless surround function by selecting  [Wireless Surround] on the home menu.

To perform the setting on SongPal

1 Update the wireless speaker to the latest version.

The software of the wireless speaker is not updated automatically when using the wireless surround function. To update, cancel the wireless surround function and connect the wireless speaker to the internet.

2 Connect the system to the network with a wired LAN (page 18).

When using the wireless surround function, the wireless LAN function is not available.

3 Install the applicable speakers, and turn them on.

4 Select the system on SongPal, then perform the setting by following the instructions on SongPal.

Note

The SongPal settings are effective with the SongPal of version 4.0 or later. For details about the SongPal installing, see "Using SongPal" (page 34).

To cancel the wireless surround function

Select  [Setup] - [Wireless Surround Settings] - [Stop Wireless Surround] on the home menu.

Customizing the Speaker Settings for Surround Sound

To obtain the best possible surround sound, set the speakers distance from your listening position and their output level, etc.
The default settings are underlined.

1 Press **HOME**.

The home menu appears on the TV screen.







2 Select **[Setup]** from the home menu.

The setup display appears on the TV screen.

3 Select **[Audio Settings]** - **[Speaker Settings]**.

The [Speaker Settings] screen appears on the TV screen.

4 Perform the speaker settings.

Select the setting item from the following items by pressing / and , then set the value in accordance with the environment by pressing / and .

[Distance]

Set the distance from the listening position to the speakers.

You can set the value from 0 meters to 10 meters (0.1 m step) (0 ft to 33 ft (1/4 ft step)).

[Front]¹⁾: Sets the front speaker distance.

[Subwoofer]¹⁾: Sets the subwoofer distance.

[Surround L]²⁾: Sets the left surround speaker distance.

[Surround R]²⁾: Sets the right surround speaker distance.

- 1) This item does not appear when using the wireless surround function.
- 2) This item appears when using the wireless surround function.

Tip

You can change measurement units (feet or meters) by pressing the color button (RED).

[Level]

Adjust the sound level of the speakers. For [Front] and [Subwoofer], you can set the value from -6.0 dB to 6.0 dB (0.5 dB step).

For [Surround L]* and [Surround R]*, you can set the value from -10.0 dB to 10.0 dB (0.5 dB step).

[Front]: Sets the front speaker level.

[Subwoofer]: Sets the subwoofer level.

[Surround L]*: Sets the left surround speaker level.

[Surround R]*: Sets the right surround speaker level.

* This item appears when using the wireless surround function.

[Test Tone]

The test tone is emitted from the speakers for checking the available speakers .

[Off]: The test tone is not emitted from the speakers.

[On]: The test tone emitted from each speaker in order.

[Sofa Mode]

Change this setting depending on the installation position of the subwoofer.

[On]: Select this when the subwoofer is installed under the sofa.

[Off]: Select this when the subwoofer is installed anywhere except under the sofa.

Performing the Wireless Connection of the Subwoofer (SECURE LINK)

You can specify the wireless connection to link the system to the subwoofer using the Secure Link function. This function can help prevent interference if you use multiple wireless products or your neighbors use wireless products.

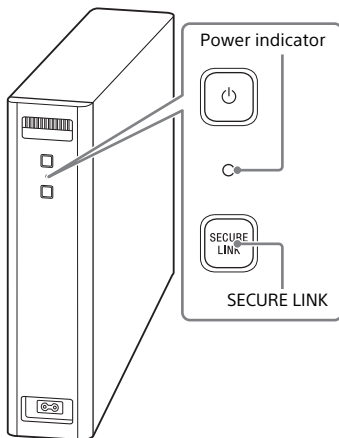

- 1 Press HOME.**
The home menu appears on the TV screen.
- 2 Select  [Setup] from the home menu.**
The setup display appears on the TV screen.
- 3 Select [System Settings] - [Wireless Subwoofer Connection] - [Secure Link].**
The [Secure Link] screen appears on the TV screen.

- 4 Select [On].**
- 5 Press SECURE LINK on the rear of the subwoofer.**
The power indicator of the subwoofer flashes in orange. Proceed to the next step within 1 minute.
- 6 Select [Start].**
The link setting starts. To return to the previous display, select [Cancel].
- 7 Complete the link setting by following the on-screen message.**
The power indicator of the subwoofer lights in orange.

Notes

- If the message [Cannot set Secure Link.] appears, follow the on-screen instructions.
- When [Bluetooth Mode] is set to [Transmitter] and the BLUETOOTH device is connected to the system, the wireless subwoofer connection cannot be established.

Selecting the Frequency Band

You can select the frequency band for better connection.

- 1 Press HOME.**
The home menu appears on the TV screen.
- 2 Select  [Setup] from the home menu.**
The setup display appears on the TV screen.
- 3 Select [System Settings] - [Wireless Subwoofer Connection] - [RF Band].**

4 Select the setting you want.

- [Auto] (default setting): Normally select this. The system automatically selects the strongest frequency band for transmission.
- [5.2GHz], [5.8GHz]: Transmits sound according to the selected frequency band.

Tip

We recommend you to set [RF Band] to [Auto].

If Wireless Transmission is Unstable

If you use multiple wireless systems, such as a wireless LAN, the wireless signals may be unstable. In this case, the transmission may be improved by changing the following [RF Channel] setting.

1 Press HOME.

The home menu appears on the TV screen.

2 Select [Setup] from the home menu.

The setup display appears on the TV screen.

3 Select [System Settings] - [Wireless Subwoofer Connection] - [RF Channel].

4 Select the setting you want.

- [Auto] (default setting): Normally select this. The system automatically selects the better channel for transmission.
- [1], [2], [3]: The system transmits sound by fixing the channel for transmitting. Select the channel with the better transmission.

Notes

- The transmission may be improved by changing the transmission channel (frequency) of the other wireless system(s). For details, refer to the operating instructions of the other wireless system(s).
- You cannot select this function when the [RF Band] is set to [Auto] (page 40).

Playing Compressed Audio Files by Upscaling to Near Hi-Resolution Sound Quality (DSEE HX)

DSEE HX upscales existing sound sources to near hi-resolution sound quality, and it makes you feel as if you are in a recording studio or at a concert. This function is only available when [Music] is selected as the sound field (page 24).

1 Press HOME.

The home menu appears on the TV screen.

2 Select [Setup] from the home menu.

The setup display appears on the TV screen.

3 Select [Audio Settings] - [DSEE HX].

4 Select [On].

Notes

- This function is compatible with the 2-channel digital input signals of 44.1 kHz or 48 kHz sampling frequency.
- The sampling frequency/bit depth after upscaling is up to 96 kHz/24 bit.
- This function is not compatible with DSD signals.
- This function does not work for the analog input.
- This function does not work when using the wireless surround function or Chromecast built-in.

Enjoying Multiplex Broadcast Sound (AUDIO)

You can enjoy multiplex broadcast sound when the system receives a Dolby Digital multiplex broadcast signal.

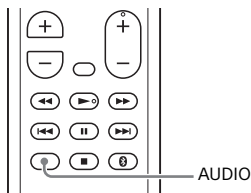

1 Press AUDIO.

The audio signal appears in the front panel display.

2 Press the button repeatedly to select the desired audio signal.

| Audio signal | Explanation |
|--------------|--|
| "MAIN" | Sound of the main language will be output. |
| "SUB" | Sound of the sub language will be output. |
| "MN/SB" | Mixed sound of both the main and sub languages will be output. |

Notes

- To receive a Dolby Digital signal, you need to connect a TV or other devices to the TV IN (OPT) jack with the optical digital cable (supplied).
- If your TV's HDMI IN jack is compatible with the Audio Return Channel function (page 45), you can receive a Dolby Digital signal via HDMI cable.

Deactivating Buttons on the Main Unit

You can deactivate buttons on the main unit for preventing misoperation, such as child mischief (Child lock function).

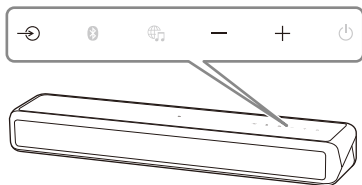

Press **-**, **+**, and **-** in order while pressing and holding **↻** on the main unit.

"LOCK" appears in the front panel display, and buttons on the main unit do not work.

You can only operate the system by using the remote control.

Canceling the Child Lock Function

Press **-**, **+**, and **-** in order while pressing and holding **↻** on the main unit.

"UNLCK" appears in the front panel display, and the child lock function is canceled.

Note

⏻ (power) is not locked with the child lock function.

Changing the Brightness of the Front Panel Display and BLUETOOTH Indicator (DIMMER)

You can change the brightness of the front panel display and BLUETOOTH indicator.

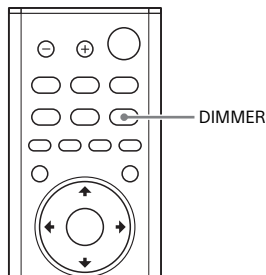

- 1 Press DIMMER.**
The display mode appears in the front panel display.
- 2 Press the button repeatedly to select the desired display mode.**

| Mode | Explanation |
|----------|---|
| "BRIGHT" | The front panel display and BLUETOOTH indicator light brightly. |
| "DARK" | The front panel display and BLUETOOTH indicator light darkly. |
| "OFF" | The front panel display is turned off. |

Note

The front panel display is turned off when "OFF" is selected. It turns on automatically when you press any button, then turns off again if you do not operate the system for about 10 seconds. However, in some cases, the front panel display may not turn off. In this case, the brightness of the front panel display is same as "DARK."

Saving Power in Standby Mode

Check that you have made the following settings:

- [Bluetooth Standby] is set to [Off] (page 50).
- [Quick Start/Network Standby] is set to [Off] (page 51).

Sending the Remote Signal to the TV via the Main Unit

When the main unit obstructs the remote control sensor of the TV, the TV remote control may not work. In that case, enable the IR repeater function of the system.

You can control the TV with the remote control of the TV by sending the remote signal from the rear of the main unit.

1 Press HOME.

The home menu appears on the TV screen.

2 Select [Setup] from the home menu.

The setup display appears on the TV screen.

3 Select [System Settings] - [IR-Repeater].

The [IR-Repeater] screen appears on the TV screen.

4 Select [On].

Notes

- Be sure to check that the remote control of the TV cannot control the TV, and then set [IR-Repeater] to [On]. If it is set to [On] when the remote control can control the TV, appropriate operation may not be obtained because of the interference between the direct command from the remote control and the command via the main unit.
- On some TVs, this function may not work correctly. In this case, place the main unit slightly further away from the TV.

Using the Control for HDMI Function

Connecting a device such as a TV or Blu-ray Disc player compatible with the Control for HDMI function* by HDMI cable enables you to easily operate the device by a TV remote control. The following functions can be used with the Control for HDMI function.

- System Power Off function
- System Audio Control function
- TV Audio Input Mode
- One-Touch Play function
- Menu Operation by TV Remote Control

Note

These functions may work with devices other than those manufactured by Sony, but operation is not guaranteed.

* Control for HDMI is a standard used by CEC (Consumer Electronics Control) for allowing HDMI (High-Definition Multimedia Interface) devices to control each other.

Preparing to Use the Control for HDMI Function

Turn [System Settings] - [HDMI Settings] - [Control for HDMI] on the system to [On] (page 51). The default setting is [On].

Enable the Control for HDMI function settings for the TV and other device connected to the system.

Tip

If you enable the Control for HDMI ("BRAVIA" sync) function when using a TV manufactured by Sony, the Control for HDMI function of the system is also enabled automatically. When settings are completed, "DONE" appears in the front panel display.

System Power Off Function

When you turn off the TV, the system will turn off automatically.

Set [System Settings] - [HDMI Settings] - [Standby Linked to TV] on the system to [On] or [Auto] (page 51). The default setting is [Auto].

System Audio Control Function

If you turn on the system while you are watching the TV, the TV sound will be output from the speakers of the system. The volume of the system can be adjusted using the TV's remote control. If the TV sound was output from the speakers of the system the previous time you watched the TV, the system will be turned on automatically when you turn on the TV again. Operations can also be made by the TV's menu. For details, refer to the operating instructions of your TV.

Notes

- Sound is only output from the TV if other than [TV] input is selected when using the Twin Picture function on the TV. When you disable the Twin Picture function, the sound is output from the system.
- The number for the system's volume level is displayed on the TV screen depending on the TV. The volume number displayed on the TV may differ from the number on the front panel display of the system.
- Depending on the settings of the TV, the System Audio Control function may not be available. For details, refer to the operating instructions of your TV.

TV Audio Input Mode

If the system is connected to a TV's HDMI IN jack compatible with Audio Return Channel (ARC), you can listen to

TV sound from the speakers of the system without connecting an optical digital cable.

On the system, turn [System Settings] - [HDMI Settings] - [TV Audio Input Mode] to [Auto] (page 51). The default setting is [Auto].

Note

If the TV is not compatible with Audio Return Channel, the optical digital cable (supplied) needs to be connected (refer to the supplied Startup Guide).

One-Touch Play Function

When you play content on a device (Blu-ray Disc player, "PlayStation4," etc.) connected to the TV, the system and TV are turned on automatically, the input of the system is switched to the input for the TV, and sound is output from the speakers of the system.

Note

Depending on the TV, the beginning part of content being played may not play correctly.

Menu Operation by TV Remote Control

You can select the system using the SYNC MENU button on the TV remote control and operate the system. This function can be used if the TV supports the link menu. For details, refer to the operating instructions of your TV.

Notes

- In the TV's link menu, the system is recognized by the TV as "Player."
- Some operations may not be available with some TVs.

Using the "BRAVIA" Sync Function

In addition to the Control for HDMI function, you can also use the following functions on devices compatible with the "BRAVIA" sync function.

- Scene Select function
- Home Theatre Control
- Echo Canceling function
- Language Follow

Note

These functions are proprietary functions of Sony. This function cannot operate with products other than those manufactured by Sony.

Scene Select Function

The sound field of the system is automatically switched according to the TV's Scene Select function settings. For details, refer to the operating instructions of your TV.

Set the sound field to [ClearAudio+] (page 24).

Home Theatre Control Function

When using a TV compatible with the Home Theatre Control function, setting the system, setting the sound field settings, input switching, etc. can be done without switching the TV input. This function can be used when the TV is connected to the Internet. For details, refer to the operating instructions of your TV.

Echo Canceling Function

Echo is reduced when you use Social Viewing function such as Skype while watching TV programs. This function can be used if the TV supports Social Viewing function. For details, refer to the operating instructions of your TV.

Notes

- Sound is only output from the speaker of the TV if the input of the system is other than [TV] when using the Social Viewing function.
- This function cannot be used when sound is output from the TV.

Language Follow

When you change the language for the on-screen display of the TV, the system's on-screen display language is also changed.











Notes on HDMI Connections

- Use an HDMI-authorized cable.
- Use a Sony High Speed HDMI Cable with Ethernet with the Cable Type Logo.
- We do not recommend using an HDMI-DVI conversion cable.
- Audio signals (sampling frequency, bit length, etc.) transmitted from an HDMI jack may be suppressed by the connected device.

Using the Setup Display

You can make various adjustments to items such as picture and sound. The default settings are underlined.

- 1 Press HOME.**
The home menu appears on the TV screen.
- 2 Select  [Setup] from the home menu.**
The setup display appears on the TV screen.
- 3 Select the setting item.**

| Setting item | Explanation |
|--|---|
|  [Software Update] | Updates the software of the system. (page 49) |
|  [Screen Settings] | Makes the screen settings according to the type of TV. (page 49) |
|  [Audio Settings] | Makes the audio settings according to the type of connection jacks. (page 49) |
|  [Bluetooth Settings] | Makes detailed settings for the BLUETOOTH function. (page 50) |
|  [Wireless Surround Settings] | Makes setting for the wireless surround function. (page 51) |
|  [System Settings] | Makes the system-related settings. (page 51) |
|  [Network Settings] | Makes detailed settings for the Internet and home network. (page 52) |
|  [Input Skip Setting] | Sets the input skip setting for each input. (page 53) |
|  [Easy Setup] | Re-runs the Easy Setup to make the basic settings. (page 53) |
|  [Resetting] | Resets the system to the factory default settings. (page 53) |

[Software Update]

By updating your software to the latest version, you can take advantage of the newest functions.

For information about update functions, visit the following website:
www.sony.eu/support

Notes

- An Internet environment is necessary to perform updates via Internet.
- During a software update, "UPDT" appears in the front panel display. After the update is complete, the system automatically reboots. While the updating operation is in progress, do not turn on or off the system or operate the system or TV. Wait for the software update to complete.
- Set [Auto Update] to [On] when you want to perform software updates automatically (page 52). Software update may be performed even if you select [Off] in [Auto Update] depending on the details of the updates.

[Update via Internet]

Updates the system's software using the available network. Follow the instructions on the screen. Make sure network is connected to the Internet.

[Update via USB Memory]

Updates software using USB memory. Make sure that the software update folder is correctly named "UPDATE."

[Screen Settings]

[Output Video Resolution]

[Auto]: Outputs video signal according to the resolution of the TV or connected device.

[480p/576p]*: Outputs 480p/576p video signal.

* If the color system of the playback content is NTSC, the video signals

resolution can be converted to [480p] only.

[YCbCr/RGB (HDMI)]

[Auto]: Automatically detects the type of external device, and then switches to the matching color setting.

[RGB]: Select this when connecting to a device with an HDCP compliant DVI jack.

[Audio Settings]

[Speaker Settings]

You can perform the speaker settings to obtain the best possible surround sound. For details, see "Customizing the Speaker Settings for Surround Sound" (page 39).

[DSEE HX]

This function is only available when [Music] is selected as the sound field.

[On]: Upscales the audio data to a High-Resolution Audio file and reproduces the clear high-range sound which is often lost (page 42).

[Off]: Off

[Audio DRC]

You can compress the dynamic range of the sound track.

[Auto]: Automatically compresses sound.

[On]: The system reproduces the dolby sound track with the kind of dynamic range that the recording engineer intended.

[Off]: No compression of dynamic range.

[Audio Output]

You can select the output method used for audio signal output.

[Speaker]: Outputs multi-channel sound from the system's speakers only.

[Speaker + HDMI]: Outputs multi-channel sound from the system's

speakers and 2-channel linear PCM signals from the HDMI OUT (ARC) jack.

Note

When [Control for HDMI] is set to [On] (page 51), [Audio Output] is set to [Speaker + HDMI] automatically and this setting cannot be changed.

[Bluetooth Settings]

[Bluetooth Mode]

You can enjoy content from a BLUETOOTH device by using this system or listen to sound from this system by using BLUETOOTH-compatible headphones.

[Receiver]: This system is in receiver mode, which enables it to receive and output audio from the BLUETOOTH device.

[Transmitter]: This system is in transmitter mode, which enables it to send audio to the BLUETOOTH-compatible headphones. If you switch the input of the system, "BT TX" appears on the front panel display.

[Off]: The BLUETOOTH function is turned off and you cannot select the [Bluetooth Audio] input.

Note

You can connect to a BLUETOOTH device* by using the One-touch function even if you have set [Bluetooth Mode] to [Off].

* Only mobile devices such as a smartphone, tablet, WALKMAN®

[Device List]

Displays a list of paired and detected BLUETOOTH devices (SNK device) when [Bluetooth Mode] is set to [Transmitter].

[Bluetooth Standby]

You can set the [Bluetooth Standby] so that the system can be turned on by a BLUETOOTH device even when the

system is in standby mode. This function is only available when you set [Bluetooth Mode] to [Receiver] or [Transmitter].

[On]: The system turns on automatically when you request a BLUETOOTH connection from a paired BLUETOOTH device.

[Off]: Off

[Bluetooth Codec - AAC]

This function is only available when you set [Bluetooth Mode] to [Receiver] or [Transmitter].

[On]: Enable AAC codec.

[Off]: Disable AAC codec.

Notes

- You can enjoy high-quality sound if AAC is enabled and your device supports AAC.
- When connecting BLUETOOTH-compatible headphones, this setting cannot be changed.

[Bluetooth Codec - LDAC]

This function is only available when you set [Bluetooth Mode] to [Receiver] or [Transmitter].

[On]: Enable LDAC codec.

[Off]: Disable LDAC codec.

Notes

- You can enjoy more high-quality sound if LDAC is enabled and your device supports LDAC.
- When connecting BLUETOOTH-compatible headphones, this setting cannot be changed.

[Wireless Playback Quality]

You can set the transmission data rate of LDAC playback. This function is only available when you set [Bluetooth Mode] to [Transmitter] and [Bluetooth Codec - LDAC] to [On].

[Auto]: The data transfer rate is automatically changed depending on the environment. If audio playback is unstable in this mode, use the other three modes.

[Sound Quality]: The highest bit rate is used. Sound is sent in a higher quality; however, audio playback sometimes may become unstable when the link quality is not good enough.

[Standard]: The middle bit rate is used. It balances both sound quality and playback stability.

[Connection]: Stability is prioritized. Sound quality may be reasonable and connection status will most likely be stable. If the connection is unstable, this setting is recommended.



[Wireless Surround Settings]

This setting is for using wireless speakers (not supplied) as the surround speakers of the system. For details, see "Adding Rear Speakers (Wireless Surround)" (page 37).



[System Settings]

[OSD Language]

You can select the language you want for the system on-screen display.

[Wireless Subwoofer Connection]

You can perform wireless connection of the subwoofer again. For details, see "Performing the Wireless Connection of the Subwoofer (SECURE LINK)" (page 40).

[IR-Repeater]

[On]: Remote signals for the TV are sent from the rear of the main unit (page 44).

[Off]: Turns off the function.

For details, see "Sending the Remote Signal to the TV via the Main Unit" (page 44).

[HDMI Settings]

- [Control for HDMI] (page 45)

[On]: The Control for HDMI function is enabled. Devices connected with an HDMI cable can control each other.

[Off]: Off

- [Standby Linked to TV] (page 45)

This function is available when you set [Control for HDMI] to [On].

[Auto]: If the input of the system is [TV], the system turns off automatically when you turn off the TV.

[On]: The system turns off automatically when you turn off the TV regardless of the input.

[Off]: The system does not turn off when you turn off the TV.

- [TV Audio Input Mode] (page 45)

Set this function when the system is connected to a TV's HDMI IN jack that is compatible with Audio Return Channel. The Audio Return Channel function is available when you set [Control for HDMI] to [On].

[Auto]: You can listen to TV sound from the speakers of the system.

[Optical]: Use this setting when an optical digital cable is connected.

[Quick Start/Network Standby]

[On]: Shortens the startup time from standby mode. You can turn on the system by a device linked via a network when the system is in standby mode.

[Off]: Off

[Auto Standby]

[On]: Turns on the [Auto Standby] function. When you do not operate the system for about 20 minutes, the system enters standby mode automatically.

[Off]: Off

[Software Update Notification]

[On]: Sets the system to inform you of latest software version information (page 49).
[Off]: Off

[Auto Update Settings]

- [Auto Update]
[On]: Software update is automatically executed between 2 a.m. and 5 a.m. local time in the selected [Time Zone] while this system is not in use. If you select [Off] in [Quick Start/Network Standby], software update is performed after you turn off the system.
[Off]: Off
- [Time Zone]
Select your country/region.

Notes

- Software update may be performed even if you select [Off] in [Auto Update] depending on the details of the updates.
- Software update is performed automatically within 11 days of a new software release.

[Device Name]

You can change the name of this system according to your preference so that it is more recognizable when using the [Bluetooth Audio] function. The name is also used with other networks, such as the home network. Follow on-screen instructions and use the software keyboard to enter the name.

[System Information]

You can display the system's software version information and the MAC address.

[Software License Information]

You can display the Software License Information.

[Network Settings]

[Internet Settings]

Connect the system to the network beforehand.

[Wired Setup]: Select this when you connect to a broadband router using a LAN cable. When you select this setting, the wireless LAN function of the system is disabled automatically.

[Wireless Setup]: Select this when you use the built-in Wi-Fi function of the system to connect to a wireless network.

Tip

For further details, visit the following website and check the FAQ:
www.sony.eu/support

[Network Connection Status]

Displays the current network connection status.

[Network Connection Diagnostics]

You can run the network diagnostic to check if the network connection has been made properly.

[Connection Server Settings]

Sets whether or not to display the connected home network server.

[Auto Home Network Access Permission]

[On]: Allows automatic access from a newly detected home network controller.
[Off]: Off

[Home Network Access Control]

Displays a list of home network controller-compatible products and sets whether or not to accept commands from the controllers in the list.

[External Control]

[On]: Allows the home automation controller to operate this system.

[Off]: Off

[Input Skip Setting]

The skip setting is a convenient feature that allows you to skip unused inputs when selecting a function by pressing INPUT +/-.

[Do not skip]: The system does not skip the selected input.

[Skip]: The system skips the selected input.

Note

When you press INPUT +/- during the home menu is displayed, input icon appears dimmed if it has been set to [Skip].

Tip

You can perform [Input Skip Setting] from the options menu (page 54).

[Easy Setup]

Run [Easy Setup] to make the basic initial settings and the basic network settings for the system. Follow the on-screen instructions.

[Resetting]

[Reset to Factory Default Settings]

You can reset the system settings to the factory default by selecting the group of settings. All the settings within the group will be reset.

[Initialise Personal Information]

You can erase your personal information stored on the system.

Note

If you dispose, transfer or resell this system, please delete all Personal Information for security purposes. Please take appropriate measures such as logging out after using a network service.

Options Menu List

Various settings and playback operations are available by pressing **OPTIONS**. The available items differ depending on the situation.

| Item | Explanation |
|-----------------------------|---|
| [Sound Field] | Changes the sound field setting (page 24). |
| [Night] | Selects the night mode (page 25). |
| [Voice] | Selects the voice mode (page 25). |
| [Input Skip Setting] | Skips unused inputs when selecting a function by pressing INPUT +/- (page 53). |
| [Repeat Setting] | Sets repeat playback. |
| [Shuffle Setting] | Sets shuffle playback. |
| [Play/Stop] | Starts or stops playback. |
| [Play from start] | Plays the item from the beginning. |

Troubleshooting

If you experience any of the following difficulties while using the system, use this troubleshooting guide to help remedy the problem before requesting repairs. Should any problem persist, consult your nearest Sony dealer.

Be sure to bring both your main unit and subwoofer, even if it seems as though only one has a problem, when you request to repair.

Power

The system does not power up.

- Check that the AC power cord (mains lead) is connected securely.
- Disconnect the AC power cord (mains lead) from the wall outlet (mains), and then reconnect after several minutes.

The system does not turn on even when the TV is turned on.

- Set [System Settings] - [HDMI Settings] - [Control for HDMI] to [On] (page 51). The TV must support the Control for HDMI function (page 45). For details, refer to the operating instructions of your TV.
- Check the speaker settings of the TV. The system power syncs with the speaker settings of the TV. For details, refer to the operating instructions of your TV.
- If the sound was output from the speakers of the TV the previous time, the system does not turn on even when the TV is turned on.

The system turns off when the TV is turned off.

- Check the setting of [System Settings] - [HDMI Settings] - [Standby Linked to TV] (page 51). When [Standby Linked to TV] is set to [On], the system turns off automatically when you turn off the TV regardless of the input.

The system does not turn off even when the TV is turned off.

- Check the setting of [System Settings] - [HDMI Settings] - [Standby Linked to TV] (page 51). To turn the system off automatically regardless of the input when you turn off the TV, set [Standby Linked to TV] to [On]. The TV must support the Control for HDMI function (page 45). For details, refer to the operating instructions of your TV.

Picture

There is no picture or the picture is not output correctly.

- Select the appropriate input (page 15).
- When there is no picture while TV input is selected, select the TV channel that you want using the TV's remote control.
- Disconnect the HDMI cable, then connect it again. Make sure that the cable is firmly inserted.
- While pressing and holding , press +, -, + on the main unit in order to set the video output resolution setting to the lowest level.
- The system is connected to an input device that is not HDCP (High-bandwidth Digital Content Protection) compliant. In this case, check the specifications of the connected device.

An image is not displayed on the entire TV screen.

- The aspect ratio on the media is fixed.

Sound

No TV sound is output from the system.

- Check the type and connection of the HDMI cable, optical digital cable, or analog audio cable that is connected to the system and the TV (refer to the supplied Startup Guide).
- When the system and TV are connected with a HDMI cable, check the following.
 - The HDMI jack of the connected TV is labeled with "ARC."
 - The Control for HDMI function of the TV is set to on.
 - On the system, [Control for HDMI] is set to [On] and [TV Audio Input Mode] to [Auto] (page 51).
- If your TV is not compatible with Audio Return Channel, connect the optical digital cable (supplied) (refer to the supplied Startup Guide). If the TV is not compatible with Audio Return Channel, TV sound will not be output from the system even if the system is connected to the TV's HDMI IN jack.
- Switch the input of the system to [TV]. When you connect the system and TV with an analog audio cable (not supplied), switch input of the system to [Analog] (page 15).
- Increase the volume on the system or cancel muting.
- Depending on the order in which you connect the TV and the system, the system may be muted and "MUTING" is displayed on the front panel display of the system. If this happens, turn on the TV first, then the system.
- Set the speakers setting of the TV (BRAVIA) to Audio System. Refer to

the operating instructions of your TV regarding how to set the TV.

The sound is output from both the system and the TV.

- Mute the sound of the system or the TV.

The TV sound from this system lags behind the image.

- Set "SYNC" to 0 msec if it is set to the range between 25 msec and 300 msec (page 26).

No sound or only very low-level sound of the device connected to the system is heard.

- Press \triangleleft + on the remote control and check the volume level (page 13).
- Press \otimes or \triangleleft + on the remote control to cancel the muting function (page 13).
- Make sure the input source is selected correctly. You should try other input sources by pressing INPUT +/- on the remote control several times (page 13).
- Check that all the cables and cords of the system and the connected device are firmly inserted.

The surround effect cannot be obtained.

- Depending on the input signal and the sound field setting, surround sound processing may not work effectively. The surround effect may be subtle, depending on the program or disc.
- To play multi-channel audio, check the digital audio output setting on the device connected to the system. For details, refer to the operating instructions supplied with the connected device.

The sound is delayed behind the picture.

- When the sound of the [TV] or [Analog] input is played in the

wireless multi room function, the sound is delayed behind the picture. If you are bothered by a time gap between the sound and picture, cancel the wireless multi room function.

Subwoofer

No sound or only very low-level sound is heard from the subwoofer.

- Press SW \triangleleft + on the remote control to increase the subwoofer volume (page 26).
- Make sure that the power indicator on the subwoofer is lit in green or orange.
- If the power indicator on the subwoofer does not light, try the following.
 - Make sure the AC power cord (mains lead) of the subwoofer is connected properly.
 - Press \downarrow (power) of the subwoofer to turn on the power.
- If the power indicator on the subwoofer flashes slowly in green or orange, or lights in red, try the following.
 - Move the subwoofer to a location near the main unit so that the power indicator on the subwoofer lights in green or orange.
 - Follow the steps in “Performing the Wireless Connection of the Subwoofer (SECURE LINK)” (page 40).
- The power indicator on the subwoofer flashes quickly in green.
 - Consult your nearest Sony dealer.
- If the power indicator on the subwoofer flashes in red, press \downarrow (power) of the subwoofer to turn off the power and check whether the ventilation holes of the subwoofer is blocked or not.
- The subwoofer is for reproducing bass sound. In the case of input

sources that contain very little bass sound components (i.e., a TV broadcast), the sound from the subwoofer may be difficult to hear.

- Set the night mode to [Off]. For details, see “Enjoying Clear Sound with Low Volume at Midnight (NIGHT)” (page 25).

Sound skips or has noise.

- If there is a device nearby that generates electromagnetic waves, such as a wireless LAN or a microwave oven in use, locate the system apart from it.
- If there is an obstacle between the main unit and the subwoofer, move or remove it.
- Locate the main unit and the subwoofer as close as possible.
- Switch the wireless LAN frequency of any nearby wireless LAN router or PC to 5 GHz range.
- Switch the network connection of the TV or Blu-ray Disc Player from wireless to wired.

USB Device Connection

The USB device is not recognized.

- Try the following:
 - ① Turn the system off.
 - ② Remove and reconnect the USB device.
 - ③ Turn the system on.
- Make sure that the USB device is securely connected to the \downarrow (USB) port (page 23).
- Check to see if the USB device or a cable is damaged.
- Make sure that the USB device is on.
- If the USB device is connected via a USB hub, disconnect it and connect the USB device directly to the system.

Mobile Device Connection

BLUETOOTH connection cannot be completed.

- Make sure that the BLUETOOTH indicator of the main unit is lit (page 28).
- Make sure the BLUETOOTH device to be connected with is turned on and the BLUETOOTH function is enabled.
- Bring this system and the BLUETOOTH device closer together.
- Pair this system and the BLUETOOTH device again. You may need to cancel the pairing with this system using your BLUETOOTH device first.
- Pairing information may be deleted. Perform pairing operation again (page 27).

Pairing cannot be achieved.

- Bring this system and the BLUETOOTH device closer together.
- Make sure this system is not receiving interference from a wireless LAN device, other 2.4 GHz wireless devices, or a microwave oven. If a device that generates electromagnetic radiation is nearby, move the device away from this system.

You cannot use the NFC function.

- The NFC function does not work with BLUETOOTH-compatible headphones. To listen to sound using a BLUETOOTH-compatible headphones, see "Listening to Sound of the Connected TV or Device from Headphones" (page 30).

Sound of the connected BLUETOOTH mobile device is not output from the system.

- Make sure that the BLUETOOTH indicator of the main unit is lit (page 28).
- Bring this system and the BLUETOOTH device closer together.

- If a device that generates electromagnetic radiation, such as a wireless LAN device, other BLUETOOTH devices, or a microwave oven is nearby, move the device away from this system.
- Remove any obstacle between this system and the BLUETOOTH device or move this system away from the obstacle.
- Reposition the connected BLUETOOTH device.
- Switch the wireless LAN frequency of any nearby wireless LAN router or PC to 5 GHz range.
- Increase the volume on the connected BLUETOOTH device.

Headphones Connection via BLUETOOTH

BLUETOOTH connection cannot be completed.

- Make sure that the BLUETOOTH indicator of the main unit is lit (page 10).
- Make sure the BLUETOOTH device to be connected with is turned on and the BLUETOOTH function is enabled.
- Bring this system and the BLUETOOTH device closer together.
- Pair this system and the BLUETOOTH device again. You may need to cancel the pairing with this system using your BLUETOOTH device first.
- Pairing information may be deleted. Perform pairing operation again (page 30).

Pairing cannot be achieved.

- Bring this system and the BLUETOOTH device closer together.
- Make sure this system is not receiving interference from a wireless LAN device, other 2.4 GHz wireless devices, or a microwave oven. If a device that generates electromagnetic radiation is nearby,

move the device away from this system.

You cannot use the NFC function.

- The NFC function does not work with BLUETOOTH-compatible headphones. To listen to sound using a BLUETOOTH-compatible headphones, see "Listening to Sound of the Connected TV or Device from Headphones" (page 30).

No sound is output from the connected BLUETOOTH headphones.

- Make sure that the BLUETOOTH indicator of the main unit is lit (page 10).
- Bring this system and the BLUETOOTH device closer together.
- If a device that generates electromagnetic radiation, such as a wireless LAN device, other BLUETOOTH devices, or a microwave oven is nearby, move the device away from this system.
- Remove any obstacle between this system and the BLUETOOTH device or move this system away from the obstacle.
- Reposition the connected BLUETOOTH device.
- Switch the wireless LAN frequency of any nearby wireless LAN router or PC to 5 GHz range.
- Increase the volume on the connected BLUETOOTH device.
- Set [Wireless Playback Quality] to [Connection] (page 50).

Wired LAN Connection

The system cannot connect to the network.

- Check the network connection (page 18) and the network settings (page 52).

Wireless LAN Connection

You cannot connect your PC to the Internet after [Wi-Fi Protected Setup™ (WPS)] is performed.

- The wireless settings of the router may change automatically if you use the Wi-Fi Protected Setup function before adjusting the settings of the router. In this case, change the wireless settings of your PC accordingly.

The system cannot connect to the network or the network connection is unstable.

- Make sure the wireless LAN router is on.
- Check the network connection (page 19) and the network settings (page 52).
- Depending on the usage environment (including the wall material), radio wave reception conditions, or obstacles between the system and the wireless LAN router, the possible communication distance may be shortened. Move the system and the wireless LAN router closer to each other.
- Devices that use a 2.4 GHz frequency band, such as a microwave, BLUETOOTH, or digital cordless device, may interrupt communication. Move the main unit away from such devices, or turn off such devices.
- The wireless LAN connection may be unstable depending on the usage environment, especially while using the BLUETOOTH function of the system. In this case, adjust the usage environment.
- The wireless LAN function is not available when using the wireless surround function.

The wireless LAN router you want is not shown in the wireless network list.

- Press BACK to return to the previous screen, and try [Wireless Setup] again (page 19). If the wireless LAN router you want is still not detected, select [New connection registration] from the network list, then select [Manual registration] to input a network name (SSID) manually.

Internet Connection

You cannot connect the system to the Internet.

- Check the wired or wireless LAN connection.
- Restart the router or wireless LAN router.

Wireless Surround

No sound or only very low-level sound is heard from the wireless speaker.

- Depending on the input signal, a surround effect with presence may not be obtained. Depending on the program or disc, audio signals for the surround channels are output at a very low level.
- When you play content compatible with copyright protection technology (HDCP, etc.), it may not be output from the wireless speaker.
- Check the surround speakers connection on [Wireless Surround Settings] - [Surround Speaker Connection Check].
- Adjust the volume level of the surround speakers on [Audio Settings] - [Speaker Settings].

The sound is delayed behind the picture.

- When using the wireless surround function, the sound may be delayed.

The system cannot connect to the network.

- The wireless LAN function is not available when using the wireless surround function. Connect to the network via wired LAN.

The wireless speakers cannot be connected to the system.

- Update the software version of the system and wireless speakers to the latest version.

Wireless Multi Room

The sound is delayed behind the picture.

- When the sound of the [TV] or [Analog] input is played in the wireless multi room function, the sound is delayed behind the picture. This function is for enjoying the sound of the device that is connected to the system in different rooms. If you are bothered by a time gap between the sound and picture, cancel the wireless multi room function.

Remote Control

The remote control of this system does not function.

- Point the remote control at the remote control sensor on the main unit (page 10).
- Remove any obstacles in the path between the remote control and the system.
- Replace both batteries in the remote control with new ones, if they are weak.

- Make sure you are pressing the correct button on the remote control.

TV remote control does not work.

- This problem might be solved by enabling the IR repeater function (page 51).

Others

The Control for HDMI function does not work properly.

- Check the connection with the system (refer to the supplied Startup Guide).
- Enable the Control for HDMI function on the TV. For details, refer to the operating instructions of your TV.
- Wait a while, and then try again. If you unplug the system, it will take a while before operations can be made. Wait for 15 seconds or longer, and then try again.
- The type and number of devices that can be controlled by the Control for HDMI function is restricted by the HDMI CEC standard as follows:
 - Recording devices (Blu-ray Disc recorder, DVD recorder, etc.): up to 3 devices
 - Playback devices (Blu-ray Disc player, DVD player, etc.): up to 3 devices (this system uses one of them)
 - Tuner-related devices: up to 4 devices
 - Audio system (receiver/headphone): up to 1 device (used by this system)

“PRTCT,” “PUSH” and “POWER” flash alternately in the front panel display.

- Press  (power) to turn off the system. After the indicator disappears, disconnect the AC power cord (mains lead) and make sure

nothing is obstructing the ventilation holes of the system.

“BT TX” appears in the front panel display.

- Press BLUETOOTH RX/TX on the remote control to switch [Bluetooth Mode] to [Receiver]. “BT TX” appears if [Bluetooth Mode] is set to [Transmitter] (page 50). When you press BLUETOOTH RX/TX on the remote control, [Bluetooth Mode] is switched to [Receiver] and the selected input appears in the front panel display.

Sensors of the TV do not work properly.

- The main unit may block some sensors (such as the brightness sensor), the remote control receiver of your TV or the emitter for 3D glasses (infrared transmission) of a 3D TV that supports the infrared 3D glass system, or wireless communication. Move the main unit away from the TV within a range that allow those parts to operate properly. For the locations of the sensors and remote control receiver, refer to the operating instructions supplied with the TV.

Wireless functions (wireless LAN, BLUETOOTH, or subwoofer) are unstable.

- Do not place metal objects other than a TV around the system.

Music that you are not familiar with is played suddenly.

- The pre-installed sample music may have been played. Press  on the main unit to stop playback.

The system does not work properly.

- The system may be in demo mode. To cancel demo mode, reset the system. Press and hold  (power) and – on the main unit for more than 5 seconds (page 62).

Resetting the System

If the system still does not operate properly, reset the system as follows.

- 1 Press HOME.**
The home menu appears on the TV screen.
- 2 Select  [Setup] from the home menu.**
The setup display appears on the TV screen.
- 3 Select [Resetting] - [Reset to Factory Default Settings].**
- 4 Select the menu item you want to reset.**
- 5 Select [Start].**

To cancel resetting

Select [Cancel] in step 5.

If You Cannot Perform Resetting Using the Home Menu

Press and hold  (power) and - on the main unit for more than 5 seconds.

The settings return to their initial status.

Note

By resetting, the link with the subwoofer may be lost. In this case, perform "Performing the Wireless Connection of the Subwoofer (SECURE LINK)" (page 40).

Additional Information

Specifications

Bar Speaker (SA-MT500, SA-MT501)

Amplifier section

POWER OUTPUT (rated)

Front L + Front R: 25 W + 25 W
(at 4 ohms, 1 kHz, 1% THD)

POWER OUTPUT (reference)

Front L/Front R speaker blocks: 35 W
(per channel at 4 ohms, 1 kHz)

Inputs

ANALOG IN
TV IN (OPT)

Outputs

HDMI OUT (TV (ARC))

HDMI Section

Connector

Type A (19pin)

USB section

⚡ (USB) port:

Type A (For connecting USB memory)

LAN section

LAN(100) terminal

100BASE-TX Terminal

Wireless LAN section

Communication system

IEEE 802.11 a/b/g/n

Frequency band

2.4 GHz, 5 GHz

BLUETOOTH section

Communication system

BLUETOOTH Specification version 4.1

Output

BLUETOOTH Specification Power
Class 1

Maximum communication range

Line of sight approx. 30 m¹⁾

Maximum number of devices to be

registered
9 devices

Frequency band

2.4 GHz band (2.4 GHz - 2.4835 GHz)

Modulation method

FHSS (Freq Hopping Spread Spectrum)

Compatible BLUETOOTH profiles²⁾

A2DP 1.2 (Advanced Audio Distribution Profile)

AVRCP 1.5 (Audio Video Remote Control Profile)

Supported Codecs³⁾

SBC⁴⁾, AAC⁵⁾, LDAC

Transmission range (A2DP)

20 Hz - 40,000 Hz (LDAC sampling frequency 96 kHz with 990 kbps transmission)

20 Hz - 20,000 Hz (Sampling frequency 44.1 kHz)

- 1) The actual range will vary depending on factors such as obstacles between devices, magnetic fields around a microwave oven, static electricity, cordless phone use, reception sensitivity, the operating system, software applications, etc.
- 2) BLUETOOTH standard profiles indicate the purpose of BLUETOOTH communication between devices.
- 3) Codec: Audio signal compression and conversion format
- 4) Abbreviation for Subband Codec
- 5) Abbreviation for Advanced Audio Coding

Front L/Front R speaker block section

Speaker system

Full range speaker system, Acoustic suspension

Speaker

45 mm cone type

General

Power requirements

DC 19.5 V (using the supplied AC adapter connected to AC 100 V - 240 V, 50 Hz/60Hz power supply)

Power consumption (using the supplied

AC adapter)

On: 30 W

For details about the power consumption during standby mode, see "Power Consumption by the Setting Value for Each Standby Mode" (page 65).

Dimensions* (approx.) (w/h/d)

500 mm × 64 mm × 108 mm
(without grille frame)

500 mm × 64 mm × 110 mm
(with grille frame)

*Not including projection portion
Mass (approx.)
2 kg

Compatible iPod/iPhone models

The compatible iPod/iPhone models are as follows. Update your iPod/iPhone with the latest software before using with the system.

BLUETOOTH technology works with:
iPhone 7 Plus/iPhone 7/iPhone SE/iPhone
6s Plus/iPhone 6s/iPhone 6 Plus/
iPhone 6/iPhone 5s/iPhone 5c/iPhone 5/
iPhone 4s
iPod touch (6th generation)/iPod touch
(5th generation)

Subwoofer (SA-WMT500, SA-WMT501)

POWER OUTPUT (reference)
85 W (at 4 ohms, 100 Hz)
Speaker system
Subwoofer speaker system, Bass
reflex
Speaker
160 mm cone type
Power requirements
220 V - 240 V AC, 50 Hz/60 Hz
Power consumption
On: 20 W
Standby mode: 0.5 W or less
Dimensions (approx.) (w/h/d)
95 mm × 383 mm × 380 mm (not
including projection portion)
Mass (approx.)
6.6 kg

Wireless transmitter/ receiver section

Communication system
Wireless Sound Specification version
3.0
Frequency band
5.2 GHz (5.180 GHz - 5.240 GHz)
5.8 GHz (5.736 GHz - 5.814 GHz)
Modulation method
DSSS

Design and specifications are subject to
change without notice.

Power Consumption by the Setting Value for Each Standby Mode

| Standby mode | Default setting | Setting value | |
|---|----------------------|------------------------|----------------------|
| | | [Off] | [On] |
| [Bluetooth Standby] (page 50) | [On] | [Off] | [On] |
| [Quick Start/Network Standby] (page 51) | [Off] | [Off] | [On] |
| Power consumption | Less than 2 W | Less than 0.5 W | Less than 7 W |

Notes

- Wi-Fi port and Ethernet port of the system have router function which can forward audio data to some other Sony audio product.
- When [Quick Start/Network Standby] is set to [Off], the wireless LAN function is disabled in standby mode.
- When [Bluetooth Mode] is set to [Off], the BLUETOOTH function is disabled.

Playable Types of Files

Music

| Codec | Extension |
|--|--|
| MP3 (MPEG-1 Audio Layer III) ¹⁾ | .mp3 |
| AAC/HE-AAC ^{1),2)} | .m4a, .aac ³⁾ , .mp4, .3gp |
| WMA9 Standard ²⁾ | .wma |
| WMA10 Pro ⁴⁾ | .wma |
| LPCM ¹⁾ | .wav |
| FLAC ²⁾ | .flac, .fla |
| Dolby Digital ^{1),3)} | .ac3 |
| DSF ²⁾ | .dsf |
| DSDIFF ^{2),5)} | .dff |
| AIFF ²⁾ | .aiff, .aif |
| ALAC ²⁾ | .m4a |
| Vorbis | .ogg |
| Monkey's Audio | .ape |

1) The system can play “.mka” files. These files cannot be played on a home network server.

2) The system may not play this file format on a home network server.

3) The system does not play this file format on a home network server.

4) The system does not play Lossless coded files.

5) The system does not play DST encoded files.

Notes

- Some files may not play depending on the file format, the file encoding, the recording condition, or the home network server condition.
- Some files edited on a PC may not play.
- Fast forward or fast reverse may not be available with some files.
- The system does not play coded files such as DRM.
- The system can recognize the following files or folders in USB devices:
 - up to folders in the 9th layer (including the root folder)

- up to 500 files/folders in a single layer
- The system can recognize the following files or folders stored in the home network server:
 - up to folders in the 19th layer
 - up to 999 files/folders in a single layer
- Some USB devices may not work with this system.
- The system can recognize Mass Storage Class (MSC) devices (such as flash memory or an HDD) and 101-key keyboards.

Supported Input Audio Formats

Audio formats supported by this system are as follows.

| Format | Function |
|----------------------------------|-------------------|
| | "TV" (DIGITAL IN) |
| LPCM 2ch | ○ |
| LPCM 5.1ch | - |
| LPCM 7.1ch | - |
| Dolby Digital | ○ |
| Dolby TrueHD, Dolby Digital Plus | - |
| DTS | ○ |
| DSD | - |

○: Supported format.

-: Unsupported format.

On BLUETOOTH Communication

- BLUETOOTH devices should be used within approximately 10 meters (33 feet) (unobstructed distance) of each other. The effective communication range may become shorter under the following conditions:
 - When a person, metal object, wall or other obstruction is between the devices with a BLUETOOTH connection
 - Locations where a wireless LAN is installed
 - Around microwave ovens that are in use
 - Locations where other electromagnetic waves occur
- BLUETOOTH devices and wireless LAN (IEEE 802.11 b/g/n) use the same frequency band (2.4 GHz). When using your BLUETOOTH device near a device with wireless LAN capability, electromagnetic interference may occur. This could result in lower data transfer rates, noise, or inability to connect. If this happens, try the following remedies:
 - Use this system at least 10 meters (33 feet) away from the wireless LAN device.
 - Turn off the power to the wireless LAN device when using your BLUETOOTH device within 10 meters (33 feet).
 - Install this system and BLUETOOTH device as close to each other as possible.
- The radio waves broadcast by this system may interfere with the operation of some medical devices. Since this interference may result in malfunction, always turn off the power on this system and BLUETOOTH device in the following locations:
 - In hospitals, on trains, in airplanes, at gas stations, and any place where flammable gasses may be present
 - Near automatic doors or fire alarms
- This system supports security functions that comply with the BLUETOOTH specification to ensure secure connection

during communication using BLUETOOTH technology. However, this security may be insufficient depending on the setting content and other factors, so always be careful when performing communication using BLUETOOTH technology.

- Sony cannot be held liable in any way for damages or other loss resulting from information leaks during communication using BLUETOOTH technology.
- BLUETOOTH communication is not necessarily guaranteed with all BLUETOOTH devices that have the same profile as this system.
- BLUETOOTH devices connected with this system must comply with the BLUETOOTH specification prescribed by the Bluetooth SIG, Inc., and must be certified to comply. However, even when a device complies with the BLUETOOTH specification, there may be cases where the characteristics or specifications of the BLUETOOTH device make it impossible to connect, or may result in different control methods, display or operation.
- Noise may occur or the audio may cut off depending on the BLUETOOTH device connected with this system, the communications environment, or surrounding conditions.

If you have any questions or problems concerning your system, please consult your nearest Sony dealer.

END USER LICENSE AGREEMENT

IMPORTANT:

BEFORE USING THE SOFTWARE, PLEASE READ THIS END USER LICENSE AGREEMENT (“EULA”) CAREFULLY. BY USING THE SOFTWARE YOU ARE ACCEPTING THE TERMS OF THIS EULA. IF YOU DO NOT ACCEPT THE TERMS OF THIS EULA, YOU MAY NOT USE THE SOFTWARE.

This EULA is a legal agreement between you and Sony Corporation (“SONY”). This EULA governs your rights and obligations regarding the SONY software of SONY and/or its third party licensors (including SONY’s affiliates) and their respective affiliates (collectively, the “THIRD-PARTY SUPPLIERS”), together with any updates/upgrades provided by SONY, any printed, on-line or other electronic documentation for such software, and any data files created by operation of such software (collectively, the “SOFTWARE”).

Notwithstanding the foregoing, any software in the SOFTWARE having a separate end user license agreement (including, but not limited to, GNU General Public license and Lesser/Library General Public License) shall be covered by such applicable separate end user license agreement in lieu of the terms of this EULA to the extent required by such separate end user license agreement (“EXCLUDED SOFTWARE”).

SOFTWARE LICENSE

The SOFTWARE is licensed, not sold. The SOFTWARE is protected by copyright and other intellectual property laws and international treaties.

COPYRIGHT

All right and title in and to the SOFTWARE (including, but not limited to, any images, photographs, animation, video, audio, music, text and “applets” incorporated into the SOFTWARE) is owned by SONY or one or more of the THIRD-PARTY SUPPLIERS.

GRANT OF LICENSE

SONY grants you a limited license to use the SOFTWARE solely in connection with your compatible device (“DEVICE”) and only for your individual, non-commercial use. SONY and the THIRD-PARTY SUPPLIERS expressly reserve all rights, title and interest (including, but not limited to, all intellectual property rights) in and to the SOFTWARE that this EULA does not specifically grant to you.

REQUIREMENTS AND LIMITATIONS

You may not copy, publish, adapt, redistribute, attempt to derive source code, modify, reverse engineer, decompile, or disassemble any of the SOFTWARE, whether in whole or in part, or create any derivative works from or of the SOFTWARE unless such derivative works are intentionally facilitated by the SOFTWARE. You may not modify or tamper with any digital rights management functionality of the SOFTWARE. You may not bypass, modify, defeat or circumvent any of the functions or protections of the SOFTWARE or any mechanisms operatively linked to the SOFTWARE. You may not separate any individual component of the SOFTWARE for use on more than one DEVICE unless expressly authorized to do so by SONY. You may not remove, alter, cover or deface any trademarks or notices on the SOFTWARE. You may not share, distribute, rent, lease, sublicense, assign, transfer or sell the SOFTWARE.

The software, network services or other products other than SOFTWARE upon which the SOFTWARE'S performance depends might be interrupted or discontinued at the discretion of the suppliers (software suppliers, service suppliers, or SONY). SONY and such suppliers do not warrant that the SOFTWARE, network services, contents or other products will continue to be available, or will operate without interruption or modification.

USE OF SOFTWARE WITH COPYRIGHTED MATERIALS

The SOFTWARE may be capable of being used by you to view, store, process and/or use content created by you and/or third parties. Such content may be protected by copyright, other intellectual property laws, and/or agreements. You agree to use the SOFTWARE only in compliance with all such laws and agreements that apply to such content. You acknowledge and agree that SONY may take appropriate measures to protect the copyright of content stored, processed or used by the SOFTWARE. Such measures include, but are not limited to, counting the frequency of your backup and restoration through certain SOFTWARE features, refusal to accept your request to enable restoration of data, and termination of this EULA in the event of your illegitimate use of the SOFTWARE.

CONTENT SERVICE

PLEASE ALSO NOTE THAT THE SOFTWARE MAY BE DESIGNED TO BE USED WITH CONTENT AVAILABLE THROUGH ONE OR MORE CONTENT SERVICES ("CONTENT SERVICE"). USE OF THE SERVICE AND THAT CONTENT IS SUBJECT TO THE TERMS OF SERVICE OF THAT CONTENT SERVICE. IF YOU DECLINE TO ACCEPT THOSE TERMS, YOUR USE OF THE SOFTWARE WILL BE LIMITED. You acknowledge and agree

that certain content and services available through the SOFTWARE may be provided by third parties over which SONY has no control. USE OF THE CONTENT SERVICE REQUIRES AN INTERNET CONNECTION. THE CONTENT SERVICE MAY BE DISCONTINUED AT ANY TIME.

INTERNET CONNECTIVITY AND THIRD PARTY SERVICES

You acknowledge and agree that access to certain SOFTWARE features may require an Internet connection for which you are solely responsible. Further, you are solely responsible for payment of any third party fees associated with your Internet connection, including but not limited to Internet service provider or airtime charges. Operation of the SOFTWARE may be limited or restricted depending on the capabilities, bandwidth or technical limitations of your Internet connection and service. The provision, quality and security of such Internet connectivity are the sole responsibility of the third party providing such service.

EXPORT AND OTHER REGULATIONS

You agree to comply with all applicable export and re-export restrictions and regulations of the area or country in which you reside, and not to transfer, or authorize the transfer, of the SOFTWARE to a prohibited country or otherwise in violation of any such restrictions or regulations.

HIGH RISK ACTIVITIES

The SOFTWARE is not fault-tolerant and is not designed, manufactured or intended for use or resale as on-line control equipment in hazardous environments requiring fail-safe performance, such as in the operation of nuclear facilities, aircraft navigation or communication systems, air traffic

control, direct life support machines, or weapons systems, in which the failure of the SOFTWARE could lead to death, personal injury, or severe physical or environmental damage ("HIGH RISK ACTIVITIES"). SONY, each of the THIRD-PARTY SUPPLIERS, and each of their respective affiliates specifically disclaim any express or implied warranty, duty or condition of fitness for HIGH RISK ACTIVITIES.

EXCLUSION OF WARRANTY ON SOFTWARE

You acknowledge and agree that use of the SOFTWARE is at your sole risk and that you are responsible for use of the SOFTWARE. The SOFTWARE is provided "AS IS," without warranty, duty or condition of any kind.

SONY AND EACH OF THE THIRD-PARTY SUPPLIERS (for purposes of this Section, SONY and each of the THIRD-PARTY SUPPLIERS shall be collectively referred to as "SONY") EXPRESSLY DISCLAIM ALL WARRANTIES, DUTIES OR CONDITIONS, EXPRESS OR IMPLIED, INCLUDING, BUT NOT LIMITED TO, THE IMPLIED WARRANTIES OF MERCHANTABILITY, NONINFRINGEMENT AND FITNESS FOR A PARTICULAR PURPOSE. SONY DOES NOT WARRANT OR MAKE ANY CONDITIONS OR REPRESENTATIONS (A) THAT THE FUNCTIONS CONTAINED IN ANY OF THE SOFTWARE WILL MEET YOUR REQUIREMENTS OR THAT THEY WILL BE UPDATED, (B) THAT THE OPERATION OF ANY OF THE SOFTWARE WILL BE CORRECT OR ERROR-FREE OR THAT ANY DEFECTS WILL BE CORRECTED, (C) THAT THE SOFTWARE WILL NOT DAMAGE ANY OTHER SOFTWARE, HARDWARE OR DATA, (D) THAT ANY SOFTWARE, NETWORK SERVICES (INCLUDING THE INTERNET) OR PRODUCTS (OTHER THAN THE SOFTWARE) UPON WHICH THE SOFTWARE'S PERFORMANCE DEPENDS WILL CONTINUE TO BE AVAILABLE,

UNINTERRUPTED OR UNMODIFIED, AND (E) REGARDING THE USE OR THE RESULTS OF THE USE OF THE SOFTWARE IN TERMS OF ITS CORRECTNESS, ACCURACY, RELIABILITY, OR OTHERWISE.

NO ORAL OR WRITTEN INFORMATION OR ADVICE GIVEN BY SONY OR AN AUTHORIZED REPRESENTATIVE OF SONY SHALL CREATE A WARRANTY, DUTY OR CONDITION OR IN ANY WAY INCREASE THE SCOPE OF THIS WARRANTY. SHOULD THE SOFTWARE PROVE DEFECTIVE YOU ASSUME THE ENTIRE COST OF ALL NECESSARY SERVICING, REPAIR OR CORRECTION. SOME JURISDICTIONS DO NOT ALLOW THE EXCLUSION OF IMPLIED WARRANTIES, SO THESE EXCLUSIONS MAY NOT APPLY TO YOU.

LIMITATION OF LIABILITY

SONY AND EACH OF THE THIRD-PARTY SUPPLIERS (for purposes of this Section, SONY and each of the THIRD-PARTY SUPPLIERS shall be collectively referred to as "SONY") SHALL NOT BE LIABLE FOR ANY INCIDENTAL OR CONSEQUENTIAL DAMAGES FOR BREACH OF ANY EXPRESS OR IMPLIED WARRANTY, BREACH OF CONTRACT, NEGLIGENCE, STRICT LIABILITY OR UNDER ANY OTHER LEGAL THEORY RELATED TO THE SOFTWARE, INCLUDING, BUT NOT LIMITED TO, ANY DAMAGES ARISING OUT OF LOSS OF PROFITS, LOSS OF REVENUE, LOSS OF DATA, LOSS OF USE OF THE SOFTWARE OR ANY ASSOCIATED HARDWARE, DOWN TIME AND USER'S TIME, EVEN IF ANY OF THEM HAVE BEEN ADVISED OF THE POSSIBILITY OF SUCH DAMAGES. IN ANY CASE, EACH AND ALL OF THEIR AGGREGATE LIABILITY UNDER ANY PROVISION OF THIS EULA SHALL BE LIMITED TO THE AMOUNT ACTUALLY PAID FOR THE PRODUCT. SOME JURISDICTIONS DO NOT ALLOW THE EXCLUSION OR LIMITATION OF INCIDENTAL OR CONSEQUENTIAL

DAMAGES, SO THE ABOVE EXCLUSION OR LIMITATION MAY NOT APPLY TO YOU.

AUTOMATIC UPDATE FEATURE

From time to time, SONY or the THIRD-PARTY SUPPLIERS may automatically update or otherwise modify the SOFTWARE, including, but not limited to, for purposes of enhancement of security functions, error correction and improvement of functions, at such time as you interact with SONY's or third parties' servers, or otherwise. Such updates or modifications may delete or change the nature of features or other aspects of the SOFTWARE, including, but not limited to, functions you may rely upon. You acknowledge and agree that such activities may occur at SONY's sole discretion and that SONY may condition continued use of the SOFTWARE upon your complete installation or acceptance of such update or modifications. Any updates/modifications shall be deemed to be, and shall constitute part of, the SOFTWARE for purposes of this EULA. By acceptance of this EULA, you consent to such update/modification.

ENTIRE AGREEMENT, WAIVER, SEVERABILITY

This EULA and SONY's privacy policy, each as amended and modified from time to time, together constitute the entire agreement between you and SONY with respect to the SOFTWARE. The failure of SONY to exercise or enforce any right or provision of this EULA shall not constitute a waiver of such right or provision. If any part of this EULA is held invalid, illegal, or unenforceable, that provision shall be enforced to the maximum extent permissible so as to maintain the intent of this EULA, and the other parts will remain in full force and effect.

GOVERNING LAW AND JURISDICTION

The United Nations Convention on Contracts for the International Sale of Goods shall not apply to this EULA. This EULA shall be governed by the laws of Japan, without regards to conflict of laws provisions. Any dispute arising out of this EULA shall be subject to the exclusive venue of the Tokyo District Court in Japan, and the parties hereby consent to the venue and jurisdiction of such courts.

EQUITABLE REMEDIES

Notwithstanding anything contained in this EULA to the contrary, you acknowledge and agree that any violation of or non-compliance with this EULA by you will cause irreparable harm to SONY, for which monetary damages would be inadequate, and you consent to SONY obtaining any injunctive or equitable relief that SONY deems necessary or appropriate in such circumstances. SONY may also take any legal and technical remedies to prevent violation of and/or to enforce this EULA, including, but not limited to, immediate termination of your use of the SOFTWARE, if SONY believes in its sole discretion that you are violating or intend to violate this EULA. These remedies are in addition to any other remedies SONY may have at law, in equity or under contract.

TERMINATION

Without prejudice to any of its other rights, SONY may terminate this EULA if you fail to comply with any of its terms. In case of such termination, you must cease all use, and destroy any copies, of the SOFTWARE.

AMENDMENT

SONY RESERVES THE RIGHT TO AMEND ANY OF THE TERMS OF THIS EULA AT ITS

SOLE DISCRETION BY POSTING NOTICE ON A SONY DESIGNATED WEB SITE, BY EMAIL NOTIFICATION TO AN EMAIL ADDRESS PROVIDED BY YOU, BY PROVIDING NOTICE AS PART OF THE PROCESS IN WHICH YOU OBTAIN UPGRADES/UPDATES OR BY ANY OTHER LEGALLY RECOGNIZABLE FORM OF NOTICE. If you do not agree to the amendment, you should promptly contact SONY for instructions. Your continued use of the SOFTWARE after the effective date of any such notice shall be deemed your agreement to be bound by such amendment.

THIRD-PARTY BENEFICIARIES

Each THIRD-PARTY SUPPLIER is an express intended third-party beneficiary of, and shall have the right to enforce, each provision of this EULA with respect to the SOFTWARE of such party.

Should you have any questions concerning this EULA, you may contact SONY by writing to SONY at applicable contact address of each area or country.

Copyright © 2014 Sony Corporation.

Precautions

On safety

- Should any solid object or liquid fall into the system, unplug the system and have it checked by qualified personnel before operating it any further.
- Do not climb on the main unit and subwoofer, as you may fall down and injure yourself, or system damage may result.

On power sources

- Before operating the system, check that the operating voltage is identical to your local power supply. The operating voltage is indicated on the nameplate at the bottom of the main unit.
- If you are not going to use the system for a long time, be sure to disconnect the system from the wall outlet (mains). To disconnect the AC power cord (mains lead), grasp the plug itself; never pull the cord.
- One blade of the plug is wider than the other for the purpose of safety and will fit into the wall outlet (mains) only one way. If you are unable to insert the plug fully into the outlet, contact your dealer.
- AC power cord (mains lead) must be changed only at a qualified service shop.

On heat buildup

Although the system heats up during operation, this is not a malfunction. If you continuously use this system at high volume, the system temperature at the rear and bottom rises considerably. To avoid burning yourself, do not touch the system.

On placement

- Do not place the system near heat sources or in a place subject to direct sunlight, excessive dust, or mechanical shock.
- Do not place anything at the rear of the main unit and subwoofer that might block

the ventilation holes and cause malfunctions.

- Do not place metal objects other than a TV around the system. Wireless functions may be unstable.
- If the system is being used in combination with a TV, VCR, or tape deck, noise may result and picture quality may suffer. In such a case, place the system away from the TV, VCR, or tape deck.
- Use caution when placing the system on a surface that has been specially treated (with wax, oil, polish, etc.), as staining or discoloration of the surface may result.
- Take care to avoid any possible injury from the corners of the main unit and subwoofer.
- The speakers of this system are not of magnetically shielded type. Do not place magnetic cards on the system or near it.
- When installing the subwoofer under a sofa, you may feel sick due to vibration of the subwoofer. In this case, adjust the subwoofer volume or install the subwoofer in a location other than under a sofa.

On operation

Before connecting other devices, be sure to turn off and unplug the system.

If you encounter color irregularity on a nearby TV screen

Color irregularities may be observed on certain types of TV sets.

If color irregularity is observed...

Turn off the TV set, then turn it on again after 15 to 30 minutes.

If color irregularity is observed again...

Place the system further away from the TV set.

On cleaning

Clean the system with a soft, dry cloth. Do not use any type of abrasive pad, scouring powder, or solvent such as alcohol or benzene.

If you have any question or problem concerning your system, please consult your nearest Sony dealer.

Disclaimer regarding services offered by third parties

Network services, content and the (operating system and) software of this product may be subject to individual terms and conditions and changed, interrupted or discontinued at any time and may require fees, registration and credit card information.

Notes on updating

This system allows you to update the software automatically when connected to the Internet via a wired or wireless network.

You can add new features and use the system with more convenience and safety by updating the system.

If you do not want to update automatically, you can disable the function by using SongPal installed on your smartphone or tablet. However, the system may update the software automatically for reasons such as safety, even if this function is disabled. You can also update the software using the settings menu when this function is disabled. See "Using the Setup Display" (page 48) for details.

You may not use the system while the software is being updated.

Copyrights and Trademarks

This system incorporates Dolby* Digital and the DTS** Digital Surround System.

* Manufactured under license from Dolby Laboratories.

Dolby, Dolby Audio and the double-D symbol are trademarks of Dolby Laboratories.

**For DTS patents, see <http://patents.dts.com>. Manufactured under license from DTS Licensing Limited. DTS, the Symbol, & DTS and the Symbol together are registered trademarks, and DTS Digital Surround is a trademark of DTS, Inc. © DTS, Inc. All Rights Reserved.

The BLUETOOTH® word mark and logos are registered trademarks owned by Bluetooth SIG, Inc. and any use of such marks by Sony Corporation is under license. Other trademarks and trade names are those of their respective owners.

This system incorporates High-Definition Multimedia Interface (HDMI™) technology. The terms HDMI and HDMI High-Definition Multimedia Interface, and the HDMI Logo are trademarks or registered trademarks of HDMI Licensing, LLC in the United States and other countries.

The N Mark is a trademark or registered trademark of NFC Forum, Inc. in the United States and in other countries.

Android, Google Play and Chromecast are trademarks of Google Inc.

Apple, the Apple logo, iPhone, iPod, iPod touch, and Retina are trademarks of Apple Inc., registered in the U.S. and other countries. App Store is a service mark of Apple Inc.

"Made for iPod," and "Made for iPhone" mean that an electronic accessory has been designed to connect specifically to iPod or iPhone, respectively, and has been certified by the developer to meet Apple

performance standards. Apple is not responsible for the operation of this device or its compliance with safety and regulatory standards. Please note that the use of this accessory with iPod or iPhone may affect wireless performance.

"BRAVIA" logo is a trademark of Sony Corporation.

"ClearAudio+" is a trademark of Sony Corporation.

WALKMAN® and WALKMAN® logo are registered trademarks of Sony Corporation.

"PlayStation" is a registered trademark or trademark of Sony Interactive Entertainment Inc.

MPEG Layer-3 audio coding technology and patents licensed from Fraunhofer IIS and Thomson.

Windows Media is either a registered trademark or trademark of Microsoft Corporation in the United States and/or other countries.

This product is protected by certain intellectual property rights of Microsoft Corporation. Use or distribution of such technology outside of this product is prohibited without a license from Microsoft or an authorized Microsoft subsidiary.

Opera® Devices SDK from Opera Software ASA. Copyright 1995-2016 Opera Software ASA. All rights reserved.



Wi-Fi®, Wi-Fi Protected Access® and Wi-Fi Alliance® are registered trademarks of Wi-Fi Alliance.

Wi-Fi CERTIFIED™, WPA™, WPA2™ and Wi-Fi Protected Setup™ are trademarks of Wi-Fi Alliance.

LDAC™ and LDAC logo are trademarks of Sony Corporation.

LDAC is an audio coding technology developed by Sony that enables the transmission of High-Resolution (Hi-Res) Audio content, even over a Bluetooth connection. Unlike other Bluetooth compatible coding technologies such as SBC, it operates without any down-conversion of the Hi-Res Audio content*, and allows approximately three times more data** than those other technologies to be transmitted over a Bluetooth wireless network with unprecedented sound quality, by means of efficient coding and optimized packetization.

* excluding DSD format contents

**in comparison with SBC (Subband Coding) when the bitrate of 990 kbps (96/48 kHz) or 909 kbps (88.2/44.1 kHz) is selected

This product contains software that is subject to the GNU General Public License ("GPL") or GNU Lesser General Public License ("LGPL"). These establish that customers have the right to acquire, modify, and redistribute the source code of said software in accordance with the terms of the GPL or the LGPL.

For details of the GPL, LGPL and other software licenses, please refer to [Software License Information] in [System Settings] of the [Setup] menu on the product.

The source code for the software used in this product is subject to the GPL and LGPL, and is available on the Web. To download, please access the following:

URL:

<http://oss.sony.net/Products/Linux>

Please note that Sony cannot answer or respond to any inquiries regarding the content of this source code.

"DSEE HX" is a trademark of Sony Corporation.

DLNA™, the DLNA Logo and DLNA CERTIFIED™ are trademarks, service marks, or certification marks of the Digital Living Network Alliance.

This product incorporates Spotify software which is subject to 3rd party licenses found here*:

<https://developer.spotify.com/esdk-third-party-licenses/>

Spotify and Spotify logos are trademarks of the Spotify Group.*

* Depending on the country and region, this function may not be available.

All other trademarks are trademarks of their respective owners.

Index

A

- Audio DRC 49
- Audio Output 49
- Audio Return Channel (ARC) 45, 51
- Audio Settings 49
- Auto Home Network Access
 - Permission 52
- Auto Standby 51
- Auto Update 52
- Auto Update Settings 52

B

- Bluetooth Codec - AAC 50
- Bluetooth Codec - LDAC 50
- Bluetooth Mode 50
- Bluetooth Settings 50
- Bluetooth Standby 44, 50

C

- Child lock function 43
- Connection Server Settings 52
- Control for HDMI 45, 51

D

- Device List 50
- Device Name 52
- DSEE HX 49

E

- Easy Setup 53
- External Control 53

H

- HDMI Settings 51
- Home Network Access Control 52

I

- Initialise Personal Information 53
- Input Skip Setting 53
- Internet Settings 52
- IR-Repeater 51

M

- Multiplex broadcast sound 42

N

- Network 18
- Network Connection Diagnostics 52
- Network Connection Status 52
- Network Settings 52
- NFC 28

O

- OSD Language 51
- Output Video Resolution 49

P

- PRTCT 61

Q

- Quick Start/Network Standby 44, 51

R

- Remote control 13, 44
- Reset to Factory Default Settings 53, 62
- Resetting 53, 62

S

- Screen Settings 49
- Software License Information 52
- Software Update 49
- Software Update Notification 52
- SongPal 33
- Speaker Settings 49
- Subwoofer 26, 40, 57
- System Information 52
- System Settings 51

T

- Time Zone 52
- TV Audio Input Mode 51

U

- Update 49

W

- Wireless Playback Quality 50
- Wireless Subwoofer Connection 51

Y

YCbCr/RGB (HDMI) 49

The software of this system may be updated in the future. To find out details on any available updates, please visit the following URL.
www.sony.eu/support



* 4 6 8 7 8 1 0 3 2 * (1)