

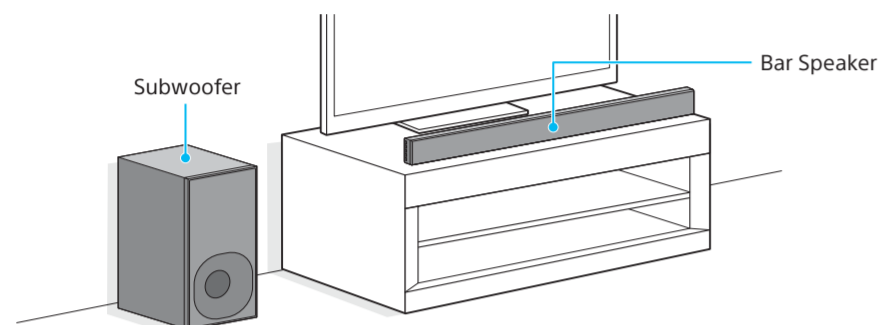

Sound Bar
Startup Guide

HT-NT3

Supplied accessories

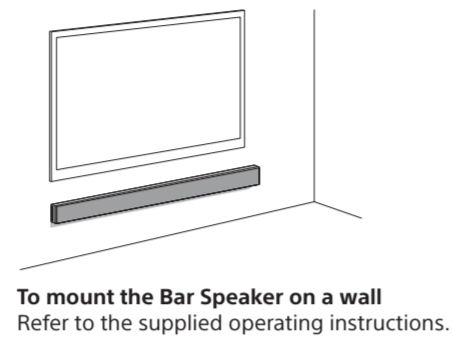

1 Connecting with a TV

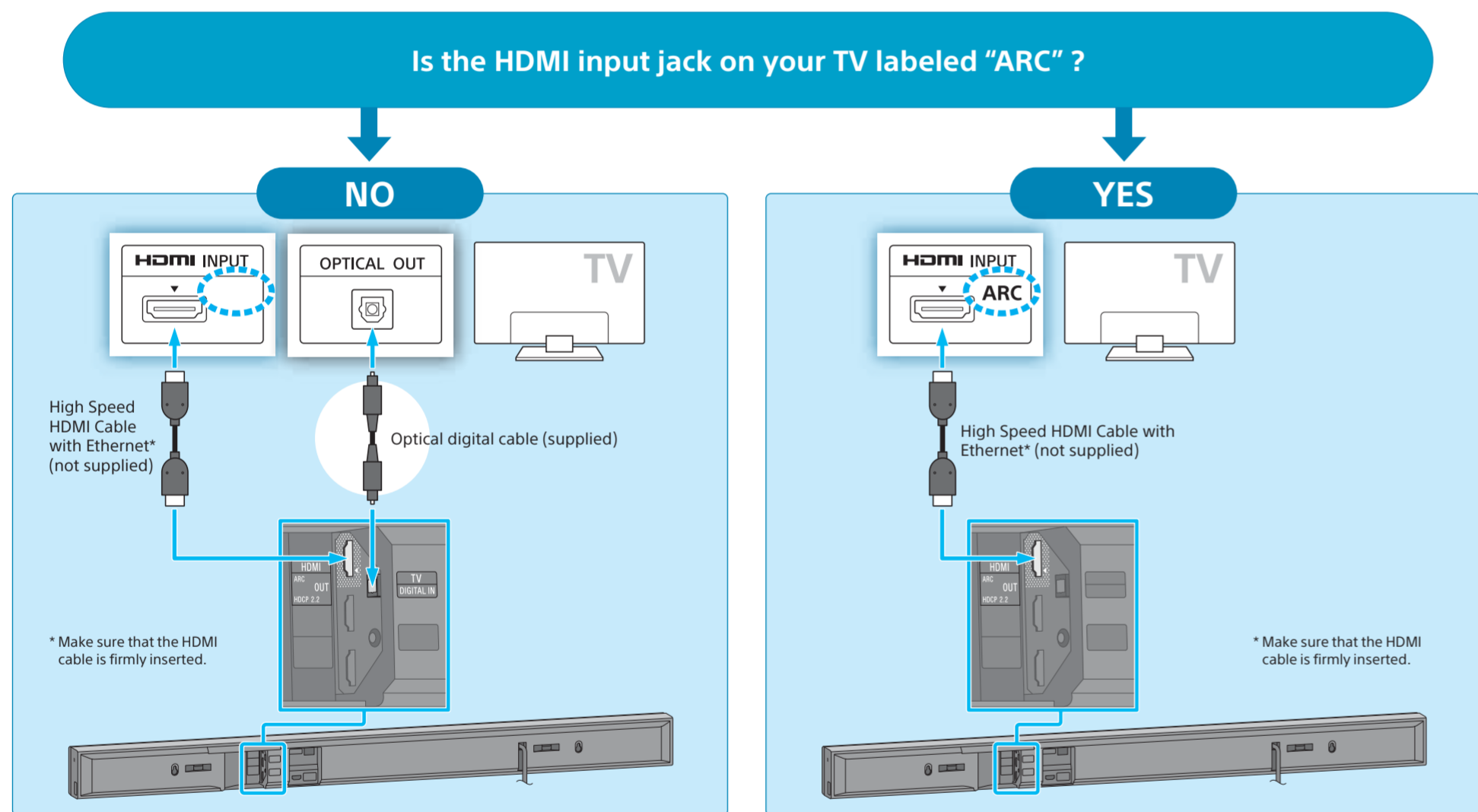

2 Connecting with other devices

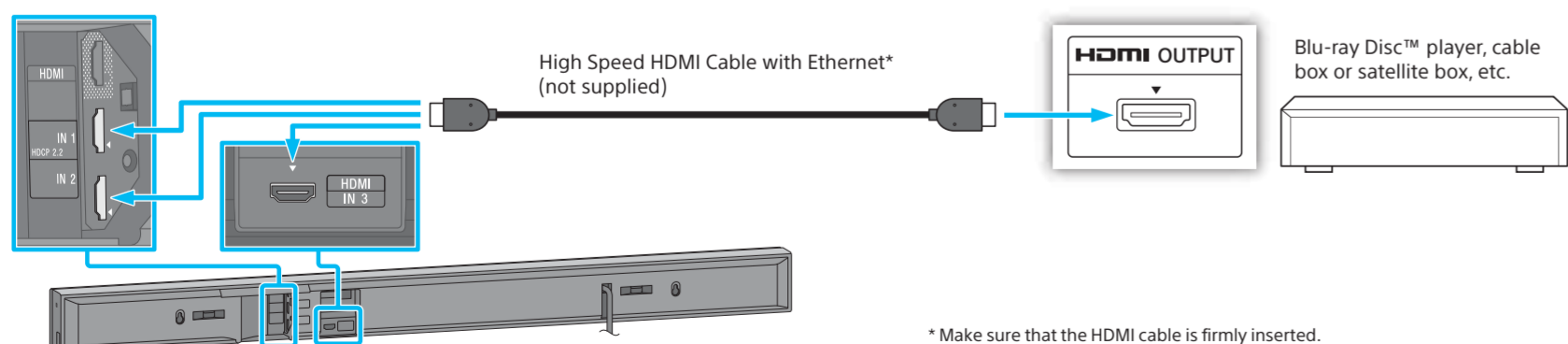

Tip To enjoy copyright-protected 4K content, connect the HDCP 2.2-compatible HDMI jack. For details, refer to "Viewing Copyright-protected 4K Content" in the supplied operating instructions.

3 Setting up the remote control

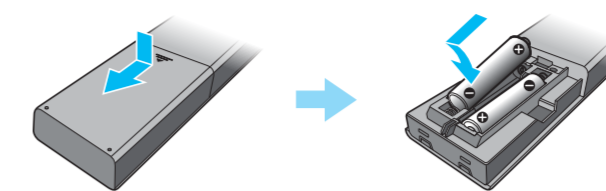

4 Turning on the system

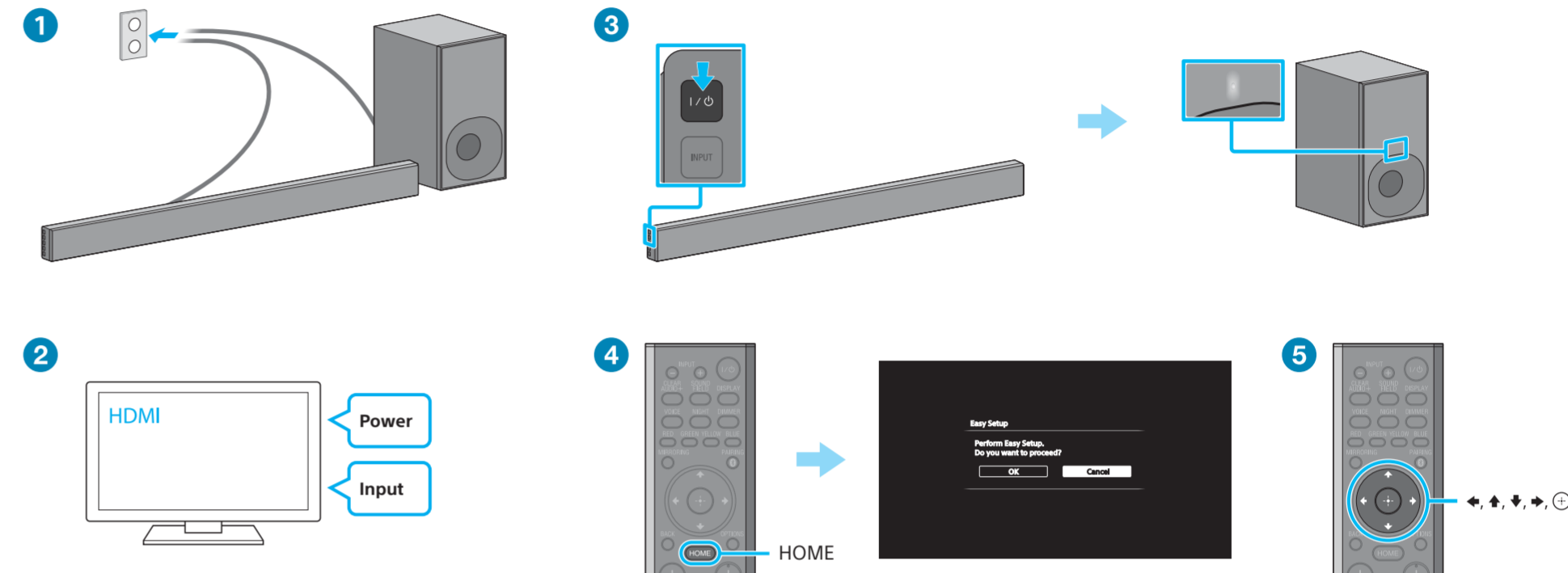

- 1 Connect the AC power cords (mains leads).
- 2 Turn on the TV and then change the input of the TV to the input to which the Bar Speaker is connected.
- 3 Press I/O (on/standby). The front panel display lights up. When the on/standby indicator of the subwoofer turns green, wireless connection of Bar Speaker and subwoofer is completed. If it does not turn on, the wireless transmission is not activated. Refer to "No sound is heard from the subwoofer." of "Troubleshooting" in the supplied operating instructions.
- 4 Press HOME after "PLEASE WAIT" disappears from the front panel display.
- 5 Press $\blacktriangle/\blacktriangleright$ to select [OK], then press \ominus to start [Easy Setup]. Follow the on-screen instructions to make the basic settings using $\blacktriangle/\blacktriangleright$, $\blacktriangleleft/\blacktriangleleft$ and \ominus .

5 Enjoying video/sound from the connected devices

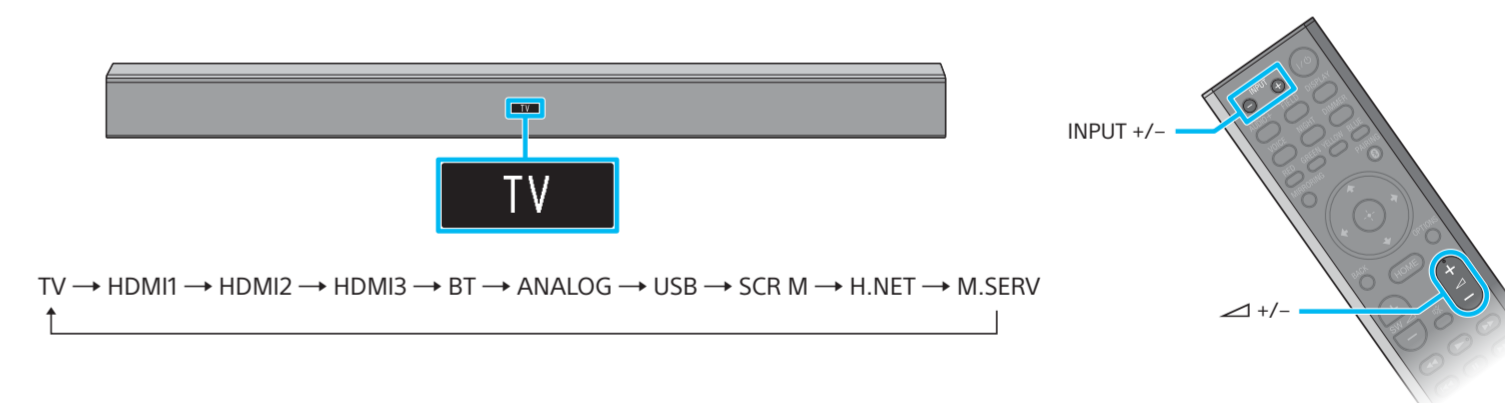

Press INPUT +/- repeatedly until the device you want appears in the front panel display. Then, press \blacktriangleleft +/- repeatedly to adjust the volume. To listen to TV audio, select the program you want using the TV remote control.

Setup completed! Enjoy!

Please refer to the supplied operating instructions for details on the network connection, NFC function, and other functions.

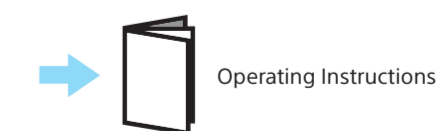

SongPal
A dedicated App for this model is available on both Google Play™ and App Store.
Search for "SongPal" and download the free App to find out more about the convenient features.