

SONY[®]

Home Theatre System

Operating Instructions

WARNING

Do not install the appliance in a confined space, such as a bookcase or built-in cabinet.

To reduce the risk of fire, do not cover the ventilation opening of the appliance with newspapers, tablecloths, curtains, etc.

Do not expose the appliance to naked flame sources (for example, lighted candles).

To reduce the risk of fire or electric shock, do not expose this appliance to dripping or splashing, and do not place objects filled with liquids, such as vases, on the appliance.

Do not expose batteries or appliances with battery-installed to excessive heat, such as sunshine and fire.

To prevent injury, this apparatus must be securely placed on the cabinet in accordance with the installation instructions.

Indoor use only.

On power sources

- The unit is not disconnected from the mains as long as it is connected to the AC outlet, even if the unit itself has been turned off.
- As the main plug is used to disconnect the unit from the mains, connect the unit to an easily accessible AC outlet. Should you notice an abnormality in the unit, disconnect the main plug from the AC outlet immediately.

Recommended cables

Properly shielded and grounded cables and connectors must be used for connection to host computers and/or peripherals.

For customers in Europe



Disposal of waste batteries and electrical and electronic equipment (applicable in the European Union and other European countries with separate collection systems)

This symbol on the product, the battery or on the packaging indicates that the product and the battery shall not be treated as household waste. On certain batteries this symbol might be used in combination with a chemical symbol. The chemical symbols for mercury (Hg) or lead (Pb) are added if the battery contains more than 0.0005% mercury or 0.004% lead. By ensuring these products and batteries are disposed of correctly, you will help prevent potentially negative consequences for the environment and human health which could otherwise be caused by inappropriate waste handling. The recycling of the materials will help to conserve natural resources.

In case of products that for safety, performance or data integrity reasons require a permanent connection with an incorporated battery, this battery should be replaced by qualified service staff only. To ensure that the battery and the electrical and electronic equipment will be treated properly, hand over these products at end-of-life to the applicable collection point for the recycling of electrical and electronic equipment. For all other batteries, please view the section on how to remove the battery from the product safely. Hand the battery over to the applicable collection point for the recycling of waste batteries. For more detailed information about recycling of this product or battery, please contact your local Civic Office, your household waste disposal service or the shop where you purchased the product or battery.

Notice for customers: the following information is only applicable to equipment sold in countries applying EU directives.

This product has been manufactured by or on behalf of Sony Corporation, 1-7-1 Konan Minato-ku Tokyo, 108-0075 Japan. Inquiries related to product compliance based on European Union legislation shall be addressed to the authorized representative, Sony Belgium, bijkantoor van Sony Europe Limited, Da Vincilaan 7-D1, 1935 Zaventem, Belgium. For any service or guarantee matters, please refer to the addresses provided in the separate service or guarantee documents.

Hereby, Sony Corp., declares that this equipment is in compliance with the essential requirements and other relevant provisions of Directive 1999/5/EC.

For details, please access the following URL: <http://www.compliance.sony.de/>



This product is intended to be used in the following countries.

AT, BE, BG, HR, CY, CZ, DK, EE, FI, FR, DE, GR, HU, IS, IE, IT, LV, LI, LT, LU, MT, NL, NO, PL, PT, RO, SK, SI, ES, SE, CH, GB, AL, BA, MK, MD, RS, ME, Kosovo

5.15 GHz – 5.35 GHz band is restricted to indoor operations only.

This Home Theatre System is intended for video/sound playback from connected devices, music streaming from an NFC-compatible smartphone or a BLUETOOTH device. This system also supports network streaming and Screen mirroring.

This equipment has been tested and found to comply with the limits set out in the EMC regulation using a connection cable shorter than 3 meters.

For customers in Australia and New Zealand

This equipment should be installed and operated with at least 20 cm and more between the radiator and person's body (excluding extremities: hands, wrists, feet and ankles).

For customers in Australia



Disposal of Old Electrical & Electronic Equipment (Applicable in the European Union and other European countries with separate collection systems)

For customers in Singapore



Copyrights and Trademarks

- This system incorporates Dolby* Digital and the DTS** Digital Surround System.
 - * Manufactured under license from Dolby Laboratories. Dolby and the double-D symbol are trademarks of Dolby Laboratories.
 - ** For DTS patents, see <http://patents.dts.com>. Manufactured under license from DTS Licensing Limited. DTS, DTS-HD, the Symbol, & DTS and the Symbol together are registered trademarks of DTS, Inc. © DTS, Inc. All Rights Reserved.
- This system incorporates High-Definition Multimedia Interface (HDMI™) technology. The terms HDMI and HDMI High-Definition Multimedia Interface, and the HDMI Logo are trademarks or registered trademarks of HDMI Licensing LLC in the United States and other countries.
- "BRAVIA" is a trademark of Sony Corporation.

- “PlayStation” is a registered trademark of Sony Computer Entertainment Inc.
 - Wi-Fi®, Wi-Fi Protected Access®, Wi-Fi Alliance® and Wi-Fi CERTIFIED Miracast® are registered trademarks of Wi-Fi Alliance®.
 - Wi-Fi CERTIFIED™, WPA™, WPA2™, Wi-Fi Protected Setup™ and Miracast™ are trademarks of Wi-Fi Alliance®.
 - The N Mark is a trademark or registered trademark of NFC Forum, Inc. in the United States and in other countries.
 - Android™ is a trademark of Google Inc.
 - Google Play™ is a trademark of Google Inc.
 - Google Cast™ is a trademark of Google Inc.
 - “Xperia” is a trademark of Sony Mobile Communications AB.
 - The BLUETOOTH® word mark and logos are registered trademarks owned by Bluetooth SIG, Inc. and any use of such marks by Sony Corporation is under license. Other trademarks and trade names are those of their respective owners.
 - LDAC™ and LDAC logo are trademarks of Sony Corporation.
 - “DSEE HX” is a trademark of Sony Corporation.
 - MPEG Layer-3 audio coding technology and patents licensed from Fraunhofer IIS and Thomson.
 - Windows Media is either a registered trademark or trademark of Microsoft Corporation in the United States and/ or other countries.
- This product is protected by certain intellectual property rights of Microsoft Corporation. Use or distribution of such technology outside of this product is prohibited without a license from Microsoft or an authorized Microsoft subsidiary.

- Opera® Devices SDK from Opera Software ASA. Copyright 1995-2013 Opera Software ASA. All rights reserved.



- “ClearAudio+” is a trademark of Sony Corporation.
- “x.v.Colour” and “x.v.Colour” logo are trademarks of Sony Corporation.
- Apple, the Apple logo, iPhone, iPod, iPod touch, and Retina are trademarks of Apple Inc., registered in the U.S. and other countries. App Store is a service mark of Apple Inc.

“Made for iPod,” and “Made for iPhone” mean that an electronic accessory has been designed to connect specifically to iPod or iPhone, respectively, and has been certified by the developer to meet Apple performance standards. Apple is not responsible for the operation of this device or its compliance with safety and regulatory standards. Please note that the use of this accessory with iPod or iPhone may affect wireless performance.

Compatible iPod/iPhone models

The compatible iPod/iPhone models are as follows. Update your iPod/iPhone with the latest software before using with the system.

BLUETOOTH technology works with:

- iPhone
 - iPhone 6 Plus/iPhone 6/iPhone 5s/ iPhone 5c/iPhone 5/iPhone 4s/ iPhone 4/iPhone 3GS
- iPod touch
 - iPod touch (5th generation)/iPod touch (4th generation)
- All other trademarks are trademarks of their respective owners.

- Other system and product names are generally trademarks or registered trademarks of the manufacturers. ™ and ® marks are not indicated in this document.

Notice on GNU GPL/LGPL applied software and other Open Source Softwares

This product contains software that is subject to the GNU General Public License ("GPL") or GNU Lesser General Public License ("LGPL"). These establish that customers have the right to acquire, modify, and redistribute the source code of said software in accordance with the terms of the GPL or the LGPL.

For details of the GPL, LGPL and other software licenses, please refer to [Software License Information] in [System Settings] of the [Setup] menu on the product.

The source code for the software used in this product is subject to the GPL and LGPL, and is available on the Web. To download, please access the following: URL:

<http://oss.sony.net/Products/Linux>

Please note that Sony cannot answer or respond to any inquiries regarding the content of this source code.

About These Operating Instructions

- The instructions in these Operating Instructions describe the controls on the remote control. You can also use the controls on the unit if they have the same or similar names as those on the remote control.
- Some illustrations are presented as conceptual drawings, and may be different from the actual products.
- The items displayed on the TV screen may vary depending on the area.
- The default setting is underlined.
- The text enclosed in bracket ([--]) appears on the TV screen, and the text enclosed in double quotation mark ("--") appears in the front panel display.

Table of Contents

Connecting ➔ Startup Guide (separate document)

About These Operating
Instructions5

Listening/Viewing

Enjoying video/sound from the
connected devices8

Playing music/photo from a
USB device8

Listening to music from a
BLUETOOTH device9

Playing music/photo from
other devices via the
network function9

Sound Adjustment

Enjoying sound effects9

Using the DSEE HX function
(Reproducing audio codec
files with natural sound
quality)10

BLUETOOTH Function

Listening to music from a
BLUETOOTH device11

Listening to sound by
transmitting to a
BLUETOOTH-compatible
receiver13

Network Function

Connecting with a wired
network15

Connecting with a wireless
network16

Playing files on a Home
Network16

Enjoying various online
services17

Using Screen mirroring18

Viewing Copyright-protected 4K Content

Connecting a 4K TV19

Connecting 4K devices20

Settings and Adjustments

Using the Setup Display21

Using the Options menu28

Other Functions

Controlling the system using a smartphone or tablet (SongPal)	30
Using the Control for HDMI Function for "BRAVIA" Sync	31
Enjoying multiplex broadcast sound (Dual Mono)	33
Deactivating the touch keys on the unit (Child Lock)	33
Changing the brightness	34
Saving power in Standby Mode	34

Additional Information

Precautions	34
Troubleshooting	36
Guide to Parts and Controls	43
Playable types of files	46
Supported audio formats	47
Specifications	47
On BLUETOOTH communication	50
Index	51
END USER LICENSE AGREEMENT	53

Enjoying video/sound from the connected devices

Press **INPUT +/-**.

You can also press **HOME**, then press **←/→/↑/↓** repeatedly and **+** to select the input you want.

[TV]

Device (TV, etc.) that is connected to the TV (DIGITAL IN) jack, or a TV compatible with the Audio Return Channel function that is connected to the HDMI OUT (ARC) jack

[HDMI1]/[HDMI2]/[HDMI3]

Device that is connected to the HDMI IN 1/2/3 jack

[Bluetooth Audio]

"BT"

BLUETOOTH device that supports A2DP

[Analog]

"ANALOG"

Device (Digital media player, etc.) that is connected to the ANALOG IN jack

[USB]

USB device that is connected to the  (USB) port

[Screen mirroring]

"SCR M"

Screen mirroring-compatible device (page 18)

[Home Network]

"H.NET"

Contents stored on a server (page 16)

[Music Services]

"M.SERV"

Contents of music services offered on the Internet (page 17)

Tip

You can also press **PAIRING**  and **MIRRORING** on the remote control to select [Bluetooth Audio] and [Screen mirroring] input respectively.

Playing music/photo from a USB device

You can play music/photo files on a connected USB device.

For playable types of files, see "Playable types of files" (page 46).

1 Connect the USB device to the (USB) port.

Refer to the operating instructions of the USB device before connecting.

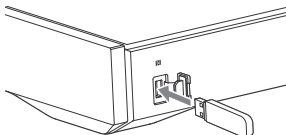

2 Press **HOME**.

The home screen appears on the TV screen.

3 Press **←/→/↑/↓** to select [USB], then press **+**.

4 Press **↑/↓** to select [Music] or [Photo], then press **+**.

5 Press **↑/↓** to select the content you want, then press **+**.

The selected content starts playing.

Note

Do not remove the USB device during operation. To avoid data corruption or damage to the USB device, turn the system off before removing the USB device.

Listening to music from a BLUETOOTH device

See "BLUETOOTH Function" (page 11).

Playing music/photo from other devices via the network function

See "Network Function" (page 15).

Sound Adjustment

Enjoying sound effects

You can easily enjoy pre-programmed sound effects that are tailored to different kinds of sound sources. They bring exciting and powerful sound into your home.

Note

You cannot select the sound effects when the system is connected to a BLUETOOTH receiver in transmitter mode.

Selecting the sound field

Press SOUND FIELD repeatedly during playback.

[ClearAudio+]

You can enjoy the sound with Sony-recommended sound field. Sound field is automatically optimized according to playback content and function.

[Movie]

The system provides the optimized sound for watching movies.

[Music]

The system provides the optimized sound for listening to music.

[Sports]

This system reproduces the feel of sports broadcasting. Commentary is clear, cheers are heard as surround sound, and sounds are realistic.

[Game Studio]

The system provides the optimized sound for playing video games.

[Standard]

The system provides the sound that corresponds to every source.

Tip

- You can also press CLEARAUDIO+ to select [ClearAudio+].
- You can also select [Sound Field] from the Options menu (page 28).

Using the Night mode function

This function is useful when watching movies late at night. You will be able to hear the dialog clearly even at a low volume level.

Press NIGHT.

Night mode function is activated. Press again to cancel the function.

Tip

You can also select [Night] from the Options menu (page 28).

Using the Clear Voice function

This function helps make dialogues clearer.

Press VOICE repeatedly.

- [Voice : 1]: Standard
- [Voice : 2]: Dialogue range is enhanced.
- [Voice : 3]: Dialogue range is enhanced, and the parts of range difficult to be discerned by the elderly are boosted.

Tip

You can also select [Type 1], [Type 2] or [Type 3] in [Voice] from the Options menu (page 28).

Using the DSEE HX function (Reproducing audio codec files with natural sound quality)

DSEE HX upscales existing sound sources to near hi-resolution sound quality, and it makes you feel as if you are really there at the recording studio or concert.

This function only works when [Music] is selected as sound field.

- 1 Press HOME.**
The home screen appears on the TV screen.
- 2 Press \uparrow to select  [Setup] at the upper right corner, then press \oplus .**
- 3 Press \uparrow/\downarrow to select [Audio Settings], then press \oplus .**
- 4 Press \uparrow/\downarrow to select [DSEE HX], then press \oplus .**
- 5 Press \uparrow/\downarrow to select [On], then press \oplus .**

Note

- Only the fine sound restoration feature of the DSEE HX function will be applied to PCM audio sources with lossless compression. The DSEE HX function does not work for DSD (DSDIFF, DSF) format files. The file is expanded to a maximum 96 kHz/24 bit equivalent.
- This function works with 2-channel digital input signals of 44.1 kHz or 48 kHz.
- This function does not work when [Analog] input is selected.
- This function does not work when [Bluetooth Mode] is set to [Transmitter] (page 24).

BLUETOOTH Function

Listening to music from a BLUETOOTH device

Pairing this system with a BLUETOOTH device

Pairing is an operation where BLUETOOTH devices register with each other beforehand. Once a pairing operation is performed, it does not need to be performed again.

Before you pair the device with this system, be sure to set the [Bluetooth Mode] to [Receiver] (page 24).

1 Place the BLUETOOTH device within 1 meter from the unit.

2 Press PAIRING .

The blue LED indicator flashes and the BLUETOOTH pairing screen appears on the TV screen.

Tip

You can also select [Bluetooth Audio] from home screen.

3 Set the BLUETOOTH device in pairing mode.

For details on setting the BLUETOOTH device in pairing mode, refer to the operating instructions supplied with the device.

4 Select "HT-XT3" on the device's display.

Perform this step within 5 minutes, otherwise pairing mode will be canceled.

When the BLUETOOTH connection is established, device name appears on the TV screen and the blue LED indicator lights up.

Note

If passkey is required on the BLUETOOTH device, enter "0000". Passkey may be called "Passcode", "PIN code", "PIN number" or "Password".

Tip

You can change the system's name that appears on your device by using [Device Name] in [System Settings] (page 26).

5 Start playback on the BLUETOOTH device.

6 Adjust the volume.

Adjust the volume of the BLUETOOTH device first, if the volume level is still too low, adjust the volume level on the unit.

Note

You can pair up to 9 BLUETOOTH devices. If the 10th BLUETOOTH device is paired, the least recently connected device will be replaced by the new one.

To cancel pairing operation

Press HOME or INPUT +/-.

Connecting to a BLUETOOTH device from this system

You can connect to the paired BLUETOOTH device from this system. Check the following before playing music:

- The BLUETOOTH function of the BLUETOOTH device is turned on.
- The pairing has been completed (page 11).
- The [Bluetooth Mode] is set to [Receiver] (page 24).

1 Press PAIRING .

Note

To connect to the most recent connected BLUETOOTH device, press . Then proceed to Step 5.

2 Press OPTIONS.

3 Select [Device List], then press .

A list of paired BLUETOOTH devices appears.







4 Press / repeatedly to select the device you want, then press .

5 Press to start playback.

6 Adjust the volume.

Adjust the volume of the BLUETOOTH device first, if the volume level is still too low, adjust the volume level on the unit.

Note

- Once the system and the BLUETOOTH device are connected, you can control playback by pressing , , , / and /.
- You can connect to the system from a paired BLUETOOTH device even when the system is standby mode, if you set the [Bluetooth Standby] to [On] (page 24).
- The audio playback on this system may be delayed from that on the BLUETOOTH device because of the characteristics of the BLUETOOTH wireless technology.

Tip

You can enable or disable codec AAC or LDAC from BLUETOOTH device (page 24).

To disconnect the BLUETOOTH device



Perform any of the following items.



- Press PAIRING  again.
- Disable the BLUETOOTH function on the BLUETOOTH device.



- When playback screen is displayed, press OPTIONS, then select [Disconnect].
- Turn off the system or the BLUETOOTH device.

To delete a paired BLUETOOTH device from the device list

1 Follow Steps 1 to 3 above.

2 Press / repeatedly to select the device, then press OPTIONS.

3 Press / repeatedly to select [Remove], then press .

4 Press / repeatedly to select [OK], then press .

Connecting to a remote device by One-touch listening function (NFC)

NFC (Near Field Communication) is a technology enabling short-range wireless communication between various devices.

By holding an NFC-compatible remote device near to the N-Mark on the unit, the system and remote device proceed to complete pairing and the BLUETOOTH connection automatically.

Compatible remote devices

Remote devices with a built-in NFC function
(OS: Android 2.3.3 or later, excluding Android 3.x)
This feature does not work with NFC-compatible receiver (such as headphones).

Note

- The system only can recognize and connect to one NFC-compatible device at a time.
- Depending on your remote device, you may need to perform the following items on your remote device in advance.

- Turn on the NFC function. For details, refer to the operating instructions of the remote device.
- If your remote device is having an older OS version than Android 4.1.x, download and start the “NFC Easy Connect” application. “NFC Easy Connect” is a free application for Android remote devices that can be obtained from Google Play. (The application may not be available in some countries/regions.)

- 1 Hold the remote device near to the N-Mark on the unit until the remote device vibrates.**

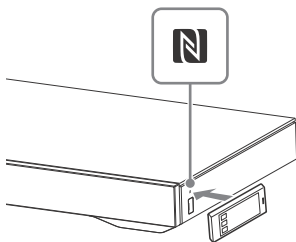

Follow the on-screen instructions displayed on the remote device, and complete the procedure for BLUETOOTH connection.

When the BLUETOOTH connection is established, the blue LED indicator on the front panel lights up.

- 2 Start playback of audio source on the remote device.**

For details on playback operations, refer to the operating instructions of your remote device.

Tip

- If pairing and the BLUETOOTH connection fail, do the following.
 - Hold the remote device near to the N-Mark on the unit again.
 - Remove the case from the remote device if using a commercially available remote device case.

- Relaunch “NFC Easy Connect” application.
- Set the [Quick Start/Network Standby] to [On] if you want to connect a BLUETOOTH device when the system is in standby mode.
- If the volume level is low, adjust the volume of the remote device first. If the volume level is still too low, adjust the volume level on the unit.
- If you hold the remote device near to the N-Mark when the system is in transmitter mode, the [Bluetooth Mode] is changed to [Receiver] automatically. This feature does not work with NFC-compatible receiver.

To stop playback

The playback will be stopped when you perform any of the following items.

- Hold the remote device near to the N-Mark on the unit again.
- Stop the music player of the remote device.
- Turn off the system or the remote device.
- Change the input.
- Disable the BLUETOOTH function on the remote device.
- Press **■**, HOME or PAIRING  on the remote control.

Listening to sound by transmitting to a BLUETOOTH-compatible receiver

You can listen to sound of the source playing via this system using BLUETOOTH-compatible receiver (such as headphones).

- 1 Turn on BLUETOOTH function on the BLUETOOTH receiver.**

2 Set [Bluetooth Mode] to [Transmitter] in [Bluetooth Settings] (page 24).

3 Press \leftarrow/\rightarrow to select [OK].

4 Press \uparrow/\downarrow to select the BLUETOOTH receiver's name from [Device List] in [Bluetooth Settings] (page 24), then press \oplus .

When the BLUETOOTH connection is established, the blue LED indicator lights up.

Note

If you cannot find your BLUETOOTH receiver's name in the list, select [Scan].

5 Return to the home screen and select the input you want.

"BT TX" appears in the front panel display, and the sound is output from the BLUETOOTH receiver. No sound is output from speakers of the system.

6 Adjust the volume.

Adjust the volume of the BLUETOOTH receiver. When connected to a BLUETOOTH receiver, volume level of the unit cannot be controlled. Volume touch keys on the unit and buttons on the remote control only works for the BLUETOOTH receiver.

Note

- You may not be able to adjust the volume level depending on the BLUETOOTH receiver.
- [Screen mirroring] input, [Bluetooth Audio] input and Home Theatre Control function are disabled when the system is in transmitter mode.
- When [Bluetooth Audio] or [Screen mirroring] input is selected, you cannot set [Bluetooth Mode] to [Transmitter].

You cannot switch it with RX/TX Ⓜ on the remote control neither.

- You can register up to 9 BLUETOOTH receivers. If the 10th BLUETOOTH receiver is registered, the least recently connected BLUETOOTH receiver will be replaced by the new one.

- The system can display up to 15 detected BLUETOOTH receivers in the [Device List].
- You cannot change the sound effects or settings in Options menu during sound transmitting.
- Some contents cannot be output due to content protection.
- The audio output from the BLUETOOTH receiver may be delayed from that on the system because of the characteristics of the BLUETOOTH wireless technology.
- No sound is output from system's speakers and HDMI OUT (ARC) jack when BLUETOOTH receiver is successfully connected to the system.

Tip

- Once the system and BLUETOOTH receiver are connected, you can control playback by using playback operation buttons on the BLUETOOTH receiver.
- You can connect this system to the most recently connected BLUETOOTH receiver by pressing RX/TX Ⓜ repeatedly to select [Transmitter]. Then, start playback the source on the system.

To disconnect the BLUETOOTH receiver

Perform any of the following items.

- Disable the BLUETOOTH function on BLUETOOTH receiver.
- Set [Bluetooth Mode] to [Receiver] or [Off] (page 24).
- Turn off the system or the BLUETOOTH receiver.
- Perform the One-touch function (NFC).

To delete a registered BLUETOOTH receiver

1 Select [Device List] in [Bluetooth Settings] (page 24).

A list of paired and detected BLUETOOTH receivers appears.

2 Press \uparrow/\downarrow to select the device, then press OPTIONS.

3 Press \uparrow/\downarrow to select [Remove], then press \oplus .

4 Press \leftarrow/\rightarrow to select [OK], then press \oplus .

Connecting with a wired network

Connecting the system to the network using a LAN cable

The following illustration is an example configuration of a home network with the system and a server.

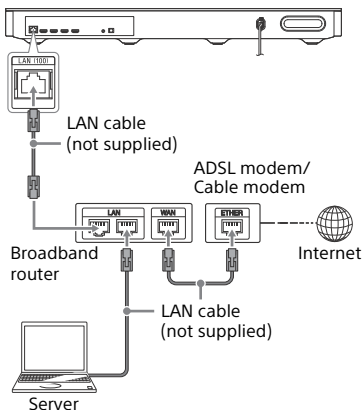

Tip

We recommend that you use a shielded and straight interface cable (LAN cable).

Setting up a wired LAN connection

You do not need to perform the following set up if you have performed the [Easy Network Settings].

- 1 **Press HOME.**
The home screen appears on the TV screen.
- 2 **Press \blacktriangle to select  [Setup] at the upper right corner, then press \oplus .**
- 3 **Press $\blacktriangle/\blacktriangledown$ to select [Network Settings], then press \oplus .**
- 4 **Press $\blacktriangle/\blacktriangledown$ to select [Internet Settings], then press \oplus .**
- 5 **Press $\blacktriangle/\blacktriangledown$ to select [Wired Setup], then press \oplus .**
The screen for selecting the IP address acquisition method appears on the TV screen.
- 6 **Press $\blacktriangle/\blacktriangledown$ to select [Auto], then press \oplus .**
- 7 **Press $\blacktriangle/\blacktriangledown$ to browse information, then press \blacktriangleright .**
- 8 **Press $\blacktriangle/\blacktriangledown$ to select [Save & Connect], then press \oplus .**
The system starts connecting to the network. For details, refer to the messages that appear on the TV screen.

If using a fixed IP address

Select [Custom] in step 6, then follow the on-screen instructions to select [Specify IP address]. The IP address input display appears on the TV screen. Follow the on-screen instructions to enter the value for [IP Address], then press \oplus to confirm the values. Enter the values for [Subnet Mask], [Default Gateway], [Primary DNS] and [Secondary DNS], then press \oplus .

Connecting with a wireless network

Setting up a wireless LAN connection

Before performing network settings

When your wireless LAN router (access point) is Wi-Fi Protected Setup (WPS)-compatible, you can easily set the network settings with the WPS button. If not, you will be required to select or enter the following information. Check the following information in advance.

- The network name (SSID)* of the wireless LAN router/access point
- The security key (password)** for the network

* SSID (Service Set Identifier) is a name that identifies a particular access point.

** This information should be available from a label on your wireless LAN router/access point, from the operating instructions, from the person who set up your wireless network, or from the information provided by your Internet service provider.

1 Follow Steps 1 to 4 of “Setting up a wired LAN connection” (page 15).

2 Press **↔/↔** to select [Wireless Setup(built-in)], then press **⊕**.

A list of available SSIDs (access points) appears on the TV screen.

3 Press **↔/↔** to select the network name (SSID) you want, then press **⊕**.

The security setting display appears on the TV screen.

4 Enter the security key (WEP key, WPA/WPA2 key) using the software keyboard. Use **↔/↔/↔/↔** and **⊕** to select the characters/numbers, then select [Enter] to confirm the security key.

The system starts connecting to the network. For details, refer to the messages that appear on the TV screen.

If using a fixed IP address

Select [New connection registration] in step 3, select [Manual registration], then follow the on-screen instructions to select [Specify IP address]. The IP address input display appears on the TV screen.

Follow the on-screen instructions to enter the value for [IP Address], then press **⊕** to confirm the values.

Enter the values for [Subnet Mask], [Default Gateway], [Primary DNS] and [Secondary DNS], then press **⊕**.

Note

The security setting display in step 4 does not appear if your network has not been secured by encryption (using the security key).

Playing files on a Home Network

You can play music/photo files on other Home Network-compatible device by connecting them to your home network.

This system can be used as a player and renderer.



- Server: Stores and shares digital media contents
- Player: Finds and plays digital media content from the server

- **Renderer:** Receives and plays files from the server, and can be operated by another device (controller)
- **Controller:** Operates the renderer device

Prepare for using the Home Network function.

- Connect the system to a network (page 15).
- Prepare other Home Network-compatible device. For details, refer to the operating instructions of the device.

To play files stored on a server via the system (Player)

Select [Home Network] from the home screen, then select the server. Select the file you want to play from  [Music] or  [Photo].

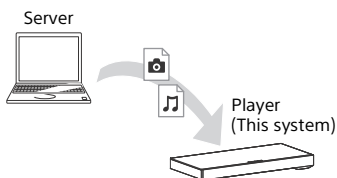

To play remote files by operating the system (Renderer) via a Home Network Controller

You can operate the system with a Home Network Controller-compatible device (a mobile phone, etc.), when playing files stored on a server.

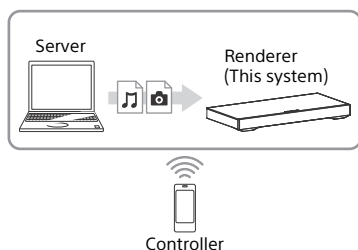

For details on operation, refer to the operating instructions of the Home Network Controller-compatible device.

Note

Do not operate the system with the supplied remote control and a controller at the same time.

Tip

The system is compatible with the "Play To" function of Windows Media® Player 12 that comes standard with Windows 7.

Enjoying various online services

You can listen to music services offered on the Internet with this system. To use this function, the system must be connected to the Internet. The operation below will display a guide to invite you to music services. Follow the guide to enjoy the music services.

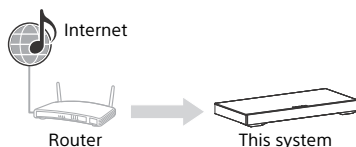

1 Press HOME.

The home screen appears on the TV screen.

2 Press / to select [Music Services], then press .

The service provider list appears on the TV screen.

Note

Depending on the Internet content connection status, the service provider list may take some time to appear on the TV screen.

Tip

You can update the service provider list by pressing **OPTIONS**, then select [Update List].

- Press **↔** to select the music service you want, then press **+**. Press **BACK** to go to the previous directory.

Using Google Cast™

Google Cast allows you to select music content from the Google Cast™-enabled app and play back on the system.

Google Cast requires the initial setup using SongPal.

- Download free SongPal app to the mobile device such as smartphone.
- Connect the device by Wi-Fi to the same network as that of the system (page 15).
- Start SongPal, select "HT-XT3", and tap "Settings" - "Google Cast" - "Learn how to Cast".
- Check the operation and Google Cast-enabled app, and download the app.

- Start the Google Cast-enabled app, tap the cast button, and select "HT-XT3".



- Select and play music on the Google Cast-enabled app. The music is played on the system.

Note

You cannot use Google Cast while "GOOGLE CAST UPDATING" appears in the front panel display. Wait until the update is complete, and then try again.

Using Screen mirroring

"Screen mirroring" is a function to display the screen of a mobile device on the TV by Miracast technology. The system can be connected directly with a Screen mirroring-compatible device (e.g. smartphone, tablet). You can enjoy the display screen of the device on your large TV screen. No wireless router (or access point) is required to use this feature.

- Press **MIRRORING**.
- Follow the on-screen instructions. Activate the Screen mirroring function from your device. For details on how to activate the function, refer to the operating instructions supplied with your device.

To connect to an Xperia smartphone using One-touch mirroring function (NFC)

Press MIRRORING, then hold the Xperia smartphone near to the N-Mark on the unit.

To exit mirroring

Press HOME or INPUT +/-.

Note

- When using Screen mirroring, the quality of picture and sound may sometimes be deteriorated due to interference from other network.
- Some network functions may not be available during Screen mirroring.
- Make sure that the device is compatible with Miracast. Connectivity with all Miracast compatible devices is not guaranteed.
- Depending on the usage environment, the quality of the picture and sound may deteriorate.

Tip

- You can select your preference sound effect during mirroring. Press the sound effect buttons (page 45).
- If the quality of the picture and sound often deteriorates, you may improve the quality by setting the [Screen mirroring RF Setting] (page 27).

Viewing Copyright-protected 4K Content

Connecting a 4K TV

To view copyright-protected 4K content, connect the system and TV via an HDCP 2.2-compatible HDMI jack. For details on whether the TV is equipped with HDCP 2.2-compatible HDMI jack, refer to the operating instructions supplied with the TV.

When the TV's HDMI jack is labeled with ARC* and compatible with HDCP 2.2

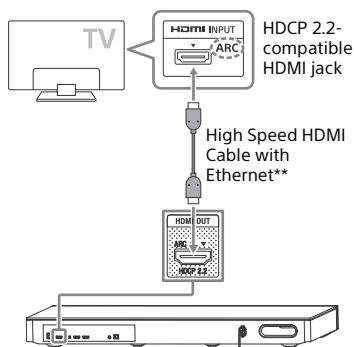

- * The ARC (Audio Return Channel) function sends digital sound from a TV to this system using just an HDMI cable.
- ** Supplied only for certain areas.

When the TV's HDMI jack is labeled with ARC and not compatible with HDCP 2.2

If your TV's HDMI jack is labeled with ARC and not compatible with HDCP 2.2, connect the system to your TV's HDMI jack that is compatible with HDCP 2.2 using an HDMI cable. Then, connect an optical digital cable to the optical output jack of the TV to listen to digital sound.

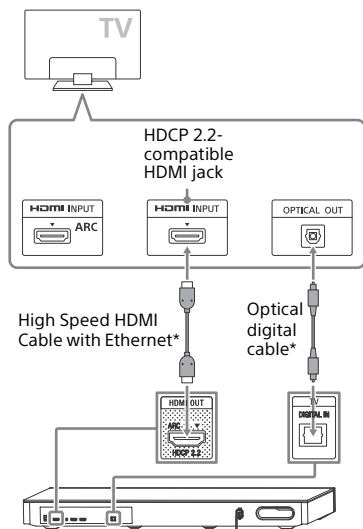

* Either High Speed HDMI cable or optical digital cable is supplied depending on area.

Connecting 4K devices

Connect a 4K device to the HDMI IN 1 jack of the system. For details on whether the device is HDCP 2.2-compatible, refer to the operating instructions supplied with the device.

Blu-ray Disc™ player, cable box or satellite box, etc.

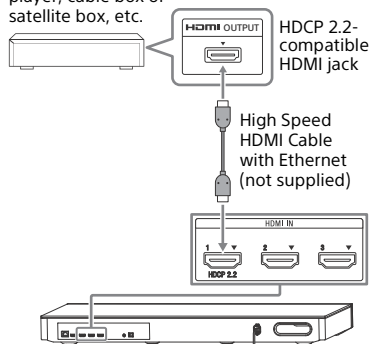











Settings and Adjustments

Using the Setup Display

You can make various adjustments to items such as picture and sound. The default settings are underlined.

- 1 Press HOME.**
The home screen appears on the TV screen.
- 2 Press \blacktriangle to select  [Setup] at the upper right corner, then press \oplus .**
- 3 Press $\blacktriangle/\blacktriangledown$ to select the setup category icon, then press \oplus .**

Icon	Explanation
	[Software Update] (page 21) Updates the software of the system.
	[Screen Settings] (page 22) Makes the screen settings according to the type of TV.
	[Audio Settings] (page 23) Makes the audio settings according to the type of connecting jacks.
	[Bluetooth Settings] (page 24) Makes detailed settings for the BLUETOOTH function.
	[System Settings] (page 25) Makes the system-related settings.
	[Network Settings] (page 27) Makes detailed settings for Internet and network.
	[Input Skip Setting] (page 27) Sets the input skip setting for each input.
	[Easy Setup] (page 28) Re-runs the [Easy Setup] to make the basic settings.

Icon	Explanation
	[Easy Network Settings] (page 28) Runs [Easy Network Settings] to make the basic network settings.
	[Resetting] (page 28) Resets the system to the factory settings.

[Software Update]

By updating your software to the latest version, you can take advantage of the newest functions.

During a software update, "UPDT" appears in the front panel display. After the update completes, the system automatically reboots.

While the updating operation is in progress, do not turn on or off the system, or operate the system or TV. Wait for the software update to complete.

Note

- For information about update functions, visit the following website:

For customers in Europe and Russia:
www.sony.eu/support

For customers in other countries/regions:
<http://www.sony-asia.com/section/support>

- If your network condition is poor, visit the website above to download the latest software version and update via USB memory.
- Set [Auto Update] to [On] when you want to perform software updates automatically (page 26). Depending on the contents of the updates, software update may be performed even if you set [Auto Update] to [Off].

■ [Update via Internet]

Updates the system's software using available network. Make sure network is connected to the Internet. For details, see "Network Function" (page 15).

■ [Update via USB Memory]

Updates software using USB memory. Make sure that the Software Update Folder is correctly named as "UPDATE". The system can recognize up to 500 files/folders in a single layer including the update files/folders.



Screen Settings

■ [TV Type]

[16:9]: Select this when connecting to a wide-screen TV or a TV with a wide-mode function.

[4:3]: Select this when connecting to a 4:3 screen TV without a wide-mode function.

■ [Output Video Resolution]

[Auto]: Outputs video signal according to the resolution of the TV or connected device.

[480i/576i]*, [480p/576p]*, [720p], [1080i], [1080p]: Outputs video signal according to the selected resolution setting.

* If the color system of the playback content is NTSC, the video signals resolution can be converted to [480i] and [480p] only.

■ [24p Output]

[Network content 24p Output]
This function sets the signals output from the HDMI OUT (ARC) jack on the system when using the Screen mirroring function.

[Auto]: Outputs 24p video signals only when you connect a 1080/24p-compatible TV via an HDMI connection and the [Output Video Resolution] is set to [Auto] or [1080p].

[Off]: Select this when your TV is not compatible with 1080/24p video signals.

■ [4K Output]

[Auto1]: Outputs 2K (1920 × 1080) video signals during video playback (Screen mirroring) and 4K video signals during photo play when connecting to a Sony 4K-compatible device.

Outputs 4K video signals during 24p video contents playback or photo play when connecting to a non-Sony 4K-compatible device.

[Auto2]: Automatically outputs 4K/24p video signals when you connect a 4K/24p-compatible device and make the appropriate setting for [Network content 24p Output] in [24p Output], and also outputs 4K/24p photo images when you play 2D photo files.

[Off]: Turns off the function.

Note

If your Sony device is not detected when [Auto1] is selected, the setting will have the same effect as [Auto2] setting.

■ [YCbCr/RGB (HDMI)]

[Auto]: Automatically detects the type of external device, and switches to the matching color setting.

[YCbCr (4:2:2)]: Outputs YCbCr 4:2:2 video signals.

[YCbCr (4:4:4)]: Outputs YCbCr 4:4:4 video signals.

[RGB]: Select this when connecting to a device with an HDCP compliant DVI jack.

■ [HDMI Deep Colour Output]

[Auto]: Normally select this.
 [12bit], [10bit]: Outputs 12bit/10bit video signals when the connected TV is compatible with Deep Colour.
 [Off]: Select this when the picture is unstable or colors appear unnatural.

■ [Video Direct]

You can disable the On-Screen Display (OSD) of the system when [HDMI1], [HDMI2] or [HDMI3] input is selected. This function is useful when playing a game, you can fully enjoy the game's screen.

[On]: Disables the OSD. Information will not be displayed on the screen and the OPTIONS and DISPLAY buttons are disabled.

[Off]: Displays information on the screen when you change the settings such as selecting the sound field.

■ [SBM] (Super Bit Mapping)

[On]: Smooths the gradation of video signals output from the HDMI OUT (ARC) jack.

[Off]: Select this when outputting distorted video signals or unnatural color.

**[Audio Settings]****■ [DSEE HX]**

This function only works when [Music] is selected as sound field.

[On]: Upscales the audio file to a High-Resolution Audio file and reproduces the clear high-range sound which is often lost (page 10).

[Off]: Off.

■ [Audio DRC]

You can compress the dynamic range of the sound track.

[Auto]: Automatically compresses sound encoded in Dolby TrueHD.

[On]: The system reproduces the sound track with the kind of dynamic range that the recording engineer intended.

[Off]: No compression of dynamic range.

■ [Attenuation settings - Analog]

Distortion may occur when you listen to a device connected to the ANALOG IN jack. You can prevent distortion by attenuating the input level on the system.

[On]: Attenuates the input level. The output level will decrease at this setting.

[Off]: Normal input level. Select this when connecting to a portable device (such as digital media player).

■ [Audio Output]

You can select the output method where the audio signal is output.

[Speaker]: Outputs sound from the system's speakers only.

[Speaker + HDMI]: Outputs sound from the system's speakers and 2-channel linear PCM signals from the HDMI OUT (ARC) jack.

[HDMI]: Outputs sound from the HDMI OUT (ARC) jack only. Sound format depends on the connected device.

Note

- When [Control for HDMI] is set to [On] (page 25), [Audio Output] is set to [Speaker + HDMI] automatically and this setting cannot be changed.
- Audio signals are not output from the HDMI OUT (ARC) jack when [Audio Output] is set to [Speaker + HDMI] and [HDMI1 Audio Input Mode] (page 26) is set to [TV]. (Europe models only)



[Bluetooth Settings]

■ [Bluetooth Mode]

You can enjoy contents from remote device by using this system or listen to sound from this system by using other device such as headphones.

[Receiver]: This system is in receiver mode which enables it to receive and output audio from the remote device.

[Transmitter]: This system is in transmitter mode which enables it to send audio to the BLUETOOTH receiver (such as headphones). If you switch the input of the system, "BT TX" appears in the front panel display.

[Off]: The BLUETOOTH power is turned off and you cannot select the [Bluetooth Audio] input.

Note

You can connect to a remote device by using One-touch listening function even though you have set [Bluetooth Mode] to [Off].

■ [Device List]

Display a list of paired and detected BLUETOOTH receivers when [Bluetooth Mode] is set to [Transmitter] (page 24).

■ [Bluetooth Standby]

You can set the [Bluetooth Standby] so that the system can be turned on by a BLUETOOTH device even when the system is in standby mode. This function is only available when you set [Bluetooth Mode] to [Receiver] or [Transmitter].

[On]: The system turns on automatically when you establish a BLUETOOTH connection from a paired BLUETOOTH device.

[Off]: Off.

Note

If you set [Quick Start/Network Standby] to [Off] and [Bluetooth Standby] to [On], the system can be turned on by a BLUETOOTH device, but BLUETOOTH connection fails.

■ [Bluetooth Codec - AAC]

This function is only available when you set [Bluetooth Mode] to [Receiver] or [Transmitter].

[On]: Enable AAC codec.

[Off]: Disable AAC codec.

Note

- You can enjoy high quality sound if the AAC is enabled. In case you cannot listen to AAC sound from your device, select [Off].
- If you change the [Bluetooth Codec - AAC] setting when a BLUETOOTH device is connected, the codec setting is only reflected after the next connection.

■ [Bluetooth Codec - LDAC]

This function is only available when you set [Bluetooth Mode] to [Receiver] or [Transmitter].

[On]: Enable LDAC codec.

[Off]: Disable LDAC codec.

Note

If you change the [Bluetooth Codec - LDAC] setting when a BLUETOOTH device is connected, the codec setting is only reflected after the next connection.

Tip

LDAC is an audio coding technology developed by Sony that enables the transmission of High-Resolution (Hi-Res) Audio content, even over a BLUETOOTH connection. Unlike other BLUETOOTH compatible coding technologies such as SBC, it operates without any down-conversion of the Hi-Res Audio content*, and allows approximately three times more data** than those other technologies to be transmitted over a BLUETOOTH wireless network with unprecedented sound quality, by means of efficient coding and optimized packetization.

- * Excluding DSD format contents.
- ** In comparison with SBC (Subband Coding) when the bitrate of 990 kbps (96/48 kHz) or 909 kbps (88.2/44.1 kHz) is selected.

■ [Wireless Playback Quality]

You can set transmission data rate of LDAC playback. This function is only available when you set [Bluetooth Mode] to [Transmitter] and [Bluetooth Codec - LDAC] to [On].

[Auto]: The data rate is automatically changed depending on environment. If audio playback is unstable in this setting, use other three settings.

[Sound Quality]: The highest data rate is used. Sound is sent in the higher quality, however audio playback sometimes may become unstable when the link quality is not good enough.

[Standard]: The middle data rate is used. It balances both sound quality and playback stability.

[Connection]: Stability is prioritized. Sound quality may be reasonable and connection status will most likely be stable. If the connection is unstable, this setting is recommended.

**[System Settings]****■ [OSD Language]**

You can select the language you want for the system on-screen display.

■ [HDMI Settings]

[Control for HDMI]

[On]: Turns on the [Control for HDMI] function. You can operate mutually between device that are connected with an HDMI cable.

[Off]: Off.

[Audio Return Channel]

This function is available when you connect the system to a TV's HDMI IN jack that is compatible with the Audio Return Channel function and [Control for HDMI] is set to [On].

[Auto]: The system can receive the digital audio signal of the TV automatically via an HDMI cable.

[Off]: Off.

[Standby Through]

You can output HDMI signals to the TV even when the system is in standby mode. This function is available when you set [Control for HDMI] to [On].

Default setting:

- [Off] (Europe models only)
- [Auto] (Other models)

[Auto]: Outputs signals from the HDMI OUT (ARC) jack when the TV is turned on while the system is in the standby mode. This setting saves power in the standby mode compared to the [On] setting.

[On]: Always output signals from the HDMI OUT (ARC) jack when the system is in standby mode. If you connect a TV other than "BRAVIA", we recommend you to select this setting.

[Off]: No signals are output when system is in standby mode. This setting saves power in the standby mode compared to the [On] setting.

[HDMI1 Audio Input Mode] (Europe models only)

You can select the audio input of the device that is connected to the HDMI IN 1 jack.

[HDMI1]: The sound of the device that is connected to the HDMI IN 1 jack is input from the HDMI IN 1 jack.

[TV]: The sound of the device that is connected to the HDMI IN 1 jack is input from the TV (DIGITAL IN) jack.

■ [Quick Start/Network Standby]

[On]: Shortens the startup time from standby mode. You can operate the system quickly after turning it on.

[Off]: The default setting.

■ [Auto Standby]

[On]: Turns on the [Auto Standby] function. When you do not operate the system for about 20 minutes, the system enters standby mode automatically.

[Off]: Off.

■ [Auto Display]

[On]: Automatically displays information on the screen when changing the audio signals, picture mode, etc.

[Off]: Displays information only when you press DISPLAY.

■ [Software Update Notification]

[On]: Sets the system to inform you of latest software version information (page 21).

[Off]: Off.

■ [Auto Update Settings]

[Auto Update]

[On]: Software update is automatically executed between 2 a.m. and 5 a.m. local time in the selected [Time Zone] while this system is not in use. If you set [Quick Start/Network Standby] to [Off], software update is performed after you turned off the system.

[Off]: Off.

[Time Zone]

Select your country/region.

Note

- Depending on the contents of the updates, software update may be performed even if you set [Auto Update] to [Off].
- Software update is performed automatically within 11 days of a new software release.

■ [Device Name]

You can change the name of this system according to your preference so that it is more recognizable during BLUETOOTH or Screen mirroring function. The name is also used in other network usage such as Home Network. Follow on-screen instructions and use software keyboard to enter the name.

■ [System Information]

You can display the system's software version information and the MAC address.

■ [Software License Information]

You can display the Software License Information.



[Network Settings]

■ [Internet Settings]

Connect the system to the network beforehand. For details, see “Network Function” (page 15).

[Wired Setup]: Select this when you connect to a broadband router using a LAN cable. When you select this setting, the built-in wireless LAN is disabled automatically.

[Wireless Setup(built-in)]: Select this when you use the built-in wireless LAN of the system for wireless network connection.

Tip

For further details, visit the following website and check the FAQ:

For customers in Europe and Russia:
www.sony.eu/support

For customers in other countries/regions:
<http://www.sony-asia.com/section/support>

■ [Network Connection Status]

Displays the current network connection status.

■ [Network Connection Diagnostics]

You can run the network diagnostic to check if the network connection has been made properly.

■ [Screen mirroring RF Setting]

If you use multiple wireless systems, such as a wireless LAN (Local Area Network), the wireless signals may be unstable. In this case, playback stability may be improved by setting the priority radio frequency channel for Screen mirroring.

[Auto]: Normally select this. The system automatically selects the better channel for Screen mirroring.

[CH 1]/[CH 6]/[CH 11]: The selected channel is prioritized for Screen mirroring connection.

■ [Connection Server Settings]

Sets whether or not to display the connected Home Network server.

■ [Auto Renderer Access Permission]

[On]: Allows automatic access from a newly detected Home Network controller.

[Off]: Off.

■ [Renderer Access Control]

Displays a list of Home Network controller-compatible products and sets whether or not to accept commands from the controllers in the list.

■ [External Control]

[On]: Allows the home automation controller to operate this system.

[Off]: Off.

■ [Remote Start]

[On]: Allows turn on the system by a device linked via network when the system is in standby mode.

[Off]: The system cannot be turned on by a device linked via network.



[Input Skip Setting]

The skip setting is a convenient feature that allows you to skip unused inputs when selecting an input by pressing INPUT +/-.

[Do not skip]: The system does not skip the selected input.

[Skip]: The system skips the selected input.

Note

If you press INPUT +/- when the home screen is displayed, input icon appears dimmed if it has been set to [Skip].



[Easy Setup]

Runs [Easy Setup] to make the basic initial settings and basic network settings for the system. Follow the on-screen instructions.



[Easy Network Settings]

Runs [Easy Network Settings] to make the basic network settings. Follow the on-screen instructions.



[Resetting]

■ [Reset to Factory Default Settings]

You can reset the system settings to the factory default by selecting the group of settings. All the settings within the group will be reset.

■ [Initialise Personal Information]

You can erase your personal information stored in the system.

Note

If you dispose, transfer or resell this system, please delete all Personal Information for security purposes. Please take the appropriate measures such as logging out after using a network service.

Using the Options menu

Various settings and playback operations are available by pressing OPTIONS. The available items differ depending on the situation.

Common options

[A/V SYNC]

Adjusts the time gap between picture and sound (page 29).

[Sound Field]

Changes the sound field setting (page 9).

[Night]

Turns on or off the Night mode function (page 10).

[Voice]

Enhances the dialogue range to enjoy clear voice sounds (page 10).

[Repeat Setting]

Sets repeat playback.

[Play/Stop]

Starts or stops playback.

[Play from start]

Plays the item from the beginning.

[Change Category]

Switches between the 🎵 [Music] and 📷 [Photo] category in [USB] or [Home Network] input. This item only available when the display list is available for the category.

🎵 [Music] only

[Shuffle Setting]

Sets shuffle playback.

[Add Slideshow BGM]

Registers music files in the USB memory as slideshow background music (BGM).

📷 [Photo] only**[Slideshow]**

Starts a slideshow.

[Slideshow Speed]

Changes the slideshow speed.

[Slideshow Effect]

Sets the effect when playing a slideshow.

[Slideshow BGM]

- [Off]: Turns off the function.
- [My Music from USB]: Sets the music files registered in [Add Slideshow BGM].

[Change Display]

Switches between [Grid View] and [List View].

[Rotate Left]

Rotates the photo counterclockwise by 90 degrees.

[Rotate Right]

Rotates the photo clockwise by 90 degrees.

[View Image]

Displays the selected picture.

Adjusting the delay between the picture and sound

[A/V SYNC]

When the sound does not match the pictures on the TV screen, you can adjust the delay between the picture and sound for the following inputs. The setting method differs depending on the input.

When the [HDMI1], [HDMI2], or [HDMI3] input is selected

- 1 Press OPTIONS.**
The Options menu appears on the TV screen.
- 2 Press \leftarrow/\rightarrow to select [A/V SYNC], then press \oplus .**
- 3 Press \leftarrow/\rightarrow to adjust the delay, then press \oplus .**
You can adjust from 0 ms to 300 ms in 25 ms increments.

When the [TV] input is selected

- 1 Press OPTIONS.**
"SYNC" appears in the front panel display.
- 2 Press \oplus or \rightarrow .**
- 3 Press \leftarrow/\rightarrow to adjust the delay, then press \oplus .**
You can adjust from 0 ms to 300 ms in 25 ms increments.
- 4 Press OPTIONS.**
"SYNC" disappears from the front panel display.



Controlling the system using a smartphone or tablet (SongPal)

SongPal is a dedicated app for operating SongPal-compatible audio devices manufactured by Sony using a smartphone or tablet. Search for SongPal on Google Play™ or App Store and download it using your smartphone or tablet.

SongPal allows you to:

- change commonly used settings, selecting the input of the system and adjusting the volume.
- enjoy music content stored on a home network server or smartphone with the system.
- enjoy music visually with your smartphone display.
- configure Wi-Fi connection settings easily using SongPal if your Wi-Fi router does not have a WPS function.
- use the SongPal Link function (page 30).

Note

- Before you start to perform the operations below, be sure to set the [Bluetooth Mode] to [Receiver] (page 24).
- This system is compatible with SongPal version 3.0 or later.
- SongPal uses the network function (page 15) and/or BLUETOOTH function (page 11) of the system.
- Specifications and display design of SongPal are subject to change without notice.

When using an Android device

- 1 Search, download and launch SongPal application on Android device.
- 2 Connect the system and Android device by BLUETOOTH connection (page 11) or network connection (page 15).

Tip

If you connect the system and Android device by network connection, connect the device by Wi-Fi to the same network as that of the system.

- 3 Follow the instructions on SongPal.

When using an iPhone/iPod

- 1 Search, download and launch SongPal application on iPhone/iPod.
- 2 Connect the system and iPhone/iPod by BLUETOOTH connection (page 11) or network connection (page 15).

Tip

If you connect the system and iPhone/iPod by network connection, connect the iPhone/iPod by Wi-Fi to the same network as that of the system.

- 3 Follow the instructions on SongPal.

Listening to the same music on multiple devices/ listening to different music in a different location (SongPal Link)

You can enjoy music stored on your computer or smartphone or from music services in multiple rooms at the same time.

For details on SongPal Link, please visit the following URL:

<http://www.sony.net/nasite>

Using the Control for HDMI Function for "BRAVIA" Sync

This function is available on TVs with the "BRAVIA" Sync function.

By connecting Sony products that are compatible with the Control for HDMI function via an HDMI cable, operation is simplified with the features below.

You can enable the Control for HDMI function by setting [Control for HDMI] to [On] (page 25).

Note

- To use the "BRAVIA" Sync function, be sure to turn on the system and all connected device after completed the HDMI connection.
- Depending on the settings of the connected device, the Control for HDMI function may not work correctly. Refer to the operating instructions of the device.

Control for HDMI - Easy Setting

You can set the system's [Control for HDMI] function automatically by enabling the corresponding setting on the TV.

"DONE" appears in the front panel display when the Easy Setting is completed.

Note

You can set [Control for HDMI] function manually if the above setting is not working. For details, see "[HDMI Settings]" (page 25).

System Power Off

When you turn off the TV, the system and the connected device will turn off automatically.

Note

- The system does not turn off automatically while playing music on this system.
- The System Power Off function may work with devices other than those manufactured by Sony, but operation is not guaranteed.

One-Touch Play

When you play content on a device (Blu-ray Disc™ player, "PlayStation®4", etc.) connected to the system with an HDMI cable, the system and TV are turned on automatically and the input of the system is switched to the appropriate HDMI input.

Note

- The feature above may not operate with certain devices.
- If you set [Standby Through] to [Auto] or [On] (page 25), then play back the contents on a connected device when the system is in standby mode, sound and image can only be output from the TV while the system remains in standby mode.
- The One-Touch Play function may work with devices other than those manufactured by Sony, but operation is not guaranteed.

System Audio Control

If you turn on the system while you are watching the TV, the TV sound will be output from the speakers of the system automatically.

The volume of the system will be adjusted when you adjust the volume using the TV's remote control.

If the TV sound was output from the speakers of the system the last time you watched the TV, the system will be turned on automatically when you turn on the TV again.

You can also enjoy this feature when using Twin Picture function (Picture and Picture (P&P)) on your TV.

- If the [TV], [HDMI1], [HDMI2] or [HDMI3] input is selected, the sound can be output from the system.
- If other than [TV], [HDMI1], [HDMI2] or [HDMI3] input is selected, the sound is output only from the TV when using the Twin Picture function. When you turn off the Twin Picture function, the sound is output from the system.

Note

- The number for the system's volume level is displayed on the TV screen depending on the TV. The displayed volume number may differ from the number on the front panel display of the unit.
- The System Audio Control function may work with devices other than those manufactured by Sony, but operation is not guaranteed.

Audio Return Channel

You can enjoy TV sound via the system by using just one HDMI cable. For details of the setting, see "[Audio Return Channel]" (page 25).

Note

The Audio Return Channel function may work with devices other than those manufactured by Sony, but operation is not guaranteed.

Echo Canceling Sync

You can reduce the echo when you use the Social Viewing function while watching TV programs. Conversation becomes clearer.

- If the current selected input is [TV], [HDMI1], [HDMI2] or [HDMI3], the input is automatically changed to [TV] input. Sound of the Social Viewing and TV program is output from the system.

- If the current selected input is other than [TV], [HDMI1], [HDMI2] or [HDMI3], the sound of the Social Viewing and the playback content is output from TV.

Note

- This feature only works for TV that supports Social Viewing function. For details, refer to the operating instructions of your TV.
- Be sure to set the audio output setting on your TV so that the sound can be output through this system.
- The Echo Canceling Sync function is a Sony proprietary function. This function cannot operate with non-Sony devices.

Home Theatre Control

If a Home Theatre Control-compatible TV is connected to the system, an icon for Internet based applications appears on the connected TV.

You can change the settings of the system (such as change an input or sound field) by using the remote control of your TV.

Note

- Your TV must be connected to Internet to use the Home Theatre Control function.
- The Home Theatre Control function is a Sony proprietary function. This function cannot operate with non-Sony devices.

Language Follow

When you change the language for the on-screen display of the TV, the system's on-screen display language is also changed.

Notes on HDMI connections

- Use a High Speed HDMI Cable with Ethernet. If you use a Standard HDMI cable, 1080p, Deep Colour, 3D, and 4K content may not be displayed properly.
- Use an HDMI-authorized cable. Use a Sony High Speed HDMI Cable with Ethernet with the Cable Type Logo.
- We do not recommend using an HDMI-DVI conversion cable.
- Audio signals (sampling frequency, bit length, etc.) transmitted from an HDMI jack may be suppressed by the connected device.
- Sound may be interrupted when the sampling frequency or the number of channels of audio output signals from the playback device is switched.
- When [TV] input is selected, video signals via one of the HDMI IN 1/2/3 jacks selected last time are output from the HDMI OUT (ARC) jack.
- This system supports Deep Colour, "x.v.Colour", 3D, and 4K transmission.
- To enjoy 3D content, connect a 3D-compatible TV and video device (Blu-ray Disc™ player, "PlayStation®4", etc.) to the system using High Speed HDMI Cable with Ethernet, put on 3D glasses, and then play back a 3D-compatible Blu-ray Disc™, etc.
- To enjoy 4K content, the TV and players that are connected to the system must be compatible with 4K content.

Enjoying multiplex broadcast sound (Dual Mono)

You can enjoy multiplex broadcast sound when the system receives a Dolby Digital multiplex broadcast signal.

Note

To receive a Dolby Digital signal, you need to connect a TV or other devices to the TV (DIGITAL IN) jack with an optical digital cable.

If your TV's HDMI IN jack is compatible with the Audio Return Channel function (page 25), you can receive a Dolby Digital signal via an HDMI cable.

Press **AUDIO** repeatedly until the signal you want appears in the front panel display.

- "MAIN": Sound of the main language will be output.
- "SUB": Sound of the sub language will be output.
- "MN/SB": Mixed sound of both the main and sub languages will be output.

Deactivating the touch keys on the unit (Child Lock)

You can deactivate the touch keys on the unit (except for I/⏻) for preventing misoperation, such as child mischief. Be sure to use the touch keys on the unit to perform this operation.

While holding **INPUT**, touch **VOL -**, **VOL +** and **VOL -** in sequence.

"LOCK" appears in the front panel display.

You can only operate the system by using the remote control.

To cancel, while holding **INPUT**, touch **VOL -**, **VOL +** and **VOL -** in sequence.

"UNLCK" appears in the front panel display.

Changing the brightness

You can change the brightness of the front panel display and blue LED indicator.

Press DIMMER repeatedly.

You can select "OFF", "DIM1" or "DIM2".*

* The brightness for "DIM1" and "DIM2" settings are the same.

Note

The front panel display is turned off when "DIM2" is selected. It turns on automatically when you press any buttons/touch keys, then turns off again if you do not operate the system for about 10 seconds. However, in some cases, the front panel display may not turn off.

Saving power in Standby Mode

Check that you have made the following settings:

- [Bluetooth Standby] is set to [Off] (page 24).
- [Control for HDMI] in [HDMI Settings] is set to [Off] (page 25).
- [Quick Start/Network Standby] is set to [Off] (page 26).
- [Remote Start] is set to [Off] (page 27).

Additional Information

Precautions

On safety

- Should any solid object or liquid fall into the cabinet, unplug the system and have it checked by qualified personnel before operating it any further.
- Do not touch the AC power cord (mains lead) with wet hands. Doing so may cause an electric shock.
- Do not climb on the system, as you may fall down and injure yourself, or system damage may result.
- Do not place anything other than a TV on the system.

On power sources

- Before operating the system, check that the operating voltage is identical to your local power supply. The operating voltage is indicated on the nameplate at the rear of the system.
- If you are not going to use the system for a long time, be sure to disconnect the system from the wall outlet. To disconnect the AC power cord (mains lead), grasp the plug itself; never pull the cord.
- AC power cord (mains lead) must be changed only at a qualified service shop.

On heat buildup

Although the system heats up during operation, this is not a malfunction. If you continuously use this system at a large volume, the cabinet temperature of the top, side and bottom rises considerably. To avoid burning yourself, do not touch the cabinet.

On placement

- Leave the front of the system open.
- Do not place the system on top of a device that radiates heat.
- Place the system in a location with adequate ventilation to prevent heat build-up in the system.
- Do not place the system on a soft surface (rugs, blankets, etc.) or place anything at the rear of the system that might block the ventilation holes and cause malfunctions.
- Do not install the system near heat sources such as radiators, air ducts, or in a place subject to direct sunlight, excessive dust, mechanical vibration, or shock.
- Do not install the system in an inclined position. It is designed to be operated in a horizontal position only.
- Do not place metal objects in front of the front panel. It may limit reception of radio waves.
- Do not place the system in a place where medical equipment is in use. It may cause a malfunction of medical equipment.
- If you use a pacemaker or other medical device, consult your physician or the manufacturer of your medical device before using the wireless LAN function.
- Use caution when placing the system on a surface that has been specially treated (with wax, oil, polish, etc.), as staining or discoloration of the surface may result.
- Take care to avoid any possible injury from the corners of the system.
- Install the system so as not to harm the speaker on the bottom of this system.
- The speakers of this system are not magnetically shielded.
Do not place magnetic cards or a CRT-type TV set on top of the system or near it.

Notes on the glass

- Do not set something hot on the top such as a heated pan or pot. The glass top may be broken, cause injury, or be a cause of damage to this system.
- Do not impart a strong impact to the glass top. The glass top of this system is made of hardened glass; however, there is no guarantee it cannot be shattered. Heed the following so as not to break the glass:
 - Do not impart a strong impact to the glass top by hitting it or by dropping something pointed.
 - Do not scratch the glass with something pointed or poke it.
 - Do not hit the side of the glass when installing in a storage rack.
- If the glass is broken, do not touch it with bare hands. It may cause cuts.
- Do not place anything on this system that weighs over 50 kg. Such an item can damage the glass top or this system.
- A tempered glass is stouter than ordinary glass but will shatter if broken.
- A tempered glass can shatter spontaneously in extremely rare instances.
The glass used in this system has been carefully selected: however, there is no guarantee it cannot be shattered.
- Be careful to keep the system level, when installing or moving it. Tilting it may result in damaging the system, or injury due to falling of the glass top.

On operation

Before connecting other devices, be sure to turn off and unplug the system.

On adjusting volume

Do not turn up the volume while listening to a section with very low level inputs or no audio signals. If you do, the speakers may be damaged when a peak level section is suddenly played.

On cleaning

Clean the cabinet, panel, and controls with a soft cloth slightly moistened with a mild detergent solution. Do not use any type of abrasive pad, scouring powder or solvent such as alcohol or benzene.

On replacement of parts

In the events that this system is repaired, repaired parts may be retained for reuse or recycling purposes.

IMPORTANT NOTICE

Caution: This system is capable of holding a still video image or on-screen display image on your TV screen indefinitely. If you leave the still video image or on-screen display image displayed on your TV for an extended period of time, you risk permanent damage to your TV screen. Plasma display panel televisions and projection televisions are susceptible to this.

Notes on updating

This system allows you to update the software automatically when connected to the Internet via a wired or wireless network.

You can add new features and use the system with more convenience and safety by updating the system.

If you do not want to update automatically, you can disable the function by using SongPal installed on your smartphone or tablet. However, the system may update the software automatically for reasons such as safety, even if this function is disabled. You can also update the software using the settings menu when this function is

disabled. See "Using the Setup Display" (page 21) for details.

You may not use the system while the software is being updated.

Disclaimer regarding services offered by third parties

Services offered by third parties may be changed, suspended, or terminated without prior notice. Sony shall not be held responsible in these situations.

If you have any questions or problems concerning your system, please consult your nearest Sony dealer.

Troubleshooting

If you experience any of the following difficulties while using the system, use this troubleshooting guide to help remedy the problem before requesting repairs. Should any problem persist, consult your nearest Sony dealer.

General

The power does not turn on.

→ Check that the AC power cord (mains lead) is connected securely.

The remote control does not function.

- The distance between the remote control and the unit is too far.
- The batteries in the remote control are weak.

The system is turned off automatically.

→ The [Auto Standby] is working. Set [Auto Standby] to [Off] (page 26).

The system does not work normally.

→ Disconnect the AC power cord (mains lead) from the wall outlet (mains), then reconnect after several minutes.

Messages

[A new software version is available. Please go to the "Setup" section of the menu and select "Software Update" to perform the update.] appears on the TV screen.

→ See [Software Update] (page 21) to update the system to a latest software version.

"PRTCT", "PUSH" and "POWER" appear alternately in the front panel display.

→ Press I/⏻ to turn off the system. After "STBY" disappears, disconnect the AC power cord (mains lead) from the wall outlet (mains). Then, check that nothing is blocking the ventilation holes of the unit. Reconnect the AC power cord (mains lead) and turn on the system. If the problem persists, consult your nearest Sony dealer.

"LOCK" flashes in the front panel display when you press any touch key on the unit.

→ Set the child lock function to off (page 33).

 appears without any messages on the entire TV screen.

→ Contact your nearest Sony dealer or local authorized Sony service facility.

"NOT USE" appears in the front panel display when you press any of the sound effect buttons (page 45).

→ The sound effects setting cannot be changed when the system is connected to a BLUETOOTH receiver in transmitter mode.

"BT TX" appears in the front panel display.

→ Press RX/TX  on the remote control to switch [Bluetooth Mode] to [Receiver]. "BT TX" appears if [Bluetooth Mode] is set to [Transmitter] (page 13). When you

press RX/TX  on the remote control, [Bluetooth Mode] is switched to [Receiver] and the selected input appears in the front panel display (page 24).

Picture

There is no picture or the picture is not output correctly.

- Select the appropriate input (page 8).
- While holding INPUT, touch VOL +, VOL - and VOL + in sequence to reset the video output resolution to the lowest resolution.

There is no picture when you make an HDMI cable connection.

- If you connect a device supporting HDCP2.2, be sure to connect the device to the HDMI IN 1 jack and the TV to the HDMI OUT (ARC) jack of the system.
- The system is connected to an input device that is not HDCP (High-bandwidth Digital Content Protection) compliant. In this case, check the specifications of the connected device.
- Disconnect the HDMI cable, then connect it again. Make sure that the cable is firmly inserted.

3D content from the HDMI IN 1/2/3 jack do not appear on the TV screen.

- Depending on the TV or video device, 3D content may not appear. Check the supported HDMI video format (page 49).

4K content from the HDMI IN 1/2/3 jack do not appear on the TV screen.

- Depending on the TV or the video device, 4K content may not appear. Check the video capability and settings of your TV and video device.

- Use a High Speed HDMI Cable with Ethernet.

No image is output from the TV when the system is in standby mode.

- When the system enters standby mode, the image from the last selected HDMI device before you turned off the system is displayed. If you are enjoying content from another device, play the content on the device and perform the One-Touch Play operation, or turn on the system to select the HDMI device from which you want to enjoy content.
- Set [Standby Through] to [On] in [HDMI Settings] (page 25).

An image is not displayed on the entire TV screen.

- Check the setting of [TV Type] in [Screen Settings] (page 22).
- The aspect ratio on the media is fixed.

Color irregularity occurs on the TV screen.

- If the color irregularity persists, turn off the TV set once, then turn it on after 15 to 30 minutes.
- Make sure that no magnetic object (magnetic latch on a TV stand, health care device, toy, etc.) is placed near the system.

Images from the HDMI jack is distorted.

- Video from the device connected to the HDMI jack may be distorted. If this happens, set [Video Direct] to [On] (page 23).

Sound

No sound or only a very low-level sound of the device connected to the system is heard.

- Press \triangleleft + and check the volume level (page 45).
- Press \times or \triangleleft + to cancel the muting function (page 45).

- Make sure the input source is selected correctly. You should try other input sources by pressing the INPUT +/- repeatedly (page 8).
- Check that all the cables and cords of the system and the connected device are firmly inserted.

No TV sound is output from the system.

- Press INPUT +/- repeatedly to select [TV] input.
- Check the connection of the HDMI cable or optical digital cable that is connected to the system and the TV (refer to Step 1 in the supplied Startup Guide).
- Depending on the order of turning on the TV and the system, the system may enter muting mode and "MUTING" may appear in the front panel display. In this case, turn on the TV first, then the system.
- Set the speaker setting of the TV to Audio System. Refer to the operating instructions of the TV for the TV settings.
- Increase the volume on the TV or cancel muting.
- When a TV compatible with the Audio Return Channel (ARC) function is connected with an HDMI cable, make sure the cable is connected to the HDMI input (ARC) terminal of the TV (refer to Step 1 in the supplied Startup Guide).
- If the TV is not compatible with the Audio Return Channel (ARC) function, connect the optical digital cable in addition to the HDMI cable in order to output sound (refer to Step 1 in the supplied Startup Guide).

The sound is output from both the system and the TV.

- Turn off the sound of the system or the TV.

There is no sound from the TV via the HDMI OUT (ARC) jack when using the Audio Return Channel function.

- Set [Control for HDMI] in [HDMI Settings] of [System Settings] to [On] (page 25). Also, set [Audio Return Channel] in [HDMI Settings] of [System Settings] to [Auto] (page 25).
- Make sure that your TV is compatible with the Audio Return Channel function.
- Make sure that an HDMI cable is connected to a jack on your TV that is compatible with the Audio Return Channel function.

The system does not output sound of TV programs correctly when connected to a set-top box.

- Set [Audio Return Channel] in [HDMI Settings] of [System Settings] to [Off] (page 25).
- Check the connections (refer to the supplied Startup Guide).

Severe hum or noise is heard.

- Check that the devices are connected securely.
- Move your audio device away from the TV.
- The plugs and jacks are dirty. Wipe them with a cloth slightly moistened with alcohol.

Dolby Digital or DTS multi-channel sound is not reproduced.

- Check that the DVD, etc. you are playing is recorded in Dolby Digital or DTS format.
- You can only enjoy High Bitrate Audio (DTS-HD Master Audio, Dolby TrueHD), DSD and Multi Channel Linear PCM with an HDMI connection.

Distortion occurs in the sound of a connected device.

- Reduce the input level for the connected device by setting [Attenuation settings - Analog] (page 23).

Playback

File names are not displayed correctly.

- The system can only display ISO 8859-1 compliant character formats. Other character formats may be displayed differently.
- Depending on the writing software used, the input characters may be displayed differently.

A file does not start playing from the beginning.

- Resume play has been selected. Press OPTIONS and select [Play from start], then press ⊕.

Playback does not start from the resume point where you last stopped playing.

- The resume point may be cleared from memory depending on the file when
 - you disconnect the USB device.
 - you play other content.
 - you turn off the system.

Unstable playback when using Screen mirroring.

- Depending on the usage environment, devices emitting radio waves such as other wireless LAN devices or microwave ovens may interfere with the Screen mirroring. Move the system and the Screen mirroring-compatible device away from such devices, or turn off such devices.

- Depending on the usage environment, communication speed may be affected by the distance or obstacle between devices, types of device, device configuration, or radio waves. Communication may be lost due to line congestion.

USB device

The USB device is not recognized.

- Try the following:
 - ① Turn the system off.
 - ② Remove and reconnect the USB device.
 - ③ Turn the system on.
- Make sure that the USB device is securely connected to the  (USB) port.
- Check if the USB device or a cable is damaged.
- Check if the USB device is on.
- If the USB device is connected via a USB hub, disconnect it and connect the USB device directly to the unit.

"BRAVIA" Sync ([Control for HDMI])

The [Control for HDMI] function does not work ("BRAVIA" Sync).

- Check the HDMI connection (refer to Step 1 in the supplied Startup Guide).
- Check that [Control for HDMI] is set to [On] (page 25).
- If you change the HDMI connection, turn the system off and on again.
- If power failure occurs, set [Control for HDMI] to [Off], then set [Control for HDMI] to [On] (page 25).

- Check the following and refer to the operating instructions supplied with the device.

- The connected device is compatible with the [Control for HDMI] function.
- The connected device's setting for the [Control for HDMI] function is correct.

- If you connect/disconnect the AC power cord (mains lead), wait more than 15 seconds before operating the system.

- If you connect the audio output of video device with the system, using a cable other than an HDMI cable, no sound may be output because of "BRAVIA" Sync. In such a case, set [Control for HDMI] to [Off] (page 25) or connect the cable from the audio output jack of the video device directly to the TV.

- The types and number of devices that can be controlled by the "BRAVIA" Sync feature are restricted by the HDMI CEC standard as follows:
 - Recording devices (Blu-ray Disc™ recorders, DVD recorders, etc.): up to 3 devices
 - Playback devices (Blu-ray Disc™ players, DVD players, etc.): up to 3 devices (including this system)
 - Tuner-related devices: up to 4 devices
 - Audio system (receiver/headphones): up to 1 device (including this system)

Network connection

The system cannot connect to the network.

- Check the network connection (page 15) and the network settings (page 27).

Wireless LAN connection

You cannot connect your PC to the Internet after [Wi-Fi Protected Setup (WPS)] is performed.

- The wireless settings of the router may change automatically if you use the Wi-Fi Protected Setup function before adjusting the settings of the router. In this case, change the wireless settings of your PC accordingly.

The system cannot connect to the network or the network connection is unstable.

- Check if the wireless LAN router is on.
- Check the network connection (page 15) and the network settings (page 27).
- Depending on the usage environment, including the wall material, radio wave reception conditions, or obstacles between the system and the wireless LAN router, the possible communication distance may be shortened. Move the system and the wireless LAN router closer to each other.
- Devices that use a 2.4 GHz frequency band, such as a microwave, BLUETOOTH, or digital cordless device, may interrupt communication. Move the system away from such devices, or turn off such devices.
- The wireless LAN connection may be unstable depending on the usage environment, especially while using the BLUETOOTH function of the system. In this case, adjust the usage environment.

The wireless router you want is not shown in the wireless network list.

- Press BACK to return to the previous screen, and try [Wireless Setup(built-in)] again. If the wireless router you want is still not detected, select [New connection registration] from the network list, then select [Manual registration] to input a network name (SSID) manually.

BLUETOOTH device

BLUETOOTH connection cannot be completed.

- Make sure that the blue LED indicator is lit (page 43).
- Make sure the BLUETOOTH device to be connected is turned on and the BLUETOOTH function is enabled.
- Move the BLUETOOTH device closer to the unit.
- Pair this system and the BLUETOOTH device again. You may need to cancel the pairing with this system using your BLUETOOTH device first.
- Set [Bluetooth Mode] to [Receiver] or [Transmitter] (page 24).

Pairing cannot be done.

- Move the BLUETOOTH device closer to the unit.
- Pairing may not be possible if other BLUETOOTH devices are present around the unit. In this case, turn off the other BLUETOOTH devices.
- Delete the system from your BLUETOOTH device and perform pairing again (page 11).

NFC function does not work.

- NFC function does not work with BLUETOOTH-compatible receivers (such as headphones). To listen to sound using a BLUETOOTH-compatible receiver, see “Listening to sound by transmitting to a BLUETOOTH-compatible receiver” (page 13).

Connecting cannot be done.

- The pairing registration information has been erased. Perform the pairing operation again (page 11).

There is no sound.

- Make sure this unit is not too far from the BLUETOOTH device, or this system is not receiving interference from a Wi-Fi network, other 2.4 GHz wireless device, or microwave oven.
- Check that the BLUETOOTH connection is made properly between this system and the BLUETOOTH device.
- Pair this system and the BLUETOOTH device again.
- Keep the unit away from metal objects or surfaces.
- Make sure [Bluetooth Audio] input is selected.
- Adjust the volume of the BLUETOOTH device first, if the volume level is still too low, adjust the volume level on the unit.

The sound skips or fluctuates, or the connection is lost.

- The unit and the BLUETOOTH device are too far apart.
- If there are obstacles between the unit and your BLUETOOTH device, remove or avoid the obstacles.
- If there is device that generates electromagnetic radiation, such as a wireless LAN, other BLUETOOTH device, or a microwave oven nearby, move them away.



Guide to Parts and Controls

For more information, refer to the pages indicated in parentheses.

Unit

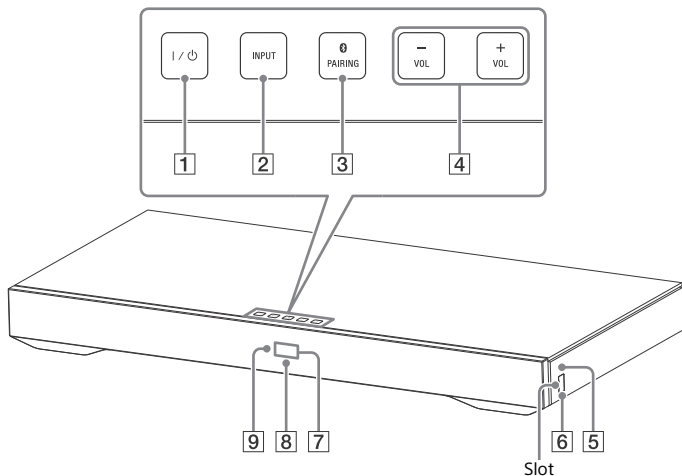
Front/Top/Side



- 1 I/⏻ (on/standby) touch key**
Turns on the system, or sets it to standby mode.
- 2 INPUT touch key**
Selects the device you want to use.
- 3 PAIRING  touch key**
- 4 VOL (volume) +/- touch key**
- 5  (N-Mark) (page 13)**
Position the NFC-compatible device near this indication to activate the NFC function.
- 6  (USB) port (page 8)**
Place your fingernail in the slot to open the cover.
- 7 Front panel display**

- 8 Blue LED indicator**
Shows the BLUETOOTH status as follows.

During BLUETOOTH pairing	Flashes quickly
The system is attempting to connect with a BLUETOOTH device	Flashes
The system has established connection with a BLUETOOTH device	Lights up

- 9 Remote control sensor**

About touch keys

The touch keys work when you touch them lightly. Do not press on them with excessive force.

Removing the grille frame

Remove or attach the grille frame in parallel with the front panel.

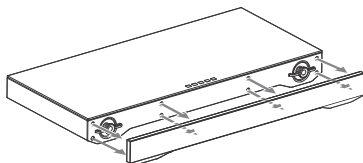

Rear panel

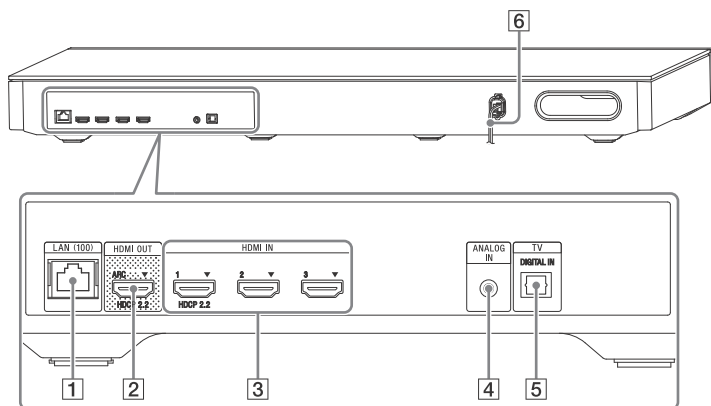

- 1 LAN (100) terminal
- 2 HDMI OUT* (ARC) jack
- 3 HDMI IN 1*/2/3 jacks
- 4 ANALOG IN jack
- 5 TV (DIGITAL IN) jack
- 6 AC power cord (mains lead)

* HDMI IN 1 and HDMI OUT jacks support HDCP 2.2 protocol. HDCP 2.2 is newly enhanced copyright protection technology that is used to protect content such as 4K movies.

Remote control

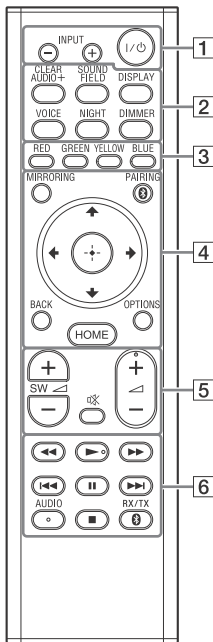

AUDIO, ►, and ◀ + buttons have a tactile dot. Use the tactile dot as a reference when operating the remote control.

- 1 I/⏻ (on/standby)**
Turns on the system or sets it to standby mode.
INPUT +/- (page 8)
Selects the device you want to use.
- 2 Sound effect buttons**
See “Enjoying sound effects” (page 9).
CLEARAUDIO+, SOUND FIELD, VOICE, NIGHT

DISPLAY

Displays playback information on the TV screen.

DIMMER (page 34)

Adjusts the brightness of the front panel display and blue LED indicator.

- 3 Color buttons**
Shortcut keys for selecting items on some menus.
- 4 MIRRORING (page 18)**
Selects the [Screen mirroring] input.
- PAIRING (page 11)**
Sets the system to pairing mode. This button only works when [Bluetooth Mode] is set to [Receiver] (page 24).

BACK

Returns to the previous display.

OPTIONS (pages 12, 14, 28, 29)

Displays the Options menu on the TV screen or in the front panel display. (The location differs depending on the selected function.)

HOME (pages 8, 10, 15, 17, 21)

Enters or exits the system’s home screen.



Moves the highlight to a displayed item.

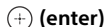

Enters the selected item.

- 5 SW ◀ (subwoofer volume) +/-**
Adjust the volume of the bass sound.
- ⊗ (muting)**
Turns off the sound temporarily.
- ◀ (volume) +/-**
Adjusts the volume.
- 6 Playback operation buttons**
See “Listening/Viewing” (page 8).
◀◀/▶▶ (rewind/fast forward)
Searches backward or forward.

⏮/⏭ (previous/next)

Selects the previous/next track or file.

▶ (play)

Starts or re-starts playback (resume play).

⏸ (pause)

Pauses or re-starts playback.

■ (stop)

Stops playback.

AUDIO (page 33)

Selects the audio format.

RX/TX

Switches the [Bluetooth Mode] to [Receiver] or [Transmitter] (page 24).

Playable types of files

Music

Codec	Extension
MP3 (MPEG-1 Audio Layer III) ^{*4}	.mp3
AAC/HE-AAC ^{*1*4}	.m4a, .aac ^{*2}
WMA9 Standard ^{*1}	.wma
WMA 10 Pro ^{*2}	.wma
LPCM ^{*4}	.wav
FLAC ^{*1}	.flac, .fla
Dolby Digital ^{*2*4}	.ac3
DSF ^{*1}	.dsf
DSDIFF ^{*1*5}	.dff
AIFF ^{*1}	.aiff, .aif
ALAC ^{*1}	.m4a
Vorbis ^{*2}	.ogg
Monkey's Audio ^{*2}	.ape

Photo

Format	Extension
JPEG	.jpeg, .jpg, .jpe
PNG	.png ^{*3}

Format	Extension
GIF	.gif ^{*3}

- ^{*1} The system may not play this file format on a Home Network server.
- ^{*2} The system does not play this file format on a Home Network server.
- ^{*3} The system does not play animated PNG or animated GIF files.
- ^{*4} The system can play ".mka" files. This file cannot be played on a Home Network server.
- ^{*5} The system does not play DST encoded files.

Note

- Some files may not play depending on the file format, the file encoding, the recording condition, or Home Network server condition.
- Some files edited on a PC may not play.
- Some files may not be able to perform fast forward or fast reverse function.
- The system does not play 3D photo files.
- The system does not play coded files such as DRM and Lossless.
- The system can recognize the following files or folders in USB devices:
 - up to folders in the 9th layer (including the root folder)
 - up to 500 files/folders in a single layer
- The system can recognize the following files or folders stored in the Home Network server:
 - up to folders in the 19th layer
 - up to 999 files/folders in a single layer
- Some USB devices may not work with this system.
- The system can recognize Mass Storage Class (MSC) devices (such as flash memory or an HDD), Still Image Capture Devices (SICDs), and 101-key keyboards.

Supported audio formats

Audio formats supported by this system are as follows.

Format	Input	
	[HDMI1] [HDMI2] [HDMI3]	[TV] (DIGITAL IN)
LPCM 2ch	○	○
LPCM 5.1ch	○	-
LPCM 7.1ch	○	-
Dolby Digital	○	○
Dolby TrueHD, Dolby Digital Plus	○	-
DTS	○	○
DTS-ES Discrete 6.1, DTS-ES Matrix 6.1	○*	○*
DTS96/24	○*	○*
DTS-HD High Resolution Audio	○	-
DTS-HD Master Audio	○	-
DTS-HD Low Bit Rate	○	-
DSD	○	-

○: Supported format.

-: Unsupported format.

* Decoded as DTS core.

Specifications

Amplifier section

POWER OUTPUT (rated)

Front L + Front R:

50 W + 50 W (at 4 ohms, 1 kHz, 1% THD)

POWER OUTPUT (reference)

Front L/Front R speaker:

115 W (per channel at 4 ohms, 1 kHz)

Subwoofer:

120 W (at 4 ohms, 80 Hz)

Inputs

HDMI IN 1*/2/3

TV (DIGITAL IN)

ANALOG IN

Output

HDMI OUT* (ARC)

* HDMI IN 1 and HDMI OUT jacks support HDCP 2.2 protocol. HDCP 2.2 is newly enhanced copyright protection technology that is used to protect content such as 4K movies.

HDMI section

Connector

Type A (19pin)

USB section

⚡ (USB) port:

Type A (For connecting USB memory, memory card reader, and digital still camera)

LAN section

LAN (100) terminal

100BASE-TX Terminal

Wireless LAN section

Standards Compliance

IEEE 802.11 a/b/g/n

Frequency band

2.4 GHz, 5 GHz

BLUETOOTH section

Communication system

BLUETOOTH Specification version 3.0

Output

BLUETOOTH Specification Power Class 1

Maximum communication range

Line of sight approx. 30 m¹⁾

- Frequency band
 - 2.4 GHz
- Modulation method
 - FHSS (Freq Hopping Spread Spectrum)
- Compatible BLUETOOTH profiles²⁾
 - A2DP 1.2 (Advanced Audio Distribution Profile)
 - AVRCP 1.5 (Audio Video Remote Control Profile)
- Supported Codecs³⁾
 - SBC⁴⁾, AAC, LDAC
- Transmission range (A2DP)
 - 20 Hz – 20,000 Hz (Sampling frequency 44.1 kHz, 48 kHz, 88.2 kHz, 96 kHz)

¹⁾ The actual range will vary depending on factors such as obstacles between devices, magnetic fields around a microwave oven, static electricity, cordless phone, reception sensitivity, antenna's performance, operating system, software application, etc.

²⁾ BLUETOOTH standard profiles indicate the purpose of BLUETOOTH communication between devices.

³⁾ Codec: Audio signal compression and conversion format

⁴⁾ Subband Codec

Front L/Front R speaker section

- Speaker system
 - 2-way speaker system, Acoustic suspension

Speaker

- Woofer: 65 mm cone type, magnetic fluid speaker ×2

- Tweeter: 18 mm dome type ×2

Subwoofer section

- Speaker system
 - Subwoofer system
 - Bass reflex

Speaker

- 110 mm cone type ×2

General

- Power requirements
 - 220 V – 240 V AC, 50/60 Hz

- Power consumption

- On: 68 W

- Standby:

- 0.3 W (For details on the setting, see page 34.)

- 5.5 W (When [Remote Start], [Quick Start/Network Standby]

- and [Control for HDMI] are set to [On], and [Standby Through] is set to [Auto] when TV is not connected.)

- Dimensions (w/h/d) (approx.)

- 750 mm × 83 mm × 358 mm incl. projecting parts

- Mass (approx.)

- 10.5 kg

Video formats supported by the system

Input/Output (HDMI Repeater block)

Format	2D	3D		
		Frame packing	Side-by-Side (Half)	Over-Under (Top-and-Bottom)
4096 × 2160p @ 59.94/60 Hz ^{*1}	○	-	-	-
4096 × 2160p @ 50 Hz ^{*1}	○	-	-	-
4096 × 2160p @ 23.98/24 Hz ^{*2}	○	-	-	-
3840 × 2160p @ 59.94/60 Hz ^{*1}	○	-	-	-
3840 × 2160p @ 50 Hz ^{*1}	○	-	-	-
3840 × 2160p @ 29.97/30 Hz ^{*2}	○	-	-	-
3840 × 2160p @ 25 Hz ^{*2}	○	-	-	-
3840 × 2160p @ 23.98/24 Hz ^{*2}	○	-	-	-
1920 × 1080p @ 59.94/60 Hz	○	-	○	○
1920 × 1080p @ 50 Hz	○	-	○	○
1920 × 1080p @ 29.97/30 Hz	○	○	○	○
1920 × 1080p @ 25 Hz	○	○	○	○
1920 × 1080p @ 23.98/24 Hz	○	○	○	○
1920 × 1080i @ 59.94/60 Hz	○	○	○	○
1920 × 1080i @ 50 Hz	○	○	○	○
1280 × 720p @ 59.94/60 Hz	○	○	○	○
1280 × 720p @ 50 Hz	○	○	○	○
1280 × 720p @ 29.97/30 Hz	○	○	○	○
1280 × 720p @ 23.98/24 Hz	○	○	○	○
720 × 480p @ 59.94/60 Hz	○	-	-	-
720 × 576p @ 50 Hz	○	-	-	-
640 × 480p @ 59.94/60 Hz	○	-	-	-

^{*1} YCbCr 4:2:0/Supported 8-bit only

^{*2} Supported 8-bit only

Design and specifications are subject to change without notice.

On BLUETOOTH communication

Supported BLUETOOTH version and profiles

Profile refers to a standard set of functions for various BLUETOOTH product features. See “BLUETOOTH section” in “Specifications” (page 47) for the BLUETOOTH version and profiles supported by this system.

Effective communication range

BLUETOOTH devices should be used within approximately 10 meters (unobstructed distance) of each other. The effective communication range may become shorter under the following conditions.

- When a person, metal object, wall or other obstruction is between the devices with a BLUETOOTH connection
- Locations where a wireless LAN is installed
- Around microwave ovens that are in use
- Locations where other electromagnetic waves are generated

Effects of other devices

BLUETOOTH devices and wireless LAN (IEEE 802.11b/g/n) device use the same frequency band (2.4 GHz). When using your BLUETOOTH device near a device with wireless LAN capability, electromagnetic interference may occur. This could result in lower data transfer rates, noise, or inability to connect. If this happens, try the following remedies:

- Use this system at least 10 meters away from the wireless LAN device.
- Turn off the power to the wireless LAN device when using your BLUETOOTH device within 10 meters.

- Install this system and BLUETOOTH device as closer to each other as possible.

Effects on other devices

The radio waves broadcast by this system may interfere with the operation of some medical devices. Since this interference may result in malfunction, always turn off the power on this system and BLUETOOTH device in the following locations:

- In hospitals, on trains, in airplanes, at gas stations, and any place where flammable gasses may be present
- Near automatic doors or fire alarms

Note

- This system supports security functions that comply with the BLUETOOTH specification to ensure secure connection during communication using BLUETOOTH technology. However, this security may be insufficient depending on the setting contents and other factors, so always be careful when performing communication using BLUETOOTH technology.
- Sony shall not be held liable in any way for damages or other loss resulting from information leaks during communication using BLUETOOTH technology.
- BLUETOOTH communication is not necessarily guaranteed with all BLUETOOTH devices that have the same profile as this system.
- BLUETOOTH devices connected with this system must comply with the BLUETOOTH specification prescribed by the Bluetooth SIG, Inc., and must be certified to comply. However, even when a device complies with the BLUETOOTH specification, there may be cases where the characteristics or specifications of the BLUETOOTH device make it impossible to connect, or may result in different control methods, display or operation.
- Noise may occur or the audio may cut off depending on the BLUETOOTH device connected with this system, the communications environment, or surrounding conditions.

Index

Numerics

- 24p Output 22
- 4K Output 22

A

- A/V SYNC 29
- Attenuation settings - Analog 23
- Audio DRC 23
- Audio Output 23
- Audio Return Channel 25
- Audio Settings 23
- Auto Display 26
- Auto Renderer Access Permission 27
- Auto Standby 26
- Auto Update 26
- Auto Update Settings 26

B

- BLUETOOTH 11
- Bluetooth Codec - AAC 24
- Bluetooth Codec - LDAC 24
- Bluetooth Mode 24
- Bluetooth Settings 24
- Bluetooth Standby 24
- BRAVIA Sync 31

C

- Child Lock 33
- Clear Voice 10
- Connection Server Settings 27
- Control for HDMI 25, 31

D

- Device List 24
- Device Name 26
- Dimmer 34
- DSEE HX 10, 23

E

- Easy Network Settings 28
- Easy Setup 28
- External Control 27

F

- Front panel 43

G

- Google Cast 18

H

- HDMI
 - YCbCr/RGB (HDMI) 22
- HDMI Deep Colour Output 23
- HDMI1 Audio Input Mode 26
- Home Network 16, 27

I

- Initialise Personal Information 28
- Input Skip Setting 27
- Internet Settings 27

M

- Multiplex broadcast sound 33

N

- Network Connection Diagnostics 27
- Network Settings 27
- NFC 12, 19
- Night mode 10

O

- OSD Language 25
- Output Video Resolution 22

Q

- Quick Start/Network Standby 26

R

- Rear panel 44
- Remote control 45
- Remote Start 27
- Renderer Access Control 27
- Reset to Factory Default Settings 28
- Resetting 28

S

- SBM 23
- Screen mirroring 18
- Screen mirroring RF Setting 27
- Screen Settings 22
- Slideshow 29
- Software License Information 26
- Software Update 21
- SongPal 30
- Standby Through 25
- System Information 26
- System Settings 25

T

- Time Zone 26
- Top panel 43
- TV Type 22

U

- USB 8

V

- Video Direct 23

W

- Wireless Playback Quality 25

END USER LICENSE AGREEMENT

IMPORTANT:

BEFORE USING THE SOFTWARE, PLEASE READ THIS END USER LICENSE AGREEMENT ("EULA") CAREFULLY. BY USING THE SOFTWARE YOU ARE ACCEPTING THE TERMS OF THIS EULA. IF YOU DO NOT ACCEPT THE TERMS OF THIS EULA, YOU MAY NOT USE THE SOFTWARE.

This EULA is a legal agreement between you and Sony Corporation ("SONY"). This EULA governs your rights and obligations regarding the SONY software of SONY and/or its third party licensors (including SONY's affiliates) and their respective affiliates (collectively, the "THIRD-PARTY SUPPLIERS"), together with any updates/upgrades provided by SONY, any printed, on-line or other electronic documentation for such software, and any data files created by operation of such software (collectively, the "SOFTWARE").

Notwithstanding the foregoing, any software in the SOFTWARE having a separate end user license agreement (including, but not limited to, GNU General Public license and Lesser/Library General Public License) shall be covered by such applicable separate end user license agreement in lieu of the terms of this EULA to the extent required by such separate end user license agreement ("EXCLUDED SOFTWARE").

SOFTWARE LICENSE

The SOFTWARE is licensed, not sold. The SOFTWARE is protected by copyright and other intellectual property laws and international treaties.

COPYRIGHT

All right and title in and to the SOFTWARE (including, but not limited to, any images, photographs, animation, video, audio, music, text and "applets" incorporated into the SOFTWARE) is owned by SONY or one or more of the THIRD-PARTY SUPPLIERS.

GRANT OF LICENSE

SONY grants you a limited license to use the SOFTWARE solely in connection with your compatible device ("DEVICE") and only for your individual, non-commercial use. SONY and the THIRD-PARTY SUPPLIERS expressly reserve all rights, title and interest (including, but not limited to, all intellectual property rights) in and to the SOFTWARE that this EULA does not specifically grant to you.

REQUIREMENTS AND LIMITATIONS

You may not copy, publish, adapt, redistribute, attempt to derive source code, modify, reverse engineer, decompile, or disassemble any of the SOFTWARE, whether in whole or in part, or create any derivative works from or of the SOFTWARE unless such derivative works are intentionally facilitated by the SOFTWARE. You may not modify or tamper with any digital rights management functionality of the SOFTWARE. You may not bypass, modify, defeat or circumvent any of the functions or protections of the SOFTWARE or any mechanisms operatively linked to the SOFTWARE. You may not separate any individual component of the SOFTWARE for use on more than one DEVICE unless expressly authorized to do so by SONY. You may not remove, alter, cover or deface any trademarks or notices on the SOFTWARE. You may not share, distribute, rent, lease, sublicense, assign, transfer or sell the SOFTWARE. The software, network services or other products other than SOFTWARE upon which the SOFTWARE'S performance depends might be interrupted or discontinued at the discretion of the suppliers (software suppliers, service suppliers, or SONY). SONY and such suppliers do not warrant that the SOFTWARE, network services, contents or other products will continue to be available, or will operate without interruption or modification.

USE OF SOFTWARE WITH COPYRIGHTED MATERIALS

The SOFTWARE may be capable of being used by you to view, store, process and/or use content created by you and/or third parties. Such content may be protected by copyright, other intellectual property laws, and/or agreements. You agree to use the SOFTWARE only in compliance with all such laws and agreements that apply to such content. You acknowledge and agree that SONY may take appropriate measures to protect the copyright of content stored, processed or used by the SOFTWARE. Such measures include, but are not limited to, counting the frequency of your backup and restoration through certain SOFTWARE features, refusal to accept your request to enable restoration of data, and termination of this EULA in the event of your illegitimate use of the SOFTWARE.

CONTENT SERVICE

PLEASE ALSO NOTE THAT THE SOFTWARE MAY BE DESIGNED TO BE USED WITH CONTENT AVAILABLE THROUGH ONE OR MORE CONTENT SERVICES ("CONTENT SERVICE"). USE OF THE SERVICE AND THAT CONTENT IS SUBJECT TO THE TERMS OF SERVICE OF THAT CONTENT SERVICE. IF YOU DECLINE TO ACCEPT THOSE TERMS, YOUR USE OF THE SOFTWARE WILL BE LIMITED. You acknowledge and agree that certain content and services available through the SOFTWARE may be provided by third parties over which SONY has no control. USE OF THE CONTENT SERVICE REQUIRES AN INTERNET CONNECTION. THE CONTENT SERVICE MAY BE DISCONTINUED AT ANY TIME.

INTERNET CONNECTIVITY AND THIRD PARTY SERVICES

You acknowledge and agree that access to certain SOFTWARE features may require an Internet connection for which you are solely responsible. Further, you are solely responsible for payment of any third party fees associated with your Internet connection, including but not limited to Internet service provider or airtime charges. Operation of the SOFTWARE may be limited or restricted depending on the capabilities, bandwidth or technical limitations of your Internet connection and service. The provision, quality and security of such Internet connectivity are the sole responsibility of the third party providing such service.

EXPORT AND OTHER REGULATIONS

You agree to comply with all applicable export and re-export restrictions and regulations of the area or country in which you reside, and not to transfer, or authorize the transfer, of the SOFTWARE to a prohibited country or otherwise in violation of any such restrictions or regulations.

HIGH RISK ACTIVITIES

The SOFTWARE is not fault-tolerant and is not designed, manufactured or intended for use or resale as on-line control equipment in hazardous environments requiring fail-safe performance, such as in the operation of nuclear facilities, aircraft navigation or communication systems, air traffic control, direct life support machines, or weapons systems, in which the failure of the SOFTWARE could lead to death, personal injury, or severe physical or environmental damage ("HIGH RISK ACTIVITIES"). SONY, each of the THIRD-PARTY SUPPLIERS, and each of their respective affiliates specifically disclaim any express or implied warranty, duty or condition of fitness for HIGH RISK ACTIVITIES.

EXCLUSION OF WARRANTY ON SOFTWARE

You acknowledge and agree that use of the SOFTWARE is at your sole risk and that you are responsible for use of the SOFTWARE. The SOFTWARE is provided "AS IS," without warranty, duty or condition of any kind.

SONY AND EACH OF THE THIRD-PARTY SUPPLIERS (for purposes of this Section, SONY and each of the THIRD-PARTY SUPPLIERS shall be collectively referred to as "SONY") EXPRESSLY DISCLAIM ALL WARRANTIES, DUTIES OR CONDITIONS, EXPRESS OR IMPLIED, INCLUDING, BUT NOT LIMITED TO, THE IMPLIED WARRANTIES OF MERCHANTABILITY, NONINFRINGEMENT AND FITNESS FOR A PARTICULAR PURPOSE. SONY DOES NOT WARRANT OR MAKE ANY CONDITIONS OR REPRESENTATIONS (A) THAT THE FUNCTIONS CONTAINED IN ANY OF THE SOFTWARE WILL MEET YOUR REQUIREMENTS OR THAT THEY WILL BE UPDATED, (B) THAT THE OPERATION OF ANY OF THE SOFTWARE WILL BE CORRECT OR ERROR-FREE OR THAT ANY DEFECTS WILL BE CORRECTED, (C) THAT THE SOFTWARE WILL NOT DAMAGE ANY OTHER SOFTWARE, HARDWARE OR DATA, (D) THAT ANY SOFTWARE, NETWORK SERVICES (INCLUDING THE INTERNET) OR PRODUCTS (OTHER THAN THE SOFTWARE) UPON WHICH THE SOFTWARE'S PERFORMANCE DEPENDS WILL CONTINUE TO BE AVAILABLE, UNINTERRUPTED OR UNMODIFIED, AND (E) REGARDING THE USE OR THE RESULTS OF THE USE OF THE SOFTWARE IN TERMS OF ITS CORRECTNESS, ACCURACY, RELIABILITY, OR OTHERWISE.

NO ORAL OR WRITTEN INFORMATION OR ADVICE GIVEN BY SONY OR AN AUTHORIZED REPRESENTATIVE OF SONY SHALL CREATE A WARRANTY, DUTY OR CONDITION OR IN ANY WAY INCREASE THE SCOPE OF THIS WARRANTY. SHOULD THE SOFTWARE PROVE DEFECTIVE YOU ASSUME THE ENTIRE COST OF ALL NECESSARY SERVICING, REPAIR OR CORRECTION. SOME JURISDICTIONS DO NOT ALLOW THE EXCLUSION OF IMPLIED WARRANTIES, SO THESE EXCLUSIONS MAY NOT APPLY TO YOU.

LIMITATION OF LIABILITY

SONY AND EACH OF THE THIRD-PARTY SUPPLIERS (for purposes of this Section, SONY and each of the THIRD-PARTY SUPPLIERS shall be collectively referred to as "SONY") SHALL NOT BE LIABLE FOR ANY INCIDENTAL OR CONSEQUENTIAL DAMAGES FOR BREACH OF ANY EXPRESS OR IMPLIED WARRANTY, BREACH OF CONTRACT, NEGLIGENCE, STRICT LIABILITY OR UNDER ANY OTHER LEGAL THEORY RELATED TO THE SOFTWARE, INCLUDING, BUT NOT LIMITED TO, ANY DAMAGES ARISING OUT OF LOSS OF PROFITS, LOSS OF REVENUE, LOSS OF DATA, LOSS OF USE OF THE SOFTWARE OR ANY ASSOCIATED HARDWARE, DOWNTIME AND USER'S TIME, EVEN IF ANY OF THEM HAVE BEEN ADVISED OF THE POSSIBILITY OF SUCH DAMAGES. IN ANY CASE, EACH AND ALL OF THEIR AGGREGATE LIABILITY UNDER ANY PROVISION OF THIS EULA SHALL BE LIMITED TO THE AMOUNT ACTUALLY PAID FOR THE PRODUCT. SOME JURISDICTIONS DO NOT ALLOW THE EXCLUSION OR LIMITATION OF INCIDENTAL OR CONSEQUENTIAL DAMAGES, SO THE ABOVE EXCLUSION OR LIMITATION MAY NOT APPLY TO YOU.

AUTOMATIC UPDATE FEATURE

From time to time, SONY or the THIRD-PARTY SUPPLIERS may automatically update or otherwise modify the SOFTWARE, including, but not limited to, for purposes of enhancement of security functions, error correction and improvement of functions, at such time as you interact with SONY's or third parties' servers, or otherwise. Such updates or modifications may delete or change the nature of features or other aspects of the SOFTWARE, including, but not limited to, functions you may rely upon. You acknowledge and agree that such activities may occur at SONY's sole discretion and that SONY may condition continued use of the SOFTWARE upon your complete installation or acceptance of such update or modifications. Any updates/modifications shall be deemed to be, and shall constitute part of, the SOFTWARE for purposes of this EULA. By acceptance of this EULA, you consent to such update/modification.

ENTIRE AGREEMENT, WAIVER, SEVERABILITY

This EULA and SONY's privacy policy, each as amended and modified from time to time, together constitute the entire agreement between you and SONY with respect to the SOFTWARE. The failure of SONY to exercise or enforce any right or provision of this EULA shall not constitute a waiver of such right or provision. If any part of this EULA is held invalid, illegal, or unenforceable, that provision shall be enforced to the maximum extent permissible so as to maintain the intent of this EULA, and the other parts will remain in full force and effect.

GOVERNING LAW AND JURISDICTION

The United Nations Convention on Contracts for the International Sale of Goods shall not apply to this EULA. This EULA shall be governed by the laws of Japan, without regards to conflict of laws provisions. Any dispute arising out of this EULA shall be subject to the exclusive venue of the Tokyo District Court in Japan, and the parties hereby consent to the venue and jurisdiction of such courts.

EQUITABLE REMEDIES

Notwithstanding anything contained in this EULA to the contrary, you acknowledge and agree that any violation of or non-compliance with this EULA by you will cause irreparable harm to SONY, for which monetary damages would be inadequate, and you consent to SONY obtaining any injunctive or equitable relief that SONY deems necessary or appropriate in such circumstances. SONY may also take any legal and technical remedies to prevent violation of and/or to enforce this EULA, including, but not limited to, immediate termination of your use of the SOFTWARE, if SONY believes in its sole discretion that you are violating or intend to violate this EULA. These remedies are in addition to any other remedies SONY may have at law, in equity or under contract.

TERMINATION

Without prejudice to any of its other rights, SONY may terminate this EULA if you fail to comply with any of its terms. In case of such termination, you must cease all use, and destroy any copies, of the SOFTWARE.

AMENDMENT

SONY RESERVES THE RIGHT TO AMEND ANY OF THE TERMS OF THIS EULA AT ITS SOLE DISCRETION BY POSTING NOTICE ON A SONY DESIGNATED WEB SITE, BY EMAIL NOTIFICATION TO AN EMAIL ADDRESS PROVIDED BY YOU, BY PROVIDING NOTICE AS PART OF THE PROCESS IN WHICH YOU OBTAIN UPGRADES/UPDATES OR BY ANY OTHER LEGALLY RECOGNIZABLE FORM OF NOTICE. If you do not agree to the amendment, you should promptly contact SONY for instructions. Your continued use of the SOFTWARE after the effective date of any such notice shall be deemed your agreement to be bound by such amendment.

THIRD-PARTY BENEFICIARIES

Each THIRD-PARTY SUPPLIER is an express intended third-party beneficiary of, and shall have the right to enforce, each provision of this EULA with respect to the SOFTWARE of such party.

Should you have any questions concerning this EULA, you may contact SONY by writing to SONY at applicable contact address of each area or country.

Copyright © 2014 Sony Corporation.

The software of this system may be updated in the future. To find out details on any available updates, please visit the following URL.

For customers in Europe and Russia:
www.sony.eu/support

For customers in other countries/regions:
<http://www.sony-asia.com/section/support>



<http://www.sony.net/>



* 4 5 5 8 5 6 1 1 5 * (1)