

Digital Surround Headphone System

Operating Instructions

MDR-DS6500

WARNING

To reduce the risk of fire or electric shock, do not expose this apparatus to dripping or splashing, and do not place objects filled with liquids, such as vases, on the apparatus.

To avoid electrical shock, do not open the cabinet. Refer servicing to qualified personnel only.

Do not install the appliance in a confined space, such as a bookcase or built-in cabinet.

The nameplate is located on the bottom of the processor.

As the main plug of AC power adaptor is used to disconnect the AC power adaptor from the mains, connect it to an easily accessible AC outlet. Should you notice an abnormality in it, disconnect it from the AC outlet immediately.

AC power adaptor is not disconnected from the mains as long as it is connected to the AC outlet, even if the unit itself has been turned off.

Do not expose the batteries (battery pack or batteries installed) to excessive heat such as sunshine, fire or the like for a long time.

Excessive sound pressure from earphones and headphones can cause hearing loss.

CAUTION

You are cautioned that any changes or modifications not expressly approved in this manual could void your authority to operate this equipment.

Notice for customers: the following information is only applicable to equipment sold in countries applying EU directives

This product has been manufactured by or on behalf of Sony Corporation, 1-7-1 Konan Minato-ku Tokyo, 108-0075 Japan. Inquiries related to product compliance based on European Union legislation shall be addressed to the authorized representative, Sony Belgium, bijkantoor van Sony Europe Limited, Da Vincilaan 7-D1, 1935 Zaventem, Belgium. For any service or guarantee matters, please refer to the addresses provided in the separate service or guarantee documents.

The validity of the CE marking is restricted to only those countries where it is legally enforced, mainly in the countries EEA (European Economic Area).



Hereby, Sony Corporation declares that this equipment is in compliance with Directive 2014/53/EU.

The full text of the EU declaration of conformity is available at the following internet address:

<http://www.compliance.sony.de/>

Italy: Use of the RLAN network is governed:

- with respect to private use, by the Legislative Decree of 1.8.2003, no. 259 (“Code of Electronic Communications”). In particular Article 104 indicates when the prior obtainment of a general authorization is required and Art. 105 indicates when free use is permitted;
- with respect to the supply to the public of the RLAN access to telecom networks and services, by the Ministerial Decree 28.5.2003, as amended, and Art. 25 (general authorization for electronic communications networks and services) of the Code of electronic communications.

Norway: Use of this radio equipment is not allowed in the geographical area within a radius of 20 km from the centre of Ny-Alesund, Svalbard.

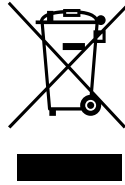

Disposal of Old Electrical & Electronic Equipment (Applicable in the European Union and other European countries with separate collection systems)

This symbol on the product or on its packaging indicates that this product shall not be treated as household waste. Instead it shall be handed over to the applicable collection point for the recycling of electrical and electronic equipment. By ensuring this product is disposed of correctly, you will help prevent potential negative consequences for the environment and human health, which could otherwise be caused by inappropriate waste handling of this product. The recycling of materials will help to conserve natural resources. For more detailed information about recycling of this product, please contact your local Civic Office, your household waste disposal service or the shop where you purchased the product.

(Continued)



Disposal of waste batteries (applicable in the European Union and other European countries with separate collection systems)

For more detailed information about recycling of this product or battery, please contact your local Civic Office, your household waste disposal service or the shop where you purchased the product.

This symbol on the battery or on the packaging indicates that the battery provided with this product shall not be treated as household waste.

On certain batteries this symbol might be used in combination with a chemical symbol. The chemical symbols for mercury (Hg) or lead (Pb) are added if the battery contains more than 0.0005% mercury or 0.004% lead. By ensuring these batteries are disposed of correctly, you will help prevent potentially negative consequences for the environment and human health which could otherwise be caused by inappropriate waste handling of the battery. The recycling of the materials will help to conserve natural resources.

In case of products that for safety, performance or data integrity reasons require a permanent connection with an incorporated battery, this battery should be replaced by qualified service staff only. To ensure that the battery will be treated properly, hand over the product at end-of-life to the applicable collection point for the recycling of electrical and electronic equipment.

For all other batteries, please view the section on how to remove the battery from the product safely. Hand the battery over to the applicable collection point for the recycling of waste batteries.

Table Of Contents

Main Features	6
Checking the Components and Accessories.....	7
Location and Function of Parts.....	8
Processor Part Descriptions.....	8
Headphones Part Descriptions.....	10
Charging the Headphones.....	11
Checking the remaining battery power	13
Connecting the Headphone System	14
Connecting the processor to digital components.....	14
Connecting the processor to analog components.....	15
Listening to a Connected Component	17
Replacing the Ear Pads.....	24
Troubleshooting	25
Precautions	29
Specifications.....	30

Main Features

The MDR-DS6500 is a digital surround headphone system that allows you to enjoy the surround sound field of a BD/DVD or other multi-channel source wirelessly.

You can enjoy multi-channel surround sound with headphones by simply connecting the digital surround processor to a BD/DVD device, digital satellite/TV receiver, GAME device or other device with the supplied cable.

- 7.1ch VPT (Virtualphones Technology)*¹ reproduces the three-dimensional surround of multi-channel speakers.
- Large size 40 mm driver units for premium movie theater sound quality.
- Wireless transmission means you can use these headphones anywhere indoors without worrying about things getting in the way. CD sound quality achieved by uncompressed digital transmission. (Transmission distance: Up to approx. 100 m*²)
- Selectable surround mode. (CINEMA/GAME/VOICE (STEREO))
- Automatic tuning on headphones for the best reception of signal. The system can switch to a free channel automatically without any sound interruption before the signal is blocked.
- Fast recharging function with secure charging mechanism.
- Long playback time. (approx. 20 hours)
- Wide variety of media formats supported.
(Max. 7.1ch sound field achieved by Dolby Pro Logic IIX support*³. Supported media formats: Dolby Digital, Dolby Digital Surround EX, DTS, DTS-ES Matrix, and DTS-ES Discrete)

*¹ "Virtualphones Technology" is a registered trademark of Sony Corporation.

*² Transmission distance varies depending on condition of use.

*³ The processor of this system incorporates the Dolby Digital decoder, Dolby Pro Logic IIX decoder, and DTS decoder.

The processor of this system is manufactured under license from Dolby Laboratories and Digital Theater Systems, Inc.

Manufactured under license from Dolby Laboratories. Dolby, Pro Logic, and the double-D symbol are trademarks of Dolby Laboratories.

Manufactured under license under U.S. Patent #'s: 5,451,942; 5,956,674; 5,974,380; 5,978,762; 6,487,535 & other U.S. and worldwide patents issued & pending. DTS and the Symbol are registered trademarks & DTS Digital Surround and the DTS logos are trademarks of DTS, Inc. Product includes software. © DTS, Inc. All Rights Reserved.

Checking the Components and Accessories

Before setting up the system, check that all of the components are included.

Processor DP-RF6500 (1)

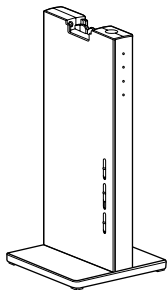

Wireless stereo headphones MDR-RF6500 (1)

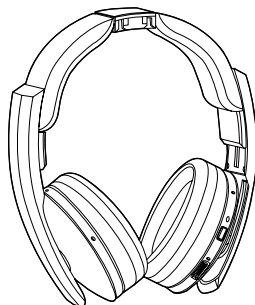

AC power adaptor (1)

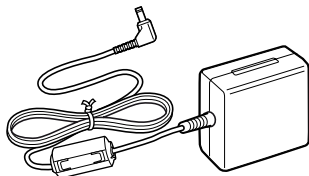

**Optical digital connecting cable
(rectangular type ↔ rectangular type) (1)**

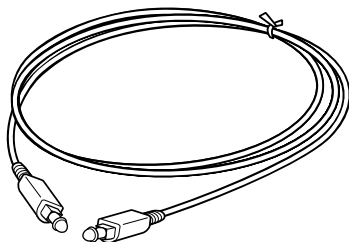

Location and Function of Parts

Processor Part Descriptions

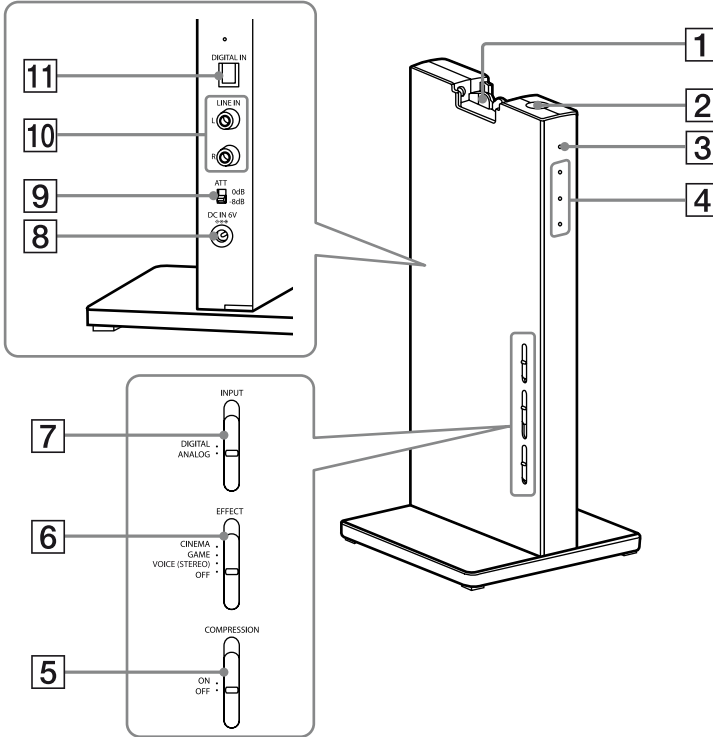

1 Contact pin

2 I / ⏻ (on/standby) button

3 Power indicator

Lights up in green while emitting RF signals.

4 Decode Mode indicators

(See page 20 for details.)

5 COMPRESSION switch

(See page 19 for details.)

6 EFFECT switch

(See page 19 for details.)

Slide to select the sound field (CINEMA/ GAME/VOICE (STEREO)/OFF).

7 INPUT switch

(See page 18 for details.)

Slide to select the input source (DIGITAL/ ANALOG).

8 DC IN 6V jack

Connect the supplied AC power adaptor to this jack. (Be sure to use the supplied AC power adaptor. Using products with a different plug polarity or other characteristics can cause a malfunction.)

9 ATT (attenuator) switch

Set this switch to “0 dB” if the volume is too low for analog input. Normally, this switch should be set to “-8 dB.”

10 LINE IN jacks

(See page 15 for details.)

Connect the audio output jacks on an audio or video component (sold separately), such as a video cassette player or TV, stereo system, VCR, etc. to these jacks.

11 DIGITAL IN jack

(See page 14 for details.)

Connect a BD/DVD device, digital satellite/TV receiver, or other digital component (sold separately) to this jack.

Headphones Part Descriptions

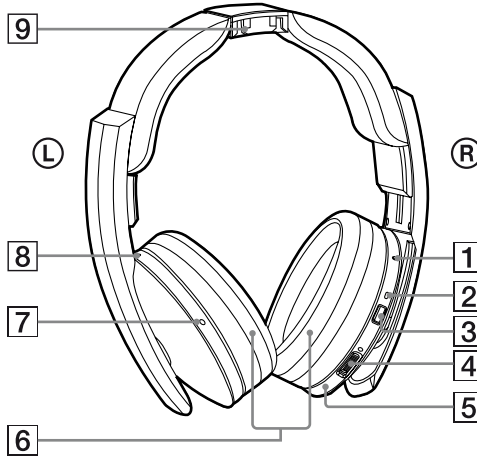

1 Reset button

2 Power indicator

The power indicator lights up in green when the power is on.

3 POWER button

4 VOL (Volume) control*

Use to adjust the volume.

5 Right housing

6 Ear pad

7 Left housing*

8 Charging indicator

Lights up in red while charging.

9 Contact point

* There is a tactile dot on the headphones for easy recognition.

Charging the Headphones

The headphones contain a rechargeable Lithium-Ion battery.

Be sure to charge it before using for the first time.

To charge the headphones, place them on the processor.

1 Connect the supplied AC power adaptor to the processor.

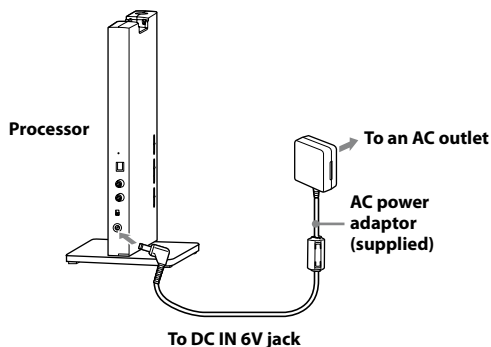

Notes

- Be sure to use the supplied AC power adaptor. Using AC adaptors with different plug polarity or other characteristics can cause product failure.



Unified polarity plug

- Be sure to always use the supplied AC power adaptor. Even AC power adaptors having the same voltage and plug polarity can damage this product due to the current capacity or other factors.
- Connect the AC power adaptor to an easily accessible AC outlet. Should you notice an abnormality in the AC power adaptor, disconnect it from the AC outlet immediately.

(Continued)

2 Rest the headphones on the processor so that the headphones' contact point meets the processor's contact pin, and make sure that the charging indicator lights up.

It takes approx. 3 hours to fully charge the battery (the charging indicator goes off when charging is complete).

When placing the headphones on the processor, be sure to hold them with both hands so that the right and left housings are horizontal, and place the headphones vertically on the processor. When the processor's contact pin meets the headphones' contact point correctly, you can hear a click sound and the charging indicator lights up.

Charging is completed in about 3 hours and the charging indicator lights off, there is no need to remove the headphones from the processor after charging has completed.

The headphones can be placed on the processor in any direction.

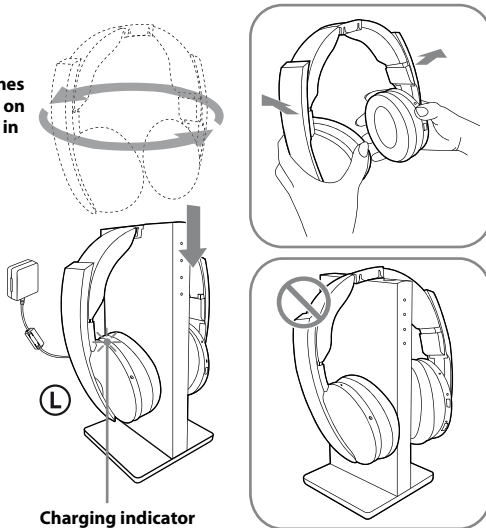

The headphones is not placed correctly.

Notes

- Check if the headphones are rested on the processor correctly.
- The indicator will not light up if the headphones' contact point does not meet the processor's contact pin. In this case, remove the headphones and place them on the processor again so that the indicator lights up.
- The processor automatically turns off while charging the battery.
- Charge in an environmental temperature of between 5°C and 35°C (between 41°F and 95°F). If the headphones is charged outside the recommended temperature range, the charging indicator flashes and charging stops. Otherwise, the battery may not be charged.
- Do not touch the contact pin of the processor. If a contact pin becomes dirty, charging may not be possible.
- Charging may not be completed if the processor's contact pin and headphones' contact point are dusty. Wipe them with a cotton bud, etc.

- If you do not use the headphones for a long period of time, the life of the rechargeable battery may become short. The life of the rechargeable battery improve when you repeat the charging and discharging process several times.
- The rechargeable Lithium-Ion battery should be replaced with a new one when it lasts only half the expected time, after a full charge has been performed. The rechargeable battery is not commercially available. The rechargeable battery is not intended to be replaced by the user, please contact your nearest Sony dealer for a new battery replacement.
- Do not store the headphones in hot places for a long period of time. Charge the battery once a year to prevent over discharge.
- Avoid exposure to extreme temperature, direct sunlight, moisture, sand, dust or mechanical shock.

Charging and usage time

Approx. charging time	Approx. usage time*1
3 hours*2	20 hours*3

*1 at 1 kHz, 1 mW + 1 mW output

*2 hours required to fully charge an empty battery

*3 Time may vary, depending on the temperature or conditions of use.

Checking the remaining battery power

To check the battery power, press and hold the POWER button about 2 seconds. The battery is still serviceable if the power indicator on the right housing lights up in green. Charge the rechargeable battery if the power indicator dims or flashes, or the sound becomes distorted or noisy.

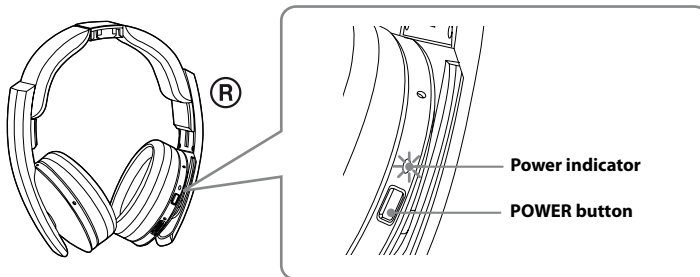

Connecting the Headphone System

Connecting the processor to digital components

Use the supplied optical digital connecting cable to connect the optical digital output jack on a BD/DVD device, digital satellite/TV receiver, GAME device or other digital component* to the DIGITAL IN jack of the processor.

The connected AV component may need to be set up for optical digital output. Refer to the operating instructions of the connected device.

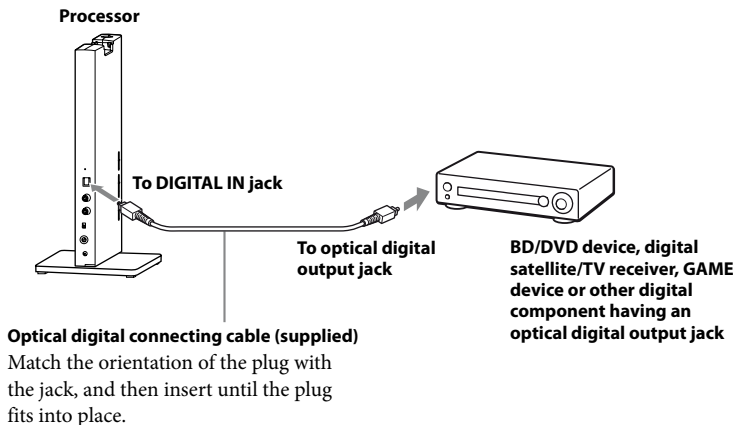

Notes

- The optical digital connecting cable is an extremely high-precision device and is sensitive to jolts and external pressure. Therefore, be careful when inserting and removing the cable plug.
- The digital input for the processor does not support sampling frequencies of 32 kHz/96 kHz. Set the digital output setting of the BD/DVD device to 48 kHz/44.1 kHz when using this system. Noise may be heard when a 32 kHz/96 kHz digital signal is input. If this happens, connect an audio cord to the LINE IN (L/R) jacks, and enjoy the audio via the analog input.

* Connection to the optical digital output jack on your personal computer is not guaranteed to work with this system.

DTS

- A DTS-compatible BD/DVD device is required for playback of BD/DVDs recorded in DTS audio. (For more details, refer to the operating instruction of your BD/DVD device.)
- When playing CDs recorded in DTS format, noise may occur when fast forwarding or rewinding. This is not a malfunction.
- If the DTS digital output is set to “OFF” on the BD/DVD device, no sound may be heard even if the DTS output is selected in the BD/DVD menu.

Notes on optical digital connecting cable

- Do not drop objects on the optical digital connecting cable or expose the cable to shock.
- Grasp the plug to connect or disconnect the cable.
- Be sure that the ends of the optical digital connecting cable are kept clean. Dust at the ends of the cable can degrade performance.
- When storing the system, attach the cap to the end of the plug and be careful not to fold or bend the optical digital connecting cable with a bend radius less than 25 mm (1 inch).

The bend radius of the optical digital connecting cable should be no less than 25 mm (1 inch).

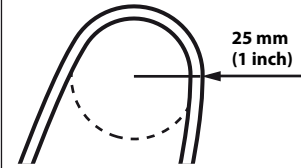

Connecting the processor to analog components

Use an audio cord (sold separately) to connect the audio output jacks on a VCR, TV, or other component to the LINE IN (L/R) jacks on the processor.

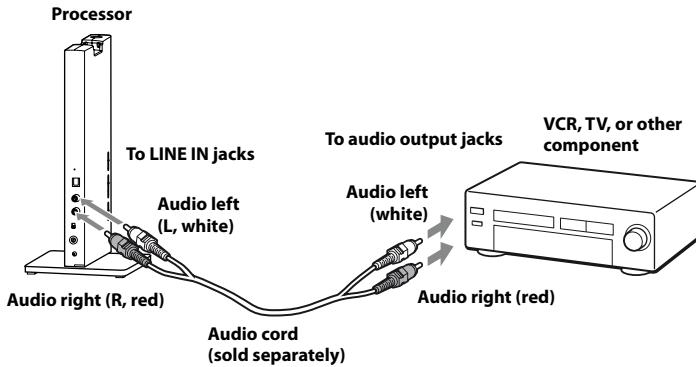

Connecting cables (sold separately)

Use the connecting cable (stereo mini-plug ↔ pin plug × 2) when connecting a stereo mini-jack (headphones jack, etc.) to the LINE IN jacks.

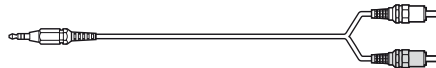

In this case, set the volume on the player at a medium level. Noise can occur if the volume on the player is set too low.

(Continued)

Setting the input level

If the volume is low using the analog input, set the ATT (attenuator) switch to “0 dB.”

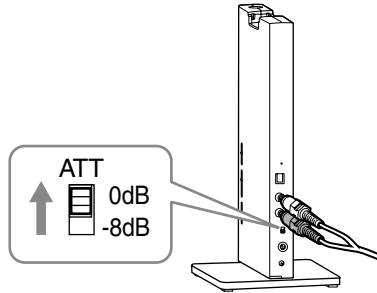

Setting	Connected components
0 dB	TV, portable components, and other components with a low output level
-8 dB	Other components (initial settings)

Notes

- Be sure to lower the volume before setting the ATT switch.
- If audio input to the LINE IN jacks is distorted (sometimes, noise can be heard at the same time), set the ATT switch to “-8 dB.”

Listening to a Connected Component

Before starting, be sure to read “Connecting the Headphone System” (pages 14 to 16) and make the proper connections.

- 1** Turn on the component connected to the processor.

BD/DVD device, digital satellite/
TV receiver, GAME device, or other
audio or video component

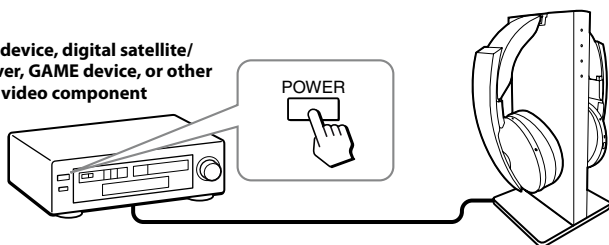

- 2** Remove the headphones from the processor.

The processor turns on automatically. The processor automatically detects the optimum frequency for transmission according to your room conditions. Then the Decode Mode indicator lights up, depending on the audio signal input from the connected audio or video component.

Signal transmission system

This unit employs a proprietary transmission system using 2.4 GHz frequency. You can enjoy non-compressed sound with this wireless system.

(Continued)

3 Put on the headphones.

Press the POWER button for 2 seconds to turn on the headphones, the power indicator lights up in green.

Be sure to match the right and left side of the headphones with your ears. Adjust the headphones band to fit your ears.

There is a tactile dot on the left housing to distinguish the left side.

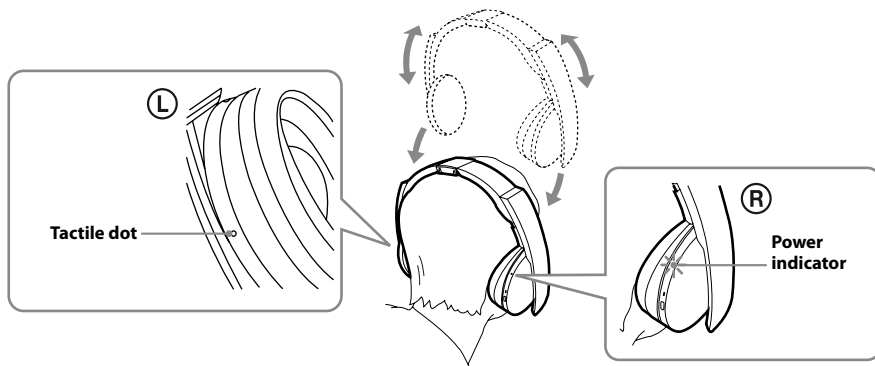

Note

Use the headphones within the signal transmission range (page 22).

4 Slide the INPUT switch to select the component you want to listen to.

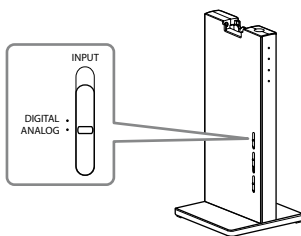

Position of switch	Selected sound source
DIGITAL	Sound of the component connected to DIGITAL IN jack.
ANALOG	Sound of the component connected to LINE IN jacks.

Note

To listen to dual audio (MAIN/SUB) sound sources, connect to the LINE IN jacks, and then select the sound source you want to listen to on the player, TV, or other component.

5 Start playback of the component selected in step 4.

6 Slide the switch to select the desired sound field, EFFECT or COMPRESSION.

EFFECT switch

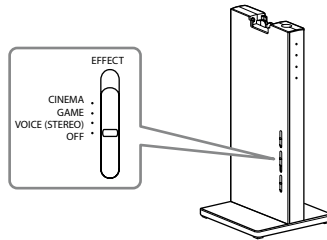

Position of switch	Sound field and suitable sound source
OFF	Normal playback of the headphones.
VOICE (STEREO)	Produces a clearer announcer's voice.
GAME	Creates an accurate spatial sound and provides a clear sense of direction. Produces powerful and realistic sound for multi-channel surround sound video games. Suitable for video games with multi-channel sound sources.
CINEMA	Provides a surround-sound environment with a more natural sound quality (particularly in dialog). Produces a high sound quality that is found in the latest movie theaters.

Notes

- The volume of the headphones may vary, depending on the input signal and the setting of the EFFECT switch.
- The surround sound effect may not be obtained from sound sources that do not incorporate video, such as music CDs.
- This system simulates the average HRTF* common to most people. However, the effect can differ from person to person since the HRTF can vary between individuals.

* Head Related Transfer Function

COMPRESSION switch

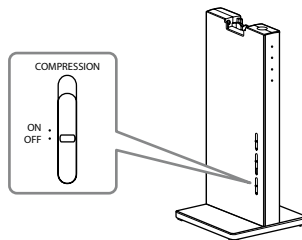

(Continued)

Position of switch	Playback Effect
OFF	When the EFFECT switch is selected, the sound mode changes to the selected effect.
ON	This function maintains the overall level of program material: explosive sounds are attenuated while lower level sounds (dialogue, etc.) are enhanced. Effective for audio signals with a wide dynamic range such as movies and classical music.

Illustration of the compression process

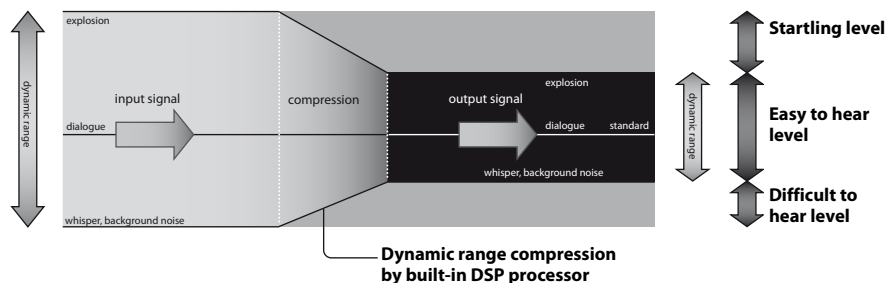

Decode Mode indicators

The processor automatically identifies the format of the input audio signal and the corresponding indicator lights up. Switch the audio between Dolby Digital, DTS, etc., on the connected equipment (BD/DVD device, digital satellite/TV receiver, etc.).

- Dolby Digital: Input signal recorded in the Dolby Digital format.
- Dolby PLIIx: Analog input signal, digital input PCM signal, or Dolby Digital signal processed by DOLBY PRO LOGIC IIx.
(If the EFFECT switch is set to “OFF” or “VOICE (STEREO),” it is not processed by DOLBY PRO LOGIC IIx.)
- DTS: Input signal recorded in the DTS format.

Note

If the equipment connected to the DIGITAL IN jack is not playing back (fast forwarding, rewinding, etc.), the Decode Mode indicators may not light up correctly.

7 Adjust the volume.

To raise the volume, turn the VOL (Volume) control towards the tactile dot, and vice versa.

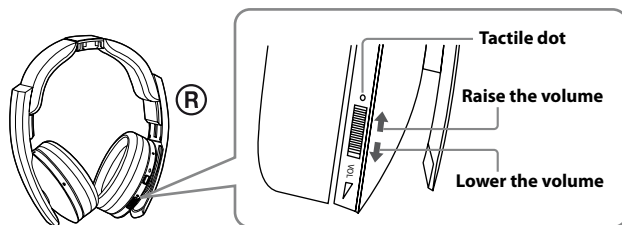

8 When you finished using the headphones, turn off the processor.

Press the **I** /  button on the processor to turn off the main power.

9 Place the headphones on the processor for charging.

Notes

- When watching films, be careful not to raise the volume too high in quiet scenes. You may hurt your ears when a loud scene is played.
- You may hear some noise when you disconnect the AC power adaptor from the processor before removing the headphones.

Transition time between modes

When sliding switches on the processor to change to new modes, the transition time between modes may vary. This is due to differences in system control between modes.

The power turns off automatically when you place the headphones on the processor

Charging will start automatically.

If a beep sound is heard from the headphones

A repeated beep sound is heard if the processor is not turned on or if the headphones are outside the RF signal transmission area. If you hear a beep sound, turn the processor on or move closer to the processor and use the headphones in the RF signal transmission area. If the beep sound does not stop even after turning the processor on or moving closer to the processor, the cause is likely to be interference from, for example, another wireless device using the 2.4 GHz wireless frequency band or electromagnetic waves generated from a microwave oven. Try taking the following measures.

- Place the processor away from a device that generates electromagnetic waves such as in a location in which a wireless LAN or other wireless device or microwave oven is used.
- Point the antenna of the headphones towards the antenna of the processor's direction, and make sure the signal is not blocked by any obstacles (page 22).
- Change the installation location or position of the antenna of the processor, and move to a location in which sound can be heard from the headphones.
- Install the processor outside of a rack, do not install it at the back of a rack.
- Install the processor in a location where no metal is present, do not install it on a metal table.
- Move the processor and headphones as close as possible to each other.

(Continued)

RF signal transmission area

- The approximate RF signal transmission area from the processor to the headphones is up to 100 m but it varies depending on whether obstacles (human body, metal, wall, etc.) are present and the reception conditions.
- The antennas of this system are built into the parts indicated by the dotted lines in the illustration below.

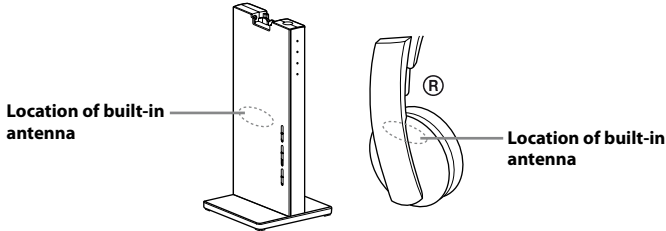

If there are any obstacles between the antenna part of the processor and the antenna part of the headphones, the signal transmission range may become shorter. In such a case, ensure no obstacles are between the antennas of the processor and headphones.

- The sound may be interrupted if you move out of the signal transmission range or the reception conditions around you deteriorate during use. The sound may also be interrupted as a result of obstacles, installation location or positioning of the processor and orientation of the headphones. This phenomenon is due to the characteristics of RF signals, and is not an indication of a malfunction.

Notes

- This system uses a signal in the 2.4 GHz frequency band so use under the following conditions may affect the signal transmission range.
 - An obstacle such as a human body, metal, or wall is between the processor and headphones.
 - The processor is installed at the back of a rack.
 - In a location in which a wireless LAN has been built, in a location in which a microwave oven is used nearby or other electromagnetic waves are generated, etc.
 - In a location in which another wireless device uses the 2.4 GHz frequency band.
- This system and a wireless LAN (IEEE802.11b/g) use the same frequency band (2.4 GHz) so use near a device incorporating a wireless LAN function will result in the generation of signal interference, which may cause the communication speed to deteriorate, and noise or sound interruption. In such a case, take the following measures.
 - When using the system within 10 m from a device incorporating a wireless LAN function, turn the wireless LAN function off.
 - Move the processor and headphones as close as possible to each other.
- Do not install the processor near metal objects such as on a metal table.
- The sound may be interrupted if the signal of this system is blocked by an obstacle. This phenomenon is due to the characteristics of RF signals, and is not an indication of a malfunction.

If an audio signal is not input for about 30 mins

RF signal transmission from the processor automatically stops when an audio signal is not input for about 30 minutes. When the transmission stops, the processor's power indicator blinks in green for 30 seconds and then turns off. RF signal transmission may stop when an extremely low sound is input for about 30 minutes. If this happens, raise the volume of the connected AV component as high as possible to the extent that the sound is not distorted and lower the volume of the headphones. If signal noise is output from a component connected to the AUDIO IN jacks, RF signal transmission may not stop.

If the processor is turned off

The headphones will be turned off automatically after 5 minutes. When you want to use the system again, turn the headphones and processor on.

If you move out from the signal transmission range, the headphones cannot be connected to the system, and will turn off automatically after 5 minutes.

Note

The processor only works with its supplied headphones.

Replacing the Ear Pads

The ear pads are replaceable. If the ear pads become dirty or worn out, replace them as illustrated below. The ear pads are not commercially available. You can order replacements from the store where you purchased this system, or at your nearest Sony dealer.

- 1 Remove the old ear pad by pulling it off.**

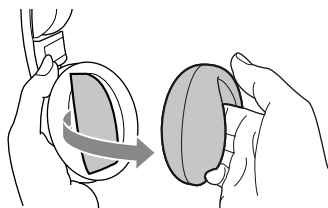

- 2 Place the new ear pad around the housing.**

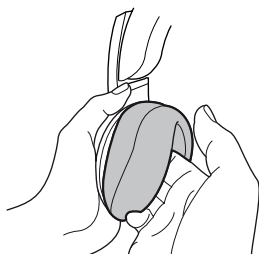

Troubleshooting

If you run into any problems using this headphone system, use the following checklist. Should any problem persist, consult your nearest Sony dealer.

Symptom	Cause and remedy
No sound	<ul style="list-style-type: none"> ➔ Check the connection between the processor and the AV component. ➔ Check that the connected AV component's optical digital output is set to "ON" when selecting digital input. ➔ Turn on the AV component connected to the processor, and start the playback. ➔ Turn on the processor and headphones. ➔ Check that the INPUT switch on the processor is set to the component you want to listen to. ➔ If you connect the processor to an AV component using the headphones jack, raise the volume level on the connected AV component as high as possible to the extent that the sound is not distorted. ➔ Raise the headphones volume. ➔ The headphones' power indicator goes off. <ul style="list-style-type: none"> • Charge the rechargeable battery if it is weak. If the power indicator is still off after charging the battery, take the headphones to your nearest Sony dealer. ➔ You are trying to play a DTS audio track on a BD/DVD device that does not support DTS. <ul style="list-style-type: none"> • Either use a BD/DVD device that supports DTS, or select a Dolby Digital or PCM audio track. ➔ You are playing back a BD/DVD disc recorded in DTS when DTS digital output setting for the BD/DVD device (including GAME device) is "OFF" <ul style="list-style-type: none"> • Refer to the operating instruction of your BD/DVD device, and change the DTS digital output setting to "ON." ➔ You are playing back a BD/DVD disc recorded in DTS when the BD/DVD device (including GAME device) and the processor are analog-connected. <ul style="list-style-type: none"> • Use the digital connection. (Analog sound may not be output from the BD/DVD device.) • Set the sampling frequency of output signals for the device connected to the processor to 48 kHz/44.1 kHz.

(Continued)

Symptom	Cause and remedy
Distorted or intermittent sound (sometimes with noise)	<ul style="list-style-type: none"> ➔ Charge the rechargeable battery if it is weak. If the power indicator is still off after charging the battery, take the headphones to a Sony dealer. ➔ Check if there is any wireless apparatus using 2.4 GHz frequency, or a microwave oven in the vicinity. ➔ Change the position of the processor. ➔ When analog input is selected, change the ATT switch on the processor to “-8 dB.” ➔ If you connect the processor to an AV component using the headphones jack, lower the volume level on the connected AV component. ➔ When using DTS audio sources, set the EFFECT switch on the processor to “CINEMA” or “GAME” or “VOICE (STEREO)” mode (page 19). ➔ Set the sampling frequency of the output signal of any component connected to the processor to 48 kHz/44.1 kHz.
Low sound	<ul style="list-style-type: none"> ➔ When analog input is selected, change the ATT switch on the processor to “0 dB.” ➔ If you connect the processor to an AV component using the headphones jack, raise the volume level on the connected AV component as high as possible to the extent that the sound is not distorted. ➔ Raise the headphones volume.
Loud background noise	<ul style="list-style-type: none"> ➔ If you connect the processor to an AV component using the headphones jack, raise the volume level on the connected AV component as high as possible to the extent that the sound is not distorted. ➔ Charge the rechargeable battery if it is weak. If the power indicator is still off after charging the battery, take the headphones to your nearest Sony dealer. ➔ Check if there is any wireless apparatus using 2.4 GHz frequency, or a microwave oven in the vicinity.
The sound cuts off (When using analog input)	<ul style="list-style-type: none"> ➔ The processor stop transmitting if no signal is input for about 30 minutes. <ul style="list-style-type: none"> • Set the ATT switch on the processor to “0 dB.” • If you connect the processor to an AV component using the headphones jack, raise the volume level on the connected AV component as high as possible to the extent that the sound is not distorted.
The surround sound effect is not obtained	<ul style="list-style-type: none"> ➔ Set the EFFECT switch on the processor to “CINEMA” or “GAME” mode (page 19). ➔ The audio being played is not a multi-channel signal. <ul style="list-style-type: none"> • The surround effect does not work for monaural sound sources.
The Dolby Digital indicator does not turn on	<ul style="list-style-type: none"> ➔ The digital audio output setting for the BD/DVD device (including GAME device) may be set to “PCM.” <ul style="list-style-type: none"> • Refer to the operating instruction of your BD/DVD device, and change the setting (such as “Dolby Digital/PCM” or “Dolby Digital”) for usage with components having built-in Dolby Digital decoders. ➔ Playback signals are not recorded in Dolby Digital format. ➔ The audio for the chapter being played is not a Dolby Digital signal.

Symptom	Cause and remedy
The Dolby PLIIx indicator does not turn on	<ul style="list-style-type: none"> ➔ The EFFECT switch on the processor is set to “OFF” or “VOICE (STEREO).” ➔ When the INPUT switch is set to DIGITAL, PCM signal or Dolby Digital signal is not input.
The Dolby PLIIx indicator turns on	<ul style="list-style-type: none"> ➔ The EFFECT switch on the processor is set to “CINEMA” or “GAME” mode. ➔ Analog input signal, digital input PCM signal, Dolby Digital signal is input.
The DTS indicator does not turn on	<ul style="list-style-type: none"> ➔ The DTS digital output setting on the BD/DVD device (including GAME device) is set to “OFF” <ul style="list-style-type: none"> • Refer to the operating instruction of your BD/DVD device, and change the DTS digital output setting to “ON.” ➔ Playback signals are not recorded in DTS format. ➔ The audio for the chapter being played is not a DTS signal. ➔ The BD/DVD device does not support DTS format. <ul style="list-style-type: none"> • Use a BD/DVD device that supports DTS.
The battery cannot be charged	<ul style="list-style-type: none"> ➔ Check if the charging indicator turns on. If not, put the headphones on the processor correctly so that the charging indicator turns on. ➔ The processor’s contact pin and headphones’ contact point are dusty. <ul style="list-style-type: none"> • Wipe them with a cotton bud, etc.
The charging indicator blinks.	<ul style="list-style-type: none"> ➔ The battery cannot be charged. <ul style="list-style-type: none"> • You are attempting to charge the battery in an environment outside the recommended temperature range of between 5°C and 35°C (between 41°F and 95°F). You cannot charge while the charging indicator flashes. • Charge in an environmental temperature of between 5°C and 35°C (between 41°F and 95°F).

(Continued)

Symptom**Cause and remedy**

Other devices (wireless LAN, cordless phone, etc.) using 2.4 GHz frequency around the processor become unusable

- ➔ If the wireless LAN uses the 2.4 GHz frequency, change the channel. If possible, use 5 GHz.
- ➔ Keep the processor more than 2 m away from other devices (wireless LAN, cordless phone, etc.) using the 2.4 GHz frequency.

The signal transmission range is short (sound is interrupted)

- ➔ If there is a device with a wireless LAN function, other wireless device, or a device that generates electromagnetic waves such as, for example, in a location where a microwave oven is used, use the system away from that device.
- ➔ Orient the antenna of the headphones toward the antenna of the processor, and make sure the signal is not blocked by an obstacle (page 22).
- ➔ Install the processor at a different location or position, or change the place in which you listen with the headphones.
- ➔ If the processor is installed at the back of a rack, install it outside of the rack.
- ➔ If the processor is installed on a metal table, install it in a location where no metal is present.
- ➔ Move the processor and headphones as close as possible to each other.

A repeated beep sounds

- ➔ The headphones cannot receive the signal from the processor.
 - Move within the RF signal transmission area.
 - Check the connection of the processor, AC power adaptor, and AC outlet.
 - Check if there is any wireless apparatus using 2.4 GHz frequency, or a microwave oven around the processor and headphones.
 - Change the position of the processor.
- ➔ There is no audio signal input for about 30 minutes and RF signals are not transmitted.

The unit does not operate properly

- ➔ Reset the unit. Pairing information is not deleted by this operation. Insert a small ball point pen, etc. into the hole, and push until you feel a click.

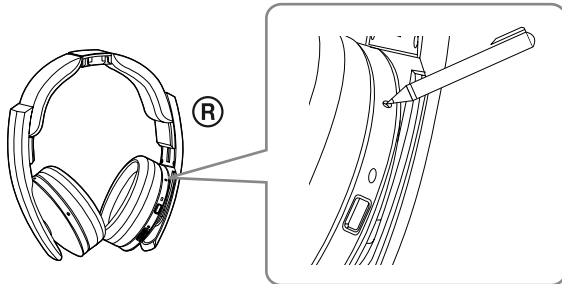

Precautions

On safety

- Do not drop, hit, or otherwise expose the processor or headphones to strong shock of any kind. This could damage the product.
- Do not disassemble or attempt to open any parts of the system.

On power sources and placement

- If you are not going to use the system for a long time, unplug the AC power adaptor from the AC outlet. When removing the plug, grip the AC power adaptor.
Do not pull on the cord.
- Do not place the system in any of the following locations.
 - Location exposed to direct sunlight, near a heater, or other extremely high-temperature location
 - Dusty location
 - On an unsteady or inclined surface
 - Location exposed to large amounts of vibration
 - Bathroom or other high-humidity locations

On headphones

Act considerately

When the volume is too high, the sound leaks outside the headphones. Be careful not to raise the volume so high that it bothers people around you. There is a tendency to raise the volume when using in noisy places. However, for reasons of safety, it is advised to keep the volume at a level whereby you can still hear sounds around you.

On cleaning

Use a soft cloth slightly moistened with mild detergent solution. Do not use solvents such as thinner, benzene or alcohol as these may damage the surface.

When the product breaks

- When the product breaks, or if a foreign object gets inside the unit, immediately turn off the power and consult your nearest Sony dealer.
- When taking the system to a Sony dealer, be sure to take both the headphones and processor.

Specifications

Digital surround processor (DP-RF6500)

Decoder functions	Dolby Digital Dolby Pro Logic IIx DTS DTS ES
Virtual surround function	OFF VOICE (STEREO) GAME CINEMA
Compression function	OFF ON
Modulation System	MSK
Operating frequency	2,400 MHz – 2,483.5 MHz
Maximum output power	< 20.0 dBm
Transmission distance	Approx. 100 m (328 ft) of longest*
Frequency response	12 Hz – 22,000 Hz (digital input)
Distortion rate	1% or less (1 kHz)
Audio inputs	Optical digital input (rectangular-type) × 1 Analog input (pin jack left/right) × 1
Power requirements	DC 6 V (800 mA) (from the supplied AC power adaptor)
Power consumption (rated)	2.0 W
Dimensions	Approx. 120 mm × 120 mm × 263 mm (4 3/4 in × 4 3/4 in × 10 3/8 in) (w/h/d)
Mass	Approx. 450 g (15.9 oz)
Operating temperature	5 °C to 35 °C (41 °F to 95 °F)

* The transmission distance is a rough estimate, and may vary depending on the surrounding environment and installation location.

Wireless stereo headphones (MDR-RF6500)

Operating frequency	2,400 MHz – 2,483.5 MHz
Maximum output power	< 20.0 dBm
Playback frequency range	12 Hz – 22,000 Hz (digital input)
Power requirements	Built-in Lithium-Ion rechargeable battery
Mass	Approx. 320 g (11.3 oz)
Operating temperature	5 °C to 35 °C (41 °F to 95 °F)

Supplied accessories

AC power adaptor (6 V) (1)
Optical digital connecting cable (optical rectangular plug ↔ optical rectangular plug, 1.5 m (59 1/8 in)) (1)
Operating Instructions (this manual) (1)
Connection Guide

Design and specifications are subject to change without notice.

<http://www.sony.net/>

Printed in Malaysia



* 4 2 6 7 2 6 3 1 3 * (2)