

Personal Audio System

ZS-S4iP

©2008 Sony Corporation Printed in China

Operating Instructions **GB**

<http://www.sony.net/>

WARNING

To reduce the risk of fire or electric shock, do not expose this apparatus to rain or moisture.

To reduce the risk of fire, do not cover the ventilation of the apparatus with newspapers, tablecloths, curtains, etc. And do not place lighted candles on the apparatus.

To reduce the risk of fire or electric shock, do not expose this apparatus to dripping or splashing, and do not place objects filled with liquids, such as vases, on the apparatus.

As the main plug is used to disconnect the unit from the mains, connect the unit to an easily accessible AC outlet. Should you notice an abnormality in the unit, disconnect the main plug from the AC outlet immediately.

Do not install the appliance in a confined space, such as a bookcase or built-in cabinet.

Do not expose the batteries (battery pack or batteries installed) to excessive heat such as sunshine, fire or the like for a long time.

Excessive sound pressure from earphones and headphones can cause hearing loss.



Disposal of Old Electrical & Electronic Equipment (Applicable in the European Union and other European countries with separate collection systems)

This symbol on the product or on its packaging indicates that this product shall not be treated as household waste. Instead it shall be handed over to the applicable collection point for the recycling of electrical and electronic equipment. By ensuring this product is disposed of correctly, you will help prevent potential negative consequences for the environment and human health, which could otherwise be caused by inappropriate waste handling of this product. The recycling of materials will help to conserve natural resources. For more detailed information about recycling of this product, please contact your local Civic Office, your household waste disposal service or the shop where you purchased the product. Accessory accessories: Remote control



Disposal of waste batteries (applicable in the European Union and other European countries with separate collection systems)

This symbol on the battery or on the packaging indicates that the battery provided with this product shall not be treated as household waste.

On certain batteries this symbol might be used in combination with a chemical symbol. The chemical symbols for mercury (Hg) or lead (Pb) are added if the battery contains more than 0.0005% mercury or 0.004% lead. By ensuring these batteries are disposed of correctly, you will help prevent potentially negative consequences for the environment and human health which could otherwise be caused by inappropriate waste handling of the battery. The recycling of the materials will help to conserve natural resources.

In case of products that for safety, performance or data integrity reasons require a permanent connection with an incorporated battery, this battery should be replaced by qualified service staff only. To ensure that the battery will be treated properly, hand over the product at end-of-life to the applicable collection point for the recycling of electrical and electronic equipment.

For all other batteries, please view the section on how to remove the battery from the product safely. Hand the battery over to the applicable collection point for the recycling of waste batteries.

For more detailed information about recycling of this product or battery, please contact your local Civic Office, your household waste disposal service or the shop where you purchased the product.

Notice for customers: the following information is only applicable to equipment sold in countries applying EU directives

The manufacturer of this product is Sony Corporation, 1-7-1 Konan, Minato-ku, Tokyo, 108-0075 Japan. The Authorized Representative for EMC and product safety is Sony Deutschland GmbH, Hedelfinger Strasse 61, 70327 Stuttgart, Germany. For any service or guarantee matters, please refer to the addresses given in separate service or guarantee documents.

Notes on DualDiscs

A DualDisc is a two sided disc product which mates DVD recorded material on one side with digital audio material on the other side. However, since the audio material side does not conform to the Compact Disc (CD) standard, playback on this product is not guaranteed.

Music discs encoded with copyright protection technologies

This product is designed to playback discs that conform to the Compact Disc (CD) standard. Recently, various music discs encoded with copyright protection technologies are marketed by some record companies. Please be aware that among those discs, there are some that do not conform to the CD standard and may not be playable by this product.

Precautions

Discs that this unit CAN play

- Audio CD
- CD-R/CD-RW (CD-DA*)
- * CD-DA is the abbreviation for Compact Disc Digital Audio. It is a recording standard used for Audio CDs.

Discs that this unit CANNOT play

- CD-R/CD-RW other than those recorded in music CD format
- CD-R/CD-RW of poor recording quality, CD-R/CD-RW that has scratches or are dirty, or CD-R/CD-RW recorded with an incompatible recording device
- CD-R/CD-RW which is finalized incorrectly

Notes on discs

- Before playing, clean the CD with a cleaning cloth. Wipe the CD from the center out. If there is a scratch, dirt or fingerprints on the CD, it may cause tracking errors.



- Do not use solvents such as benzene, thinner, commercially available cleaners or anti-static spray intended for vinyl LPs.
- Do not expose the CD to direct sunlight or heat sources such as hot air ducts, nor leave it in a car parked in direct sunlight, as there can be a considerable rise in temperature inside the car.
- Do not stick paper or stickers on the CD, nor scratch the surface of the CD.
- After playing, store the CD in its case.

On safety

- As the laser beam used in the CD player section is harmful to the eyes, do not attempt to disassemble the casing. Refer servicing to qualified personnel only.
- Should any solid object or liquid fall into the player, unplug the player, and have it checked by qualified personnel before operating it any further.
- Discs with non-standard shapes (e.g., heart, square, star) cannot be played on this player. Attempting to do so may damage the player. Do not use such discs.

On power sources

- For AC operation, use the supplied AC power cord; do not use any other type.
- The player is not disconnected from the AC power source (mains) as long as it is connected to the wall outlet, even if the player itself has been turned off.
- Unplug the player from the wall outlet when it is not to be used for an extended period of time.
- When the batteries are not to be used, remove them to avoid damage that can be caused by battery leakage or corrosion.
- The nameplate and important information concerning safety are located on the bottom exterior.

On placement

- Do not leave the player in a location near heat sources, in a place subject to direct sunlight, excessive dust, or mechanical shock, or in a car subject to the direct rays of the sun.
- Do not place the player on an inclined or unstable place.
- Do not place anything within 10 mm of the side of the cabinet. The ventilation holes must be unobstructed for the player to operate properly and prolong the life of its components.
- Since a strong magnet is used for the speakers, keep personal credit cards using magnetic coding or spring-wound watches away from the player to prevent possible damage from the magnet.

On operation

- If the player is brought directly from a cold to a warm location, or is placed in a very damp room, moisture may condense on the lens inside the CD player section. Should this occur, the player will not operate properly. In this case, remove the CD and wait about an hour for the moisture to evaporate.

Cleaning the cabinet

- Clean the cabinet, panel and controls with a soft cloth slightly moistened with a mild detergent solution. Do not use any type of abrasive pad, scouring powder, or solvent, such as alcohol or benzene.

If you have any questions or problems concerning your player, please consult your nearest Sony dealer.

Troubleshooting

General

The power is not on.

- Connect the AC power cord to the wall outlet securely.
- Make sure the batteries are inserted correctly.
- Replace all the batteries with new ones if they are weak.
- When you operate the unit on batteries, you cannot turn on the unit using OPERATE [1] on the remote.

There is no audio.

- Unplug the headphones when listening through speakers.

Noise is heard.

- Someone is using a portable telephone or other equipment that emits radio waves near the player. → Move the portable telephone, etc., away from the player.

iPod

There is no audio.

- Make sure the iPod is connected firmly.
- Adjust the VOLUME +, - [9].

Operation is impossible.

- Make sure the iPod is connected firmly.

Cannot charge iPod.

- You cannot charge the iPod when the unit is using DC power supply.
- You cannot charge the iPod when "DC OUT" does not appear on the display in radio mode.

CD player

The CD does not play or "no DISC" is displayed even when a CD is in place.

- Place the CD with the label surface up.
- Clean the CD.
- Take out the CD and leave the CD compartment open for about an hour to dry moisture condensation.
- The CD-R/CD-RW is blank.
- There is a problem with the quality of the CD-R/CD-RW, recording device or application software.
- Replace all the batteries with new ones if they are weak.

The sound drops out.

- Reduce the volume.
- Clean the CD, or replace it if the CD is badly damaged.
- Place the player in a location free from vibration.
- Clean the lens with a commercially available blower.
- The sound may drop out or noise may be heard when using poor quality CD-Rs/CD-RWs, or if there is a problem with the recording device or application software.

Radio

Reception is poor.

- Reorient the antenna to improve FM reception.

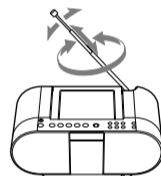

- Reorient the player itself to improve AM reception.

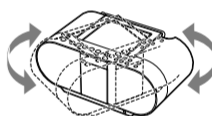

The audio is weak or has poor quality.

- Replace all the batteries with new ones if they are weak.
- Move the player away from the TV.

The picture of your TV becomes unstable.

- If you are listening to an FM program near the TV with an indoor antenna, move the player away from the TV.

Remote

The remote does not function.

- Replace all the batteries in the remote with new ones if they are weak.
- Make sure that you are pointing the remote at the remote sensor on the unit.
- Remove any obstacles in the path of the remote and the unit.
- Make sure the remote sensor is not exposed to strong light such as direct sunlight or fluorescent lamp light.
- Move closer to the unit when using the remote.

After trying the remedies, if you still have problems, unplug the AC power cord or remove all the batteries. After all the indications in the display disappear, plug the AC power cord in or insert the batteries again. If the problem persists, please consult your nearest Sony dealer.

Power sources

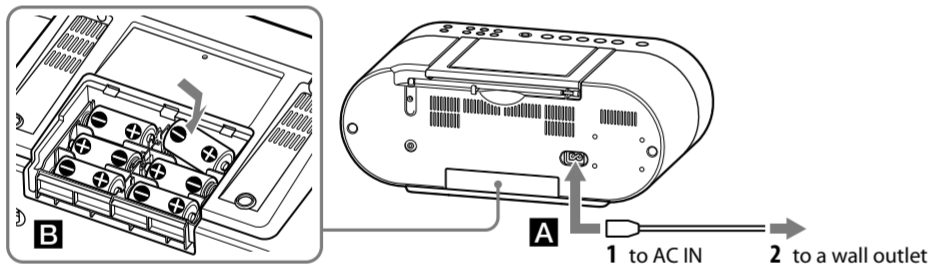

Connect the AC power cord **A** or insert six R14 (size C) batteries (not supplied) into the battery compartment **B**.

Notes

- Replace the batteries when the OPR/BATT indicator [1] dims or when the player stops operating. Replace all the batteries with new ones. Before you replace the batteries, be sure to remove the CD from the player.
- To use the player on battery power, disconnect the AC power cord from the player.

Preparing the remote

Insert two R6 (size AA) batteries (not supplied).

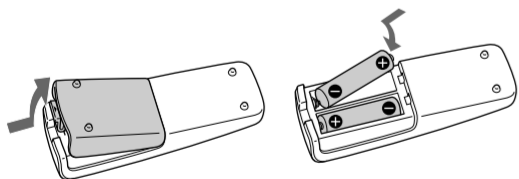

Replacing batteries

With normal use, the batteries for the remote should last about six months. When the remote no longer operates the unit, replace all the batteries with new ones.

Before using the unit

To turn on/off the power

Press OPERATE [1].

To adjust the volume

Press VOLUME +, - [9].

To listen through headphones

Connect the headphones to the (headphones) jack [2].

To reinforce the bass sound

Press MEGA BASS [16] on the remote. "MEGA BASS" appears in the display. To return to normal sound, press the button again.

Falling asleep to music

- 1 Play the music source you want.
- 2 Press SLEEP [19] on the remote to display "SLEEP"
- 3 Press SLEEP [19] on the remote to select the minutes until the player goes off automatically. Each time you press the button, the indication changes as follows: "60" → "90" → "120" → "OFF" → "10" → "20" → "30".

To cancel the sleep function

Press OPERATE [1] to turn off the power, or press SLEEP [19] repeatedly to set the sleep timer to "OFF" in step 3.

Specifications

CD player section

System
Compact disc digital audio system
Laser diode properties
Emission duration: Continuous
Laser output: Less than 44.6 μW
(This output is the value measurement at a distance of 200 mm from the objective lens surface on the optical pick-up block with 7 mm aperture.)
Number of channels
2
Frequency response
20 - 20,000 Hz +1/-2 dB
Wow and flutter
Below measurable limit

iPod section

DC out: 5V
MAX: 500mA
(AC only)

Radio section

Frequency range
FM: 87.5 - 108 MHz
AM: 531-1,611kHz (9kHz step)
530-1,610kHz (10kHz step)
IF
FM: 128 kHz
AM: 45 kHz
Antennas
FM: Telescopic antenna
AM: Built-in ferrite bar antenna

General

Speaker
Full range: 8 cm (3 1/4 inches) dia., 16 Ω, cone type (2)
Outputs
Headphones jack (stereo minijack):
For 16 - 32 Ω impedance headphones
Input
AUDIO IN jack (stereo minijack)
Power output
2 W + 2 W (at 16 Ω, 10% harmonic distortion)
Power requirements
For player:
230V AC, 50Hz
9 V DC, 6 R14 (size C) batteries
Power consumption
AC 16 W
Battery life
For player:
FM reception
Sony R14P: approx. 4 h
Sony alkaline LR14: approx. 16 h
CD playback
Sony R14P: approx. 2 h
Sony alkaline LR14: approx. 8 h

Dimensions
Approx. 400 × 169.7 × 224 mm (w/h/d)
(15 3/4 × 6 1/16 × 8 1/16 inches) (incl. projecting parts)
Mass
Approx. 3.4 kg (7 lb. 8 oz) (incl. batteries)
Supplied accessory
AC power cord (1)
Remote control (1)
Exchangeable lid (1)

Design and specifications are subject to change without notice.

Optional accessory

Sony MDR headphones series

Compatible iPod models

The compatible iPod models are as follows. Update your iPod to use the latest software before you use it.



iPod nano 5th generation (video camera)



iPhone 3GS



iPod touch 2nd generation



iPod nano 4th generation (video)



iPhone 3G



iPod touch 1st generation



iPod nano 3rd generation (video)



iPod classic



iPhone



iPod nano 2nd generation (aluminum)



iPod 5th generation (video)



iPod nano 1st generation



iPod 4th generation (color display)



iPod 4th generation



iPod mini

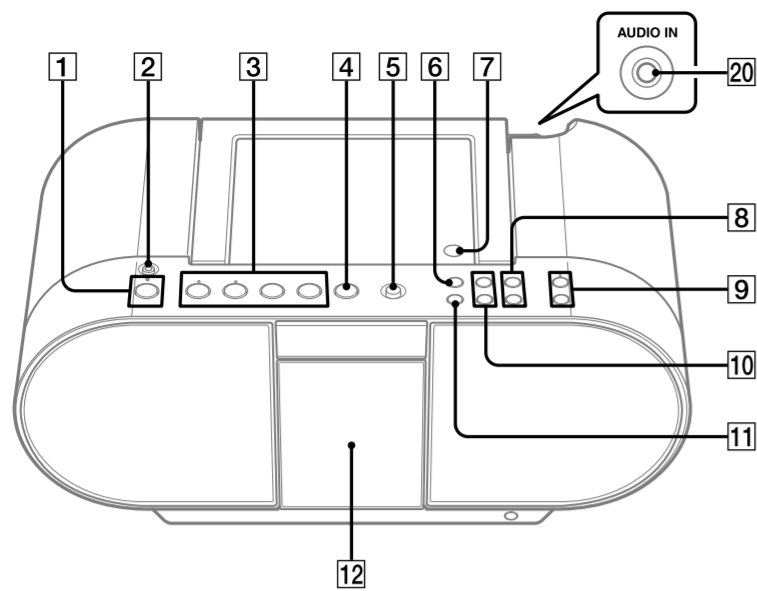

VOLUME + [9], iPod & iPhone [3] and CD [4] have a tactile dot.

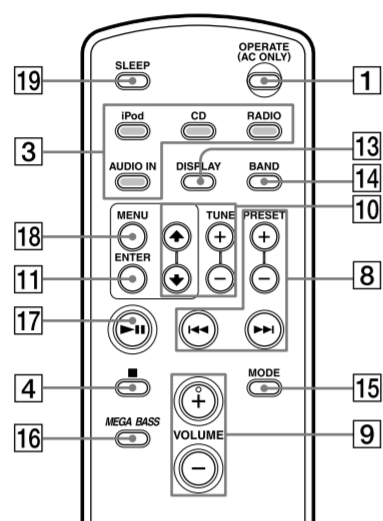

VOLUME + [9] has a tactile dot.

Loading an iPod

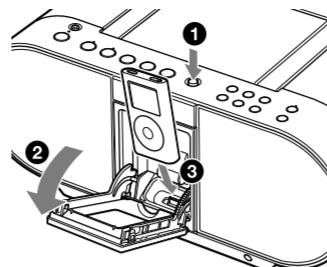

- 1 Press PUSH OPEN [5].
- 2 The door for the iPod is opened.
- 3 Insert your iPod onto the connector.

Close the door until it clicks.

Tips

- When using an iPod nano 1st generation/iPod nano 2nd generation (aluminum), you can adjust the position of the connector so that the iPod is placed in the middle.
- When using an iPod other than iPod nano 1st generation/iPod nano 2nd generation (aluminum), slide the connector to the right.

Notes

- When using the unit with AC, the unit will automatically turned on.
- When connecting an iPod during the playback, the unit continues the playback of the iPod even after the connection.

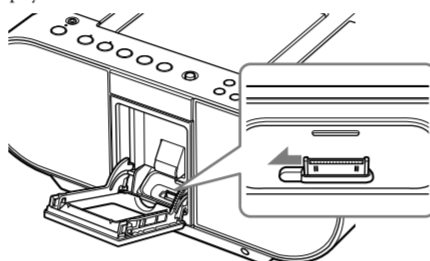

To change the cover

When using an iPod touch/iPhone, you can replace the cover with the exchangeable lid (supplied).

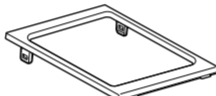

Exchangeable lid (supplied)

Remove the cover

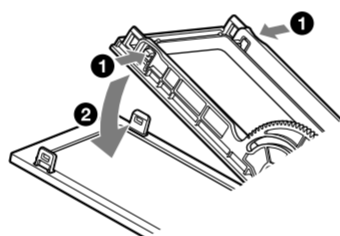

- 1 Press the latches on both sides of the door at the same time.
- 2 Remove the cover [12].

Shut the door until it clicks.

Insert the exchangeable lid

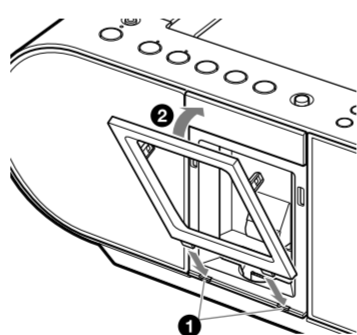

- 1 Insert the tabs of the exchangeable lid into the slots.
- 2 Push the upper part of the exchangeable lid into until it clicks into place.

Note

Confirm the latches are correctly engaged on both sides.

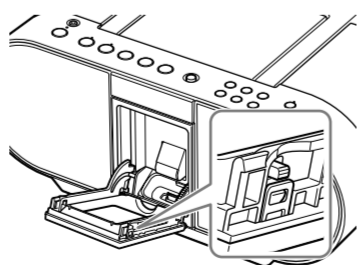

Playing an iPod

Press iPod & iPhone [3] (iPod [3] on the remote) and power turns on (direct power-on). "DC OUT" appears in the display (AC only) and the iPod begins to play automatically.

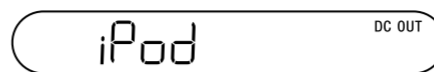

You can operate the connected iPod by the unit or the iPod buttons.

To	Press
Pause playback	iPod & iPhone [3] (iPod [3] on the remote). To resume play, press it again.
Stop playback	[4]
Go to the next track	[8]
Go back to the previous track	[8]
Locate a point while listening to the sound	[8] (forward) or [8] (backward) while playing and hold it until you find the point.
Locate a point while observing on the iPod display	[8] (forward) or [8] (backward) in pause and hold it until you find the point.
Select a menu	Press MENU/MODE [6] (MENU [6] on the remote) and [8] or [10] to select a menu, and then press ENTER [11].
Go back to the previous menu	Press MENU/MODE [6] (MENU [6] on the remote).

Notes

- You may use the universal adaptor supplied with your iPod for a more customized fit. The iPod may be docked without the use of an adaptor.
- If you connect the iPod when another function is in use, the function will change to iPod automatically.
- Apple's iPod Universal Dock Adapter (not supplied) can be used with this unit.
- To use an iPod, refer to the user's guide of your iPod.
- Before disconnecting the iPod, pause playback.

To use the unit as a battery charger (AC only)

You can use the unit as a battery charger. The charging status appears in the iPod display. For details, see the user's guide of your iPod.

On copyrights

- iPod is a trademark of Apple Inc., registered in the U.S. and other countries.
- iPhone is a trademark of Apple Inc.
- All other trademarks and registered trademarks are of their respective holders. In this manual, "™" and "®" marks are not specified.

Playing a CD

- 1 Press [7] and place a disc with the label side up in the CD compartment. To close the CD compartment, press [7].

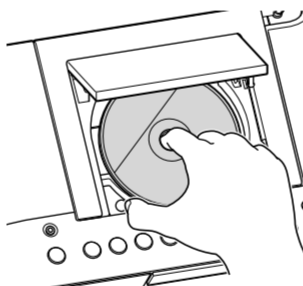

- 2 Press CD [3] (CD [3] on the remote). The player plays all the tracks once.



To	Press
Pause playback	CD [3] (CD [3] on the remote). To resume play, press it again.
Stop playback	[4]
Go to the next track	[8]
Go back to the previous track	[8]
Locate a point while listening to the sound	[8] (forward) or [8] (backward) while playing and hold it until you find the point.
Locate a point while observing the display	[8] (forward) or [8] (backward) in pause and hold it until you find the point.
Remove the CD	[7]

Selecting a CD play mode

Press MENU/MODE [6] (MODE [6] on the remote) until "P1", "SHUF", "SHUF" and "PGM", or "PGM" and "SHUF" appear in the display. Then proceed as follows:

To Select	Select	Then do this
Repeat a single track	[1]	Press [8] to select the track that you want to repeat, then press CD [3] (CD [3] on the remote).
Repeat all tracks	[2]	Press CD [3] (CD [3] on the remote).
Shuffle play	"SHUF"	Press CD [3] (CD [3] on the remote).
Repeat tracks in random order	"SHUF" and [2]	Press CD [3] (CD [3] on the remote).
Program play	"PGM"	Press [8] then press DISPLAY•ENTER [11] (ENTER [11] on the remote) for the tracks (up to 20) you want to program in the order you want. Then press CD [3] (CD [3] on the remote).



Repeat programmed tracks "PGM" and [2]. Press [8] then press DISPLAY•ENTER [11] (ENTER [11] on the remote) for the tracks (up to 20) you want to program in the order you want. Then press CD [3] (CD [3] on the remote).

To cancel the selected play mode

Press MENU/MODE [6] (MODE [6] on the remote) repeatedly until the selected mode disappears from the display.

To check the programmed track and playing order in the display

To check the order of tracks before playing, press DISPLAY•ENTER [11] (ENTER [11] on the remote). Every time you press the button, the track number appears in the programmed order.

To change the current program

Press [4] once if the CD is stopped and twice if the CD is playing. The current program will be erased. Then create a new program following the programming procedure.

Tip

You can play the same program again, since the program is saved until you open the CD compartment.

Listening to the radio

- 1 Press RADIO-BAND-AUTO PRESET [3] repeatedly (direct power-on) or press RADIO [3] and BAND [14] repeatedly on the remote. Each time you press the button, the indication changes as follows: "FM" ↔ "AM"

- 2 Hold down TUNE + or - [10] until the frequency digits begin to change in the display.

The player automatically scans the radio frequencies and stops when it finds a clear station.

If you can't tune in a station, press the button repeatedly to change the frequency step by step. When an FM stereo broadcast is received, "ST" appears.

Tips

- If the FM broadcast is noisy, press MENU/MODE [6] (MODE [6] on the remote) until "Mono" appears in the display and the radio will play in monaural.
- If you touch or operate an iPod connected to this unit while listening to AM/FM, noise may occur. Avoid touching or operating the iPod in this case.
- If you are listening to the radio with an iPhone connected to the unit, interference with radio reception may occur. Remove the iPhone in this case.
- If you hear noise from the AM/FM radio while supplying power to an iPod ("DC OUT" indicator appears in the display), press and hold MENU/MODE [6] (MODE [6] on the remote) for a few seconds to stop the power supply to the iPod ("DC OUT" indicator disappears from the display).

Changing the AM tuning interval

If you need to change the AM tuning interval, do the following:

- 1 While keeping the RADIO-BAND-AUTO PRESET [3] and MENU/MODE [6] pressed, disconnect the AC power cord from the wall outlet.

- 2 While keeping the RADIO-BAND-AUTO PRESET [3] and MENU/MODE [6] pressed, reconnect the AC power cord to the wall outlet.

The tuning interval is changed and "AM 9" or "AM 10" appears in the display for 4 seconds.

After changing the tuning interval, you need to reset your preset radio stations.

Presetting radio stations

You can store radio stations into the player's memory. You can preset up to 30 radio stations, 20 for FM and 10 for AM in any order.

- 1 Press RADIO-BAND-AUTO PRESET [3] (BAND [14] on the remote) to select the band.
- 2 Hold down RADIO-BAND-AUTO PRESET [3] (BAND [14] on the remote) for 2 seconds until "AUTO" flashes in the display.
- 3 Press DISPLAY•ENTER [11] (ENTER [11] on the remote). The stations are stored in memory from the lower frequencies to the higher ones automatically.

If a station cannot be preset automatically

You need to preset a station with a weak signal manually.

- 1 Press RADIO-BAND-AUTO PRESET [3] (BAND [14] on the remote) to select the band.
- 2 Tune in a station you want.
- 3 Hold down DISPLAY•ENTER [11] (ENTER [11] on the remote) for 2 seconds until the preset number flashes in the display.
- 4 Press PRESET + or - [8] until the preset number you want for the station flashes in the display.
- 5 Press DISPLAY•ENTER [11] (ENTER [11] on the remote). The new station replaces the old one.

Tip

The preset radio stations remain in memory even if you unplug the AC power cord or remove the batteries.

Playing preset radio stations

- 1 Press RADIO-BAND-AUTO PRESET [3] (BAND [14] on the remote) to select the band.
- 2 Press PRESET + or - [8] to tune in the stored station.

Using the display

iPod mode

To use iPod backlight

Press DISPLAY [13] on the remote.

CD mode

To check the total track number and playing time

In stop mode, press DISPLAY•ENTER [11] (DISPLAY [13] on the remote).

To check the remaining time

Press DISPLAY•ENTER [11] (DISPLAY [13] on the remote) repeatedly. The display changes as follows:

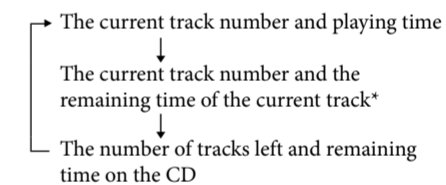

* For tracks numbered over 20, the remaining time appears as "-:--" in the display.

Radio mode

To display the frequency or a preset station number

Each time you press DISPLAY•ENTER [11] (DISPLAY [13] on the remote), the display changes to the frequency or a preset station number (if you have preset any).

Connecting optional components

You can enjoy the sound from an optional component such as a portable digital music player through the speakers of this unit. Be sure to turn off the power of each component before making any connections. For details, refer to the instruction manual of the component to be connected.

- 1 Connect the AUDIO IN jack [20] on the back of the unit to the line output jack of the portable digital music player or other components using an audio connecting cable (not supplied).
- 2 Turn the unit and the connected component on.
- 3 Press AUDIO IN [3] and start playing sound on the connected component.

The sound from the connected component is output from the speakers of this unit.

To connect the unit to a TV or VCR, use an extension cable (not supplied) with a stereo-mini jack on one end and two phono plugs on the other end.