

SONY[®]

4-247-583-14(1)

Home Theater System

Operating Instructions

HT-SL70

HT-SL65

HT-SL60

HT-SL55

HT-SL50

HT-SL40

—
© 2003 Sony Corporation

WARNING

To prevent fire or shock hazard, do not expose the unit to rain or moisture.

To prevent fire, do not cover the ventilation of the apparatus with newspapers, table-cloths, curtains, etc. And don't place lighted candles on the apparatus.

To prevent fire or shock hazard, do not place objects filled with liquids, such as vases, on the apparatus.



Don't throw away the battery with general house waste, dispose of it correctly as chemical waste.

Do not install the appliance in a confined space, such as a bookcase or built-in cabinet.

Except for customers in Europe



ENERGY STAR® is a U.S. registered mark.

As an ENERGY STAR® partner, Sony Corporation has determined that this product meets the ENERGY STAR® guidelines for energy efficiency.

This receiver incorporates Dolby* Digital and Pro Logic Surround and the DTS** Digital Surround System.

* Manufactured under license from Dolby Laboratories.

“Dolby”, “Pro Logic” and the double-D symbol are trademarks of Dolby Laboratories.

** “DTS” and “DTS Digital Surround” are registered trademarks of Digital Theater Systems, Inc.

Table of Contents

List of Button Location and Reference Pages

Main unit	5
-----------------	---

Hooking Up the Components

Required cords	6
Antenna hookups	7
Video component hookups	8
Digital component hookups	9
Other hookups	10

Hooking Up and Setting Up the Speaker System

Speaker system hookups	11
Performing initial setup operations	13
Multi channel surround setup	14
Checking the connections	19

Basic Operations

Selecting the component	19
-------------------------------	----

Enjoying Surround Sound

Decoding the input audio signal automatically (Auto Format Direct)	20
Enjoying stereo sound in multi channel (Dolby Pro Logic II)	20
Selecting a sound field	21
Understanding the multi channel surround displays	23
Customizing sound fields	24

Receiving Broadcasts

Storing FM stations automatically (AUTOBETICAL) ¹⁾	26
Direct tuning	26
Automatic tuning	27
Preset tuning	27
Using the Radio Data System (RDS) ¹⁾ ...	28

Other Operations

Using the Sleep Timer	30
Adjustments using the SET UP menu	30

Operations Using the Remote RM-U40

Before you use your remote	32
Remote button description	32
Changing the factory setting of an input selector button	36

Additional Information

Precautions	37
Troubleshooting	37
Specifications	40
Tables of settings using MAIN MENU button	43
Adjustable parameters for each sound field	back page

¹⁾ Models of are code CEL, CEK only.

About This Manual

The instruction in this manual are for models HT-SL70, HT-SL65, HT-SL60, HT-SL55, HT-SL50 and HT-SL40. Check your model number by looking at the lower right corner of the front panel. In this manual, the HT-SL50 is used for illustration purposes unless stated other wise. Any difference in operation is clearly indicated in the text, for example, “HT-SL50 only”.

The HT-SL70 consists of:

- Receiver STR-KSL50
- Speaker system
 - Front/surround speakers SS-SLP70
 - Center speakers SS-CNP70
 - Sub woofer SA-WMSP70

The HT-SL65 consists of:

- Receiver STR-KSL60
- Speaker system
 - Front/surround speakers SS-SLP70
 - Center speakers SS-CNP70
 - Sub woofer SA-WMSP70

The HT-SL60 consists of:

- Receiver STR-KSL60
- Speaker system
 - Front/surround speakers SS-MSP50
 - Center speakers SS-CNP50
 - Sub woofer SA-WMSP50

The HT-SL55 consists of:

- Receiver STR-KSL50
- Speaker system
 - Front/surround speakers SS-MSP55
 - Center speakers SS-CNP55
 - Sub woofer SA-WMSP50

The HT-SL50 consists of:

- Receiver STR-KSL50
- Speaker system
 - Front/surround speakers SS-MSP50
 - Center speakers SS-CNP50
 - Sub woofer SA-WMSP50

The HT-SL40 consists of:

- Receiver STR-KSL40
- Speaker system
 - Front/surround speakers SS-MSP50
 - Center speakers SS-CNP50
 - Sub woofer SA-WMSP40

About area codes

The area code of the receiver you purchased is shown on the lower portion of the rear panel (see the illustration below).

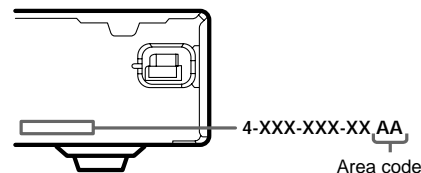

Any differences in operation, according to the area code, are clearly indicated in the text, for example, “Models of area code AA only”.

Tip

The instructions in this manual describe the controls on the remote. You can also use the controls on the receiver if they have the same or similar names as those on the remote. For details on the use of your remote, see pages 32 – 36.

Note for the supplied remote

RM-U40

The AUX and AAC BI-LING buttons on the remote are not available.

List of Button Locations and Reference Pages

How to use this page

Use this page to find the location of buttons that are mentioned in the text.

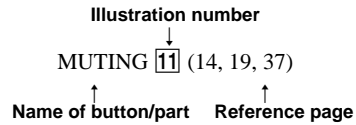

Main unit

HT-SL65 and HT-SL60 only

ALPHABETICAL ORDER

Display **6** (28)
 DVD (indicator) **3** (19)
 INPUT SELECTOR **9** (19, 26)
 IR (receptor) **7** (32)
 MASTER VOLUME **10** (18, 36)
 MUTING **11** (14, 19, 37)
 PRESET TUNING +/- **8** (28)
 SOUND FIELD **12** (21, 25, 38)
 TUNER (indicator) **5** (19)
 TV/SAT (indicator) **4** (19)
 VIDEO (indicator) **2** (19)

NUMBERS AND SYMBOLS

I/⏻ (power) **1** (13, 18, 19, 25, 26)
 PLII **13** (20)

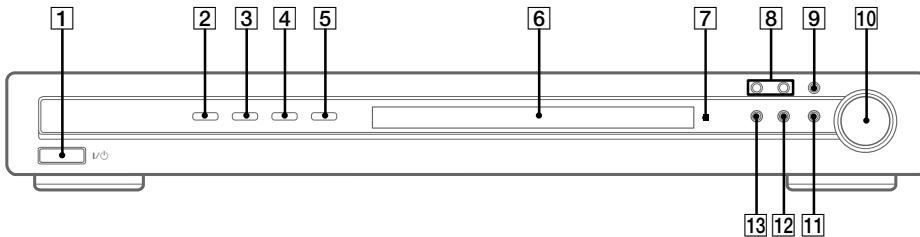

HT-SL70, HT-SL55, HT-SL50 and HT-SL40 only

ALPHABETICAL ORDER

Display **6** (28)
 DVD (indicator) **3** (19)
 INPUT SELECTOR **8** (19, 26)
 IR (receptor) **7** (32)
 MASTER VOLUME **9** (18, 36)
 MUTING **12** (14, 19, 37)
 PRESET TUNING +/- **13** (28)
 SOUND FIELD **11** (21, 25, 38)
 TUNER (indicator) **5** (19)
 TV/SAT (indicator) **4** (19)
 VIDEO (indicator) **2** (19)

NUMBERS AND SYMBOLS

I/⏻ (power) **1** (13, 18, 19, 25, 26)
 PLII **10** (20)

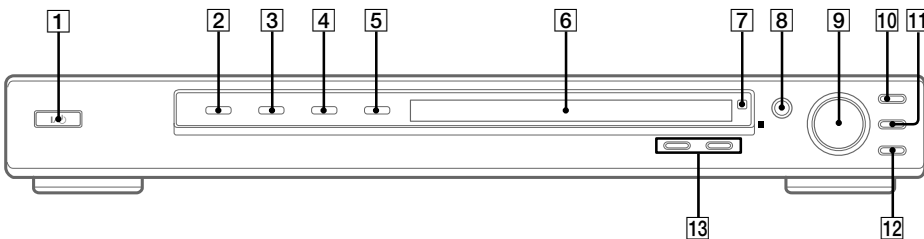

Hooking Up the Components

Required cords

The following optional connection cords **A** – **E** are required when you hook up the components (pages 8 – 9).

A Audio cord (not supplied)

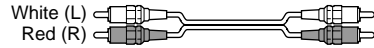

B Audio/Video cord (not supplied)

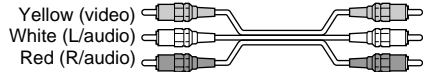

C Video cord (not supplied)

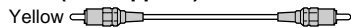

D Optical digital cord (not supplied)



E Coaxial digital cord (supplied)

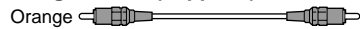

Before you get started

- Turn off the power to all components before making any connections.
- Do not connect the AC power cord until all of the connections are completed.
- Be sure to make connections firmly to avoid hum and noise.
- When connecting an audio/video cord, be sure to match the colour-coded pins to the appropriate jacks on the components: yellow (video) to yellow; white (left, audio) to white; and red (right, audio) to red.
- When connecting optical digital cords, insert the cord plugs straight in until they click into place.
- Do not bend or tie the optical digital cord.

Antenna hookups

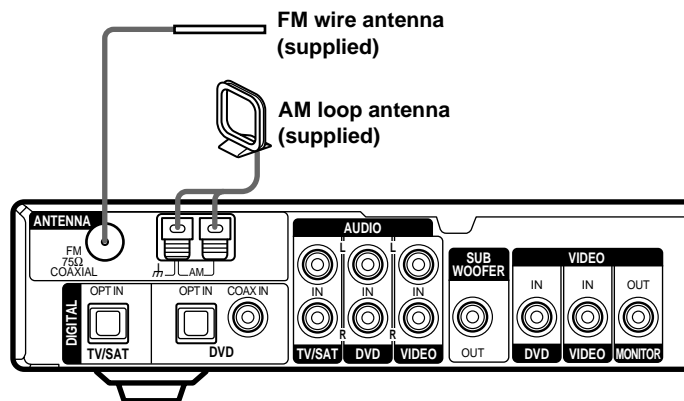

Notes on antenna hookups

- To prevent noise pickup, keep the AM loop antenna away from the receiver and other components.
- Be sure to fully extend the FM wire antenna.
- After connecting the FM wire antenna, keep it as horizontal as possible.

Video component hookups

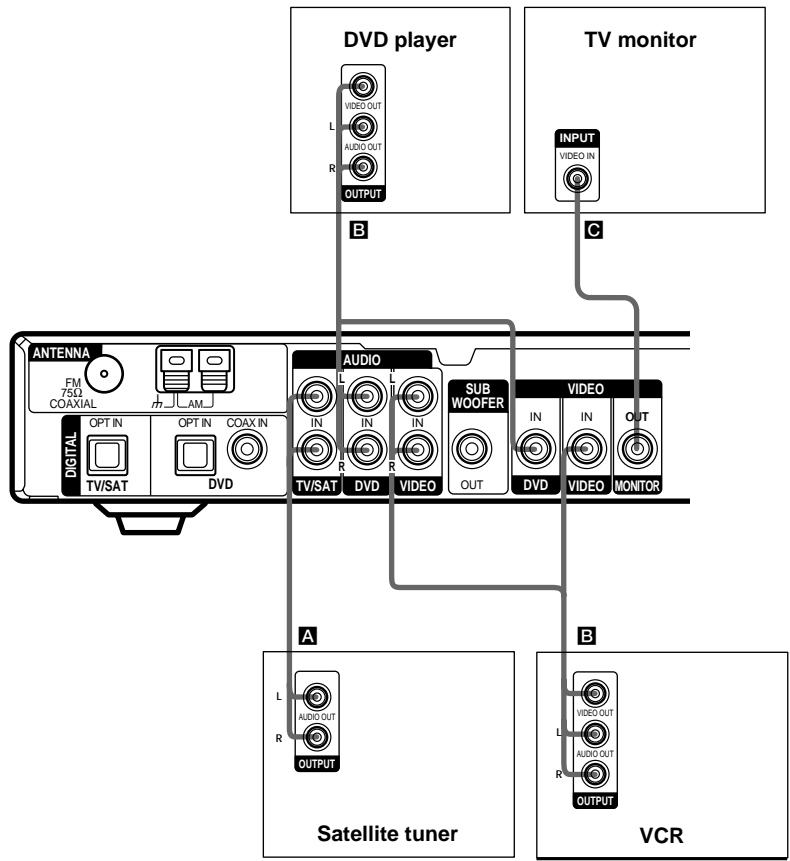

Digital component hookups

Connect the digital output jacks of your DVD player and satellite tuner (etc.) to the receiver's digital input jacks to bring the multi channel surround sound of a movie theater into your home. To fully enjoy multi channel surround sound, five speakers (two front speakers, two surround speakers, and a center speaker) and a sub woofer are required.

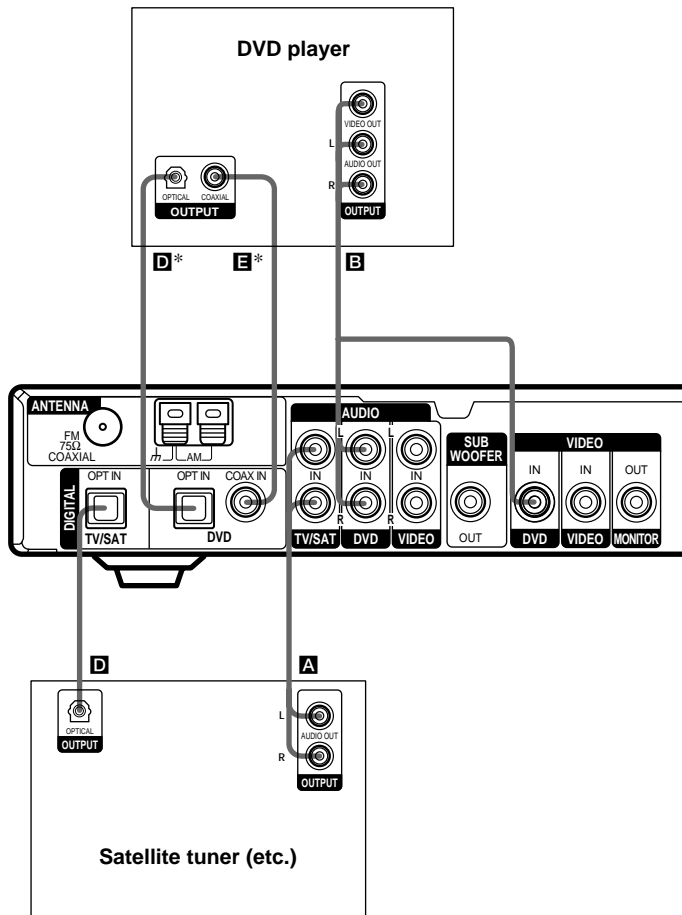

* Connect to either the COAX IN or OPT IN jack. We recommend making connections to the COAX IN jack.

Notes

- The OPT IN and COAX IN jacks are compatible with 96 kHz, 48 kHz, 44.1 kHz and 32 kHz sampling frequencies.
- To playback the multi channel surround sound through this receiver, you may have to change the digital output setting on the connected component. For details, refer to the operating instructions supplied with the component.

Other hookups

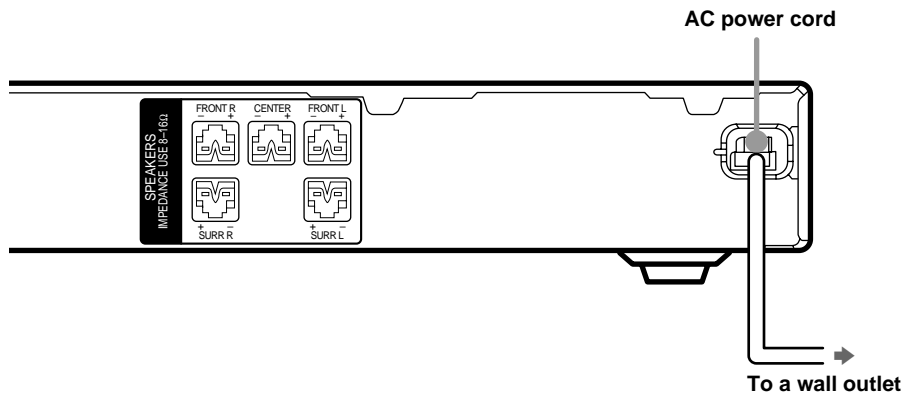

Connecting the AC power cord

Before connecting the AC power cord of this receiver to a wall outlet, connect the speaker system to the receiver (see page 11).

Connect the AC power cord(s) of your audio/video components to a wall outlet.

Hooking Up and Setting Up the Speaker System

Speaker system hookups

Before connecting speakers, be sure to turn off this unit.

Required cords

A Speaker cords (supplied)

The connector and the colour tube of the speaker cords are the same colour as the speaker terminal to be connected.



B Monaural audio cord (supplied)

Black

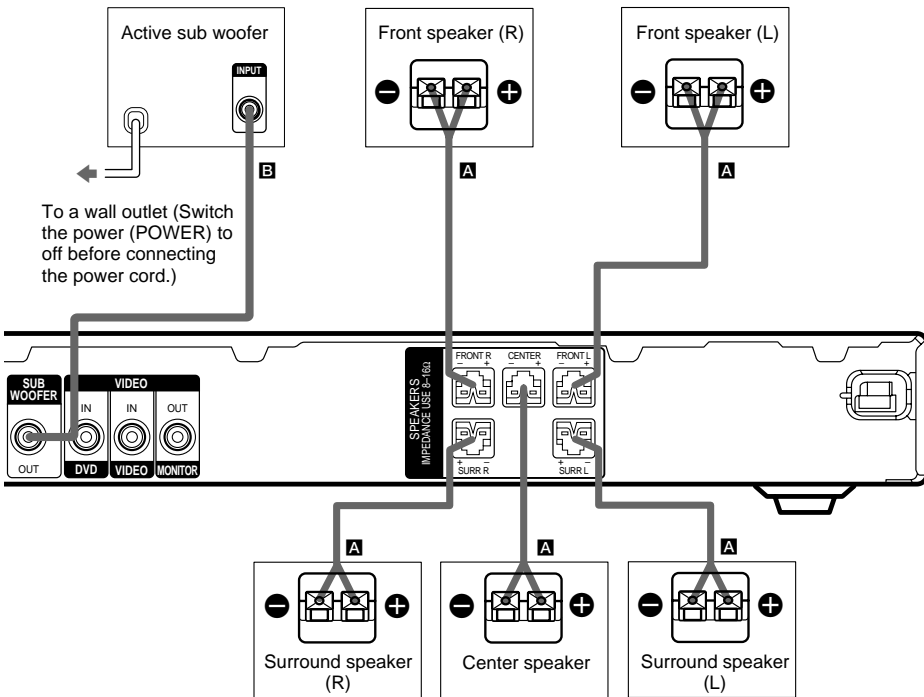

Tip
HT-SL60, HT-SL55, HT-SL50 and HT-SL40 only
To prevent speaker vibration or movement while listening, attach the supplied foot pads at the bottom of the speakers.

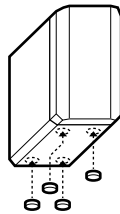

Note
Attach the colour labels onto the speakers so that you can identify the speakers to be connected.

continued

Hooking Up and Setting Up the Speaker System

Speaker system hookups (continued)

To change the speaker cord

If you want to change the speaker cord, you can detach the supplied speaker cord from the connector.

- 1 Press the connector onto a flat surface.**
Make sure that the catcher is at the bottom.

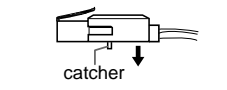

- 2 Pull the speaker cord from the connector.**

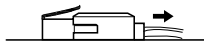

- 3 Twist the stripped ends of the speaker cord you want about 10 mm and insert the speaker cord into the connector.**

Make sure that the speaker cord is inserted according to its polarity : + to + and – to –. Otherwise the sound will be distorted and will lack bass.

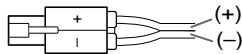

- 4 Remove the connector from the flat surface.**

Notes

- Connect the long speaker connecting cords to the surround speaker terminals and the short speaker connecting cords to the front and center speaker terminals.
- To avoid the speaker cord from coming off the speaker connector
 - do not use a smaller-sized speaker cord. We recommend that you use the AWG24 to AWG18 speaker cord size.
 - use the same speaker cord size for all the speaker connectors.
 - twist the stripped ends of the speaker cords.
 - insert the speaker cord securely to the back of the speaker connector.

To avoid short-circuiting the speakers

Short-circuiting of the speakers may damage the receiver. To prevent this, make sure to take the following precautions when connecting the speakers.

Make sure the stripped ends of each speaker cord does not touch another speaker terminal, the stripped end of another speaker cord, or the metal parts of the speaker.

Examples of poor conditions of the speaker cord

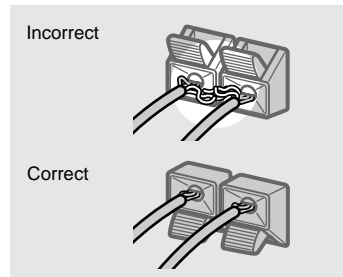

Stripped speaker cord is touching another speaker terminal.

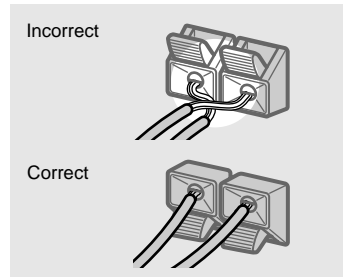

Stripped cords are touching each other due to excessive removal of insulation.

After connecting all the components, speakers, and AC power cord, output a test tone to check that all the speakers are connected correctly. For details on outputting a test tone, see page 18.

If no sound is heard from a speaker while outputting a test tone or a test tone is output from a speaker other than the one whose name is currently displayed on the receiver, the speaker may be short-circuited. If this happens, check the speaker connection again.

To avoid damaging your speakers

Make sure that you turn down the volume before you turn off the receiver. When you turn on the receiver, the volume remains at the level you turn off the receiver.

Performing initial setup operations

Once you have hooked up the speakers and turned on the power, clear the receiver's memory. Then specify the speaker parameters (size, position, etc.) and perform any other initial setup operations necessary for your system.

Tip

To check the audio output during settings (to set up while outputting the sound), check the connection (see page 19).

Clearing the receiver's memory

Before using your receiver for the first time, or when you want to clear the receiver's memory, do the following.

1 Press I/⏻ to turn off the receiver.

2 Hold down I/⏻ on the receiver for 5 seconds.

“INITIAL” appears in the display.

The following are reset to their factory settings.

- All settings in the SET UP, LEVEL and TONE menus.
- All sound field parameters.
- All preset stations.
- The sound fields memorized for each INPUT SELECTOR and preset stations.
- The master volume is set to “VOL MIN”.

Performing initial setup operations

Before using your receiver for the first time, adjust MAIN MENU parameters so that the receiver correspond to your system. For the adjustable parameters, see the table on page 43. See pages 14–18 for speaker settings and pages 30–31 for other settings.

Multi channel surround setup

For the best possible surround sound, all speakers should be the same distance from the listening position (A).

However, the receiver lets you to place the center speaker up to 1.5 meters closer (B) and the surround speakers up to 4.5 meters closer (C) to the listening position.

The front speakers can be placed from 1.0 to 7.0 meters from the listening position (A).

You can place the surround speakers either behind you or to the side, depending on the shape of your room (etc.).

However, we recommend that you place the surround speakers behind you.

When placing surround speakers to your side (long room)

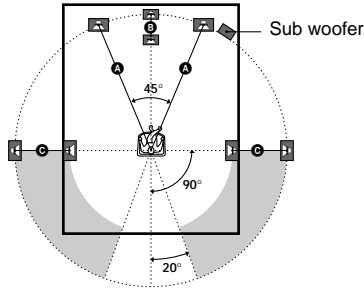

When placing surround speakers behind you (wide room)

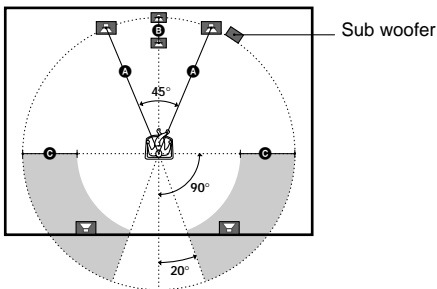

Note

Do not place the center speaker farther away from the listening position than the front speakers.

Normal Speaker and Micro Satellite Speaker

For HT-SL70, HT-SL65, HT-SL60, HT-SL55, HT-SL50 and HT-SL40, the speaker size and the sub woofer selection has been preset to "MICRO SP." (Micro Satellite Speaker) according to the supplied speaker system.

When you select "MICRO SP.", the speaker size and sub woofer selection has been configured as follows:

Speaker	Settings
FRONT	SMALL
CENTER	SMALL
SURROUND	SMALL
SUB WOOFER	YES

You cannot change the configuration if you select "MICRO SP."

If you change the speaker system, select "NORM. SP.". You can adjust the speaker size and sub woofer selection when you select "NORM. SP." (page 17).

To select "NORM. SP.", turn off the power. Then, hold down MUTING on the receiver and press I/⏻ on the receiver to turn on the power. (To reset to "MICRO SP.", do the same procedure).

Tip

The setting for Micro Satellite Speakers (MICRO SP.) has been programmed to optimize the sound balance. If you use Sony's Micro Satellite Speakers, select "MICRO SP."

Caution

- When you use Micro Satellite Speakers and the speaker size is set to "LARGE", you may not obtain the correct soundstage. The speaker may also be damaged at high volume position.
- If you use normal speakers with low maximum input rating, adjust the volume carefully to avoid excessive output on the speakers.

Specifying the speaker parameters

- 1 Press **MAIN MENU** repeatedly to select the “<SET UP>”.
- 2 Press **↑** or **↓** to select the parameter you want to adjust.
- 3 Press **←** or **→** to select the setting you want.
The setting is entered automatically.
- 4 Repeat steps 2 to 3 until you have set all of the parameters that follow.

Initial settings

Parameter	Initial setting
DIST. X.X m	3.0 m
DIST. X.X m	3.0 m
DIST. X.X m	3.0 m
PL. XXXX	LOW

■ Front speaker distance

DIST. X.X m

Set the distance from your listening position to the front speakers (A on page 14).

■ Center speaker distance

DIST. X.X m

Set the distance from your listening position to the center speaker. Center speaker distance should be set from a distance equal to the front speaker distance (A on page 14) to a distance 1.5 meters closer to your listening position (B on page 14).

■ Surround speaker distance

DIST. X.X m

Set the distance from your listening position to the surround speakers. Surround speaker distance should be set from a distance equal to the front speaker distance (A on page 14) to a distance 4.5 meters closer to your listening position (C on page 14).

Tip

The receiver allows you to input the speaker position in terms of distance. However, it is not possible to set the center speaker further than the front speakers. Also, the center speaker cannot be set more than 1.5 meters closer than the front speakers.

Likewise, the surround speakers can not be set further away from the listening position than the front speakers. And they can be no more than 4.5 meters closer.

This is because incorrect speaker placement is not conducive to enjoy surround sound.

Please note that, setting the speaker distance closer than the actual location of the speakers will cause a delay in the output of the sound from that speaker. In other words, the speaker will sound like it is further away.

For example, setting the center speaker distance 1–2 m closer than the actual speaker position will create a fairly realistic sensation of being “inside” the screen. If you cannot obtain a satisfactory surround effect because the surround speakers are too close, setting the surround speaker distance closer (shorter) than the actual distance will create a larger sound stage.

Adjusting these parameter while listening to the sound often results in much better surround sound. Give it a try!

continued

Multi channel surround setup (continued)



■ Surround speaker placement

(  PL. XXXX)*

This parameter lets you specify the height of your surround speakers for proper implementation of the Digital Cinema Sound surround modes. Refer to the illustration below.

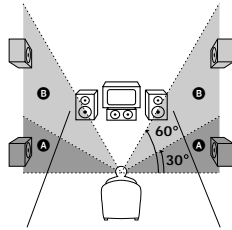
- Select “PL. LOW” if the location of your surround speakers corresponds to section **A**.
- Select “PL. HIGH” if the location of your surround speakers corresponds to section **B**.



* These parameters are not available when “Surround speaker size   ” is set to “NO”.

Tip

The surround speaker placement parameter is designed specifically for implementation of the Digital Cinema Sound modes with virtual elements. With the Digital Cinema Sound modes, speaker placement is not as critical as other modes. All modes with virtual elements were designed under the premise that the surround speaker would be located behind the listening position, but presentation remains fairly consistent even with the surround speakers positioned at a rather wide angle. However, if the speakers are pointing towards the listener from the immediate left and right of the listening position, the sound fields with virtual elements will not be as effective.

Nevertheless, each listening environment has many variables, like wall reflections.

Therefore, we recommend that you playback multi channel surround encoded software and listen to the effect each setting has on your listening environment. Choose the setting that provides a good sense of spaciousness and that best succeeds in forming a cohesive space between the surround sound from the surround speakers and the sound of the front speakers. If you are not sure which sounds best, select “PL. LOW” and then use the speaker distance parameter and speaker level adjustments to obtain proper balance.

Only when you use the speaker system other than the supplied one, be sure to set the following parameters.

For details on “NORM. SP.” (Normal Speaker), see page 14.

■ Sub woofer selection (S.W. XXX)



- If you connect a sub woofer, select “YES”.
- If you do not connect a sub woofer, select “NO”. This activates the bass redirection circuitry and outputs the LFE signals from other speakers.

■ **Front speaker size** (  XXXXX)

- If you connect large speakers that will effectively reproduce bass frequencies, select “LARGE”. Normally select “LARGE”.
- If the sound is distorted, or you feel a lack of surround effects when using multi channel surround sound, select “SMALL” to activate the bass redirection circuitry and output the front channel bass frequencies from the sub woofer.
- When the front speakers are set to “SMALL”, the center and surround speakers are also automatically set to “SMALL” (unless previously set to “NO”).
- When the sub woofer is set to “NO”, the front speakers are automatically set to “LARGE” and you cannot change the setting.

■ **Center speaker size** ( XXXXX)

- If you connect a large speaker that will effectively reproduce bass frequencies, select “LARGE”. Normally select “LARGE”. However, if the front speakers are set to “SMALL”, you cannot set the center speaker to “LARGE”.
- If the sound is distorted, or you feel a lack of surround effects when using multi channel surround sound, select “SMALL” to activate the bass redirection circuitry and output the center channel bass frequencies from the front speakers (if set to “LARGE”) or sub woofer.*1
- If you do not connect a center speaker, select “NO”. The sound of the center channel will be output from the front speakers.*2

■ **Surround speaker size** (  XXXXX)

- If you connect large speakers that will effectively reproduce bass frequencies, select “LARGE”. Normally select “LARGE”. However, if the front speakers are set to “SMALL”, you cannot set the surround speakers to “LARGE”.
- If the sound is distorted, or you feel a lack of surround effects when using multi channel surround sound, select “SMALL” to activate the bass redirection circuitry and output the surround channel bass frequencies from the sub woofer or other “LARGE” speakers.
- If you do not connect surround speakers, select “NO”.*3

Tip

*1-#3 correspond to the following Dolby Pro Logic modes

- *1 NORMAL
- *2 PHANTOM
- *3 3 STEREO

Tip

Internally, the LARGE and SMALL settings for each speaker determine whether or not the internal sound processor will cut the bass signal from that channel. When the bass is cut from a channel, the bass redirection circuitry sends the corresponding bass frequencies to the sub woofer or other “LARGE” speakers.

However, since bass sounds have a certain amount of directionality, it best not to cut them, if possible. Therefore, even when using small speakers, you can set them to “LARGE” if you want to output the bass frequencies from that speaker. On the other hand, if you are using a large speaker, but prefer not to have bass frequencies output from that speaker, set it to “SMALL”.

If the overall sound level is lower than you prefer, set all speakers to “LARGE”. If there is not enough bass, you can use the BASS parameter in the TONE menu to boost the bass levels. To adjust the bass, see page 25.

continued

Multi channel surround setup (continued)

Adjusting the speaker level

Use the remote while seated in your listening position to adjust the level of each speaker.

Note

The receiver incorporates a new test tone with a frequency centered at 800 Hz for easier speaker level adjustment.

- 1 Press **I/⏻** to turn on the receiver.
- 2 Press **TEST TONE**.
“T. TONE” appears in the display and you will hear the test tone from each speaker in sequence.
Front (left) → Center → Front (right) → Surround (right) → Surround (left) → Sub woofer
- 3 **Adjust the speaker level and balance using the LEVEL menu so that the level of the test tone sounds the same from each speaker.**
For details on the LEVEL menu, see page 24.
While adjusting, the test tone is output from the speaker whose adjustment is performed.
- 4 Press **TEST TONE** again to turn off the test tone.

Tip

You can adjust the level of all speakers at the same time. Press **MASTER VOL +/-** on the remote or turn **MASTER VOLUME** on the receiver.

Note

The adjusted value are shown in the display during adjustment.

Listening to the sub woofer

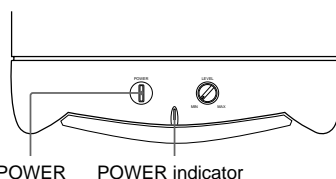

First, turn down the volume on the receiver. The volume should be set to minimum before you begin playing the program source.

- 1 Turn on the receiver and select the program source.
- 2 Press **POWER** on the sub woofer.
The POWER indicator on the sub woofer lights up in green.
- 3 Play the program source.

Adjusting the sound

Slight adjustments to the system can enhance your sound enjoyment.

Adjusting the sub woofer

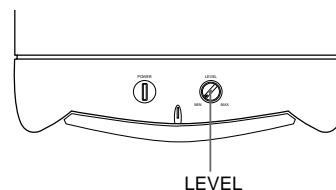

- 1 Rotate **LEVEL** to adjust the volume.
Set the volume level to best suit your preference according to the program source.

Note

Do not turn the volume of the woofer to maximum. Extraneous noise may be heard.

Checking the connections

After connecting all of your components to the receiver, do the following to verify that the connections were made correctly.

- 1 Press **I/⏻** to turn on the receiver.
- 2 Turn on the component that you connected (e.g., DVD player or VCR).
- 3 Press the input selector button (e.g., DVD or VIDEO) to select the component (program source).
- 4 Start playing.

If you do not obtain normal sound output after performing this procedure, see “Troubleshooting” on page 37 and take the appropriate measures to correct the problem.

Tip

You can also use INPUT SELECTOR on the receiver to select the component.

Selecting the component

INPUT SELECTOR

Press INPUT SELECTOR repeatedly to select the component you want to use.

To select	Display/light up
VCR	VIDEO
DVD player	DVD
Satellite tuner	TV/SAT
Built in tuner	TUNER

After turning on the component you selected, select the component and play the program source.

- After selecting VCR or DVD player, turn on the TV and set the TV’s video input to match the component you selected.

MUTING

Press MUTING to mute the sound. “MUTING” appears on the display when the sound is muted. To cancel muting, press it again or turn up the volume.

The muting function is also canceled when you turn the power off, or disconnect the power cord.

Enjoying Surround Sound

You can take advantage of surround sound simply by selecting one of the receiver's pre-programmed sound fields. They bring the exciting and powerful sound of movie theaters and concert halls into your home. You can also customize the sound fields to obtain the sound you want by changing the surround parameter. To fully enjoy surround sound, you must register the number and location of your speakers. See "Multi channel surround setup" starting from page 14 to set the speaker parameters before enjoying surround sound.

Decoding the input audio signal automatically (Auto Format Direct)

Press A.F.D.

"A.F.D. AUTO" appears in the display.

This mode automatically detects the type of audio signal being input (Dolby Digital, DTS, or standard 2 channel stereo) and performs the proper decoding if necessary. This mode presents the sound as it was recorded/encoded, without adding any effects (e.g. reverberation).

However, if there are no low frequency signals (Dolby Digital LFE, etc.) it will generate a low frequency signal for output to the sub woofer.

Enjoying stereo sound in multi channel (Dolby Pro Logic II)

This function lets you specify the type of decoding for 2 channel audio sources.

This receiver can reproduce 2 channel sound in 5 channels through Dolby Pro Logic II; or 4 channels through Dolby Pro Logic.

Press **□□PL/PLII** repeatedly to select "DOLBY PL", "PLII MOV" or "PLII MUS".

The selected mode appears in the display.

■ DOLBY PL (Dolby Pro Logic)

Performs the Pro Logic decoding. Software with multi channel surround audio signals is played back according to the way it was recorded. Software with 2 channel audio signals is decoded with Dolby Pro Logic to create surround effects (4 channels).

■ PLII MOV (Pro Logic II Movie)

Performs the Pro Logic II movie mode decoding. This setting is ideal for the movies encoded in Dolby Surround. Besides, this mode can reproduce the sound in 5.1 channel when watching the videos of old movies or in the dubbed language.

■ PLII MUS (Pro Logic II Music)

Performs the Pro Logic II music mode decoding. This setting is ideal for normal stereo sources such as CDs.

Tip

You can also use **□□PLII** on the receiver to select "DOLBY PL", "PLII MOV" or "PLII MUS".

Note

Dolby Pro Logic and Dolby Pro Logic II decoding does not function for DTS format signals.

Selecting a sound field

You can enjoy surround sound simply by selecting one of the pre-programmed sound fields according to the program you want to listen to.

Using only the front speakers (2 Channels Stereo)

Press SOUND FIELD +/- repeatedly to select "2CH ST."

This mode outputs the sound from the front left and right speakers only. Standard 2 channel (stereo) sources completely bypass the sound field processing. Multi channel surround formats are downmixed to 2 channel.

Notes

- No sound is output from the sub woofer when "2CH ST." is selected. To listen to 2 channel (stereo) sources using the front left and right speakers and a sub woofer, press A.F.D. to select "A.F.D. AUTO".
- When you select "Micro Satellite Speaker" (page 14), internal sound processor will automatically redirect bass sound to subwoofer. If you want to listen to two channel (stereo) sources under this setting, we recommend that you choose "A.F.D. AUTO" mode so that you can take advantage of your sub woofer to obtain the correct bass signal.

Selecting other sound fields

Press SOUND FIELD +/- repeatedly to select the sound field you want.

The current sound field is indicated in the display. See pages 21–22 for information on each sound field.

About DCS (Digital Cinema Sound)

DCS

In collaboration with Sony Pictures Entertainment, Sony measured the sound environment of their studios and integrated the data of the measurement and Sony's own DSP (Digital Signal Processor) technology to develop "Digital Cinema Sound". In a home theater, "Digital Cinema Sound" simulates an ideal movie theater sound environment based on the preference of the movie director.

■ **C.ST.EX A–C (Cinema Studio EX A–C)** **DCS**

- C.ST.EX A reproduces the sound characteristics of the Sony Pictures Entertainment "Cary Grant Theater" cinema production studio. This is a standard mode, great for watching most any type of movie.
- C.ST.EX B reproduces the sound characteristics of the Sony Pictures Entertainment "Kim Novak Theater" cinema production studio. This mode is ideal for watching science-fiction or action movies with lots of sound effects.
- C.ST.EX C reproduces the sound characteristics of the Sony Pictures Entertainment scoring stage. This mode is ideal for watching musicals or classic films where music is featured in the soundtrack.

continued

Selecting a sound field (continued)

About Cinema Studio EX

Cinema Studio EX consists of the following three elements.

- **Virtual Multi Dimension**
Creates 5 sets of virtual speakers surrounding the listener from a single pair of actual surround speakers.
- **Screen Depth Matching**
In a movie theater, sound seems to come from inside the image reflected on the movie screen. This element creates the same sensation in your listening room by shifting the sound of the front speakers “into” the screen.
- **Cinema Studio Reverberation**
Reproduces the reverberations peculiar to a movie theater.

Cinema Studio EX is the integrated mode which operates these elements simultaneously.

Notes

- The effects provided by the virtual speakers may cause increased noise in the playback signal.
- When listening with sound fields that employ the virtual speakers, you will not be able to hear any sound coming directly from the surround speakers.

■ **HALL**

Reproduces the acoustics of a rectangular concert hall.

■ **JAZZ (Jazz Club)**

Reproduces the acoustics of a jazz club.



■ **CONCERT (Live Concert)**

Reproduces the acoustics of a 300-seat live house.

To turn the surround effect off

Press A.F.D. to select “A.F.D. AUTO” or press SOUND FIELD +/- repeatedly to select “2CH ST.”.

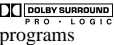
Tips

- The receiver memorizes the last sound field selected for each program source (Sound Field Link). Whenever you select a program source, the sound field that was last applied is automatically applied again. For example, if you listen to DVD with “HALL” as the sound field, change to a different program source, then return to DVD, “HALL” will be applied again.
- You can identify the encoding format of DVD software, etc. by looking at the logo on the package.
 - : Dolby Digital discs
 - : Dolby Surround encoded programs
 - : DTS Digital Surround encoded programs

Understanding the multi channel surround displays



- 1 **DIGITAL:** Lights up when the receiver is decoding signals recorded in the Dolby Digital format.
- 2 **DTS:** Lights up when DTS signals are input.
- 3 **SW:** Lights up when sub woofer selection is set to “YES” (page 16) and the audio signal is output from the SUB WOOFER jacks.
- 4 **Playback channel indicators:** The letters (L, C, R, etc.) indicate the channels being played back.

The boxes around the letters vary to show how the receiver downmixes the source sound (based on the speakers settings). When using sound fields like “C.ST.EX”, the receiver adds reverberation based on the source sound.

L (Front Left), R (Front Right), C (Center (monaural)), SL (Surround Left), SR (Surround Right), S (Surround (monaural or the surround components obtained by Pro Logic processing))

Example:

Recording format (Front/Surround): 3/2
 Output channel: Surround speakers absent
 Sound Field: A.F.D. AUTO

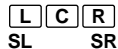

- 5 **Tuner indicators:** Light up when using the receiver to tune in radio stations, etc. See pages 26–29 for tuner operations.

Note

“RDS” only appears for models of area code CEL, CEK only.

- 6 **D.RANGE:** Lights up when dynamic range compression is activated. See page 24 to adjust the dynamic range compression.
- 7 **COAX:** Lights up when the source signal is a digital signal being input through the COAX terminal.
- 8 **OPT:** Lights up when the source signal is a digital signal being input through the OPT terminal.
- 9 **LFE:** Lights up when the disc being played back contains the LFE (Low Frequency Effect) channel and when the sound of the LFE channel signal is actually being reproduced.
- 10 **PRO LOGIC II:** “**PRO LOGIC**” lights up when the receiver applies Pro Logic processing to 2 channel signals in order to output the center and surround channel signals. “**PRO LOGIC II**” lights up when Pro Logic II processing (“PLII MOV” or “PLII MUS”) is applied (page 20). However, both indicators do not light up if the center and surround speakers are set to “NO”, and “A.F.D. AUTO”, “DOLBY PL”, “PLII MOV” or “PLII MUS” is selected.

Note

Dolby Pro Logic and Dolby Pro Logic II decoding does not function for DTS format signals.

Customizing sound fields

By adjusting the surround parameters and the tone characteristics of the front speakers, you can customize the sound fields to suit your particular listening situation.

Once you customize a sound field, the changes are stored in the memory indefinitely. You can change a customized sound field any time by making new adjustments to the parameters.

See the tables on back page for the parameters available in each sound field.

To get the most from multi channel surround sound



Position your speakers and do the procedures described in “Multi channel surround setup” starting from page 14 before you customize a sound field.

Adjusting the level parameters

The LEVEL menu contains parameters that let you adjust the balance and volumes of each speaker. You can also customize various aspects of current sound field. The setting are applied to all sound field except for EFCT. parameter. For EFCT. parameter, the settings are stored individually for each sound field.

- 1 **Start playing a program source encoded with multi channel surround sound.**
- 2 **Press MAIN MENU repeatedly to select “<LEVEL>”.**
- 3 **Press \blacktriangle or \blacktriangledown to select the parameter you want to adjust.**
- 4 **Press \blacktriangleleft or \blacktriangleright to select the setting you want.**
The setting is entered automatically.

Initial settings

Parameter	Initial setting
  BAL. L/R XX	BALANCE
CTR XXX dB	0 dB
SUR.L. XXX dB	0 dB
SUR.R. XXX dB	0 dB
S.W. XXX dB	0 dB
 COMP. XXX	OFF
EFCT. XXX	STD

Front balance (BAL. L/R XX)

Lets you adjust the balance between front left and right speakers.

Center level (CTR XXX dB)

Lets you adjust the level of the center speaker.

Surround left level (SUR.L. XXX dB)

Lets you adjust the level of the surround left speaker.

Surround right level (SUR.R. XXX dB)

Lets you adjust the level of the surround right speaker.

Sub woofer level (S.W. XXX dB)

Lets you adjust the level of the sub woofer.

Dynamic range compressor

(**D. RANGE** COMP. XXX)

Lets you compress the dynamic range of the sound track. This may be useful when you want to watch movies at low volumes late at night. We recommend using the “MAX” setting.

- To reproduce the sound track with no compression, select “OFF”.
- To reproduce the sound track with the dynamic range intended by the recording engineer, select “STD”.
- To reproduce a dramatic compression of the dynamic range, select “MAX”.

Note

Dynamic range compression is possible with Dolby Digital sources only.

Effect level (EFCT. XXX)

Lets you adjust the “presence” of the current surround effect.

Adjusting the tone parameters

The TONE menu contains parameters that let you adjust the tone of the front speakers for optimum sound. The settings are applied to all sound fields.

- 1 Start playing a program source encoded with multi channel surround sound.**
- 2 Press MAIN MENU repeatedly to select “<TONE>”.**
- 3 Press \uparrow or \downarrow to select the parameter you want to adjust.**
- 4 Press \leftarrow or \rightarrow to select the setting you want.**

The setting is entered automatically.

Initial settings

Parameter	Initial setting
BASS XX dB	0 dB
TREB. XX dB	0 dB

Bass (BASS XX dB)

Lets you adjust the bass tone.

Treble (TREB. XX dB)

Lets you adjust the treble tone.

Note

When you use the Micro Satellite Speakers or other small speakers, adjust LEVEL on the sub woofer (page 18) to reinforce the bass.

Resetting customized sound fields to the factory settings

- 1 If the power is on, press I/⏻ to turn off the power.**
- 2 Hold down SOUND FIELD on the receiver and press I/⏻ on the receiver.** “SF. CLR.” appears in the display and all sound fields are reset at once.

Receiving Broadcasts

Before receiving broadcasts, make sure you have connected FM and AM antennas to the receiver (see page 7).

Storing FM stations automatically (AUTOBETICAL)

(Models of area code CEL, CEK only)
This function lets you store up to 30 FM and FM RDS stations in alphabetical order without redundancy. Additionally, it only stores the stations with the clearest signals.

If you want to store FM or AM stations one by one, see “Presetting radio stations” on page 27.

- 1 Press **I/⏻** to turn off the receiver.
- 2 Hold down **INPUT SELECTOR** on the receiver and press **I/⏻** on the receiver to turn the receiver back on.

“AUTO-BETICAL SELECT” appears in the display and the receiver scans and stores all the FM and FM RDS stations in the broadcast area.

For RDS stations, the tuner first checks for stations broadcasting the same program, then stores only the one with the clearest signal. The selected RDS stations are sorted alphabetically by their Program Service name, then assigned a 2-character preset code. For more details on RDS, see page 28.

Regular FM stations are assigned 2-character preset codes and stored after the RDS station.

When done, “FINISH” appears in the display momentarily and the receiver returns to the normal operation.

Notes

- Do not press any button on the receiver or supplied remote during autobetrical operation.
- If you move to another area, repeat this procedure to store stations in your new area.
- For details on tuning the stored stations, see page 28.
- If you move the antenna after storing stations with this procedure, the stored settings may no longer be valid. If this happens, repeat this procedure to store the stations again.

Direct tuning

You can enter a frequency of the station you want directly by using the numeric buttons on the supplied remote.

- 1 Press **TUNER** repeatedly to select the **FM or AM band**.

The last received station is tuned in.

- 2 Press **D.TUNING**.

- 3 Press the numeric buttons to enter the frequency.

Example 1: FM 102.50 MHz

① → ② → ⑤ → ② → ①

Example 2: AM 1350 kHz

① → ③ → ⑤ → ①

If you cannot tune in a station and the entered numbers flash

Make sure you’ve entered the right frequency. If not, repeat steps 2 and 3.

If the entered numbers still flash, the frequency is not used in your area.

- 4 If you’ve tuned in an AM station, adjust the direction of the AM loop antenna for optimum reception.
- 5 Repeat steps 1 to 4 to receive another station.

Tips

- If you do not remember the precise frequency, press TUNING + or TUNING – after entering the value close to the frequency you want. The receiver automatically tunes in the station you want. If the frequency seems to be higher than the entered value, press TUNING +, and if the frequency seems to be lower than the entered value, press TUNING –.
- If “STEREO” flashes in the display and the FM stereo reception is poor, press FM MODE to change to monaural (MONO). You will not be able to enjoy the stereo effect, but the sound will be less distorted. To return to stereo mode, press FM MODE again.

The tuning scale differs depending on the area code as shown in the following table. For details on area codes, see page 4.

Area code	FM	AM
CEL, CEK, SP	50 kHz	9 kHz

Automatic tuning

If you don't know the frequency of the station you want, you can let the receiver scan all available stations in your area.

- 1 Press TUNER repeatedly to select the FM or AM band.**
The last received station is tuned in.
- 2 Press TUNING + or TUNING –.**
Press TUNING + to scan from low to high; press TUNING – to scan from high to low. The receiver stops scanning whenever a station is received.
When the receiver reaches either end of the band
Scanning is repeated in the same direction.
- 3 To continue scanning, press TUNING + or TUNING – again.**

Preset tuning

After you have tuned in stations using Direct Tuning or Automatic Tuning, you can preset them to the receiver. Then you can tune in any of the stations directly by entering its 2-character preset code using the supplied remote. Up to 30 FM or AM stations can be preset. The receiver will also scan all the stations that you have preset.

Before tuning to preset stations, be sure to preset them by performing steps on “Presetting radio stations”.

Presetting radio stations

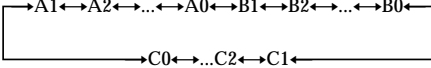
- 1 Press TUNER.**
The last received station is tuned in.
 - 2 Tune in the station that you want to preset using Direct Tuning (page 26) or Automatic Tuning (page 27).**
 - 3 Press MEMORY.**
“MEMORY” appears in the display for a few seconds.
Do steps 4 to 5 before “MEMORY” goes out.
 - 4 Press PRESET + or PRESET – repeatedly to select a preset number.**
Each time you press the button, the preset station number changes in the corresponding order and direction as follows:

```
→A1↔A2↔...↔A0↔B1↔B2↔...↔B0↔
↔C0↔...C2↔C1←
```
- If “MEMORY” goes out before you press the preset station number, start again from step 3.

continued

Preset tuning (continued)

- 5 Press **MEMORY** again to store the station.

If “MEMORY” goes out before you can store the station, start again from step 3.

- 6 Repeat steps 2 to 5 to preset another station.

To change a preset number to another station

Do steps 1 to 5 to preset a new station to the number.

Tuning to preset stations

You can tune the preset stations by either of the following two ways.

Scanning the preset stations

- 1 Press **TUNER**.

The last received station is tuned in.

- 2 Press **PRESET +** or **PRESET -** repeatedly to select the preset station you want.

Each time you press the button, the receiver tunes in one preset station at a time, in the corresponding order and direction as follows:

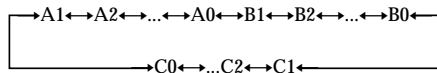

Using the preset codes

- 1 Press **TUNER**.

The last received station is tuned in.

- 2 Press **SHIFT** to select a memory page (A, B, or C), then press the preset number of the station you want using the numeric buttons.

Tip

You can also use **PRESET TUNING +/-** on the receiver to tune to preset stations.

Using the Radio Data System (RDS)

(Models of area code CEL, CEK only)

This receiver also allows you to use RDS (Radio Data System), which enables radio stations to send additional information along with the regular program signal.

Note that RDS is operable only for FM stations.*

* Not all FM stations provide RDS service, nor do they provide the same types of services. If you are not familiar with the RDS services in your area, check with your local radio stations for details.

Receiving RDS broadcasts

Simply select a station on the FM band using direct tuning (page 26), automatic tuning (page 27), or preset tuning (page 27).

When you tune in a station that provides RDS services, the RDS indicator lights up and the program station name normally appears in the display.

Note

RDS may not work properly if the station you tuned to is not transmitting the RDS signal properly or if the signal strength is weak.

Displaying RDS information

While receiving an RDS station, press DISPLAY.

Each time you press the button, RDS information on the display changes cyclically as follows:

Program Station name → Frequency → Program Type indication^{a)} → Radio Text indication^{b)} → Current Time indication (in 24-hour system) → Sound field currently applied → Volume

- a) Type of program being broadcast (page 29).
- b) Text messages sent by the RDS station.

Notes

- If there is an emergency announcement by government authorities, "ALARM" flashes in the display.
- When the message consists of 9 characters or more, the message scrolls across the display.
- If a station does not provide a particular RDS service, "NO XXXX" (such as "NO TEXT") appears in the display.

Description of program types

Program type indication	Description
NEWS	News programs
AFFAIRS	Topical programs that expand on current news
INFO	Programs offering information on a wide spectrum of subjects, including consumer affairs and medical advice
SPORT	Sports programs
EDUCATE	Educational programs, such as "how-to" and advice programs
DRAMA	Radio plays and serials
CULTURE	Programs about national or regional culture, such as language and social concerns

Program type indication	Description
SCIENCE	Programs about the natural sciences and technology
VARIED	Other types of programs such as celebrity interviews, panel games, and comedy
POP M	Popular music programs
ROCK M	Rock music programs
EASY M	Easy Listening
LIGHT M	Instrumental, vocal, and choral music
CLASSICS	Performances of major orchestras, chamber music, opera, etc.
OTHER M	Music that does not fit into any categories above, such as Rhythm & Blues and Reggae
WEATHER	Weather information
FINANCE	Stock market reports and trading, etc.
CHILDREN	Programs for children
SOCIAL	Programs about people and the things that affect them
RELIGION	Programs of religious content
PHONE IN	Programs where members of the public express their views by phone or in a public forum
TRAVEL	Programs about travel. Not for announcements that are located by TP/TA
LEISURE	Programs on recreational activities such as gardening, fishing, cooking, etc.
JAZZ	Jazz programs
COUNTRY	Country music programs
NATION M	Programs featuring the popular music of the country or region
OLDIES	Programs featuring oldies music
FOLK M	Folk music programs
DOCUMENT	Investigative features
NONE	Any programs not defined above

Using the Sleep Timer

You can set the receiver to turn off automatically at a specified time.

After pressing ALT (page 35), press SLEEP while the power is on.

Each time you press the button, the display changes cyclically as follows:

2-00-00 → 1-30-00 → 1-00-00 → 0-30-00
→ OFF

The display dim after you have specified the time.

Tip

To check the remaining time before the receiver turns off, press ALT, then press SLEEP. The remaining time appears in the display.

Adjustments using the SET UP menu

The SET UP menu allows you to make the following adjustments.

- 1 Press MAIN MENU repeatedly to select “<SET UP>”.
- 2 Press ↑ or ↓ to select the parameter you want to adjust.
- 3 Press ← or → to select the setting you want.
The setting is entered automatically.
- 4 Repeat steps 2 to 3 until you have set all of the parameters that follow.

Initial settings

Parameter	Initial setting
DVD-XXXX	AUTO
TV-XXXX	AUTO
DEC. XXXX	PCM (for DVD), AUTO (for TV/SAT)

■ Audio input mode for DVD function (DVD-XXXX)

Lets you select the audio input mode for DVD function.

- “AUTO” gives priority to digital signals when there are both digital and analog connections. If there are no digital signals, analog is selected.
- “OPT” specifies the digital audio signals input to the DIGITAL DVD OPT IN jacks.
- “COAX” specifies the digital audio signals input to the DIGITAL DVD COAX IN jacks.
- “ANLG” specifies the analog audio signals input to the DVD IN (L/R) jacks.

■ **Audio input mode for TV/SAT function (TV-XXXX)**

Lets you select the audio input mode for TV/SAT function.

- “AUTO” gives priority to digital signals, when there are both digital and analog connections. If there are no digital signals, analog is selected.
- “OPT” specifies the digital audio signals input to the DIGITAL TV/SAT OPT IN jacks.
- “ANLG” specifies the analog audio signals input to the TV/SAT IN (L/R) jacks.

■ **Decode priority (DEC. XXXX)**

Sets the appropriate decoding for incoming digital signals.

- PCM priority mode (DEC. PCM)
Use to enjoy playback from audio CD (PCM) and DVD. When used with media other than CD or DVD, you may experience noise. If this happens, switch to AUTO mode.
- AUTO mode (DEC. AUTO)
Use to enjoy playback from audio CD (PCM), DVD, DTS-CD and DTS-LD sources. However, with audio CDs, you may not be able to listen the very first moments of each track.

Normally, use as-is with the initial settings above.



Operation using the Remote RM-U40

You can use the remote to operate the components in your system.

Before you use your remote

Inserting batteries into the remote

Insert R6 (size-AA) batteries with the + and – properly oriented in the battery compartment. When using the remote, point it at the remote sensor on the receiver.

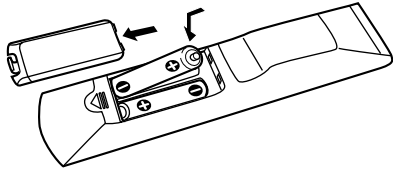

Tip

Under normal conditions, the batteries should last for about 6 months. When the remote no longer operates the receiver, replace all batteries with new ones.

Notes

- Do not leave the remote in an extremely hot or humid place.
- Do not use a new battery with an old one.
- Do not expose the remote sensor to direct sunlight or lighting apparatuses. Doing so may cause a malfunction.
- If you don't use the remote for an extended period of time, remove the batteries to avoid possible damage from battery leakage and corrosion.

Remote button description

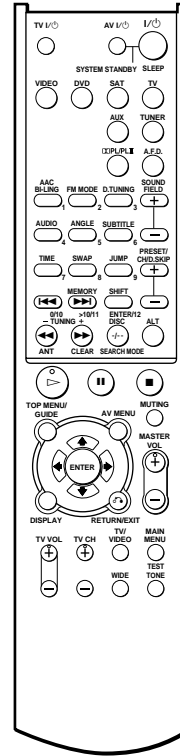

The tables below show the settings of each button.

Remote Button	Operations	Function
I/⏻	Receiver	Turns the receiver on or off.
SLEEP	Receiver	Activates the sleep function and the duration which the receiver turns off automatically.

Remote Button	Operations	Function
VIDEO	Receiver	To watch VCR.
DVD	Receiver	To watch DVD.
TV	Receiver	To watch TV programs.
SAT	Receiver	To watch satellite tuner.
TUNER	Receiver	To listen to radio programs.
AUX	Receiver	To listen to an audio equipment.
SHIFT	Receiver	Press repeatedly to select a memory page for presetting radio stations or tuning to preset stations.
D.TUNING	Receiver	Tuner station direct key-in-mode.
TUNING +/-	Receiver	Scans radio stations.
MEMORY	Receiver	Stores the radio stations.
FM MODE	Receiver	Selects FM monaural or stereo reception.
MUTING	Receiver	Mutes the sound from the receiver.
↑/↓	Receiver	Select a menu item.
←/→	Receiver	Makes adjustment or change the setting.
MASTER VOL +/-	Receiver	Adjust the master volume of the receiver.
MAIN MENU	Receiver	Selects menus.

Remote Button	Operations	Function
SOUND FIELD +/-	Receiver	Selects sound fields.
TEST TONE	Receiver	Press to output test tone.
A.F.D.	Receiver	Selects A.F.D. AUTO.
□□PL/PLII	Receiver	Selects DOLBY PL, PLII MOV, and PLII MUS.
AV I/⏻	TV/VCR/ CD player/ DVD player	Turns the audio and video components on or off.
SYSTEM STANDBY (Press AV I/⏻ and I/⏻ at the same time)	Receiver/TV/ VCR/Satellite tuner/ CD player/ DVD player	Turns off the receiver and other Sony audio/video components.
1-9 and 0/10	Receiver	Use with "SHIFT" button to preset radio station or tuning to preset stations and with "D.TUNING" for direct tuning.
	CD player	Selects track numbers. 0/10 selects track 10.
	TV/VCR/ Satellite tuner	Selects channel numbers.
>10/11	CD player	Selects track numbers over 10.
AUDIO	TV/VCR/ DVD player	Changes the sound to Multiplex, Bilingual or Multi channel TV Sound.

continued

Operations Using the Remote RM-U40

Remote button description (continued)

Remote Button	Operations	Function
TIME	CD player/ DVD player	Shows the time or displays the playing time of disc, etc.
PRESET/ CH/	Receiver	Scans and selects preset stations.
D.SKIP +/-	TV/VCR/ satellite tuner CD player/ DVD player	Selects preset channels. Skips discs (multi-disc changer only).
ENTER/12	TV/VCR/ satellite tuner	After selecting a channel, disc or track using the numeric buttons, press to enter the value.
DISC	CD player	Selects a disc directly (multi-disc changer only).
DISPLAY	TV/VCR/ DVD player	Selects information displayed on the TV screen.
ANT	VCR	Selects output signal from aerial terminal: TV signal or VCR program.
⏮/⏭	VCR/ CD player/ DVD player	Skips tracks.
⏪/⏩	CD player/ DVD player	Searches tracks (forward or backward).
	VCR	Fast forwards or rewinds.
▶	VCR/ CD player/ DVD player	Starts play.

Remote Button	Operations	Function
⏸	VCR/ CD player/ DVD player	Pauses play or record. (Also starts recording with components in record standby.)
■	VCR/ CD player/ DVD player	Stops play.
AV MENU	VCR/Satellite tuner/ DVD player	Displays menu.
⬆/⬇/⬅/➡	VCR/Satellite tuner/ DVD player	Selects a menu item. Press to enter the selection.
ENTER	VCR/Satellite tuner/ DVD player	Press to enter the selection.
RETURN ⏪/EXIT	DVD player Satellite tuner	Returns to the previous menu or exits the menu. Exits the menu.
SUBTITLE	DVD player	Changes the subtitles.
ANGLE	DVD player	To select viewing angle or changes the angles.
CLEAR	DVD player	Press if you made a mistake when you press the number button or press to return to the continuous play etc.

Remote Button	Operations	Function
SEARCH MODE	DVD player	Select searching mode. Press to select the unit for search (track, index, etc.)
TOP MENU/	DVD player	Displays DVD title.
GUIDE	Satellite tuner	Displays guide menu.
TV I/⏻	TV	Turns the TV on or off.
-/--	TV	Selects the channel entry mode, either one or two digit.
TV VOL +/-	TV	Adjust the volume of the TV.
TV CH +/-	TV	Select preset TV channels.
TV/VIDEO	TV	Selects input signal: TV input or video input.
WIDE	TV	Selects the wide picture mode.
SWAP*	TV	Swaps the small and large picture.
JUMP	TV	Toggles between the previous and the current channels.

Remote Button	Operations	Function
ALT	Remote	Change remote key function to activate those buttons with orange printing.

* Only for Sony TVs with the picture-in-picture function.

Notes

- The above explanation is intended to serve as an example only. Therefore, depending on the component the above operation may not be possible or may operate differently than described.
- To activate the buttons with orange printing, press ALT first before pressing the buttons.
- Press MAIN MENU on the remote before you use the  buttons for receiver operation.
- Press TOP MENU/GUIDE or AV MENU on the remote before you use the remote to control the satellite tuner, VCR and DVD player.
- The AUX and AAC BI-LING functions are not available for set operation.

Changing the factory setting of an input selector button

If the factory settings of the input selector buttons do not match your system components, you can change them. For example, if you have a CD player and you do not have a DVD player, you can assign the DVD button to your CD player.

- 1 Hold down the input selector button whose input source you want to change (for example, DVD).**
- 2 Press the corresponding button of the component you want to assign to the input selector button (for example, 1 – CD player).**

The following buttons are assigned to select the input source:

To operate	Press
CD player	1
VCR (command mode VTR 2*)	2
VCR (command mode VTR 3*)	3
DVD player	4
TV	5
DSS (Digital Satellite Receiver)	6
Tuner (this receiver)	7
DCS (Digital CS Tuner)	8
BSD (Digital BS Tuner)	9
Tuner (Component Tuner)	0/10

* Sony VCRs are operated with a VTR 2 or 3 setting. These correspond to 8mm and VHS respectively.

Now you can use the DVD button to control the CD player.

To reset a button to its factory setting

Repeat the above procedure.

To reset all the input selector buttons to their factory setting

Press I/⏪, AV I/⏪ and MASTER VOL – at the same time.

Additional Information

Precautions

On safety

Should any solid object or liquid fall into the cabinet, unplug the receiver and have it checked by qualified personnel before operating it any further.

On power sources

- Before operating the unit, check that the operating voltage is identical with your local power supply. The operating voltage is indicated on the nameplate at the rear of the receiver.
- The unit is not disconnected from the AC power source (mains) as long as it is connected to the wall outlet, even if the receiver itself has been turned off.
- If you are not going to use the receiver for a long time, be sure to disconnect the receiver from the wall outlet. To disconnect the AC power cord, grasp the plug itself; never pull the cord.
- AC power cord must be changed only at the qualified service shop.

On heat buildup

Although the unit heats up during operation, this is not a malfunction. If you continuously use this unit at a large volume, the cabinet temperature of the top, side and bottom rises considerably. To avoid burning yourself, do not touch the cabinet.

On placement

- Place the receiver in a location with adequate ventilation to prevent heat buildup and prolong the life of the receiver.
- Do not place the receiver near heat sources, or in a place subject to direct sunlight, excessive dust or mechanical shock.
- Do not place anything on top of the cabinet that might block the ventilation holes and cause malfunctions.
- Use caution when placing the unit or speakers on surfaces that have been specially treated (with wax, oil, polish, etc.) as staining or discoloration of the surface may result.

On operation

Before connecting other components, be sure to turn off and unplug the receiver.

If you encounter color irregularity on a nearby TV screen

This speaker system is magnetically shielded to allow it to be installed near a TV set. However, color irregularities may still be observed on certain types of TV sets.

If color irregularity is observed...

Turn off the TV set once, then turn it on again after 15 to 30 minutes.

If color irregularity is observed again...

Place the speaker further away from the TV set.

If howling occurs

Reposition the speakers or turn down the volume on the receiver.

On cleaning

Clean the cabinet, panel and controls with a soft cloth slightly moistened with a mild detergent solution. Do not use any type of abrasive pad, scouring powder or solvent such as alcohol or benzine.

If you have any question or problem concerning your receiver, please consult your nearest Sony dealer.

Troubleshooting

If you experience any of the following difficulties while using the receiver, use this troubleshooting guide to help you remedy the problem. Also, see "Checking the connections" on page 19 to verify that the connections are correct.

There is no sound or only a very low-level/sound no matter which component is selected.

- Check that the speakers and components are connected securely and correctly.
- Check that both the receiver and all components are turned on.
- Check that the MASTER VOLUME control is not set at "VOL MIN".
- Press MUTING to cancel the muting function.
- The protective device on the receiver has been activated because of a short circuit ("PROTECT" flashes). Turn off the receiver, eliminate the short-circuit problem and turn on the power again.

continued

Troubleshooting (continued)

There is no sound from a specific component.

- Check that the component is connected correctly to the audio input jacks for that component.
- Check that the cord(s) used for the connection is (are) fully inserted into the jacks on both the receiver and the component.
- Check that you have selected the correct component on the receiver.

There is no sound from one of the front speakers.

- Check that the component is connected correctly to the audio input jacks for that component.
- Check that the cord(s) used for the connection is (are) fully inserted into the jacks on both the receiver and the component.

The multi channel surround effect of the Dolby Digital or DTS is not obtained.

- Check that the DVD software, etc. is recorded in Dolby Digital or DTS format.
- If you connect the DVD player, etc. to the digital input jack on this system, check the audio setting (for digital audio output) of the component.
- Check that the audio track is correctly selected on the DVD player. (Check the audio setting of the DVD menu.)

The left and right sounds are unbalanced or reversed.

- Check that the speakers and components are connected correctly and securely.
- Adjust balance parameters in the LEVEL menu.

There is severe hum or noise.

- Check that the speakers and components are connected securely.
- Check that the connecting cords are away from a transformer or motor, and at least 3 meters away from a TV set or fluorescent light.
- Move your TV away from the audio components.
- The plugs and jacks are dirty. Wipe them with a cloth slightly moistened with alcohol.

There is no sound or only a very low-level sound is heard from the center or/and surround speakers.

- Make sure the sound field function is on (press SOUND FIELD +/-).
- Select a sound field containing the word "C.ST.EX" (page 21).
- Adjust the speaker level (page 18).
- Make sure the center or/and surround speaker size parameter is set to "SMALL" or "LARGE" (page 17).

There is no sound from the active sub woofer.

- When you select NORM. SP., make sure the sub woofer is set to "YES" (see page 14).
- Check that the sub woofer is connected correctly and securely.
- There is no sound output from the SUB WOOFER terminal depending on the sound field (back page).

The FM reception is poor.

Use a 75-ohm coaxial cable (not supplied) to connect the receiver to an outdoor FM antenna as shown below. If you connect the receiver to an outdoor antenna, ground it against lightning. To prevent a gas explosion, do not connect the ground wire to a gas pipe.

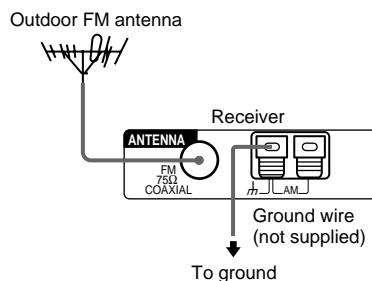

Radio stations cannot be tuned in.

- Check that the antennas are connected securely. Adjust the antennas and connect an external antenna if necessary.
- The signal strength of the stations is too weak (when tuning in with automatic tuning). Use Direct tuning.
- No stations have been preset or the preset stations have been cleared (when tuning by scanning preset stations). Preset the stations (see page 27).

RDS does not work.*

- Make sure that you're tuned to an FM RDS station.
- Select a stronger FM station.

The RDS information that you want does not appear.*

Contact the radio station and find out whether they actually provide the service in question. If so, the service may be temporarily out of order.

The surround effect cannot be obtained.

Make sure the sound field function is on (press SOUND FIELD +/-).

There is no picture or an unclear picture appears on the TV screen or monitor.

- Select the appropriate input selector on the receiver.
- Set your TV to the appropriate input mode.
- Move your TV away from the audio components.

The remote does not function.

- The AUX and AAC BI-LING buttons on the remote are not available.
- Point the remote at the remote sensor  on the receiver.
- Remove any obstacles in the path between the remote and the receiver.
- Replace both batteries in the remote with new ones, if they are weak.
- Make sure you select the correct input selector on the remote.
- If the remote is set to operate the TV only, use the remote to select a source or component other than TV before operating the receiver or other component.

If you are unable to remedy the problem using the troubleshooting guide

Clearing the receiver's memory may remedy the problem (page 13). However, note that all memorized settings will have to readjust all settings on the receiver.

If the problem persists
Consult your nearest Sony dealer.

* Models of area code CEL, CEK only.

Clearing the receiver's memory

To clear	See
All memorized settings	page 13
Customized sound fields	page 24

Specifications

Amplifier section

POWER OUTPUT

Models of area code CEL,CEK

Rated Power Output at Stereo Mode

(8 ohms 1 kHz, THD 0.7 %)

25 W + 25 W²⁾

Reference Power Output²⁾

(8 ohms 1 kHz, THD 10 %)

FRONT¹⁾: 35 W/ch

CENTER¹⁾: 35 W

SURR¹⁾: 35 W/ch

Models of other area code

Rated Power Output at Stereo Mode

(8 ohms 1 kHz, THD 0.7 %)

20 W + 20 W²⁾

Reference Power Output²⁾

(8 ohms 1 kHz, THD 10 %)

FRONT¹⁾: 30 W/ch

CENTER¹⁾: 30 W

SURR¹⁾: 30 W/ch

1) Depending on the sound field settings and the source, there may be no sound output.

2) Measured under the following conditions:

Area code	Power requirements
SP, CEL, CEK	230 V AC, 50 Hz

Frequency response

TV/SAT, DVD, VIDEO: 10 Hz – 50 kHz
+0.5/-3 dB (with sound field and tone by passed)

Inputs (Analog)

TV/SAT, DVD, VIDEO: Sensitivity: 250 mV
Impedance: 50 kilohms
S/N³⁾: 96 dB
(A, 250 mV⁴⁾)

3) INPUT SHORT (with sound field and tone by passed).

4) Weighted network, input level.

Inputs (Digital)

DVD (Coaxial) Sensitivity: –
Impedance: 75 ohms
S/N: 100 dB
(A, 20 kHz LPF)

DVD, TV/SAT (Optical) Sensitivity: –
Impedance: –
S/N: 100 dB
(A, 20 kHz LPF)

Outputs

SUB WOOFER Voltage: 2 V
Impedance: 1 kilohms

Tone

Gain levels: ±6 dB, 1 dB step

Video section

Inputs

Video: 1 V_{p-p}, 75 ohms

Outputs

Video: 1 V_{p-p}, 75 ohms

FM tuner section

Tuning range 87.5 – 108.0 MHz

Antenna terminals 75 ohms, unbalanced

Intermediate frequency

10.7 MHz

Sensitivity

Mono: 18.3 dBf, 2.2 μV/75 ohms
Stereo: 38.3 dBf, 22.5 μV/75 ohms

Usable sensitivity

11.2 dBf, 1 μV/75 ohms

S/N

Mono: 76 dB
Stereo: 70 dB

Harmonic distortion at 1 kHz

Mono: 0.3%
Stereo: 0.5%

Separation

45 dB at 1 kHz

Frequency response

30 Hz – 15 kHz
+0.5/-2 dB

Selectivity

60 dB at 400 kHz

AM tuner section

Tuning range

Models of area code **CEL, CEK, SP**

With 9-kHz tuning scale: 531 – 1602 kHz

Antenna	Loop antenna
Intermediate frequency	450 kHz
Usable sensitivity	50 dB/m (at 999 kHz)
S/N	54 dB (at 50 mV/m)
Harmonic distortion	0.5% (50 mV/m, 400 Hz)
Selectivity	At 9 kHz: 35 dB

General

Power requirements

Area code	Power requirements
CEL, CEK	230 V AC, 50/60 Hz
SP	220 – 230 V AC, 50/60 Hz

Power consumption

Area code	Power consumption
CEL, CEK	130 W
SP	105 W

Power consumption (during standby mode)

0.3 W

Dimensions (w/h/d)

STR-KSL60/STR-KSL50: 430 × 56 × 290 mm
 STR-KSL40: 430 × 56 × 288 mm
 including projecting parts and controls

Mass (Approx.) 4.5 kg

Speaker Section

For HT-SL70, HT-SL65 only

- **SS-SLP70** for front and surround speakers
- **SS-CNP70** for center speaker

For HT-SL55 only

- **SS-MSP55** for front and surround speakers
- **SS-CNP55** for center speaker

For HT-SL60, HT-SL50 and HT-SL40 only

- **SS-MSP50** for front and surround speakers
- **SS-CNP50** for center speaker

Speaker system Full range, magnetically shielded

Speaker units

SS-SLP70/SS-CNP70	40 × 70 mm, cone type
SS-MSP55	80 mm, cone type
SS-CNP55	55 mm, cone type
SS-MSP50/SS-CNP50	55 × 110 mm, cone type

Enclosure type Bass reflex

Rated Impedance 8 ohms

Power handling capacity (Maximum input power)

SS-SLP70/SS-CNP70	35 W
SS-MSP55/SS-CNP55	60 W
SS-MSP50/SS-CNP50	35 W

Sensitivity level

SS-SLP70/SS-CNP70	84 dB (1 W, 1 m)
SS-MSP55/SS-CNP55	84 dB (1 W, 1 m)
SS-MSP50/SS-CNP50	86 dB (1 W, 1 m)

Frequency range 160 Hz – 20,000 Hz

Dimensions (w/h/d)

SS-SLP70	Approx. 246 × 1053 × 246 mm
SS-CNP70	Approx. 430 × 68 × 76 mm
SS-MSP55	Approx. 105 × 153 × 128 mm
SS-MSP50	Approx. 76 × 162 × 106 mm
SS-CNP55	Approx. 200 × 79 × 131 mm
SS-CNP50	Approx. 280 × 82 × 106 mm

Mass

SS-SLP70	Approx. 4.0 kg
SS-CNP70	Approx. 1.4 kg
SS-MSP55	Approx. 1.2 kg
SS-MSP50	Approx. 0.8 kg
SS-CNP55	Approx. 0.8 kg
SS-CNP50	Approx. 1.0 kg

Additional Information

continued

Specifications (continued)

Sub woofer

- SA-WMSP70 for HT-SL70 and HT-SL65 only
- SA-WMSP50 for HT-SL60, HT-SL55 and HT-SL50 only
- SA-WMSP40 for HT-SL40 only

Speaker system Active subwoofer, magnetically shielded

Speaker unit Woofer: 20 cm cone type

Enclosure type Acoustically Loaded Bass Reflex

Continuous RMS power output (6 ohms, 20 – 250 Hz)

SA-WMSP70/ 100 W

SA-WMSP50

SA-WMSP40 75 W

Reproduction frequency range

28 Hz – 200 Hz

High frequency cut-off frequency

150 Hz

Input LINE IN (input pin jack)

Power requirements

Area code	Power requirements
CEL, CEK, SP	230 V AC, 50/60 Hz

Power consumption

SA-WMSP70/ 100 W

SA-WMSP50

SA-WMSP40 75 W

Dimensions (w/h/d)

Approx. 270 × 325 × 398 mm including front panel

Mass

SA-WMSP70/ Approx. 10.0 kg

SA-WMSP50

SA-WMSP40 Approx. 9.0 kg

Supplied accessories

FM wire antenna (1)

AM loop antenna (1)

Remote commander RM-U40 (1)

R6 (size-AA) batteries (2)

Speakers

• Front speakers (2)

• Center speaker (1)

• Surround speakers (2)

• Sub woofer (1)

Speaker cords (long) (2)

Speaker cords (short) (3)

Speaker foot pads (20)

(HT-SL60, HT-SL55, HT-SL50 and HT-SL40 only)

Sub woofer foot pads (4)

Coaxial digital cord (1)

Monaural audio cord (1)

Colour label for speakers (5)

For details on the area code of the component you are using, see page 4.

Design and specifications are subject to change without notice.

Tables of settings using MAIN MENU button

You can make various settings using the MAIN MENU button and $\blacktriangle/\blacktriangledown/\blacktriangleleft/\blacktriangleright$ button. The tables below show each of the settings that these buttons can make.

Press MAIN MENU repeatedly to select	Press \blacktriangle or \blacktriangledown to select	Press \blacktriangleleft or \blacktriangleright to select	Page	
<LEVEL>	$\overline{\text{L}}$ $\overline{\text{R}}$ BAL. L/R XX	L +8 to R +8 (1 steps)	24	
	CTR XXX dB	-10 dB to +10 dB (1 dB steps)		
	SUR.L. XXX dB	-10 dB to +10 dB (1 dB steps)		
	SUR.R. XXX dB	-10 dB to +10 dB (1 dB steps)		
	S.W. XXX dB	-10 dB to +10 dB (1 dB steps)		
	$\overline{\text{D}}$ $\overline{\text{RANGE}}$ COMP. XXX	OFF, STD, MAX		
	EFCT. XXX	depends on the sound field (MIN, STD, MAX)		
<TONE>	BASS XX dB	-6 dB to +6 dB (1 dB steps)	25	
	TREB. XX dB	-6 dB to +6 dB (1 dB steps)		
<SET UP>	$\overline{\text{S}}$ $\overline{\text{W}}$ (SUB WOOFER) S.W. XXX*	YES, NO	15	
	$\overline{\text{L}}$ $\overline{\text{R}}$ (FRONT) XXXXX*	LARGE, SMALL		
	$\overline{\text{C}}$ (CENTER) XXXXX*	LARGE, SMALL, NO		
	$\overline{\text{S}}$ $\overline{\text{S}}$ (SURROUND) XXXXX*	LARGE, SMALL, NO		
	$\overline{\text{L}}$ $\overline{\text{R}}$ DIST. X.X m	between 1.0 meter to 7.0 meters (0.1 meter steps)		
	$\overline{\text{C}}$ DIST. X.X m	between $\overline{\text{L}}$ $\overline{\text{R}}$ DIST. and 1.5 meters (0.1 meter steps)		
	$\overline{\text{S}}$ $\overline{\text{S}}$ DIST. X.X m	between $\overline{\text{L}}$ $\overline{\text{R}}$ DIST. and 4.5 meters (0.1 meter steps)		
	$\overline{\text{S}}$ $\overline{\text{S}}$ PL. XXXX	LOW, HIGH		
	DVD-XXXX	AUTO, OPT, COAX, ANLG		30
	TV-XXXX	AUTO, OPT, ANLG		
DEC. XXXX	AUTO, PCM			

* Only when you select "NORM. SP."

Additional Information

Adjustable parameters for each sound field

The adjusted BASS and TREB. parameters are applied to all sound field.

	< TONE >	
	BASS	TREB.
2CH ST.	●	●
A.F.D. AUTO	●	●
DOLBY PL	●	●
PLII MOV	●	●
PLII MUS	●	●
C.ST.EX A	●	●
C.ST.EX B	●	●
C.ST.EX C	●	●
HALL	●	●
JAZZ	●	●
CONCERT	●	●
PCM 96K ¹⁾		

The adjusted LEVEL parameters are applied to all the sound fields except for EFCT. parameter. For EFCT. parameter the settings are stored individually for each sound field.

	< LEVEL >						
	FRONT BAL	CENTER LEVEL	SUR.L. LEVEL	SUR.R. LEVEL	S.W. LEVEL	D.RANGE COMP ²⁾	EFCT. LEVEL
2CH ST.	●					●	
A.F.D. AUTO	●	●	●	●	●	●	
DOLBY PL	●	●	●	●	●	●	
PLII MOV	●	●	●	●	●	●	
PLII MUS	●	●	●	●	●	●	
C.ST.EX A	●	●	●	●	●	●	●
C.ST.EX B	●	●	●	●	●	●	●
C.ST.EX C	●	●	●	●	●	●	●
HALL	●	●	●	●	● ³⁾	●	●
JAZZ	●	●	●	●	● ³⁾	●	●
CONCERT	●	●	●	●	● ³⁾	●	●
PCM 96K ¹⁾	●						

¹⁾ "PCM 96K" appears as a sound field only for the digital input signals. In this case, other sound fields are unavailable.

²⁾ These parameters may not operate depending on the source or adjustments. For details, see each item in "Adjusting the level parameters" (page 24).

³⁾ When these sound fields are selected, there is no sound output from the sub woofer if the front speaker size is set to "LARGE". However, sound will be output from the sub woofer if the digital input signal contains LFE signals.