

**SONY**<sup>®</sup>

4-240-085-12 (1)

# ***Mini Hi-Fi Component System***

---

Operating Instructions



**Game SYNC**  
**M I X I N G**

***MHC-RV7***

© 2002 Sony Corporation

## WARNING

**To prevent fire or shock hazard, do not expose the unit to rain or moisture.**

To avoid electrical shock, do not open the cabinet. Refer servicing to qualified personnel only.

Do not install the appliance in a confined space, such as a bookcase or built-in cabinet.

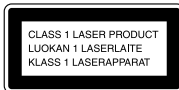

This appliance is classified as a CLASS 1 LASER product. The CLASS 1 LASER PRODUCT MARKING is located on the rear exterior.

To prevent fire, do not cover the ventilation of the apparatus with news papers, table-cloths, curtains, etc. And don't place lighted candles on the apparatus.

To prevent fire or shock hazard, do not place objects filled with liquids, such as vases, on the apparatus.



Don't throw away the battery with general house waste, dispose of it correctly as chemical waste.



ENERGY STAR® is a U.S. registered mark. As an ENERGY STAR® partner, Sony Corporation has determined that this product meets the ENERGY STAR® guidelines for energy efficiency.

## This system can play the following discs

	VIDEO CDs	Audio CDs
Disc logo		
Contents	Audio + Video (moving pictures)	Audio
Disc size	12 cm	12 cm
Play time	74 min.	74 min.

## Note on VIDEO CDs

This system conforms to VIDEO CDs without PBC\* functions (Ver. 1.1) and VIDEO CDs with PBC functions (Ver. 2.0) of VIDEO CD standards. You can enjoy two kinds of playback according to the disc type.

A VIDEO CD with CD audio tracks may not play properly.

Disc type	You can
VIDEO CDs without PBC functions (Ver. 1.1 discs)	Enjoy video playback (moving pictures) as well as audio CDs.
VIDEO CDs with PBC functions (Ver. 2.0 discs)	Play interactive software using menu screens displayed on the TV screen (menu playback), in addition to the video playback function of VIDEO CDs without PBC functions. Moreover, you can play high or standard quality still picture.

\* PBC = Play Back Control

## Notes on CD-R and CD-RW discs

This unit can play the following discs:

Type of discs	Label on the disc
Audio CDs	
MP3 files	

- Disc recorded in CD-R/CD-RW drives may not be played back because of scratches, dirt, recording condition or the drive's characteristics.
- You cannot play a CD-R/CD-RW that is not finalized\*.
- Playback of multi-session CD-Rs/CD-RWs is not supported.

\* A process necessary for a recorded CD-R/CD-RW disc to be played back on the audio CD player.

2<sup>GB</sup>

## Table of Contents

### List of Button Location and Reference Pages

Main unit .....	4
Remote Control .....	5

### Getting Started

Hooking up the system .....	6
Inserting two size AA (R6) batteries into the remote .....	8
Setting the clock .....	8

### VIDEO CD/CD/MP3 files

Loading a disc .....	9
Playing a VIDEO CD	
— Normal Play/Shuffle Play/Repeat Play .....	9
Playing a VIDEO CD with PBC functions (Ver.2.0)	
— PBC Playback .....	10
Playing a CD	
— Normal Play/Shuffle Play/Repeat Play .....	11
Programming the VIDEO CD/CD tracks	
— Program Play .....	12
Playing a disc with MP3 files .....	13
Locating a specific part of a disc on a VIDEO CD	
— Time search .....	15
— Disc Digest .....	15
Resuming playback from the point you stopped a VIDEO CD	
— Resume Play .....	16
Adjusting the picture	
— Picture effect .....	16

### Tuner

Presetting radio stations .....	17
Listening to the radio	
— Preset Tuning .....	17

### Tape

Loading a tape .....	18
Playing a tape .....	18
Recording to a tape	
— CD Synchro Recording/High Speed Dubbing/Recording Manually/Program Edit .....	19
Timer-recording radio programs .....	20

### Sound Adjustment

Adjusting the sound .....	22
Selecting the speaker system .....	22
Selecting the preset effect .....	22
Adjusting the graphic equalizer and storing the personal file .....	23
Selecting the cinema space effect .....	23

### Other Features

Changing the spectrum analyzer	
display .....	24
Adjusting the brightness of the display .....	24
Enhancing the video game sound	
— Game Sync .....	24
Mixing the sound	
— Game Mixing .....	24
Singing along: Karaoke .....	24
Mixing and recording sounds .....	25
Falling asleep to music	
— Sleep Timer .....	26
Waking up to music	
— Daily Timer .....	26

### Display

Turning off the display	
— Power Saving Mode .....	28
Using the display .....	28
Using the on screen display .....	29

### Hooking Up the Optional Components

Connecting an MD deck or VCR .....	30
Connecting a Video Game Player .....	30
Connecting external antennas .....	31

### Troubleshooting

Problems and remedies .....	32
Messages .....	34

### Additional Information

Precautions .....	35
Specifications .....	36
Glossary .....	38

3GB

## List of Button Location and Reference Pages

### How to use this page

Use this page to find the location of buttons and other parts of the system that are mentioned in the text.

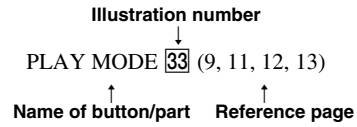

## Main unit

### ALPHABETICAL ORDER

#### A - D

ALBUM + 19 (12, 14)  
 ALBUM - 26 (12, 14)  
 CD 38 (7, 9-12, 14, 19)  
 CD SYNC HI-DUB 15 (19, 20)  
 CINEMA SPACE 42 (23)  
 DECK A 29 (18, 19)  
 DECK B 17 (18, 19)  
 DIMMER 9 (24)  
 DIRECTION 10 (18-20, 25)  
 DISC 1-3 4 (9-12, 14)  
 DISC SKIP EX-CHANGE 5 (10, 12, 14)  
 Disc tray 3 (9)  
 DISPLAY 7 (28)

#### E - J

ECHO LEVEL 21 (25)  
 EDIT 10 (20)  
 EFFECT ON/OFF 46 (22)  
 ENTER 44 (10, 11, 12, 16, 20, 21, 23, 26, 27)

#### K - Q

FM MODE 13 (17, 34)  
 GAME 34 (24, 30)  
 GAME EQ 47 (22, 30)  
 GAME INPUT (jacks) 25 (24, 30)  
 GAME MIXING 32 (19, 24)  
 GROOVE 48 (22)  
 IR (receptor) 2

KARAOKE PON 31 (25)  
 MD (VIDEO) 35 (30, 32)  
 MIC 23 (24, 25)  
 MIC LEVEL 22 (24, 25)  
 MOVIE EQ 41 (22)  
 MUSIC EQ 39 (22)  
 OPEN/CLOSE 6 (9, 10)  
 P FILE 43 (23)  
 PHONES (jack) 20 (32)  
 PLAY MODE 33 (9, 11, 12, 13)  
 PICTURE EFFECT 45 (16)

#### R - Z

REC PAUSE/START 16 (19, 20, 24, 25)  
 REPEAT 13 (10, 12, 14)  
 SPECTRUM 8 (24)  
 SHUTTLE 11 (10, 11, 14)  
 SURROUND SPEAKER MODE 30 (22)  
 TAPE A/B 36 (18, 19)  
 TUNER/BAND 37 (17)  
 TUNER MEMORY 33 (17)  
 VOLUME 12 (25, 32)

### BUTTON DESCRIPTIONS

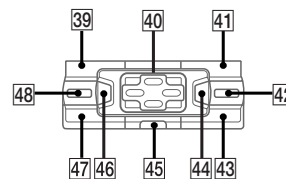
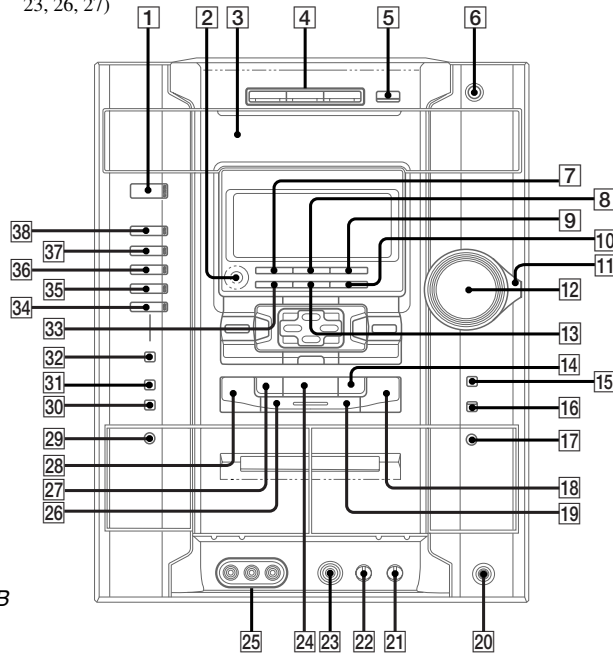
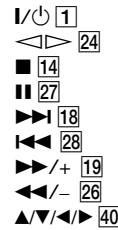

4 GB



## Getting Started

### Hooking up the system

Do the following procedure **1** to **6** to hook up your system using the supplied cords and accessories.

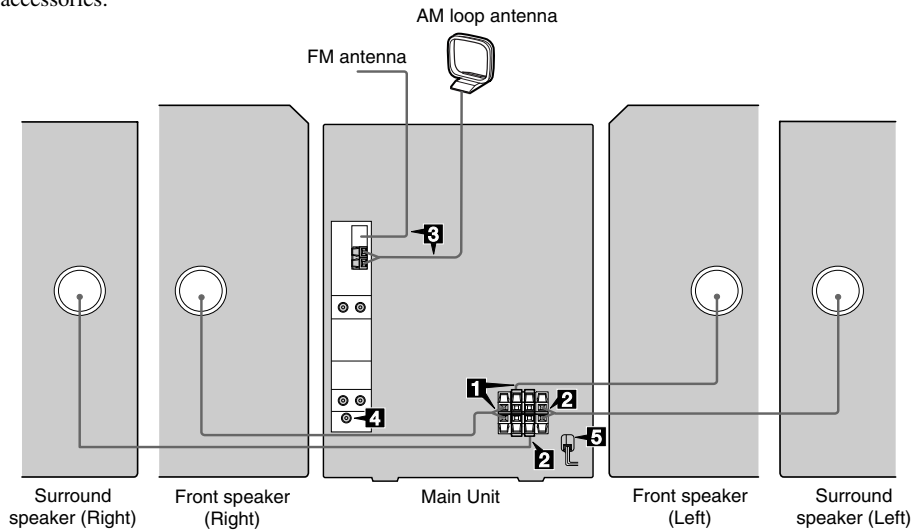

#### **1** Connect the front speakers.

Connect the speaker cords to the FRONT SPEAKER jacks.

Insert only the stripped portion. Red

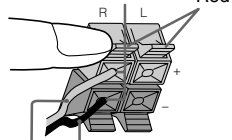

Red/Solid (⊕) Black/Stripe (⊖)

#### **2** Connect the surround speaker.

Connect the speaker cords to SURROUND SPEAKER jacks.

Insert only the stripped portion. Blue

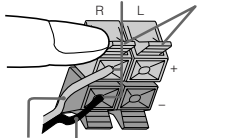

Blue/Solid (⊕) Black/Stripe (⊖)

#### **Note**

Keep the speaker cords away from the antennas to prevent noise.

#### **3** Connect the FM and AM antennas.

Set up the AM loop antenna, then connect it.

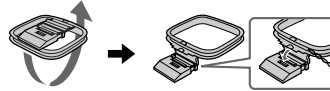

Extend the FM lead antenna horizontally.

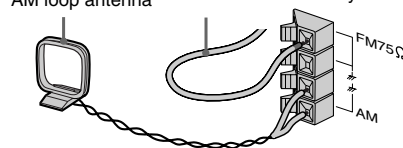

- 4** Connect the video input jack of your TV to the VIDEO OUT jack with the video cable.

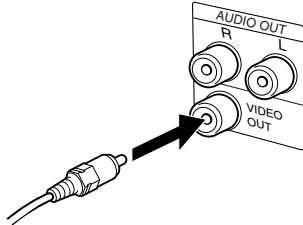

- 5** Connect the power cord to a wall outlet.

The demonstration appears in the display. When you press I/⏻, the system turns on and the demonstration automatically ends.

- 6** Set the color system according to your TV while the power is off.

The color system of your TV	Do this
NTSC	Press I/⏻ while holding down GAME EQ. The color system is set to NTSC.
PAL	Press I/⏻ while holding down MUSIC EQ. The color system is set to PAL.
AUTO*	Press I/⏻ while holding down MOVIE EQ. The color system is set to AUTO.

\* Your TV automatically changes the color system according to the input signal.

**To connect the optional components**

See page 30.

**To attach the speaker pads**

Attach the supplied speaker pads to the bottom of the speakers to stabilize the speakers and prevent them from slipping.

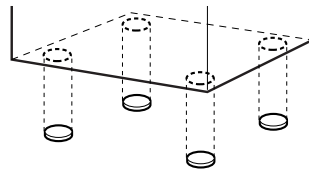

**Positioning the speakers**

Place the front speakers at an angle of 45 degrees from your listening position.

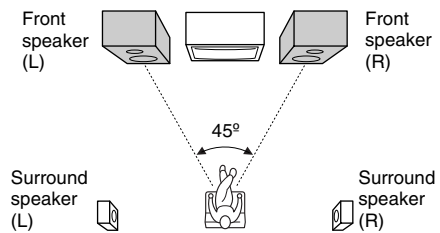

**Notice for carrying this system**

Do the following to protect the CD mechanism.

- 1 Make sure that all discs are removed from the unit.
- 2 Hold down CD and then press I/⏻ until "LOCK" appears.
- 3 Release I/⏻ first, then release CD.
- 4 Unplug the AC power cord.

Getting Started

## Inserting two size AA (R6) batteries into the remote

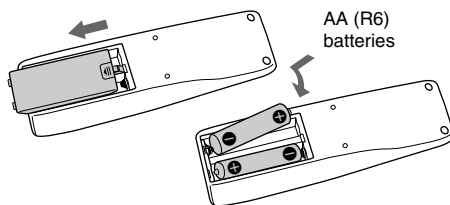

### Tip

With normal use, the batteries should last for about six months. When the remote no longer operates the system, replace both batteries with new ones.

### Note

If you do not use the remote for a long period of time, remove the batteries to avoid possible damage from battery leakage.

## Using the remote

You can control Sony TVs using the buttons below.

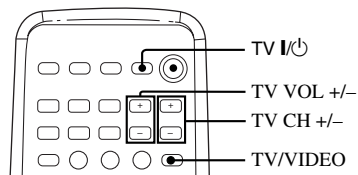

To	Press
turn the TV on or off	TV I/O
turn the TV's video input	TV/VIDEO
change the TV channel	TV CH +/-
adjust the volume of the TV	TV VOL +/-

### Note

Depending on the TV, you may not be able to control your TV or to use some of the buttons above.

## Setting the clock

- 1** Turn on the system.
- 2** Press **CLOCK/TIMER SET** on the remote.  
When you set the time for the first time, proceed to step 5.
- 3** Press **▼** or **▲** repeatedly to select **CLOCK SET**.
- 4** Press **ENTER**.
- 5** Press **▼** or **▲** repeatedly to set the hour.
- 6** Press **ENTER**.
- 7** Press **▼** or **▲** repeatedly to set the minute.
- 8** Press **ENTER**.  
The clock starts functioning.

### Tip

If you have made a mistake or want to change the time, start over from step 2.

### Note

The clock settings are cancelled when you disconnect the power cord or if a power failure occurs.



## VIDEO CD/CD/MP3 files

### Loading a disc

- 1 Press **OPEN/CLOSE**  $\blacktriangle$ .  
The CD compartment slides out.
- 2 Place a disc with the label side up on the disc tray.

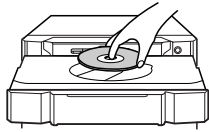

To insert additional discs, press **DISC SKIP EX-CHANGE** to rotate the disc tray.

- 3 Press **OPEN/CLOSE**  $\blacktriangle$  to close the CD compartment.

### Playing a VIDEO CD

#### — Normal Play/Shuffle Play/Repeat Play

You can play both VIDEO CDs without PBC functions (Ver. 1.1) and VIDEO CDs with PBC functions (Ver. 2.0).

This unit lets you play the VIDEO CD in different play modes.

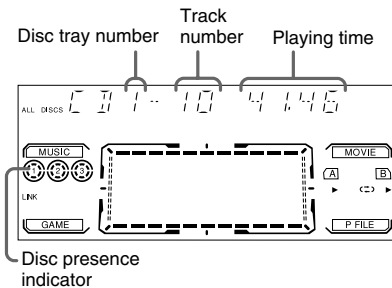

- 1 Turn on your TV and select the video input.  
Refer to the operating instructions supplied with your TV if you need help.
- 2 Press **CD**.

- 3 When playback is stopped, press **PLAY MODE** repeatedly until the mode you want appears in the display.

Select	To play
ALL DISCS* (Normal Play)	All VIDEO CDs in the disc tray continuously.
1 DISC/ALBUM (Normal Play)	The VIDEO CD you have selected in the original order.
SHUFFLE ALL DISCS (Shuffle Play)	The tracks on all VIDEO CDs in random order.
SHUFFLE 1 DISC/SHUFFLE ALBUM (Shuffle Play)	The tracks on the VIDEO CD you have selected in random order.
PROGRAM (Program Play)	The tracks on all VIDEO CDs in the order you want them to be played (see "Programming the VIDEO CD/CD tracks" on page 12).

\* Depending on VIDEO CDs with PBC function (Ver. 2.0), the disc does not change.

- 4 Press  $\blacktriangleleft \blacktriangleright$ .

#### Tip

You cannot change the play mode during playback.

### Other Operations

To	Do this
Stop playback	Press $\blacksquare$ .
Pause playback	Press $\mathbb{I}$ *1. Press again to resume playback.
Select a track or scene*2	Press $\blacktriangleright$ to go forward and $\blacktriangleleft$ to go backward. When you play VIDEO CDs with PBC functions (Ver 2.0), see page 10.

continued

## Playing a VIDEO CD (continued)

To	Do this
Find a point in a track or scene	There are two types of searching: ① Manual Search During playback, turn SHUTTLE clockwise (to go forward) or counter clockwise (to go backward) until it clicks and hold it. Release SHUTTLE when you reach the point you want. ② Lock Search During playback, press ►► or ◀◀. Each time you press the button, speed changes as follows: 1 (low) → 2 (normal) → 3 (high) → 1 (low) ... Press ◀◀ to stop searching and start playback at the point you want.
Select a VIDEO CD when playback is stopped	Press one of the DISC 1~3 buttons (except SHUFFLE ALL DISCS mode) or DISC SKIP EX-CHANGE (or D. SKIP on the remote).
Switch to CD function from another source	Press CD or one of the DISC 1~3 (Automatic Source Selection).
Play repeatedly (Repeat Play)	Press REPEAT repeatedly to select "REPEAT" <sup>*3</sup> or "REPEAT 1" <sup>*2*4</sup> .
Cancel Repeat Play	Press REPEAT until "REPEAT" or "REPEAT 1" disappears from the display.
Exchange other VIDEO CDs while playing	Press DISC SKIP EX-CHANGE.
Remove the VIDEO CD	Press OPEN/CLOSE ▲.

<sup>\*1</sup> There may be some disturbance in the video image.

<sup>\*2</sup> Only when PBC function is set to off or when playing VIDEO CDs without PBC functions (Version 1.1).

<sup>\*3</sup> All the tracks repeated up to five times. You cannot use this function during SHUFFLE ALL DISCS.

<sup>\*4</sup> To repeat the current track you are playing.

### Tip

Pressing the CD while the power is off automatically turns the power on and CD is selected as the function (except for the Power Saving Mode).

## Playing a VIDEO CD with PBC functions (Ver. 2.0)

### — PBC Playback

You can use menus on your TV screen to enjoy the disc's interactive software. The menu format and structure may differ with each disc.

#### 1 Press CD.

#### 2 Press ◀◀ to start playing a VIDEO CD with PBC functions (Ver. 2.0).

The VIDEO CD and PBC indicators light up and a PBC menu appears in your TV.

- VCD : Lights up during playback of a VIDEO CD.
- PBC : Lights up during PBC playback of a PBC compatible VIDEO CD (Ver. 2.0).
- PBC OFF : Lights up when a PBC compatible VIDEO CD (Ver. 2.0) is played without using the PBC functions.

#### 3 Press ◀◀ or ►► repeatedly to select a number from the menu, then press ENTER (press SELECT or press the numeric buttons on the remote).

#### 4 Continue playback according to the instructions on the menus to enjoy interactive playback.

To	Do this
Stop playback	Press ■.
Go to the next menu page or scene	Press NEXT on the remote.
Go back to the previous menu page or scene	Press PREV on the remote.
Go back to the previous menu	Press RETURN ↶ on the remote.
Cancel playback with PBC function (Ver 2.0)	When the playback is stopped, press ◀◀ or ►► repeatedly to select the track you want, then press ENTER (or press numeric buttons on the remote). The PBC OFF indicator lights up and playback starts from the selected track. Still images, such as the menu screens will not be shown.

To	Do this
Playback with PBC function (Ver. 2.0) after cancelling the playback with PBC function	Press ◀▶ when the playback is stopped.
Select a menu number using the remote	Press the numeric buttons on the remote. To enter menu number 11 or above, first press > 10, then press numeric buttons. To enter 0, use the 10/0. For example, to enter track number 30, press > 10, then 3 and 10/0.

**Tips**

- When  appears on the TV screen, you have pressed an invalid button. Press a button indicated by the instructions on the menu screen.
- When you press NEXT on the remote during menu playback or while playing moving pictures, the next scene on the disc appears. Refer to the instructions supplied with the disc.

## Playing a CD

### —Normal Play/Shuffle Play/Repeat Play

This unit lets you play a disc in different play modes.

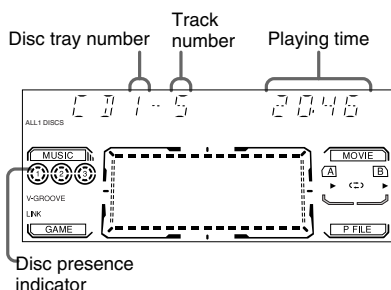

**1 Press CD.**

**2 When playback is stopped, press PLAY MODE repeatedly until the mode you want appears in the display.**

Select	To play
ALL DISCS (Normal Play)	All CDs in the disc tray continuously.
1 DISC/ALBUM (Normal Play)	The CD you have selected in the original order.

Select	To play
SHUFFLE ALL DISCS (Shuffle Play)	The tracks on all CDs in random order.
SHUFFLE 1 DISC/SHUFFLE ALBUM (Shuffle Play)	The tracks on the CD you have selected in random order.
PROGRAM (Program Play)	The tracks on all CDs in the order you want them to be played (see "Programming the VIDEO CD/CD tracks" on page 12).

**3 Press ◀▶.**

**Tip**

You cannot change the play mode during playback.

## Other Operations

To	Do this
Stop playback	Press ■.
Pause playback	Press II. Press again to resume playback.
Select a track	During playback or pause, press ►► (to go forward) or ◀◀ (to go backward).
Find a point in a track	There are two types of searching: ① Manual Search During playback, turn SHUTTLE clockwise (to go forward) or counter clockwise (to go backward) until it clicks and hold it. Release SHUTTLE when you reach the point you want. ② Lock Search During playback, press ►► or ◀◀. Press ◀▶ to stop searching and start playback at the point you want.

continued

### Playing the CD (continued)

To	Do this
Select a CD when playback is stopped	Press one of the DISC 1~3 buttons (except SHUFFLE ALL DISCS mode) or DISC SKIP EX-CHANGE (or D. SKIP on the remote).
Switch to CD function from another source	Press CD or one of the DISC 1~3 buttons (Automatic Source Selection).
Play repeatedly (Repeat Play)	Press REPEAT repeatedly to select "REPEAT" <sup>*1</sup> or "REPEAT 1" <sup>*2</sup> .
Cancel Repeat Play	Press REPEAT until "REPEAT" or "REPEAT 1" disappears from the display.
Exchange other CDs while playing	Press DISC SKIP EX-CHANGE.
Remove the CD	Press OPEN/CLOSE ▲.

<sup>\*1</sup> All the tracks repeated up to five times.  
You cannot use this function during SHUFFLE ALL DISCS.

<sup>\*2</sup> To repeat the current track you are playing.

#### Tip

Pressing the CD while the power is off automatically turns the power on and CD is selected as the function (except for the Power Saving Mode).

## Programming the VIDEO CD/CD tracks

### — Program Play

You can make a program of up to 25 tracks from all the VIDEO CD/CDs in the order you want them to be played.

- 1 Press CD.
- 2 Press PLAY MODE repeatedly until "PROGRAM" appears in the display.
- 3 Press one of the DISC 1~3 to select a CD.

- 4 Press ◀◀ or ▶▶ repeatedly until the track you want appears in the display.

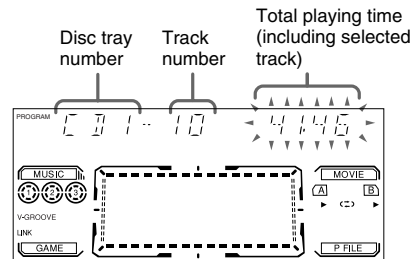

- 5 Press ENTER.

The track is programmed. The program step number appears, followed by the total playing time.

- 6 To program additional tracks, repeat steps 3 to 5.

Skip step 3 to select tracks from the same disc.

- 7 Press ◀▶.

### Other Operations

To	Do this
Cancel Program Play	Press PLAY MODE repeatedly until "ALL DISCS", "1 DISC" or "ALBUM" appears in the display.
Clear a track from the end	Press CLEAR on the remote when playback is stopped.
Add a track to the program when playback is stopped	<ol style="list-style-type: none"> <li>1 Press one of the DISC 1~3 buttons to select a CD.</li> <li>2 Press ◀◀ or ▶▶ repeatedly to select the track.</li> <li>3 Press ENTER.</li> </ol>

#### To program the MP3 files

After step 3, press ALBUM +/- repeatedly until the folder you want appears, then go to step 4.

#### Tips

- The program you made remains in the system's memory even after it has been played back. Press ◀▶ to play the same program again.
- If "--.--" appears instead of the total playing time during programming, this means:
  - you have programmed a track number which exceeds 20.
  - the total playing time has exceeded 100 minutes.
  - you have programmed a MP3 files.

## Playing a disc with MP3 files

### About MP3 files

MP3 (MPEG 1 Audio Layer-3) is a standard technology and format for compressing a sound sequence. The file is compressed to about 1/10 of its original size. Sounds outside the range of human hearing are compressed while the sounds we can hear are not compressed.

### Notes on discs

You can play MP3 files recorded on CD-ROMs, CD-Rs (recordable CDs), and CD-RWs (rewritable CDs).

The disc must be in the ISO 9660\* level 1 or level 2 format.

#### \* ISO 9660 Format

The most common international standard for the logical format of files and folders on a CD-ROM. There are several specification levels. In Level 1, file names must be in the 8.3 format (no more than eight characters in the name, no more than three characters in the extension “.MP3”) and in capital letters. Folder names can be longer than eight characters. There can be no more than eight nested folder levels. Level 2 specifications allow file names and folder names up to 31 characters long.

### —Normal Play/Shuffle Play/Repeat Play

This unit lets you play a disc with MP3 files in different play modes.

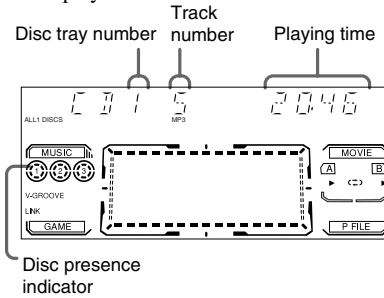

#### 1 Press CD.

#### 2 When playback is stopped, press PLAY MODE repeatedly until the mode you want appears in the display.

Select	To play
ALL DISCS (Normal Play)	All discs in the disc tray continuously.
1 DISC (Normal Play)	The disc you have selected in the original order.
ALBUM (Normal Play)	The folder you have selected in the original order.
SHUFFLE ALL DISCS (Shuffle Play)	The files on all discs in random order.
SHUFFLE 1 DISC (Shuffle Play)	The files on the discs you have selected in random order.
SHUFFLE ALBUM (Shuffle Play)	The files in the folder you have selected in the random order.
PROGRAM (Program Play)	The tracks on all discs in the order you want them to be played (see “Programming the VIDEO CD/CD tracks” on page 12).

#### 3 Press ◀▶.

continued

**Playing a disc with MP3 files  
(continued)**

**Other Operations**

To	Do this
Stop playback	Press ■.
Pause playback	Press II. Press again to resume playback.
Select a file	During playback or pause, press ►► (to go forward) or ◀◀ (to go backward).
Select a folder <sup>*1</sup>	Press ALBUM +/- after step 2.
Find a point in a file <sup>*2</sup>	There are two type of searching: ① Manual Search During playback, turn SHUTTLE clockwise (to go forward) or counter clockwise (to go backward) until it clicks and hold it. Release SHUTTLE when you reach the point you want. ② Lock Search During playback, press ◀◀ or ►► on the remote. Press ◀◀►► to stop searching and start playback at the point you want.
Select a disc when playback is stopped	Press one of the DISC 1~3 buttons (except SHUFFLE ALL DISCS mode) or DISC SKIP EX-CHANGE (or D. SKIP on the remote).
Switch to CD function from another source	Press CD or one of the DISC 1~3 buttons (Automatic Source Selection).
Play repeatedly (Repeat Play)	Press REPEAT repeatedly to select "REPEAT" <sup>*3</sup> or "REPEAT 1" <sup>*4</sup> .
Cancel Repeat Play	Press REPEAT until "REPEAT" or "REPEAT 1" disappears from the display.
Exchange other discs while playing	Press DISC SKIP EX-CHANGE.
Remove the disc	Press OPEN/CLOSE ▲.

<sup>\*1</sup> You cannot select a folder during SHUFFLE ALL DISCS and SHUFFLE 1 DISC.

<sup>\*2</sup> The search function works only for currently playing MP3 file. Searching for a point over two or more MP3 files is therefore not possible. Furthermore, the playing time may not be displayed correctly depending on the MP3 file.

<sup>\*3</sup> All the tracks repeated up to five times. You cannot use this function during SHUFFLE ALL DISCS.

<sup>\*4</sup> To repeat the current track you are playing.

**Tips**

- To select a file number using the remote, press numeric buttons after step 3.  
Example:  
If the folder contains 100 files or more, to play file number 100, press >10, then 1, and 10/0 twice.
- Pressing the CD while the power is off automatically turns the power on and CD is selected as the function (except for Power Saving Mode).

**Notes**

- With formats other than ISO 9660, folder names or file names may not be displayed correctly.
- When naming, be sure to add the file extension ".MP3" to the file name.
- If you save up the extension ".MP3" to a file other than MP3 files, the unit cannot recognize the file properly and will generate random noise that could damage your speakers.
- You are recommended not to save another types of files or unnecessary folders on a disc that has MP3 files.
- The disc recorded with complicated tree structure take longer time to start playback.
- When the disc is inserted, the player reads all the files in that disc. If there are many folders or non MP3 files on the disc, it may takes longer time for playback to begin or for next MP3 files to start playback.
- A folder that does not include an MP3 file is skipped.
- Maximum folder number: 255 (The maximum number of MP3 files and folders that can be contained on a single disc is 512.)
- Playback is possible up to 8 levels.
- Playback follows the recorded order of folders and files on a disc.
- There may be an exception to these rules depending on a disc.
- Depending on the encoding/writing software, recording device, or the recording media used at the time an MP3 file is recorded, you may encounter problem such as cannot playback, sounds interruptions, and noise.

## Locating a specific part of a disc on a VIDEO CD

### — Time Search/Disc Digest

Before using these functions, make sure to turn on your TV screen.

Use the remote for the operation.

#### To use special menu with VIDEO CDs with PBC functions (Ver. 2.0)

Cancel the PBC function (see “Cancel playback with PBC function” on page 10).

#### To enter the time or track number with the remote

Press the numeric buttons.

#### To stop playback

Press ■.

## Locating by elapsed time from the beginning of the disc on a VIDEO CD

### — Time Search

- 1** Press **SPECIAL MENU** when the playback is stopped.
- 2** Press **1** to select “**1**) TIME SEARCH.”
- 3** Press the numeric buttons to enter the time (in minutes) for the section you want.  
The selected elapsed time appears on the TV screen.  
To re-enter the time: Press **CLEAR**, and then press numeric buttons again.
- 4** Press ◀▶.

Playback starts from the selected time.

## Locating the track you want on a disc

### — Disc Digest

You can select the track you want by viewing the first frame of each track. Nine different tracks can be displayed on the TV screen at one time.

- 1** Press **SPECIAL MENU** when the playback is stopped.
- 2** Press **2** to select “**2**) DISC DIGEST.”  
The first frame of tracks 1 through 9 on the current disc are displayed.
- 3** Press the numeric buttons (**1 – 9**) to select the track you want.  
Playback starts from a point near the selected frame.

#### To display the next 9 tracks

Press **NEXT** or ▶▶. The first frame of tracks 10 through 18 are displayed.

When there are more tracks in the disc, “▶▶▶” appears in the upper right corner of the TV screen.

To display previous tracks, press **PREV** or ◀◀.

## Resuming playback from the point you stopped a VIDEO CD

### — Resume Play

The unit memorizes the point where you stopped the VIDEO CD so you can resume from that point.

Resume Play is not available for an audio CD and a disc with MP3 files.

**1** While playing a VIDEO CD, press **■** to stop playback.

“RESUME” appears on your TV screen. If “RESUME” does not appear, Resume Play is not available.

**2** Press **<▶>**.

The player starts playback from the point you stopped the VIDEO CD in step 1.

### To view from the beginning of the VIDEO CD

When “RESUME” appears in the display, press **■**, then press **<▶>**.

#### Notes

- Resume Play is not available in the Shuffle or Program Play modes.
- Depending on where you stopped the VIDEO CD, the player may resume playback from a different point.
- Resume play is cancelled when:
  - you press numeric buttons, PLAY MODE, **■**, DISC SKIP EX-CHANGE (or D. SKIP on the remote) or **◀◀/▶▶**.
  - you remove the VIDEO CD.
  - you turn off the system.
  - you change the function.

## Adjusting the picture

### — Picture Effect

You can adjust the hue and sharpness of the picture while playing a VIDEO CD.

**1** Press PICTURE EFFECT.

**2** Press **◀** or **▶** repeatedly to adjust the hue.

**3** Press **▲** or **▼** repeatedly to adjust the sharpness.

**4** Press ENTER or PICTURE EFFECT.

#### Tip

The hue and sharpness can be adjusted in 11 steps (from -5 to +5).



## Tuner

### Presetting radio stations

You can preset 20 stations for FM and 10 stations for AM.

- 1 Press **TUNER/BAND** repeatedly to select **FM** or **AM**.
- 2 Press and hold **▶▶** or **◀◀** (or **TUNING +/-** on the remote) until **"AUTO"** appears in the display and the frequency indication starts to change, then release.

Scanning stops when the system tunes in a station. **"TUNED"** and **"STEREO"** (for a stereo program) appear.



- 3 Press **TUNER MEMORY**.

A preset number appears in the display.

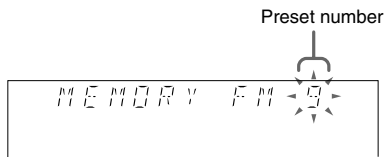

- 4 Press **◀◀** or **▶▶** to select the preset number you want to store.
- 5 Press **ENTER**.  
**"COMPLETE"** appears in the display.  
The station is stored.
- 6 Repeat steps 1 to 5 to store other stations.

#### To tune in a station with a weak signal (Manual Tuning)

Press **▶▶** or **◀◀** (**TUNING +/-** on the remote) repeatedly to tune in the station manually.

#### To change the AM tuning interval

The factory setting for AM tuning interval is 9 kHz (10 kHz in some areas). To change the AM tuning interval, select any AM station first, then turn off the power. While holding down the **ENTER** button, turn the power back on. When you change the interval, AM preset stations will be erased. To reset the interval, repeat the same procedure.

#### Tips

- The preset stations are retained for half a day even if you unplug the power cord or if a power failure occurs.
- Pressing **TUNER/BAND** while the power is off automatically turns the power on and **TUNER** is selected as the function (except for the Power Saving Mode).

### Listening to the radio

#### — Preset Tuning

Preset radio stations in the tuner's memory first (see "Presetting radio stations").

- 1 Press **TUNER/BAND** repeatedly to select **FM** or **AM**.
- 2 Press **◀◀** or **▶▶** (or press **PRESET +/-** on the remote) to tune in the preset station you want.

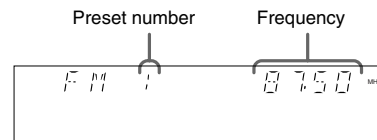

#### To listen to non-preset radio stations

Press **▶▶** or **◀◀** (or **TUNING +/-** on the remote) repeatedly (Manual Tuning) or press and hold **▶▶** or **◀◀** (or **TUNING +/-** on the remote) (Automatic Tuning).

#### Tips

- When an FM program is noisy, press **FM MODE** so that **"MONO"** appears in the display. There will be no stereo effect, but the reception will improve.
- To improve broadcast reception, reorient the antennas.

## Tape

### Loading a tape

- 1 Press **TAPE A/B** repeatedly to select **Deck A or B**.
- 2 Press **▲** on the selected deck.
- 3 Insert a tape in deck A or B.

Insert with the side you want to play/record facing forward.

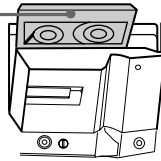

### Playing a tape

- 1 Load a tape.
- 2 Press **DIRECTION** repeatedly to select **→** to play one side, **↔** to play both sides or **RELAY\*** (Relay Play) to play both decks in succession.
- 3 Press **▶◀**. The tape starts playing.  
Press **◀▶** again to play the reverse side.

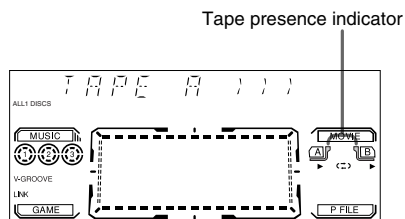

\* Relay Play always follow this cyclic sequence:  
Deck A (front side) → Deck A (reverse side) →  
Deck B (front side) → Deck B (reverse side)

To	Do this
Stop playback	Press <b>■</b> .
Pause playback	Press <b>  </b> . Press again to resume playback.
Fast-forward	Press <b>▶▶</b> while playing the front side, or press <b>◀◀</b> while playing the reverse side.
Rewind	Press <b>◀◀</b> while playing the front side, or press <b>▶▶</b> while playing the reverse side.

#### Tips

- During **↔** or Relay Play, the deck stops automatically after repeating the sequence five times.
- Pressing **TAPE A/B** while the power is off automatically turns the power on and **TAPE** is selected as the function (except for Power Saving Mode).
- When a tape (tapes) is (are) inserted, corresponding presence indicators light up.

#### Searching for the beginning of a track (AMS\*)

During playback, press **◀◀** or **▶▶** repeatedly for the number of songs you want to skip forward (or backward).

The search direction, + (forward) or - (backward), and number of songs being skipped (1~9) appear in the display.

Example: searching forward 2 songs

TAP E A 1 1 1 + 2

\* AMS (Automatic Music Sensor)

#### Note

The AMS function may not operate correctly under the following circumstances:

- When the unrecorded space between songs is less than 4 seconds long.
- When the unit is placed near a television.

## Recording to a tape

### — CD Synchro Recording/High Speed Dubbing/Recording Manually/ Program Edit

You can record from a VIDEO CD/CD/a disc with MP3 files, tape, radio or other connected component. The recording level is adjusted automatically.

Steps	Recording from a disc (CD Synchro Recording)	Recording from a tape (High-Speed Dubbing)	Recording Manually
<b>1</b>	Insert a recordable tape into deck B.		
<b>2</b>	Press CD.	Press TAPE A/B repeatedly to select TAPE A.	Press a function button for the recording source.
<b>3</b>	Load the CD you want to record.	Load the tape you want to record into deck A.	Load the CD or tape (or other audio sources), or tune to the station you want to record.
<b>4</b>	Press CD SYNC HI-DUB.		Press REC PAUSE/START.
	DECK B standby for recording. REC PAUSE/START indicator flashes.		
<b>5</b>	Press DIRECTION repeatedly to select $\rightleftarrows$ to record on one side. Select $\leftrightarrow$ (or RELAY) to record on both sides.		
<b>6</b>	Press REC PAUSE/START. If you are recording manually, press $\triangleleft \triangleright$ to start playing the source (for CD or Tape). Recording starts.		
<b>7</b>	Press ■ to stop recording.		

Tape

#### Tips

- When you record on both sides, be sure to start from the front side. If you start from the reverse side, recording stops at the end of the reverse side.
- For recording from the reverse side:  
After step 1, press TAPE A/B to select deck B and press  $\triangleleft \triangleright$  twice to start playback of the reverse side. Press ■ at the point where you want to start recording. The TAPE B reverse side indicator lights up.
- (High-Speed Dubbing only)  
If you set direction to  $\leftrightarrow$  when the tapes you use have different lengths, the tapes in each deck reverse independently. If you select RELAY, the tapes in both decks reverse together.
- For recording from the radio:  
If noise is heard while recording from the radio, move the respective antenna to reduce the noise.

- For recording from a CD to a tape manually:  
You can press  $\blacktriangleleft \blacktriangleright$  or  $\blacktriangleright \blacktriangleleft$  to select tracks during recording pause mode (after step 4 and before step 6).
- You can mix the sound from the component connected to the GAME INPUT jacks with another function such as CD, tape, radio or an MD connected to this system. To record the mixed sound, press GAME MIXING after step 4 of "Recording Manually" and then press REC PAUSE/START to start recording. Game Mixing does not function during High-Speed Dubbing and CD Synchro Recording.

#### Note

You cannot listen to other sources while recording.

continued

19<sup>GB</sup>

## Recording to a tape (continued)

### Recording a CD by specifying track order

#### — Program Edit

You can record tracks from all the CDs in the order you want. When programming, make sure the playing times for each side do not exceed the length of one side of the tape.

- 1 Insert a recordable tape into deck B, then press CD.**
- 2 Program the VIDEO CD/CD tracks following step 1 to 6 in “Programming the VIDEO CD/CD tracks” on page 12.**
- 3 Press CD SYNC HI-DUB.**  
Deck B standby for recording. The REC PAUSE/START indicator flashes.
- 4 Press DIRECTION repeatedly to select  $\rightleftarrows$  to record on one side. Select  $\leftrightarrow$  (or RELAY) to record on both sides.**
- 5 Press REC PAUSE/START.**  
Recording starts.

#### To record a disc with MP3 files by specifying file order

After step 1, program the MP3 files following the procedures in “To program the MP3 files” on page 12, then proceed to step 3 above.

#### Tip

To check the required tape length for recording a CD, press EDIT after you have loaded a CD in CD function. The required tape length for the currently selected CD appears, followed by the total playing time for side A and side B respectively (Tape Select Edit).

#### Note

You cannot use Tape Select Edit for discs containing over 20 tracks or MP3 files.

## Timer-recording radio programs

To timer-record, you must preset the radio station (see “Presetting radio stations” on page 17) and set the clock (see “Setting the clock” on page 8) beforehand.

- 1 Tune in the preset radio station (see “Listening to the radio” on page 17).**
- 2 Press CLOCK/TIMER SET on the remote.**  
“DAILY1 SET” appears.
- 3 Press  $\blacktriangledown$  or  $\blacktriangle$  repeatedly to select “REC SET”, then press ENTER.**  
“ON” appears and the hour indication flash in the display.
- 4 Set the time to start recording.**  
Press  $\blacktriangledown$  or  $\blacktriangle$  repeatedly to set the hour, then press ENTER.  
The minute indication starts flashing.  
Press  $\blacktriangledown$  or  $\blacktriangle$  repeatedly to set the minute, then press ENTER.  
The hour indication flashes again.
- 5 Set the time to stop recording following the above procedure.**  
The start time appears, followed by the stop time, the preset radio station to be recorded (e.g., “TUNER FM 5”), then the original display appears.
- 6 Insert a recordable tape into deck B.**  
Make sure the tape is in forward direction.
- 7 Turn off the power.**  
When the recording starts, the volume level is set to the minimum.

To	Do this
Check the setting	Press CLOCK/TIMER SELECT on the remote and press ▼ or ▲ repeatedly to select "REC SEL". Then, press ENTER.
Change the setting	Start from step 1.
Cancel timer operation	Press CLOCK/TIMER SELECT on the remote and press ▼ or ▲ repeatedly to select "TIMER OFF". Then, press ENTER.

**Notes**

- If you turn on the power before the preset time, Timer Recording will not function.
- The power turns on 15 seconds before the preset time.



**Tape**

## Sound Adjustment

### Adjusting the sound

You can reinforce the bass and create a more powerful sound.

#### Press GROOVE.

Each time you press this button, the display changes cyclically as follows:

V-GROOVE → GROOVE → GROOVE OFF

#### V-GROOVE

The volume switches to power mode, the low bass frequencies are powerfully reinforced, and the equalizer curve changes.

#### GROOVE

The volume switches to power mode and the equalizer curve changes.

### Selecting the speaker system

You can enjoy different sounds when you select the surround speaker mode.

**Press SURROUND SPEAKER MODE to select the surround speaker mode you want.**

LINK : Reproduces the same sound with the different output level.

MATRIX SUR : Reproduces a wide range of sound that actually can sense the size of the room.

### Selecting the preset effect

**Press MUSIC EQ, MOVIE EQ or GAME EQ (or PRESET EQ on the remote) repeatedly to select the preset effect you want.**

The preset effect name appears in the display. See the chart "Preset effect options".

#### To cancel the effect

**Press EFFECT ON/OFF repeatedly until "EFFECT OFF" appears.**

#### Preset effect options

"CINEMA SPACE" indicator appears if you select a preset effect with cinema space effect.

MENU button	Effect	For
MUSIC EQ	ROCK POP JAZZ DANCE SOUL ORIENTAL*	standard music sources.
MOVIE EQ	ACTION DRAMA MUSICAL	soundtracks and special listening situations.
GAME EQ	ARCADE RACING ADVENTURE	Play station 1, 2 and other video game music sources.

\* CLASSIC for Latin American models only.

## Adjusting the graphic equalizer and storing the personal file

You can adjust the sound by raising or lowering the level of specific frequency band, then store up to three personal files (P FILE) in the memory.

Before operation, select the preset effect you want for your basic sound.

- 1 Press ◀ or ▶ repeatedly to select a frequency band or cinema space, then press ▲ or ▼ to adjust the level or select the cinema space effect.

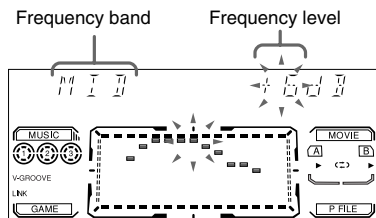

- 2 Press and hold P FILE until the personal file number appears in the display.

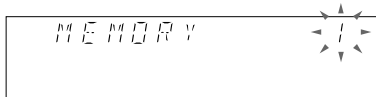

- 3 Press ▲ or ▼ or ▶ or ◀ to select the personal file number (P FILE) where you want to store the equalizer setting.
- 4 Press ENTER.

The setting is automatically stored as the personal file you selected in step 3. The previous setting stored at this memory location is erased and replaced by the new setting.

### To call up the personal file

Press P FILE repeatedly until the personal file number you want appears in the display.

#### Tip

If you do not want to store a personal file, press ENTER after step 1.

## Selecting the cinema space effect

### Press CINEMA SPACE.

Each time you press the button, the display changes cyclically as follows:

C.SPACE LOW → C.SPACE MID  
→ C.SPACE HIGH → C.SPACE OFF

#### Note

When you choose other sound effects, the cinema space effect may be cancelled.

## Other Features

### Changing the spectrum analyzer display

**Press SPECTRUM.**

Each time you press the button, the display changes cyclically as follows:

SPECTRUM 1 → SPECTRUM 2 →  
SPECTRUM 3 → PATTERN 1 →  
PATTERN 2 → PATTERN 3 →  
PATTERN OFF

### Adjusting the brightness of the display

**Press DIMMER.**

Each time you press the button, the display changes cyclically as follows:

DIMMER 1 → DIMMER 2 → DIMMER 3

### Enhancing the video game sound

#### — Game Sync

You need to connect a video game player (see “Connecting a Video Game Player” on page 30).

**Press GAME.**

**Tips**

- Pressing GAME while the power is off automatically turns the power on and game is selected as the function (except for Power Saving Mode).
- The previously selected GAME EQ is automatically selected.

### Mixing the sound

#### — Game Mixing

You can mix the sound from the component connected to the GAME INPUT jacks with another function such as CD, tape, radio or an MD connected to this system.

**1 Select source sound you want.**

**2 Press GAME MIXING.**

Each time you press the button, the level of the game sound and the display changes cyclically as follows:

MIXING LOW → MIXING MID →  
MIXING HIGH → MIXING OFF

**Tips**

- To record the mixed sound, press GAME MIXING after step 4 of “Recording Manually” on page 19 and then press REC PAUSE/START to start recording.
- The GAME MIXING indicator lights up while Game Mixing is activated and it will remain active while the power is on even if the function is changed.

**Notes**

- If you press GAME MIXING during VCD playback, the TV screen will display the video image from the component connected to the GAME INPUT jacks.
- Game Mixing is cancelled when you press REC PAUSE/START.
- Game Mixing does not function during High Speed Dubbing and CD Synchro Recording.

### Singing along: Karaoke

You can sing along with any stereo CD by turning down the singer’s voice. You need to connect an optional microphone.

**1 Turn MIC LEVEL to MIN to turn down the microphone volume.**

**2 Connect an optional microphone to MIC jack.**



### 3 Press KARAOKE PON.

Each time you press the button, the display changes cyclically as follows:

KARAOKE PON → MPX R → MPX L  
→ KARAOKE OFF

The “” indicator appears in the display when a karaoke mode is activated.

To sing karaoke by decreasing the vocal level of the music source, select “KARAOKE PON”.

To sing karaoke of multiplex CD select “MPX R” or “MPX L”.

### 4 Start playing the music and adjust the volume.

### 5 Adjust the microphone volume by turning MIC LEVEL.

To	Do this
Use VIDEO CDs	Turn on your TV and select the video input.
Cancel karaoke mode	Turn MIC LEVEL to MIN, disconnect the microphone from MIC jack, then press KARAOKE PON repeatedly until “  ” disappears.
Adjust the microphone echo	Turn ECHO LEVEL to adjust the echo effect. To cancel the echo effect, turn ECHO LEVEL to MIN.
Adjust the key (For VCD/audio CD only)	Press KEY CONTROL # or <b>b</b> on the remote to suit your vocal range. You can adjust the key higher or lower in 13 half-tone steps ( <b>b6 ~ #6</b> ).

### Notes

- With some songs, vocals may not be cancelled when you select “KARAOKE PON”.
- During KARAOKE PON, the equalizer and cinema space effect settings cannot be changed.
- If you press EFFECT ON/OFF or recall a sound effect, the karaoke mode is canceled.
- The instrumental sound may be reduced as well as the singer’s voice when the sound is recorded in monaural.
- Karaoke can be used during CD function only.
- The singer’s voice may not be reduced when:
  - only a few instruments are playing.
  - a duet is being played.
  - the source has strong echoes or chorus.
  - the singer’s voice deviates from the center.
  - the voice on the source is singing in high soprano or tenor.

## Mixing and recording sounds

You can “mix” sounds by playing one of the components and singing or speaking into a microphone.

The mixed sound can be recorded on a tape.



**1 Do the procedure for singing along (steps 1 to 5 on page 24). Then, insert a recordable tape in deck B.**

**2 Press the function button of the source you want to record (e.g., CD).**

If you want to record from TAPE A, press TAPE A/B repeatedly until TAPE A is selected.

**3 Press REC PAUSE/START.**

Deck B standby for recording. The REC PAUSE/START button flashes.

**4 Press DIRECTION repeatedly to select  to record on one side. Select  (or RELAY) to record on both sides.**

**5 Press REC PAUSE/START.**

Recording starts.

continued

## Mixing and recording sounds (continued)

### 6 Press ◀▶ to start playing the source to be recorded.

Start singing along with the music.

#### After you have finished.

Turn MIC LEVEL to MIN and disconnect the microphone from MIC jack.

#### Tips

- You can mix and record sound from microphone after step 2. To record the sound see “Recording Manually” on page 19. To stop recording, press ■.
- If acoustic feedback (howling) occurs, move the microphone away from the speakers or change the direction of the microphone.
- If you want to record your voice through the microphone only, you can do so by selecting the CD function and not playing a CD.
- When high level sound signals are input, the unit automatically adjust the recording level to prevent distortion of the recorded sound signals (Auto Level/ Control Function).

#### Note

The microphone does not function during High Speed Dubbing.

## Falling asleep to music

### — Sleep Timer

You can set the system to turn off at a preset time, so you can fall asleep to the music.

#### Press SLEEP on the remote.

Each time you press the button, the minute display (the turn-off time) changes as follows:

AUTO\* → 90 → 80 → 70 → ... → 10 → OFF

\* The power turns off when the current CD or tape finishes playback (for up to 100 minutes).

To	Do this
Check the remaining time	Press SLEEP once.
Change the time to turn off	Press SLEEP repeatedly to select the time you want.
Cancel the Sleep Timer	Press SLEEP repeatedly until “SLEEP OFF” appears.

## Waking up to music

### — Daily Timer

You can wake up to music at a preset time every day. Make sure you have set the clock (see “Setting the clock” on page 8).

#### 1 Prepare the music source you want to play.

- CD: Load a CD. To start from a specific track, make a program (see “Programming the VIDEO CD/CD tracks” on page 12).
- Tape: Load a tape with the side you want to play facing forward.
- Radio: Tune in the preset station you want (see “Listening to the radio” on page 17).

#### 2 Adjust the volume.

#### 3 Press CLOCK/TIMER SET on the remote.

“DAILY1 SET” appears.

#### 4 Press ▼ or ▲ repeatedly to select “DAILY1 SET (or DAILY2 SET)”, then press ENTER.

“ON” appears and the hour digits flash in the display.

#### 5 Set the time to start playback.

Press ▼ or ▲ repeatedly to set the hour, then press ENTER.

The minute indication flashes.

Press ▼ or ▲ repeatedly to set the minute, then press ENTER.

The hour indication flashes again.

#### 6 Set the time to stop playback following step 5 above.

**7 Press ▼ or ▲ repeatedly until the music source you want appears.**

The indications change as follows:

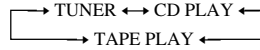

**8 Press ENTER.**

The type of timer (“DAILY1” or “DAILY2”), followed by the start time, stop time and the music source appears, then the original display appears.

**9 Turn off the power.**

To	Do this
Check the setting	Press CLOCK/TIMER SELECT on the remote and press ▼ or ▲ repeatedly to select the respective mode (“DAILY1” or “DAILY2”), then press ENTER.
Change the setting	Start from step 1.
Cancel the timer operation	Press CLOCK/TIMER SELECT on the remote and press ▼ or ▲ repeatedly to select “TIMER OFF”, then press ENTER.

**Tip**

The power turns on 15 seconds before the preset time.

**Note**

If you turn on the power before the preset time, Daily Timer will not function.

## Display

### Turning off the display

#### — Power Saving Mode

The demonstration display (the display changes and the indicators flash even when the system is turned off) and the clock display can be turned off to minimize the amount of power consumed during standby mode (Power Saving Mode).

**Press DISPLAY repeatedly while the system is turned off until the demonstration display or the clock display disappears.**

#### To cancel Power Saving Mode

**Press DISPLAY once to show the demonstration display, twice to show the clock display.**

Each time you press the button, the system changes cyclically as follows:

Demonstration → Clock\* → Power Saving Mode

\* “--:--” appears in the display if you have not set the clock.

#### Tips

- The  indicator lights up even in Power Saving Mode.
- The timer continues to operate in Power Saving Mode.
- During Power Saving Mode, the following functions do not work:
  - Setting the time.
  - Changing the AM tuning interval.
  - Pressing a function button to turn the power on.
  - Switching the function of MD (VIDEO).

### Using the display

You can check the remaining time of the current track or that of the VIDEO CD/CD.

When a CD TEXT disc is loaded, you can check the information stored on the disc, such as the titles. When the unit detects CD TEXT discs, the “CD TEXT” indicator appears in the display.

#### Checking the remaining time

**Press DISPLAY repeatedly during Normal Play.**

Each time you press the button, the display changes cyclically as follows:

#### CD/VIDEO CD without PBC function (Ver. 1.0)/Disc with MP3 files

Playing time of the current track → Remaining time of the current track or “--:--” display (while MP3 file is playing) → Remaining time of the current CD (“1 DISC” or “ALBUM” mode) or “--:--” display (except “1 DISC” or “ALBUM” mode or while MP3 file is playing) → Title name of the current track<sup>1)</sup> → Title name of the current folder<sup>2)</sup> → Clock display (for a few seconds) → Effect status

#### VIDEO CDs with PBC (Ver 2.0)

Playing time of the current track<sup>3)</sup> → clock display (for eight seconds) → Effect status

#### Checking the total playing time

**Press DISPLAY repeatedly in stop mode.**

Each time you press the button, the display changes cyclically as follows:

Total number of tracks or folder and the total playing time<sup>4)</sup> → Disc title<sup>1)</sup> or title name of the current folder<sup>2)</sup> → Clock display (for a few seconds) → Effect status

<sup>1)</sup> With CD TEXT discs only (certain characters cannot be displayed) or a disc with MP3 files. When the CD TEXT disc contains more than 20 tracks, title name of current track is not displayed from track 21 onwards.

<sup>2)</sup> Only for MP3 files.

<sup>3)</sup> May not appear with still images, etc.

<sup>4)</sup> Except for MP3 files.

#### Notes

- The display may not show all the characters depending on the disc.
- This player can only display the disc titles and tracks titles from CD TEXT discs. Other information cannot be displayed.

## Using the on screen display

You can check the current operating status and disc information of VIDEO CDs, audio CDs or MP3 during playback or when playback is stopped. Depending on conditions, some items are displayed and others are not.

### Press ON SCREEN on the remote.

Each time you press this button, the on-screen display changes as follow:

ON SCREEN 1 → ON SCREEN 2 →  
ON SCREEN OFF\*

\* No display (except for special menus)

### ON SCREEN 1, 2 display

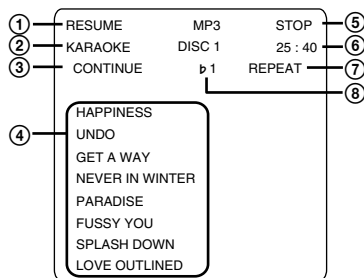

① VIDEO CD/CD/MP3 status	Displayed item
When playback is stopped	“RESUME” or no display
During playback	Current disc and track number

② KARAOKE effect status

③ Play mode or “AUTO PBC”\*

\* “AUTO PBC” appears for a VIDEO CD with PBC functions.

④ VIDEO CD/CD/MP3 status	Displayed item
When playback is stopped (Disc with MP3 files)	Folder name
During playback of a disc with MP3 files	Current folder name and file name
In program mode	Programmed disc and track numbers
Other conditions	No display

⑤ VIDEO CD/CD/MP3 status	Displayed item
When playback is stopped	“STOP”
During playback	Elapsed time of the current track

⑥ VIDEO CD/CD/MP3 status	Displayed item
When playback is stopped	Total playing time of current disc*
During playback	No display

\* In program mode, total playing time of the program appears (except for MP3 files).

⑦ “REPEAT”, “REPEAT 1” or no display

⑧ Key control level or no display

### Tip

During playback of VIDEO CD and ON SCREEN 1 is selected nothing appears on the on screen display. When any button for VIDEO CD operation is pressed, or when performing Time Search or Disc Digest function, the reaction is displayed on the on screen display.

### Note

Noise may be heard during changing of on screen display.

## Hooking Up the Optional Components

### Connecting an MD deck or VCR

You can connect your MD deck or VCR to this system. Be sure to match the color of the plugs and the connectors.

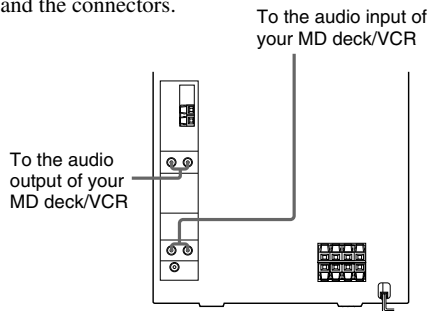

To	Do This
Make an analog recording from CD, TAPE or TUNER on to a Mini Disc	Connect the AUDIO OUT jacks to the audio input of the MD deck.
Record the audio and video signals from VIDEO CD on to a video tape	Connect the AUDIO OUT jacks to the audio input of VCR. Connect the VIDEO OUT jack to the video input of the VCR.
Listen to the analog sound of a connected MD deck	Press MD (VIDEO).
Listen to the connected VCR	Hold down MD (VIDEO) and press <b>I/⏻</b> while the power is on. Release <b>I/⏻</b> first, then release MD (VIDEO). This switches the function from MD to VIDEO. Once you switched to the VIDEO function, just press MD (VIDEO).

#### Notes

- Pressing the MD (VIDEO) while the power is off automatically turns the power on and MD is selected as a function.
- If the sound is distorted or too loud when VIDEO function is selected, or you want to switch back to MD function, repeat the operation described above to switch to MD function.

### Connecting a Video Game Player

You can enjoy the video games with audio emphasis by connecting a video game player.

To the audio and video output of your video game player.

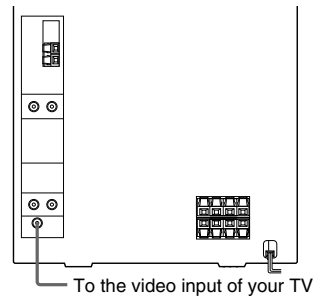
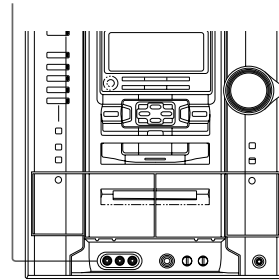

To	Do this
Listen to the sound of a connected video game player	Press GAME (or GAME on the remote).
Select the preset effect	(See "Selecting the preset effect" on page 22)

#### Note

Pressing GAME while the power is off automatically turns the power on and GAME is selected as a function. The equalizer also switches to GAME EQ and the previously selected effect is restored.

## Connecting external antennas

Connect an external antenna to improve the reception.

### FM antenna

Connect an optional FM external antenna. You can also use the TV antenna instead.

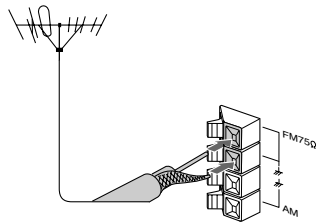

### AM antenna

Connect a 6 to 15 meter (20 to 50 feet) insulated wire to the AM antenna terminal. Leave the supplied AM loop antenna connected.

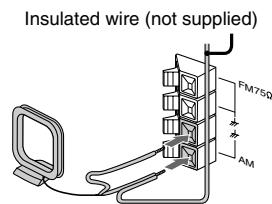

## Troubleshooting

### Problems and remedies

If you run into any problem using this unit, use the following check list.

First, check that the power cord is connected firmly and the speakers are connected correctly and firmly.

Should any problem persist, consult your nearest Sony dealer.

#### General

**The display starts flashing as soon as you plug in the power cord even though you haven't turned on the power.**

The demonstration mode started. Press  (see step 5 on page 7)

**The clock/timer setting is canceled.**

- The power cord is disconnected or a power failure occurs. Redo "Setting the clock" (on page 8). If you have set the timer, redo "Waking up to music" (on page 26) and "Timer-recording radio programs" (on page 20).

**The radio presetting is canceled.**

- The power cord is disconnected or a power failure occurs for longer than half a day. Redo "Presetting radio stations" (on page 17).

**There is no sound.**

- Turn VOLUME clockwise.
- The headphones are connected to the PHONES jack.
- Insert only the stripped portion of the speaker cord into the SPEAKER jack. Inserting the vinyl portion of the speaker cord will obstruct the speaker connections.
- The protective device on the amplifier has been activated because of short circuit. ("PROTECT" and "PUSH POWER" flash alternately.) Turn off the unit. Make sure the stripped ends of each speaker cord does not touch another speaker terminal or the stripped end of another speaker cord. Then turn on the power again.
- There is no audio output during Timer-Recording.

**There is severe hum or noise.**

- A TV or VCR is placed too close to the unit. Move the unit away from the TV or VCR.

**The sound from the component connected to the MD (VIDEO) jacks is distorted.**

- If "VIDEO" appears in the display when you press MD (VIDEO), switch to "MD" function (see "Note: Connecting an MD deck/VCR" on page 30).

**"-- --:-- --" appears in the display.**

- A power interruption occurred. Set the clock and timer settings again.

**The timer does not function.**

- Set the clock correctly.
- You cannot activate the Daily timer and Timer-recording simultaneously.

**"DAILY1 SET", "DAILY2 SET", and "REC SET" do not appear when you press the CLOCK/TIMER SET button.**

- Set the timer correctly.
- Set the clock.

**The remote does not function.**

- There is an obstacle between the remote and the system.
- The remote is not pointing in the direction of the unit's sensor.
- The batteries have run down. Replace the batteries.

**There is acoustic feedback.**

- Decrease the volume level.
- Move the microphone away from the speakers or change the direction of the microphone.

**The color irregularity on a TV screen persists.**

- Turn off the TV set once, then turn it on after 15 to 30 minutes. If the color irregularity still persists, place the speakers farther away from the TV set.

**"PROTECT" and "PUSH POWER" appear alternately.**

- A strong signal is input. Turn off the power, leave the system turned off for a while, then turn on the power again. If "PROTECT" and "PUSH POWER" still appear alternately check the speaker cords.

#### Speakers

**Sound comes from only one channel or unbalanced left and right volume.**

- Check the speaker connection and speaker placement.

**Sound lacks bass.**

- Check that the speaker's + and - terminals are connected correctly.



## VIDEO CD/CD/MP3 Player

### The disc tray does not open and “LOCKED” appears on the front panel display.

- Contact your Sony dealer or local authorized Sony service facility.

### There is no picture.

- Check the player is connected securely.
- Make sure you operate the TV correctly.
- Make sure you set the colour system correctly, according to your TV (color) system.
- Press CD.
- Press GAME MIXING until “MIXING □□□” disappears.

### The disc tray does not close.

- The CD is not placed properly.

### The CD does not play.

- The CD is not lying flat in the disc tray.
- The CD is dirty.
- The CD is inserted label side down.
- Moisture condensation has built up. Remove the CD and leave the system turned on for about an hour until the moisture evaporates.

### Playback does not start from the first track.

- The player is in Program Play or Shuffle Play mode. Press PLAY MODE repeatedly until “1 DISC”, “ALBUM” or “ALL DISCS” appears.

### MP3 files cannot be played back.

- Recording was not performed according to the ISO 9660 level 1 or level 2 format.
- The file extension “MP3” is not added to the file names.
- The files are not stored in MP3 format.
- The discs containing files other than MPEG 1 Audio Layer-3 files cannot be played.
- The files that are 64 kB or smaller cannot be played.

### MP3 files takes longer time to playback than others.

- After the unit reads all files on the disc, playback may take more time than usual if
  - the number of folders or files on the disc is very large.
  - the folder and file organization structure is very complex.

### The folder title, track title, and ID3 tag do not appear correctly.

- The CD was not recorded in conformance ISO 9660 level 1 or level 2. Use CD that conforms with ISO 9660 level 1 or level 2.

### The folder title, track title, ID3 tag and the CD TEXT characters don't appear properly.

- The character code that can be displayed by this unit are as follows.
    - Upper cases (A to Z)
    - Numbers (0 to 9)
    - Symbols (<> \* +, - / [ ] \ \_)
- Other characters may not be displayed correctly.

### About ID3 tag version 2

Although not a malfunction, the following occurs when an MP3 file containing ID3 tag ver. 2 is played:

- When skipping a portion of ID3 tag ver. 2 (at the beginning of the track), sound is not output. Skip time changes depending on ID3 tag ver. 2 capacity.  
Example: At 64 kbytes, it is about 2 seconds (with RealJukebox\*).
- The displayed elapsed playing time when skipping a portion of ID3 tag ver. 2 is inaccurate. For MP3 files of a bit rate other than 128 kbps, time is not displayed accurately during playback.
- When an MP3 file is created with MP3 conversion software (ex. RealJukebox\*), ID3 tag ver. 2 will automatically be written.

\* “RealJukebox” is a registered trademark of RealNetworks, Inc.

As of December, 2001

continued

Troubleshooting

## Problems and remedies (continued)

### Tape Deck

---

**The tape does not record.**

- The tab has been removed from the cassette, cover the broken tab with adhesive tape.
- The tape has reeled to the end.

---

**The tape does not record nor play or there is a decrease in sound level.**

- The heads are dirty. (See “Cleaning the tape heads” on page 35).
- The record/playback heads are magnetized. (See “Demagnetizing the tape heads” on page 35).

---

**The tape does not erase completely.**

- The record/playback heads are magnetized. (See “Demagnetizing the tape heads” on page 35).

---

**There is excessive wow or flutter, or the sound drops out.**

- The capstans or pinch rollers are dirty. (See “Cleaning the tape heads” on page 35).

---

**Noise increases or the high frequencies are erased.**

- The record/playback heads are magnetized. (See “Demagnetizing the tape heads” on page 35).

---

### Tuner

---

**There is severe hum or noise (“TUNED” or “STEREO” flashes in the display).**

- Adjust the antenna.
- The signal is too weak. Connect an external antenna.

---

**A stereo FM program cannot be received in stereo.**

- Press FM MODE so that “MONO” disappears.

---

**If other troubles not described above occur, reset the system as follows:**

- 1 Press ■, ENTER and I/⏻ at the same time.
- 2 Unplug the power cord.
- 3 Plug the power cord back in.
- 4 Press I/⏻ to turn on the power.

The unit is reset to factory settings. All the settings are cleared.

## Messages

---

### VIDEO CD/CD

---

**CANNOT USE**

You press an incorrect button.

---

**CANNOT EDIT**

- You press ◀/▶/▲/▼ during Karaoke mode.
- You press CINEMA SPACE during Karaoke mode.
- You press EDIT before CD is ready.

---

**CD NO STEP**

You have cleared all the tracks you programmed.

---

**OVER**

You have reached the end of the CD or MP3 files. Press ◀◀.

---

**PUSH STOP**

You press PLAY MODE during play.

---

**STEP FULL**

You tried to program 26 or more tracks (steps).

---

**TOC READING**

The system is reading the TOC information of the disc. Some buttons are not available.

---

## Additional Information

### Precautions

#### On operating voltage

Before operating the unit, check that the operating voltage of your unit is identical with the voltage of your local power supply.

#### On safety

- The unit is not disconnected from the AC power source (mains) as long as it is connected to the wall outlet, even if the unit itself has been turned off.
- Unplug the unit from the wall outlet (mains) if it is not to be used for an extended period of time. To disconnect the cord (mains lead), pull it out by the plug. Never pull the cord itself.
- Should any solid object or liquid fall into the component, unplug the unit and have the component checked by qualified personnel before operating it any further.
- The AC power cord must be changed only at the qualified service shop.

#### On placement

- Do not place the unit in an inclined position.
- Do not place the unit in locations where it is:
  - extremely hot or cold
  - dusty or dirty
  - very humid
  - vibrating
  - subject to direct sunlight
- Use caution when placing the unit or speakers on surfaces that have been specially treated (with wax, oil, polish, etc.) as staining or discoloration of the surface may result.

#### On heat build up

- Although the unit heats up during operation, this is not a malfunction.
- Place the unit in a location with adequate ventilation to prevent heat build up in the unit.

If you use this unit at a large volume, the cabinet temperature of the top, side and bottom rises considerably. To avoid burning yourself, do not touch the cabinet.

To prevent a malfunction, do not cover the ventilation hole for the cooling fan.

#### On operation

- If the unit is brought directly from a cold to a warm location, or is placed in a very damp room, moisture may condense on the lens inside the CD player. Should this occur, the unit will not operate properly. Remove the CD and leave the unit turned on for about an hour until the moisture evaporates.
  - When you move the unit, take out any discs.
- If you have any questions or problems concerning your unit, please consult your nearest Sony dealer.

#### Notes on CDs

- Before playing, clean the CD with a cleaning cloth. Wipe the CD from the center out.
- Do not use solvents.
- Do not expose the CD to direct sunlight or heat sources.
- Discs with non-standard shapes (e.g., heart, square, star) cannot be played on this unit. Attempting to do so may damage the unit. Do not use such discs.

#### Note on CD-R/CD-RW playback

Discs recorded on CD-R/CD-RW drives may not be played back because of scratches, dirt, recording conditions or the drive's characteristics. Besides, the discs which are not yet finalized at the end of recording, cannot be played back.

#### Cleaning the cabinet

Use a soft cloth slightly moistened with mild detergent solution.

#### To save a tape permanently

To prevent a tape from being accidentally recorded over, break off the cassette tab. Refer to the instructions of the tape.

#### Before placing a cassette in the tape deck

Take up any slack in the tape. Otherwise the tape may get entangled in the parts of the tape deck and become damaged.

#### When using a tape longer than 90 minutes

The tape is very elastic. Do not change the tape operations such as play, stop, and fast-winding etc. frequently. The tape may get entangled in the tape deck.

#### Cleaning the tape heads

Clean the tape heads after every 10 hours of use. Make sure to clean the tape heads before you start an important recording or after playing an old tape. Use separately sold dry-type or wet-type cleaning cassette. For details, refer to the instructions of the cleaning cassette.

#### Demagnetizing the tape heads

Demagnetize the tape heads and the metal parts that have contact with the tape every 20 to 30 hours of use with a separately sold demagnetizing cassette. For details, refer to the instructions of the demagnetizing cassette.

#### In case color irregularity is observed in nearby a TV screen

With the magnetically shielded type of speaker system, the speakers can be installed near a TV set. However, color irregularity may still be observed in the TV screen depending on the type of your TV set.

#### If color irregularity is observed...

Turn off the TV set once, then turn it on after 15 to 30 minutes.

#### If color irregularity is observed again...

Place the speakers farther away from the TV set.

## Specifications

### Amplifier section

The following are measured at AC 220V 50/60 Hz

DIN power output (rated)	160 + 160 watts (6 ohms at 1 kHz, DIN)
Continuous RMS power output (reference)	200 + 200 watts (6 ohms at 1 kHz, 10% THD)
Inputs	
GAME (VIDEO): (phono jack)	1 Vp-p, 75 ohms
GAME (AUDIO): (phono jacks)	Voltage 250 mV, impedance 47 kilohms
MD/VIDEO (AUDIO) IN: (phono jacks)	voltage 450 mV/250 mV, impedance 47 kilohms
MIC: (phone jack)	sensitivity 1 mV, impedance 10 kilohms
Outputs	
VIDEO OUT: (phono jacks)	max. output level 1 Vp-p, unbalanced, Sync. negative load impedance 75 ohms
AUDIO OUT: (phono jacks)	Voltage 250 mV impedance 47 kilohms
PHONES: (stereo mini jack)	accepts headphones of 8 ohms or more
FRONT SPEAKER:	accepts impedance of 6 to 16 ohms
SURROUND SPEAKER:	accepts impedance of 24 ohms or more

### VIDEO CD/CD player section

System	Compact disc and digital audio system
Laser	Semiconductor laser ( $\lambda=795\text{nm}$ )
Frequency response	2 Hz – 20 kHz ( $\pm 0.5$ dB)
Wave length	795 nm
Video color system format	NTSC, PAL

### Tape player section

Recording system	4-track 2-channel stereo
Frequency response	50 – 13,000 Hz ( $\pm 3$ dB), using Sony TYPE I cassette
Wow and flutter	$\pm 0.15\%$ W.Peak (IEC) 0.1% W.RMS (NAB) $\pm 0.2\%$ W.Peak (DIN)

### Tuner section

FM stereo, FM/AM superheterodyne tuner

#### FM tuner section

Tuning range	87.5 – 108.0 MHz
Antenna	FM lead antenna
Antenna terminals	75 ohm unbalanced
Intermediate frequency	10.7 MHz

#### AM tuner section

Tuning range	531 – 1,602 kHz (with the interval set at 9 kHz) 530 – 1,710 kHz (with the interval set at 10 kHz)
Antenna	AM loop antenna
Antenna terminals	External antenna terminal
Intermediate frequency	450 kHz

## Speaker

### Front speaker SS-RV8

Speaker system	3-way, 3-unit, bass-reflex type magnetically shielded
Speaker units	
Super Woofer:	15 cm, cone type
Woofer:	15 cm, cone type
Tweeter:	5 cm, cone type
Nominal impedance	6 ohms
Dimensions (w/h/d)	Approx. 250 x 395 x 310 mm
Mass	Approx. 6.6 kg net per speaker

### Surround speaker SS-RSV8

Speaker system	2 way, 2 unit, bass-reflex type magnetically shielded
Speaker units	
Woofer	13 cm, cone type
Tweeter	5 cm, cone type
Nominal impedance	24 ohms
Dimensions (w/h/d)	Approx. 175 x 360 x 190 mm
Mass	Approx. 3.6 kg net per speaker

## General

Power requirements	220 V AC, 50/60 Hz
Power consumption	240 watts
Dimensions (w/h/d)	
HCD-RV7	Approx. 280 x 360 x 445 mm
Mass :	
HCD-RV7	Approx. 11.0 kg
Supplied accessories:	AM loop antenna (1) Remote commander (1) Batteries (2) FM lead antenna (1) Video cable (1) Front speaker pads (8) Surround speaker pads (8)

Design and specifications are subject to change without notice.

## Glossary

### Auto Pause

An automatically pauses according to the signal encoded on the disc while playing a VIDEO CD. If the CD player does not resume play for a long time, press ◀▶ to resume play manually.

### Menu Playback

Playback using the menu screens recorded on VIDEO CDs with PBC functions. You can enjoy simple interactive software using the menu playback function.

### Playback Control (PBC)

Signals encoded on VIDEO CDs (Version 2.0) to control playback.

By using menu screens recorded on VIDEO CDs with PBC functions, you can enjoy playing simple interactive software, software with search functions, and so on.

When you select a VIDEO CD with PBC functions on this player, the PBC indicator lights up.

### Track

Sections of a picture or a music piece on disc. Each track is assigned a track number to help you locate the track you want.

### VIDEO CD

A compact disc which contains moving pictures.

VIDEO CDs contain compact picture information using the MPEG 1 format, one of the world wide standards of digital compact technology. The picture information is compressed about 120 times. Consequently, a 12 cm VIDEO CD can contain up to 74 minutes of moving pictures.

VIDEO CDs also contain compact audio information. Sounds outside the range of human hearing are compressed while the sounds we can hear are not compressed. VIDEO CDs can hold six times the audio information of conventional audio CDs.

There are two versions for VIDEO CDs:

Version 1.1 (VIDEO CDs without PBC functions):

You can play only moving pictures and sounds.

Version 2.0 (VIDEO CDs with PBC functions):

You can play still pictures and enjoy PBC functions.

This player can play both versions.



