

FM Stereo FM-AM Receiver

Operating Instructions



STR-DE875

WARNING

To prevent fire or shock hazard, do not expose the unit to rain or moisture.

To avoid electrical shock, do not open the cabinet. Refer servicing to qualified personnel only.

Do not install the appliance in a confined space, such as a bookcase or built-in cabinet.



Don't throw a battery, dispose it as the injurious wastes.

Precautions

On safety

- Should any solid object or liquid fall into the cabinet, unplug the receiver and have it checked by qualified personnel before operating it any further.
- To prevent fire, do not cover the ventilation of the receiver with newspapers, table cloths, curtains, etc. And don't place lighted candles on the receiver.
- To prevent fire or shock hazards, do not place vases on the receiver.

On power sources

- Before operating the receiver, check that the operating voltage is identical with your local power supply. The operating voltage is indicated on the nameplate at the rear of the receiver.
- The unit is not disconnected from the AC power source (mains) as long as it is connected to the wall outlet, even if the unit itself has been turned off.
- If you are not going to use the receiver for a long time, be sure to disconnect the receiver from the wall outlet. To disconnect the AC power cord, grasp the plug itself; never pull the cord.
- AC power cord must be changed only at the qualified service shop.

On placement

- Place the receiver in a location with adequate ventilation to prevent heat buildup and prolong the life of the receiver.
- Do not place the receiver near heat sources, or in a place subject to direct sunlight, excessive dust or mechanical shock.
- Do not place anything on top of the cabinet that might block the ventilation holes and cause malfunctions.
- Although the receiver heats up during operation, this is not a malfunction. If you continuously use this receiver at a large volume, the cabinet temperature of the top, side and bottom rises accordingly. To avoid burning yourself, do not touch the cabinet.

On operation

Before connecting other components, be sure to turn off and unplug the receiver.

On cleaning

Clean the cabinet, panel and controls with a soft cloth slightly moistened with a mild detergent solution. Do not use any type of abrasive pad, scouring powder or solvent such as alcohol or benzene.

If you have any question or problem concerning your receiver, please consult your nearest Sony dealer.

About This Manual

The instructions in this manual is for model STR-DE875. Check your model number by looking at the lower right corner of the front panel.

Conventions

- The instructions in this manual describe the controls on the receiver. You can also use the controls on the supplied remote if they have the same or similar names as those on the receiver.
- The following icon is used in this manual:
 Indicates hints and tips for making the task easier.

This receiver incorporates Dolby* Digital and Pro Logic Surround and the DTS** Digital Surround System.

* *Manufactured under license from Dolby Laboratories. "Dolby", "Pro Logic" and the double-D symbol  are trademarks of Dolby Laboratories. Confidential unpublished Works. © 1992-1997 Dolby Laboratories. All rights reserved.*

***Manufactured under license from Digital Theater Systems, Inc. US Pat. No. 5,451,942, 5,956,674, 5,974,380, 5,978,762 and other world-wide patents issued and pending. "DTS", "ES" and "DTS Digital Surround" are registered trademarks of Digital Theater Systems, Inc. Copyright 1996, 2000 Digital Theater Systems, Inc. All Rights Reserved.*

TABLE OF CONTENTS

Hooking Up the Components 4

- Unpacking 4
- Antenna Hookups 5
- Audio Component Hookups 6
- Video Component Hookups 7
- Digital Component Hookups 8
- MULTI CH IN Hookups 10
- Other Hookups 11

Hooking Up and Setting Up the Speaker System 13

- Speaker System Hookup 14
- Performing Initial Setup Operations 16
- Multi Channel Surround Setup 17
- Before You Use Your Receiver 22

Location of Parts and Basic Operations 23

- Front Panel Parts Description 23

Enjoying Surround Sound 28

- Selecting a Sound Field 29
- Understanding the Multi-Channel Surround Displays 32
- Customizing Sound Fields 34

Receiving Broadcasts 42

- Storing FM Stations Automatically in Alphabetical Order ("Auto-betical") 44
- Direct Tuning 44
- Automatic Tuning 45
- Preset Tuning 45
- Using the Radio Data System (RDS) 46

Other Operations 48

- Naming Preset Stations and Program Sources 49
- Recording 49
- Using the Sleep Timer 50
- Adjustments Using the SET UP Button 51
- CONTROL A1II Control System 52

Additional Information 54

- Troubleshooting 54
- Specifications 56
- Glossary 58
- Tables of Settings Using SURR, LEVEL, EQ, and SET UP buttons 59
- Remote Button Description 61
- Index Back cover

Hooking Up the Components

This chapter describes how to connect various audio and video components to the receiver. Be sure to read the sections for the components you have before you actually connect them to the receiver.

Unpacking

Check that you received the following items with the receiver:

- FM wire antenna (1)
- AM loop antenna (1)
- Remote commander (remote) (1)
- R6 (size-AA) batteries (2)

Inserting batteries into the remote

Insert batteries with the + and – properly oriented in the battery compartment. When using the remote, point it at the remote sensor  on the receiver.

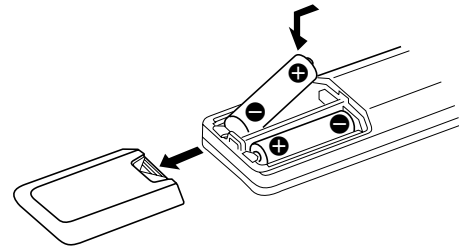

When to replace batteries

Under normal conditions, the batteries should last for about 6 months. When the remote no longer operates the receiver, replace all batteries with new ones.

Notes

- Do not leave the remote in an extremely hot or humid place.
- Do not use a new battery with an old one.
- Do not expose the remote sensor to direct sunlight or lighting apparatuses. Doing so may cause a malfunction.
- If you don't use the remote for an extended period of time, remove the batteries to avoid possible damage from battery leakage and corrosion.

Before you get started

- Turn off the power to all components before making any connections.
- Do not connect the AC power cord until all of the connections are completed.
- Be sure to make connections firmly to avoid hum and noise.
- When connecting an audio/video cord, be sure to match the color-coded pins to the appropriate jacks on the components: yellow (video) to yellow; white (left, audio) to white; and red (right, audio) to red.

Antenna Hookups

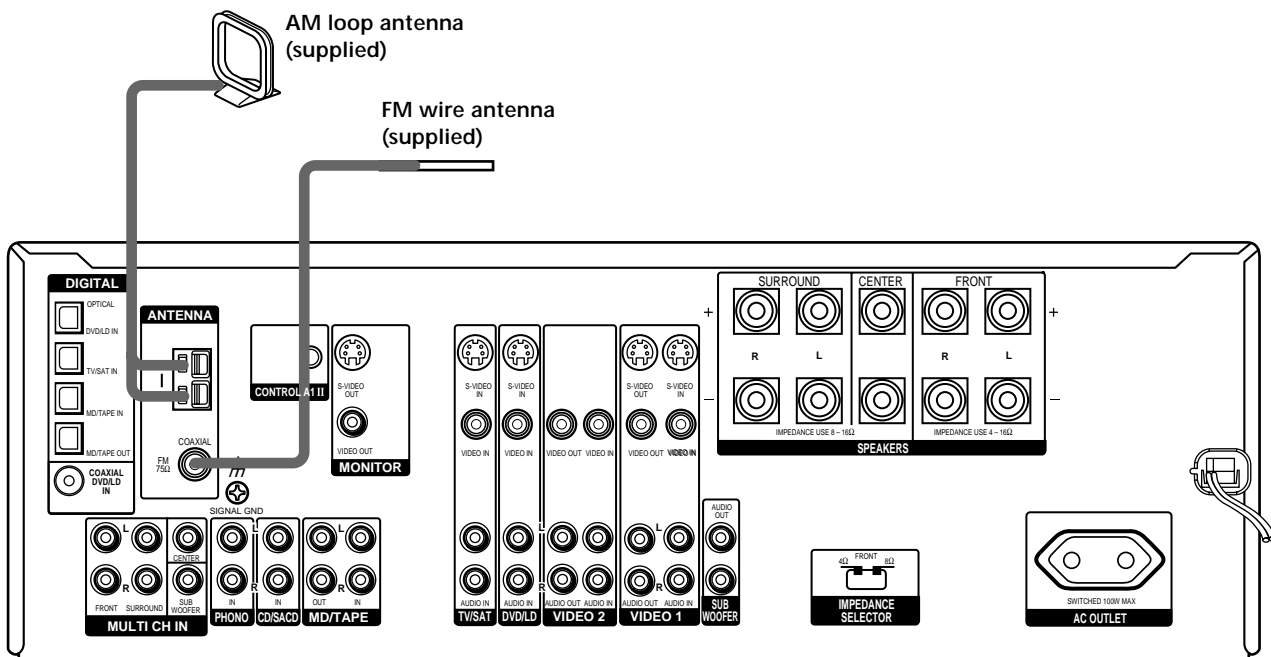

Terminals for connecting the antennas

Connect the	To the
AM loop antenna	AM terminals
FM wire antenna	FM 75Ω COAXIAL terminal

Notes on antenna hookups

- To prevent noise pickup, keep the AM loop antenna away from the receiver and other components.
- Be sure to fully extend the FM wire antenna.
- After connecting the FM wire antenna, keep it as horizontal as possible.

If you have poor FM reception

Use a 75-ohm coaxial cable (not supplied) to connect the receiver to an outdoor FM antenna as shown below.

Outdoor FM antenna

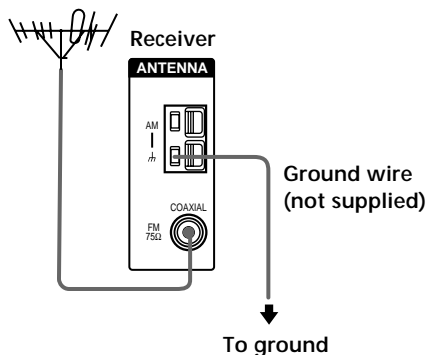

Important

If you connect the receiver to an outdoor antenna, ground it against lightning. To prevent a gas explosion, do not connect the ground wire to a gas pipe.

Note

Do not use the h SIGNAL GND terminal for grounding the receiver.

Audio Component Hookups

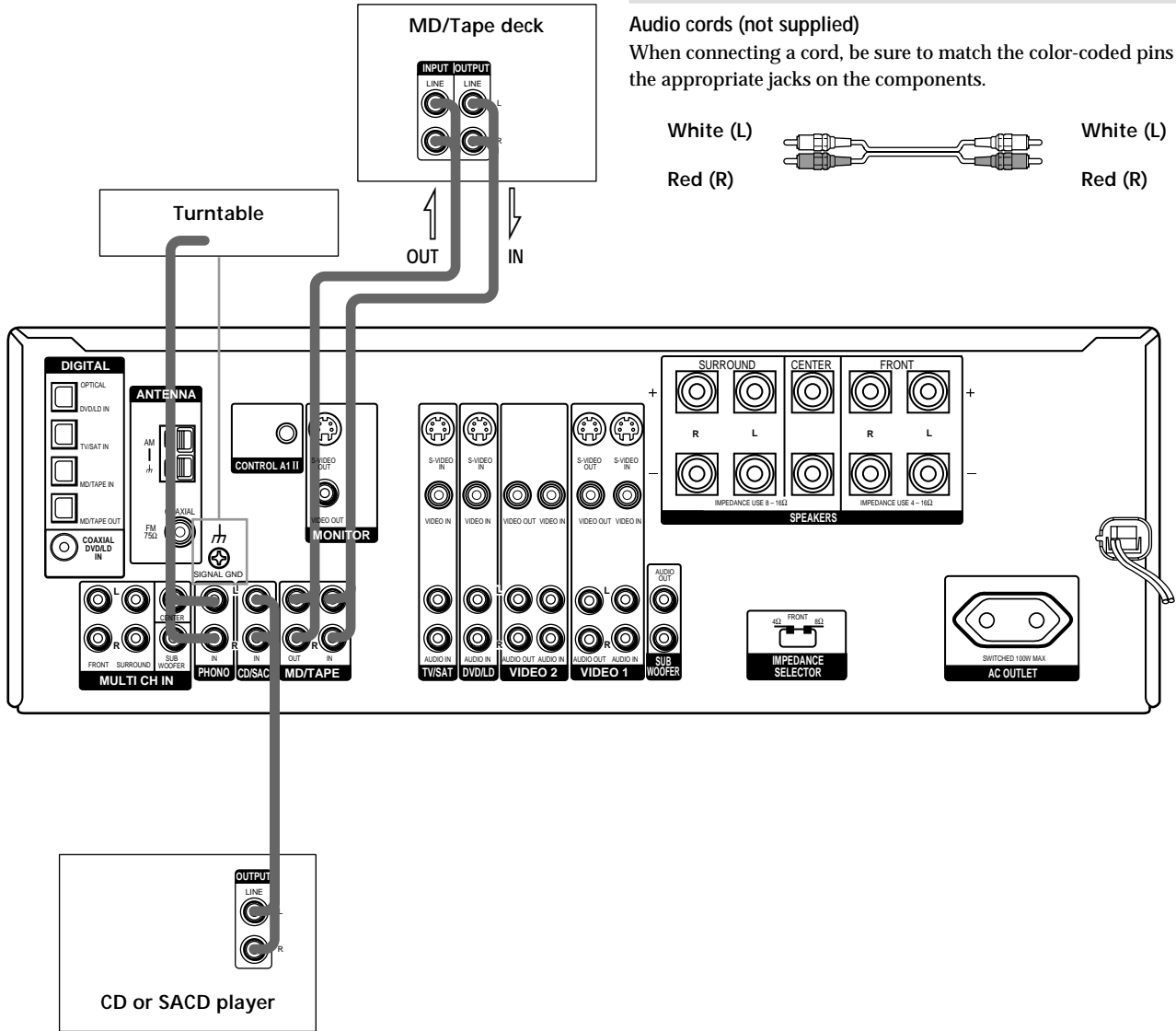

Required cords

Audio cords (not supplied)
When connecting a cord, be sure to match the color-coded pins to the appropriate jacks on the components.



Jacks for connecting audio components

Connect a	To the
Turntable	PHONO jacks
CD or SACD player	CD/SACD jacks
MD deck or tape deck	MD/TAPE jacks

Note on audio component hookups

If your turntable has a ground wire, connect it to the *h* SIGNAL GND terminal on the receiver.

Video Component Hookups

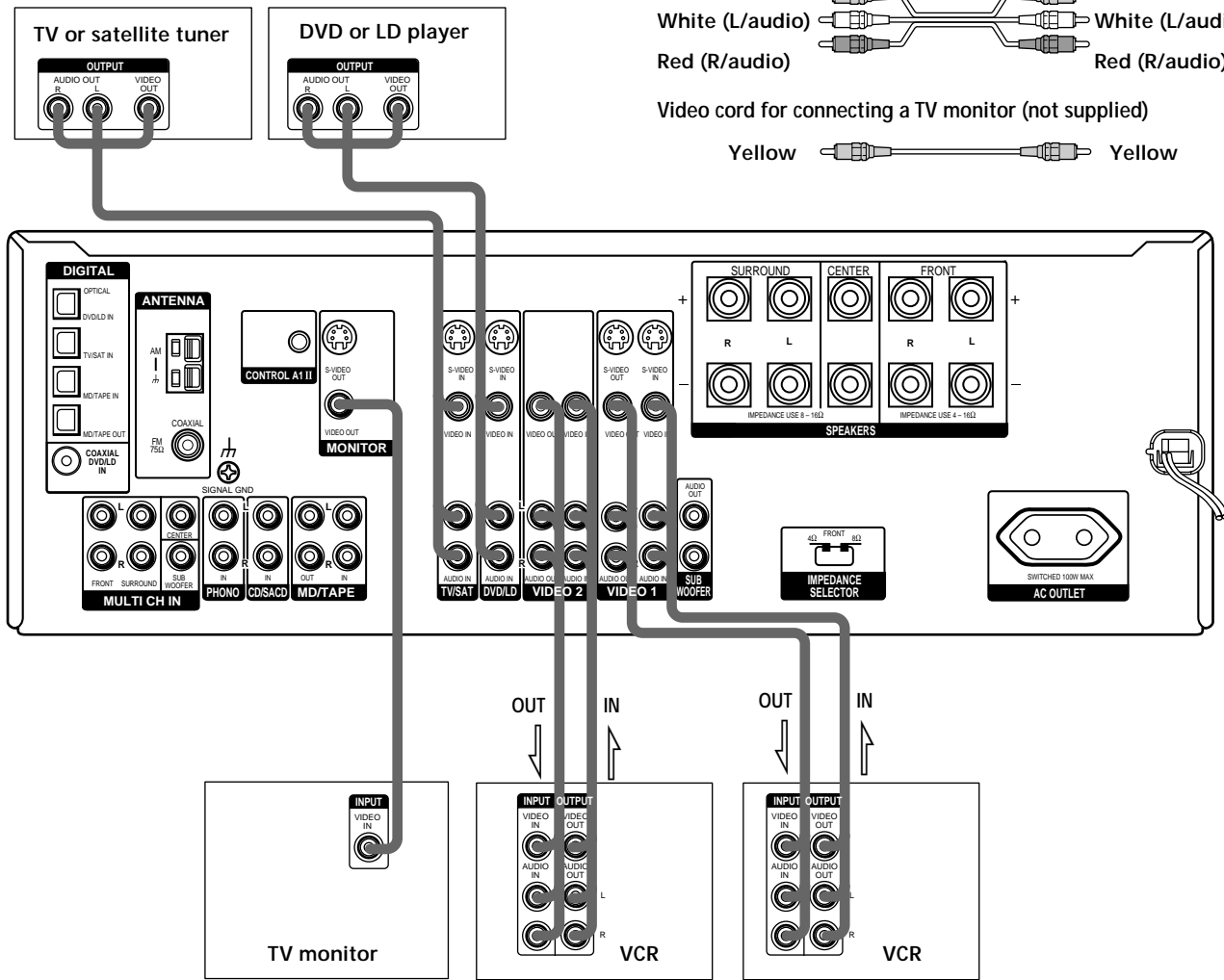

Required cords

Audio/video cords (not supplied)

When connecting a cord, be sure to match the color-coded pins to the appropriate jacks on the components.

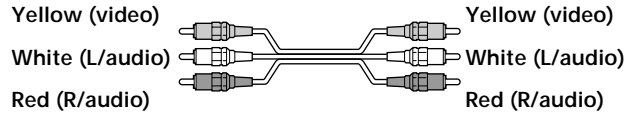

Video cord for connecting a TV monitor (not supplied)



Jacks for connecting video components

Connect a	To the
TV or satellite tuner	TV/SAT jacks
VCR	VIDEO 1 jacks
Additional VCR	VIDEO 2 jacks
DVD or LD player	DVD/LD jacks
TV monitor	MONITOR VIDEO OUT jack

Note on video component hookups

You can connect your TV's audio output jacks to the TV/SAT AUDIO IN jacks on the receiver and apply sound effects to the audio from the TV. In this case, do not connect the TV's video output jack to the TV/SAT VIDEO IN jack on the receiver. If you are connecting a separate TV tuner (or satellite tuner), connect both the audio and video output jacks to the receiver as shown above.

When using the S-video jacks instead of the video jacks Your monitor must also be connected via an S-video jack. S-video signals are on a separate bus from the video signals and will not be output through the video jacks.

Digital Component Hookups

Connect the digital output jacks of your DVD player and satellite tuner (etc.) to the receiver's digital input jacks to bring the multi channel surround sound of a movie theater into your home. To enjoy full effect of multi channel surround sound, five speakers (two front speakers, two surround speakers, and a center speaker) and a sub woofer are required. You can also connect an LD player with an RF OUT jack via an RF demodulator, like the Sony MOD-RF1 (not supplied).

Required cords

Optical digital cords (not supplied)

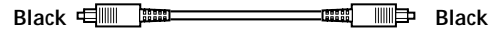

Coaxial digital cord (not supplied)

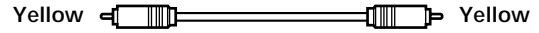

Audio/video cords (not supplied)

When connecting a cord, be sure to match the color-coded pins to the appropriate jacks on the components.

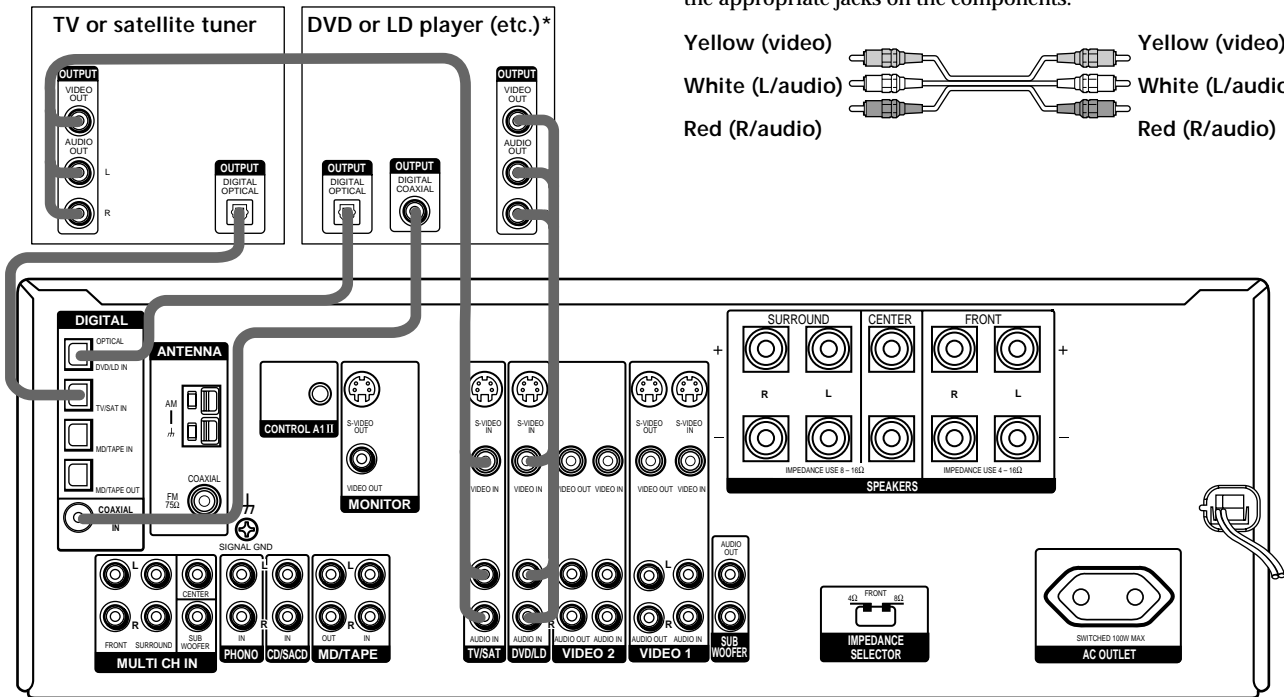
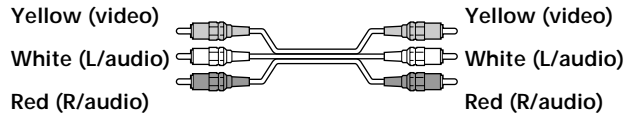

* When making digital audio connections to a DVD player, connect to either the coaxial OR optical digital jacks, and not both. It is recommended to make digital audio connections to the coaxial jack.

Example of LD player connected via an RF demodulator

Please note that you cannot connect an LD player's DOLBY DIGITAL RF OUT jack directly to this unit's digital input jacks. You must first convert the RF signal to either an optical or coaxial digital signal. Connect the LD player to the RF demodulator, then connect the RF demodulator's optical or coaxial digital output to this unit's OPTICAL or COAXIAL DVD/LD IN jack. Refer to the instruction manual supplied with your RF Demodulator for details on DOLBY DIGITAL RF hookups.

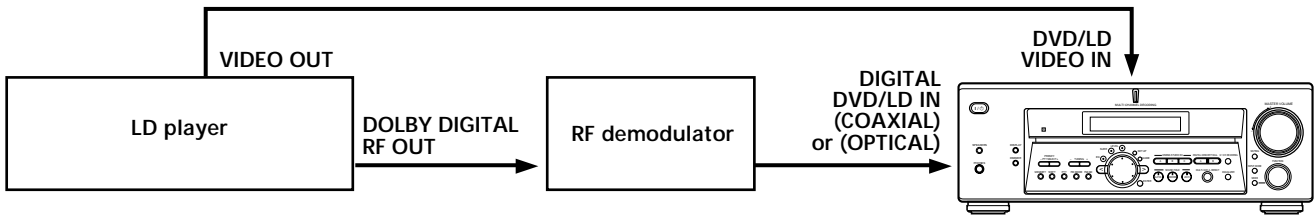

Note

When making connections as shown above, be sure to set INPUT MODE (10 on page 25) manually. This receiver may not operate correctly if INPUT MODE is set to "AUTO 2CH" or "AUTO MULTI CH".

Connect the digital output jacks of your MD or tape deck to the receiver's digital input jack and connect the digital input jacks of your MD or tape deck to the receiver's digital output jack. These connections allow you to make digital recordings of a CDs played back through your DVD (or LD player) and satellite broadcasts.

Required cords

Optical digital cords (not supplied)

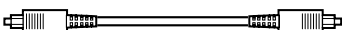
Black  Black

Audio cords (not supplied)

When connecting a cord, be sure to match the color-coded pins to the appropriate jacks on the components.

White (L)  White (L)
 Red (R)  Red (R)

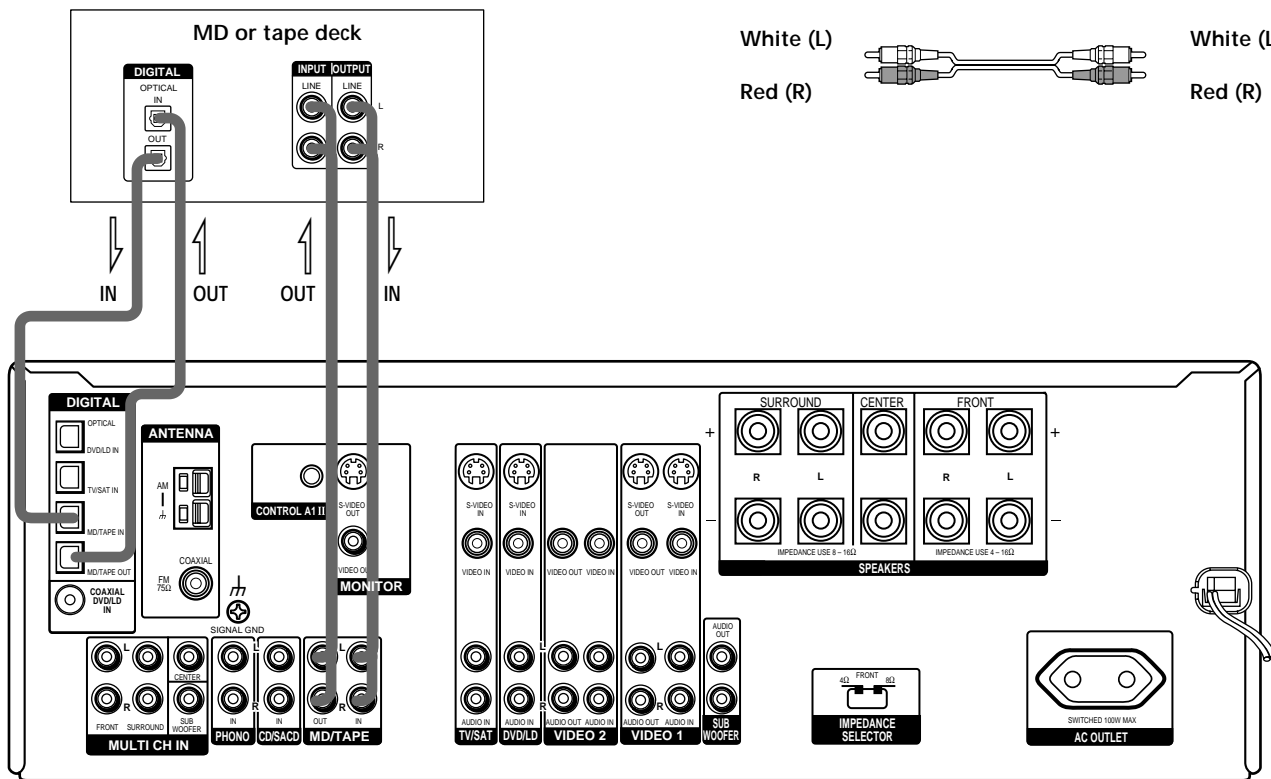

Notes

- Please note that you cannot make a digital recording of a digital multi channel surround signal.
- To make a digital recording from your CD or SACD player, connect the CD or SACD player's digital output directly to the digital input on your MD or tape deck. Refer to the instructions supplied with your CD or SACD player and MD or tape deck for details.
- The DVD/LD IN OPTICAL and COAXIAL jacks are compatible with 96 kHz, 48 kHz, 44.1 kHz and 32 kHz sampling frequencies. The other OPTICAL jacks are compatible with 48 kHz, 44.1 kHz and 32 kHz sampling frequencies.
- It is not possible to record analog signals to MD/TAPE and VIDEO with only digital connections. To record analog signals, make analog connections. To record digital signals, make digital connections.
- Input signals with 96 kHz sampling frequencies to the DVD/LD IN OPTICAL or COAXIAL jacks. Using other jacks may result in intermittent sound.

MULTI CH IN Hookups

Although this receiver incorporates a multi channel decoder, it is also equipped with MULTI CH IN jacks. These connections allow you to enjoy multichannel software encoded in formats other than Dolby Digital and DTS. If your DVD player is equipped with MULTI CH OUTPUT jacks, you can connect them directly to this unit to enjoy the sound of the DVD player's multi channel decoder. Alternatively, the MULTI CH IN jacks can be used to connect an external multi channel decoder. To fully enjoy multi channel surround sound, you will need five speakers (two front speakers, two surround speakers, and a center speaker) and a sub woofer. Refer to the instruction manual supplied with your DVD player, multi channel decoder, etc., for details on the multi channel input hookups.

Required cords

Audio cords (not supplied)

Two for the MULTI CH IN FRONT and SURROUND jacks

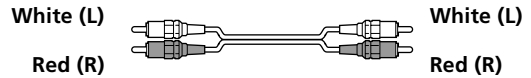

Monaural audio cords (not supplied)

Two for the MULTI CH IN CENTER and SUB WOOFER jacks



Video cord (not supplied)

One for the DVD/LD VIDEO IN jacks (etc.)



Notes

- When using the connections described below, adjust the level of your surround speakers and sub woofer from the DVD player or multichannel decoder.
- When you set the center speaker to use as the surround back speaker in the speaker settings, the signal input at the MULTI CH IN CENTER jack is directly output from the surround back speaker. For details about the speaker settings, refer to "Multi Channel Surround Setup" on pages 17 – 21.

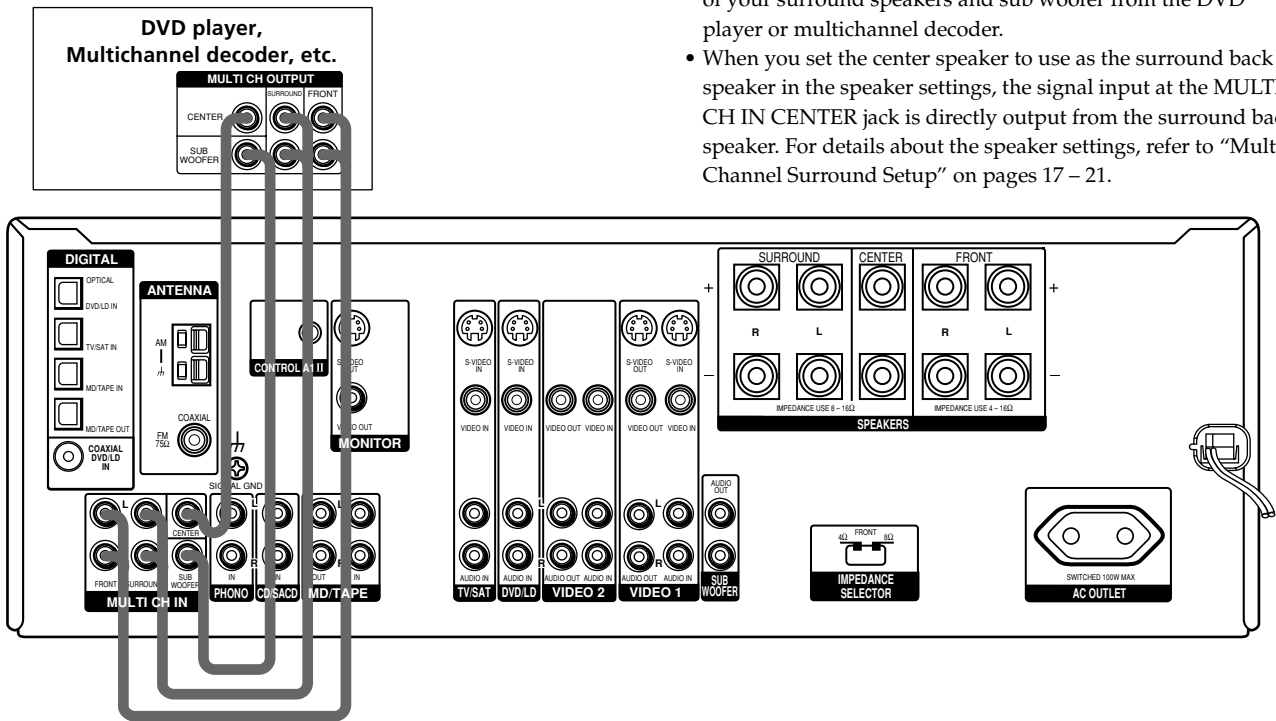

Example of a DVD player hookup using the MULTI CH IN jacks

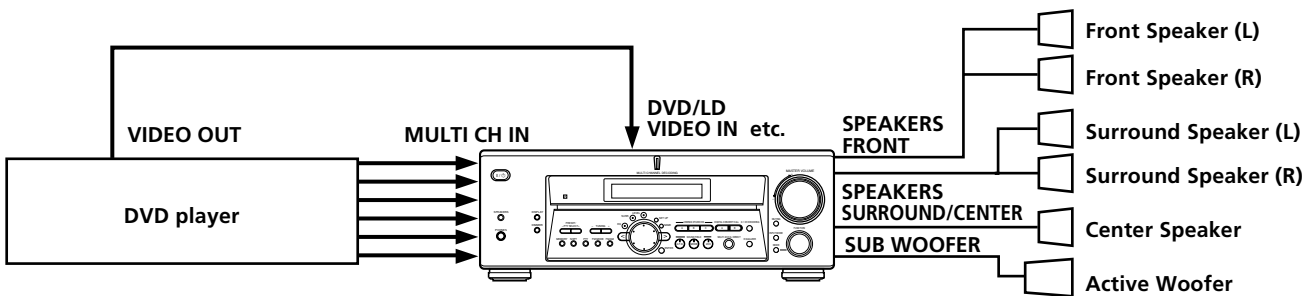

Note

See page 14 for details on speaker system hookup.

Other Hookups

Required cords

Audio cords (not supplied)

When connecting a cord, be sure to match the color-coded pins to the appropriate jacks on the components.

White (L)  White (L)
 Red (R)  Red (R)

CONTROL A1 connecting cord (not supplied)

Black  Black

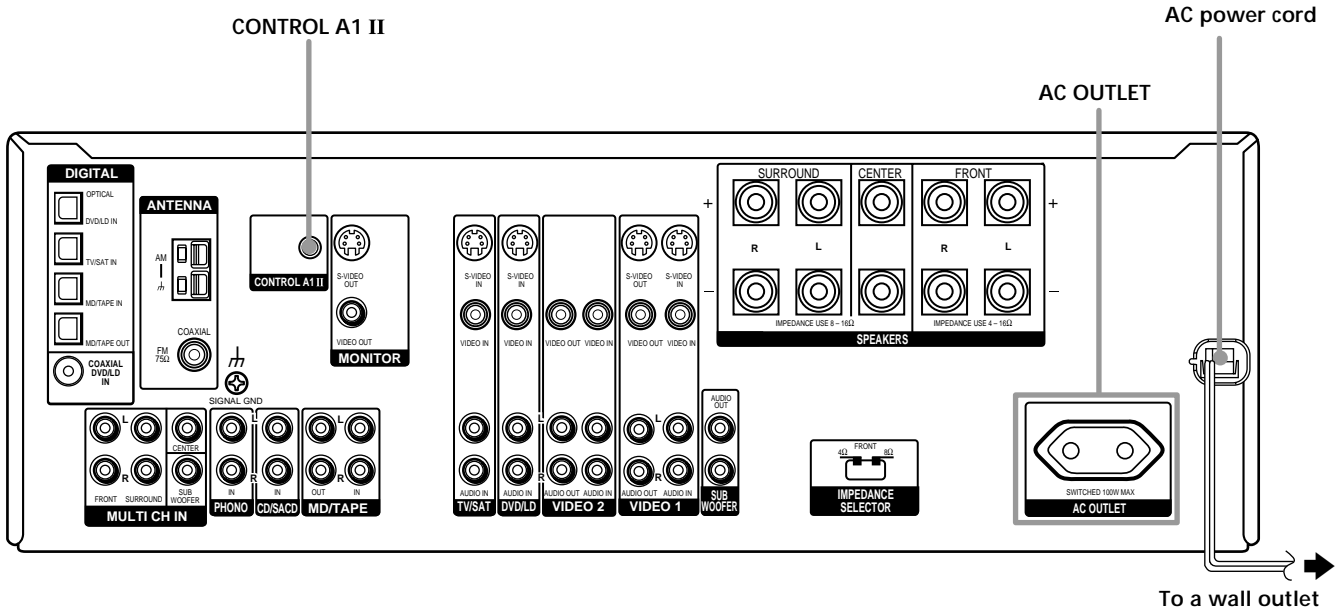

CONTROL A1 II hookup

- **If you have a CONTROL A1 II compatible Sony CD player, SACD player, tape deck, or MD deck**
Use a CONTROL A1 cord (not supplied) to connect the CONTROL A1 II jack on the CD player, SACD player, tape deck, or MD deck to the CONTROL A1 II jack on the receiver. Refer to “CONTROL A1II Control System” on page 52 and the operating instructions supplied with your CD player, SACD player, tape deck, or MD deck for details.

Note

If you make CONTROL A1 II connections from the receiver to an MD deck that is also connected to a computer, do not operate the receiver while using the “Sony MD Editor” software. This may cause a malfunction.

- **If you have a Sony CD changer with a COMMAND MODE selector**
If your CD changer’s COMMAND MODE selector can be set to CD 1, CD 2, or CD 3, be sure to set the command mode to “CD 1” and connect the changer to the CD jacks on the receiver.
If, however, you have a Sony CD changer with VIDEO OUT jacks, set the command mode to “CD 2” and connect the changer to the VIDEO 2 jacks on the receiver.

Connecting the AC power cord

Before connecting the AC power cord of this receiver to a wall outlet:

- Connect the speaker system to the receiver (see page 14).

Connect the AC power cord(s) of your audio/video components to a wall outlet.

If you connect other audio/video components to the AC OUTLET(s) on the receiver, the receiver will supply power to the connected component(s), allowing you to turn the whole system on or off when you turn the receiver on or off.

Caution

Make sure that the total power consumption of the component(s) connected to the receiver’s AC OUTLET(s) does not exceed the wattage stated on the rear panel. Do not connect high-wattage electrical home appliances such as electric irons, fans, or TVs to this outlet.

Hooking Up and Setting Up the Speaker System

This chapter describes how to hook up your speaker system to the receiver, how to position each speaker, and how to set up your speakers to enjoy multi channel surround sound.

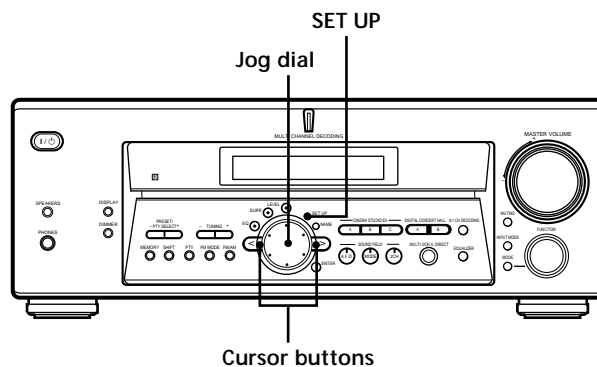

Brief descriptions of buttons and control used to set up the speaker system

SET UP button: Press to enter the setup mode when specifying speaker types and distances.

Cursor buttons (</>): Use to select parameters after pressing the SET UP button.

Jog dial: Use to adjust the setting of each parameter.

Speaker System Hookup

Required cords

Speaker cords (not supplied)

One for each front, surround, and center speaker



Monaural audio cord (not supplied)

One for an active sub woofer

Black Black

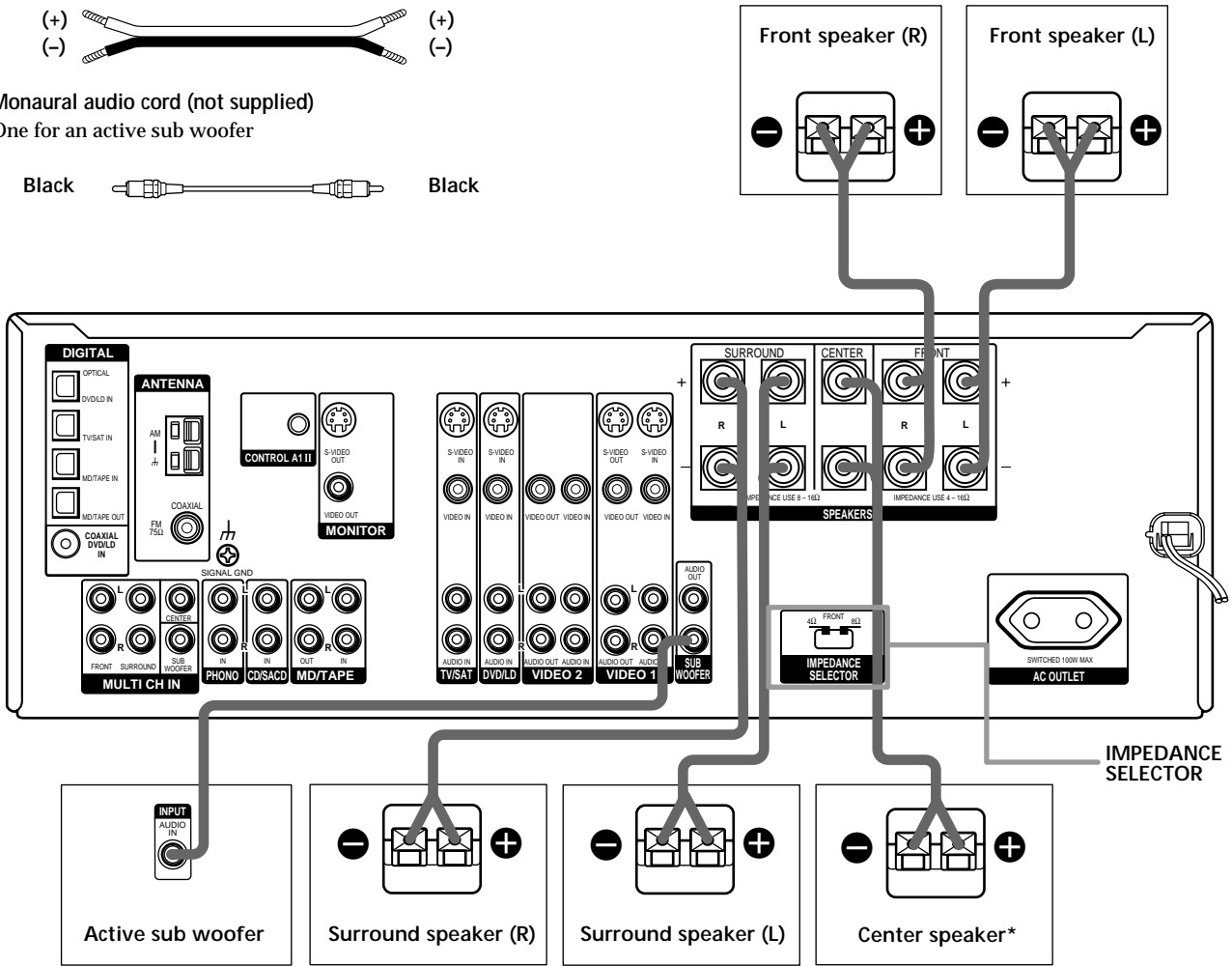

* You can connect a surround back speaker.

Terminals for connecting the speakers

Connect the	To the
Front speakers (8 or 4** ohm)	SPEAKERS FRONT terminals
Surround speakers (8 ohm)	SPEAKERS SURROUND terminals
Center speaker (8 ohm)	SPEAKERS CENTER terminals
Active sub woofer***	SUB WOOFER AUDIO OUT jack

** See "Speaker impedance" on the next page.

*** You can connect an active sub woofer to either of the two jacks. The remaining jack can be used to connect a second active sub woofer.

Notes on speaker system hookup

- Twist the stripped ends of the speaker cords about 10 mm (2/3 inch). Be sure to match the speaker cord to the appropriate terminal on the components: + to + and - to -. If the cords are reversed, the sound will be distorted and will lack bass.
- If you use speakers with low maximum input rating, adjust the volume carefully to avoid excessive output on the speakers.

To avoid short-circuiting the speakers

Short-circuiting of the speakers may damage the receiver. To prevent this, make sure to take the following precautions when connecting the speakers.

Make sure the stripped ends of each speaker cord do not touch another speaker terminal or the stripped end of another speaker cord.

Examples of poor conditions of the speaker cord

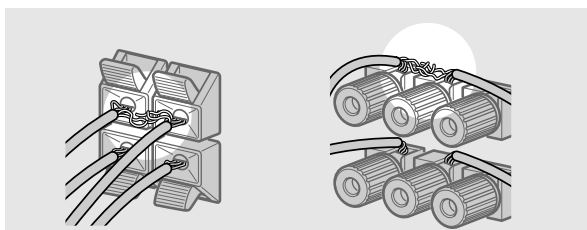

Stripped speaker cord is touching another speaker terminal.

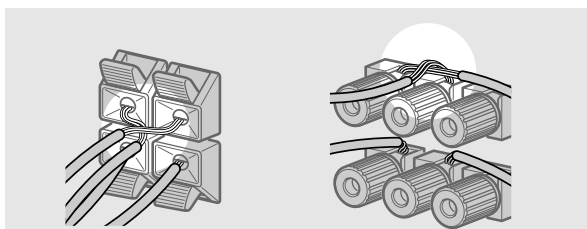

Stripped cords are touching each other due to excessive removal of insulation.

After connecting all the components, speakers, and AC power cord, output a test tone to check that all the speakers are connected correctly. For details on outputting a test tone, see page 21.

If no sound is heard from a speaker while outputting a test tone or a test tone is output from a speaker other than the one whose name is currently displayed on the receiver, the speaker may be short-circuited. If this happens, check the speaker connection again.

To avoid damaging your speakers

Make sure that you turn down the volume before you turn off the receiver. When you turn on the receiver, the volume remains at the level you turn off the receiver.

Speaker impedance

Set the IMPEDANCE SELECTOR for the front speakers as indicated in the table below. Check the instruction manual supplied with your speakers if you're not sure of their impedance. (This information is usually printed on a label on the back of the speaker.)

If the nominal impedance of your speaker is	Set IMPEDANCE SELECTOR to
Between 4 and 8 ohms	4Ω
8 ohms or higher	8Ω

Speakers connected to the SURROUND and CENTER SPEAKERS terminals must have a nominal impedance of 8 ohms or higher (regardless of the setting of the IMPEDANCE SELECTOR).

Note
Be sure to turn the power off when setting the IMPEDANCE SELECTOR.

Performing Initial Setup Operations

Once you have hooked up the speakers and turned on the power, clear the receiver's memory. Then specify the speaker parameters (size, position, etc.) and perform any other initial setup operations necessary for your system.

Clearing the receiver's memory

Before using your receiver for the first time, or when you want to clear the receiver's memory, do the following. This procedure is not necessary if the demonstration activates when you turn the power on.

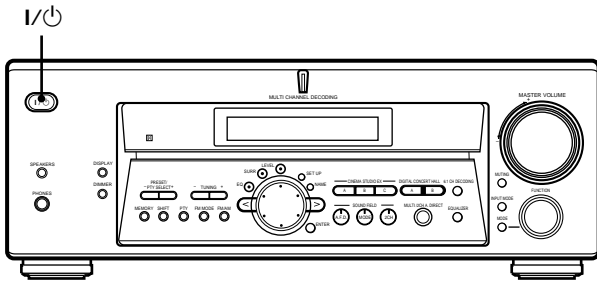

1 Turn off the receiver.

2 Hold down I/⏻ for 5 seconds.

The currently selected function, followed by the demonstration message appears in the display. All of the following items are reset or cleared:

- All preset stations are reset or cleared.
- All sound field parameters are reset to their factory settings.
- All index names (of preset stations and program sources) are cleared.
- All SET UP parameters are reset to their factory settings.
- The sound field memorized for each program source and preset stations are cleared.
- The MASTER VOLUME is set to VOLUME MIN.

Performing initial setup operations

Before using your receiver for the first time, adjust SET UP parameters so that the receiver correspond to your system. For the adjustable parameters, see the table on page 59. See pages 17–21 for speaker settings and pages 51–52 for other settings.

Demonstration Mode

The demonstration will activate the first time you turn on the power. When the demonstration starts, the following message appears in the display twice:

“Now Demonstration Mode!! To finish the demonstration, please press POWER KEY while this message appears in the display. Thank you!”

To cancel the demonstration

Press I/⏻ to turn the receiver off while the above message is being displayed. The next time you turn the receiver on, the demonstration will not appear.

To view the demonstration

Hold down SET UP and press I/⏻ to turn on the power.

Notes

- Running the demonstration will clear the receiver's memory. For details on what will be cleared, see “Clearing the receiver's memory” on this page.
- You cannot cancel demonstration if you did not press I/⏻ while the above message is being displayed. To cancel demonstration after the above message appears, press I/⏻ twice to activate the demonstration again. Then, press I/⏻ while the above message is being displayed.

Multi Channel Surround Setup

For the best possible surround sound all speakers should be the same distance from the listening position (A). However, this unit lets you to place the center speaker up to 1.5 meters (5 feet) closer (B) or the surround back speakers up to 4.5 meters (15 feet) closer (D) and the surround speakers up to 4.5 meters (15 feet) closer (C) to the listening position. The front speakers can be placed from 1.0 to 12.0 meters (3 to 40 feet) from the listening position (A).

You can place the surround speakers either behind you or to the side, depending on the shape of your room (etc.).

You can use the center speaker as a surround back speaker.

When placing surround speakers to your side

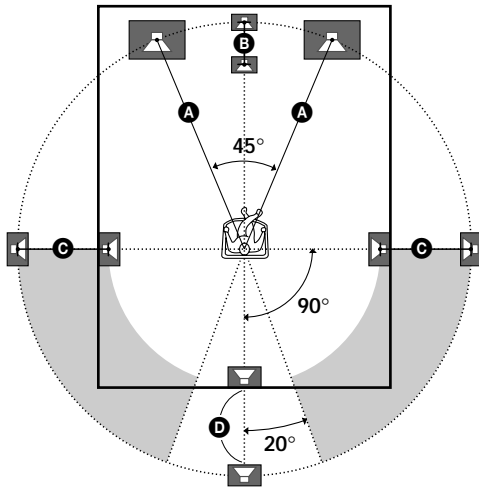

When placing the surround speakers behind you

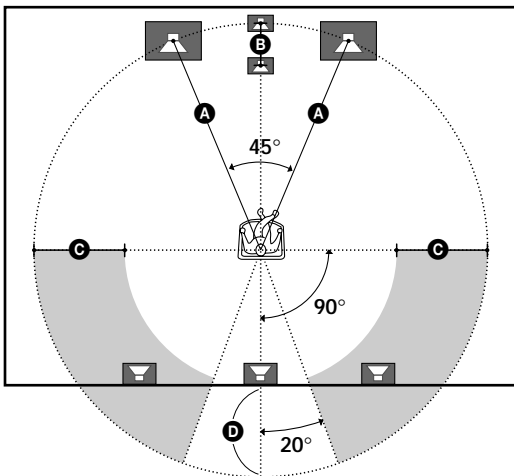

💡 When setting up the surround back speaker Set the speaker at least one meter behind the listening position. It is recommended to place the speaker at an equal distance from the surround left or right speakers. If there is no space behind the listening position, set the speaker above the listening position by placing it on a stand or hanging it from the ceiling. To prevent speaker damage or injury in case the speaker falls, make sure that it is properly fixed in place.

Note

Do not place the center speaker farther away from the listening position than the front speakers.

Specifying the speaker parameters

- 1 Press I/⏻ to turn on the receiver.
- 2 Press SET UP.
- 3 Press the cursor buttons (< or >) to select the parameter you want to adjust.
- 4 Turn the jog dial to select the setting you want. The setting is stored automatically.
- 5 Repeat steps 3 and 4 until you have set all of the parameters that follow.

■ **Front speaker size (FRONT)**

Initial setting : LARGE

- If you connect large speakers that will effectively reproduce bass frequencies, select "LARGE". Normally, select "LARGE".
- If the sound is distorted, or you feel a lack of surround effects when using multi channel surround sound, select "SMALL" to activate the bass redirection circuitry and output the front channel bass frequencies from the sub woofer.
- When the front speaker is set to "SMALL", the center, surround and surround back speakers are also automatically set to "SMALL" (unless previously set to "NO").

■ Center speaker size (CENTER)

Initial setting : LARGE

- If you connect a large speaker that will effectively reproduce bass frequencies, select "LARGE". Normally, select "LARGE". However, if the front speakers are set to "SMALL", you cannot set the center speaker to "LARGE".
- If the sound is distorted, or you feel a lack of surround effects when using multi channel surround sound, select "SMALL" to activate the bass redirection circuitry and output the center channel bass frequencies from the front speakers (if set to "LARGE") or sub woofer.*¹
- If you do not connect a center speaker, select "NO". The sound of the center channel will be output from the front speakers.*²

■ Surround speaker size (SURROUND)

Initial setting : LARGE

- If you connect large speakers that will effectively reproduce bass frequencies, select "LARGE". Normally, select "LARGE". However, if the front speakers are set to "SMALL", you cannot set the surround speakers to "LARGE".
- If the sound is distorted, or you feel a lack of surround effects when using multi channel surround sound, select "SMALL" to activate the bass redirection circuitry and output the surround channel bass frequencies from the sub woofer or other "LARGE" speakers.
- If you do not connect surround speakers, select "NO".*³

 *1~*3 correspond to the following Dolby Pro Logic modes

*¹ NORMAL

*² PHANTOM

*³ 3 STEREO

■ Surround back speaker size (SURR BACK)**

Initial setting : NO

This parameter can be set when the center speaker is set to "NO" and the surround speakers are set to "LARGE" or "SMALL".

- If you connect a large speaker that will effectively reproduce bass frequencies, select "LARGE". Normally, select "LARGE". However, if the front speakers are set to "SMALL", you cannot set the surround back speaker to "LARGE".
- If the sound is distorted, or you feel a lack of surround effects when using multi channel surround sound, select "SMALL" to activate the bass redirection circuitry and output the center channel bass frequencies from the front speakers (if set to "LARGE") or sub woofer. However, if the surround speakers are set to "SMALL", the surround back speaker is automatically set to "SMALL".
- If you do not connect a surround back speaker, select "NO".

**This parameter is not available when "Surround speaker size (SURROUND)" is set to "NO".

About speaker sizes (LARGE and SMALL)

Internally, the LARGE and SMALL settings for each speaker determine whether or not the internal sound processor will cut the bass signal from that channel. When the bass is cut from a channel the bass redirection circuitry sends the corresponding bass frequencies to the sub woofer or other "LARGE" speaker. However, since bass sounds have a certain amount of directionality it best not to cut them, if possible. Therefore, even when using small speakers, you can set them to "LARGE" if you want to output the bass frequencies from that speaker. On the other hand, if you are using a large speaker, but prefer not to have bass frequencies output from that speaker, set it to "SMALL".

If the overall sound level is lower than you prefer, set all speakers to "LARGE". If there is not enough bass, you can use the equalizer to boost the bass levels. To adjust the equalizer see page 36.

■ Sub woofer selection (SUB WOOFER)

Initial setting : YES

- If you connect a sub woofer, select "YES".
- If you do not connect a sub woofer, select "NO". This activates the bass redirection circuitry and outputs the LFE signals from other speakers.
- In order to take full advantage of the Dolby Digital bass redirection circuitry, we recommend setting the sub woofer's cut off frequency as high as possible.

■ Front speaker distance (FRONT XX.X)

Initial setting : 5.0 meter (16 feet)

Set the distance from your listening position to the front (left or right) speaker (A on page 17).

■ Center speaker distance (CENTER XX.X)

Initial setting : 5.0 meter (16 feet)

Set the distance from your listening position to the center speaker. Center speaker distance should be set from a distance equal to the front speaker distance (A on page 17) to a distance 1.5 meters (5 feet) closer to your listening position (E on page 17). When this range is exceeded, the display blinks. If you make the setting while the display blinks, you cannot fully enjoy the surround effect.

■ Surround speaker distance (SURROUND XX.X)

Initial setting : 3.5 meter (11 feet)

Set the distance from your listening position to the surround speaker. Surround speaker distance should be set from a distance equal to the front speaker distance (A on page 17) to a distance 4.5 meters (15 feet) closer to your listening position (C on page 17). When this range is exceeded, the display blinks. If you make the setting while the display blinks, you cannot fully enjoy the surround effect.

■ Surround back speaker distance (SURR BACK XX.X)

Initial setting : 3.5 meter (11 feet)

Set the distance from your listening position to the surround back speaker. Surround back speaker distance should be set from a distance equal to the front speaker distance (A on page 17) to a distance 4.5 meters (15 feet) closer to your listening position (D on page 17). When this range is exceeded, the display blinks. If you make the setting while the display blinks, you cannot fully enjoy the surround effect.

■ Sub woofer distance (SUB WOOFER XX.X)

Initial setting : 5.0 meter (16 feet)

Set the distance from your listening position to the sub woofer.

**About speaker distances**

This receiver allows you to input the speaker position in terms of distance. However, it is not possible to set the center speaker farther away than the front speakers. Also, the center speaker can not be set more than 1.5 meters (5 feet) closer than the front speakers.

Likewise, the surround and surround back speakers cannot be set farther away from the listening position than the front speakers. And they can be no more than 4.5 meters (15 feet) closer.

This is because incorrect speaker placement is not conducive to enjoy the surround sound.

Please note that, setting the speaker distance closer than the actual location of the speakers will cause a delay in the output of the sound from that speaker. In other words, the speaker will sound like it is farther away.

For example, setting the center speaker distance 1~2 m (3~6 feet) closer than the actual speaker position will create a fairly realistic sensation of being "inside" the screen. If you cannot obtain a satisfactory surround effect because the surround speakers are too close, setting the surround speaker distance closer (shorter) than the actual distance will create a larger soundstage.

Adjusting these parameters while listening to the sound often results in much better surround sound. Give it a try!

■ Sub woofer phase polarity (S.W PHASE)

Initial setting : NORMAL

Set the sub woofer phase polarity. There is usually no problem when the sub woofer phase polarity is set to "NORMAL". However, depending on the type of front speakers, the position of the sub woofer, and the cut-off frequency of the sub woofer, setting the phase polarity to "REVERSE" may produce better bass. Besides bass reproduction, the richness and tightness of the overall sound may also be affected. While listening from the main listening position, select the setting that best suits your environment.

■ Distance unit (DISTANCE UNIT)

Initial setting : meter (feet)

Lets you select either meters or feet as the unit of measure for setting distances.

Multi Channel Surround Setup

■ Surround speaker position (SURR POSI.)*

Initial setting : SIDE

This parameter lets you specify the location of your surround speakers for proper implementation of the Digital Cinema Sound surround modes in the "VIRTUAL" sound fields. Refer to the illustration below.

- Select "SIDE" if the location of your surround speakers corresponds to section **A**.
- Select "MIDDLE" if the location of your surround speakers corresponds to section **B**.
- Select "BEHIND"*** if the location of your surround speakers corresponds to section **C**.

This setting only effects the surround modes in the "VIRTUAL" sound fields.

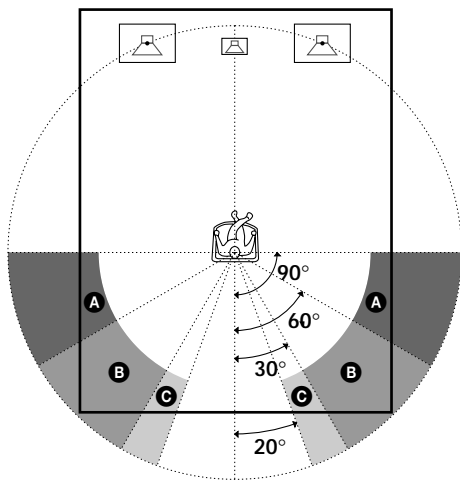

- * These parameters are not available when "Surround speaker size" is set to "NO".
- ** This parameter is only available when "Surround back speaker size" is set to "NO".

■ Surround speaker height (SURR HEIGHT)* / Surround back speaker height (SURR BACK HGT.)***

Initial setting : LOW

This parameter lets you specify the height of your surround and surround back speakers for proper implementation of the Digital Cinema Sound surround modes in the "VIRTUAL" sound fields. Refer to the illustration below.

- Select "LOW" if the location of your surround speakers corresponds to section **A**.
- Select "HIGH" if the location of your surround speakers corresponds to section **B**.

This setting only affects the surround modes in the "VIRTUAL" sound fields.

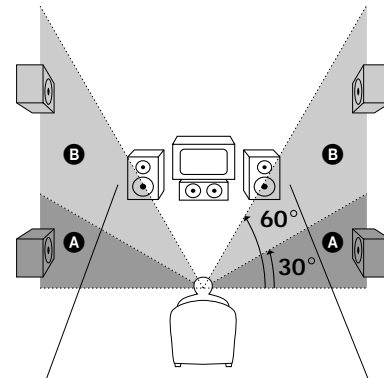

- * These parameters are not available when "Surround speaker size" is set to "NO".
- *** This parameter is not available when "Surround back speaker size" is set to "NO".

💡 About the surround speaker position (SIDE, MIDDLE and BEHIND)

This setting is designed specifically for implementation of the Digital Cinema Sound modes in the "VIRTUAL" sound fields. With the Digital Cinema Sound modes, speaker position is not as critical as other modes. All of the modes in the "VIRTUAL" sound fields were designed under the premise that the surround speaker would be located behind the listening position, but presentation remains fairly consistent even with the surround speakers positioned at a rather wide angle. However, if the speakers are pointing towards the listener from the immediate left and right of the listening position, the "VIRTUAL" sound fields will not be effective unless the surround speaker position parameter is set to "SIDE".

Nevertheless, each listening environment has many variables, such as wall reflections, and you may obtain better results using "BEHIND" or "MIDDLE" if your speakers are located high above the listening position, even if they are to the immediate left and right.

Therefore, although it may result in a setting contrary to the "Surround speaker position" explanation, we recommend that you play back multi channel surround encoded software and listen to the effect each setting has on your listening environment. Choose the setting that provides a good sense of spaciousness and that best succeeds in forming a cohesive space between the surround sound from the surround speakers and the sound from the front speakers. If you are not sure which sounds best, select "BEHIND" and then use the speaker distance parameter and speaker level adjustments to obtain proper balance.

■ Front speaker crossover frequency (FRONT SP > XXX Hz)

Initial setting : STD (120Hz)

Lets you adjust the front speaker bass crossover frequency when the front speakers are set to "SMALL".

■ Center speaker crossover frequency (CENTER SP > XXX Hz)

Initial setting : STD (120 Hz)

Lets you to adjust the center speaker bass crossover frequency when the center speaker is set to "SMALL".

■ Surround speaker crossover frequency (SURROUND SP > XXX Hz)

Initial setting : STD (120 Hz)

Lets you adjust the surround speaker bass crossover frequency when the surround speakers are set to "SMALL".

■ Surround back crossover frequency (SURR BACK SP > XXX Hz)

Initial setting : STD (120 Hz)

Lets you adjust the surround back speaker bass crossover frequency when the surround back speaker is set to "SMALL".

■ LFE high cut filter (LFE HIGH CUT > XXX Hz)

Initial setting : STD (120 Hz)

Lets you select the cut off frequency of the LFE channel high cut filter. Normally, select "STD". When using a passive subwoofer powered by a separate power amplifier, it may be better to change the cut off frequency. When this is the case, use a setting other than STD.

Adjusting the speaker level

Use the remote while seated in your listening position to adjust the level of each speaker.

Note

This receiver incorporates a new test tone with a frequency centered at 800 Hz for easier speaker level adjustment.

- 1 Press I/⏻ to turn on the receiver.
- 2 Press TEST TONE on the remote. "TEST TONE" appears in the display and you will hear the test tone from each speaker in sequence.

- 3 To change the test tone mode, press MENU +/- to select the mode you want.

Mode	The test tone output
NORMAL	The test tone is output from each speaker in sequence.
PHASE	The test tone is output from two speakers at a time in sequence. (There is no sound output from the sub woofer.) You can also adjust the balance between speakers.
2CH SWAP	You can adjust the speaker levels while listening to the source (not the test tone). Turn on the connected component, start playing, then turn FUNCTION to select the component (except connected to the MULTI CH IN jacks). The sound for the front L/R speakers is output from the surround R/L speakers. You can adjust the level of surround speakers from the listening position.

Note

You cannot select "2CH SWAP" when "2CH A. DIRECT" is selected (15 on page 26).

- 4 Adjust the LEVEL parameters so that the level of the test tone from each speaker sounds the same when you are in your main listening position. Press LEVEL to adjust the balance and level of speakers. For details on the LEVEL menu, see page 35. While adjusting, the test tone is output from the speaker whose adjustment is performed.

- 5 Press TEST TONE again to turn off the test tone.

Tip

You can adjust the level of the all speakers at the same time. Turn MASTER VOLUME on the main unit or press MASTER VOL +/- on the remote.

Notes

- The adjusted value are shown in the display during adjustment.
- Although these adjustments can also be made via the front panel using the LEVEL menu (when the test tone is output, the receiver switches to the LEVEL menu automatically), we recommend you to follow the procedure described above and adjust the speaker levels from your listening position using the remote.

Before You Use Your Receiver

Checking the connections

After connecting all of your components to the receiver, do the following to verify that the connections were made correctly.

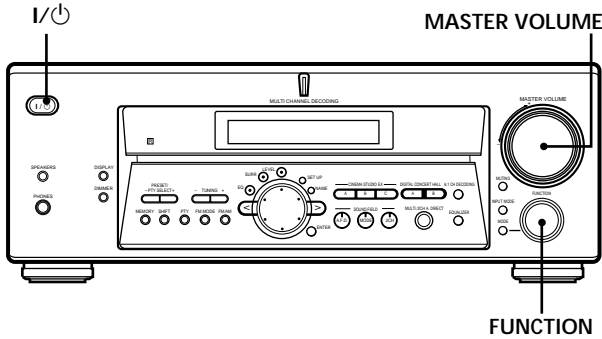

- 1 Press I/⏻ to turn on the receiver.
- 2 Turn on the component that you connected (e.g., CD player or tape deck).
- 3 Rotate FUNCTION to select a component (program source) and start playing it.
- 4 Rotate MASTER VOLUME to turn up the volume.

If you do not obtain normal sound output after performing this procedure, look for the reason in the following checklist and take the appropriate measures to correct the problem.

There is no sound no matter which component is selected.

- ➔ Check that both the receiver and all components are turned on.
- ➔ Check that the volume level on the display is not set to VOLUME MIN by turning the MASTER VOLUME.
- ➔ Press SPEAKERS button if SP. OFF appears on the display.
- ➔ Check that all speaker cords are connected correctly.
- ➔ Press MUTING if MUTING appears on the display.
- ➔ Check that the headphones are not connected to the PHONES jack. No sound will come from the speakers if the headphones are connected.
- ➔ Check that the receiver is not in "Demonstration Mode" (see page 16).

There's no sound from a specific component.

- ➔ Check that the component is connected correctly to the audio input jacks for that component.
- ➔ Check that the cord(s) used for the connection is (are) fully inserted into the jacks on both the receiver and the component.

No sound is heard from one of the front speakers.

- ➔ Connect a pair of headphones to the PHONES jack to verify that sound is output from the headphones (see "[24] SPEAKERS button" and "PHONES jack" on page 27).

If only one channel is output from the headphones, the component may not be connected to the receiver correctly. Check that all the cords are fully inserted into the jacks on both the receiver and the component.

If both channels are output from the headphones, the front speaker may not be connected to the receiver correctly. Check the connection of the front speaker which is not outputting any sound.

If you encounter a problem that is not included above, see "Troubleshooting" on page 54.

Location of Parts and Basic Operations

This chapter provides information about the locations and functions of the buttons and controls on the front panel. It also explains basic operations.

Front Panel Parts Description

1 I/⏻ switch

Press to turn the receiver on and off.

2 DISPLAY button

Press repeatedly to change the information on the display window as follows:

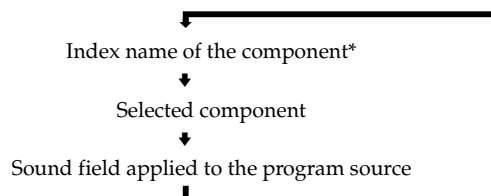

When the tuner is selected

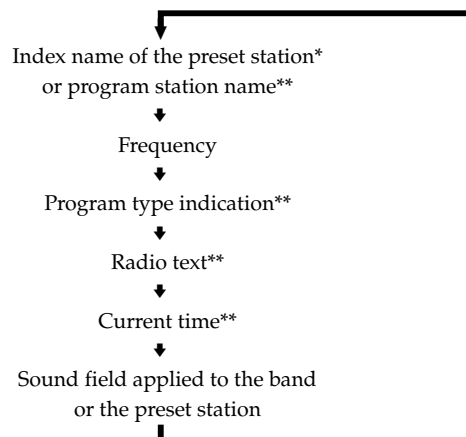

* Index name appears only when you have assigned one to the component or preset station (see page 49). Index name does not appear when only blank spaces have been entered, or it is the same as the function button.

** These indications appear only during RDS reception. (See page 46).

Front Panel Parts Description

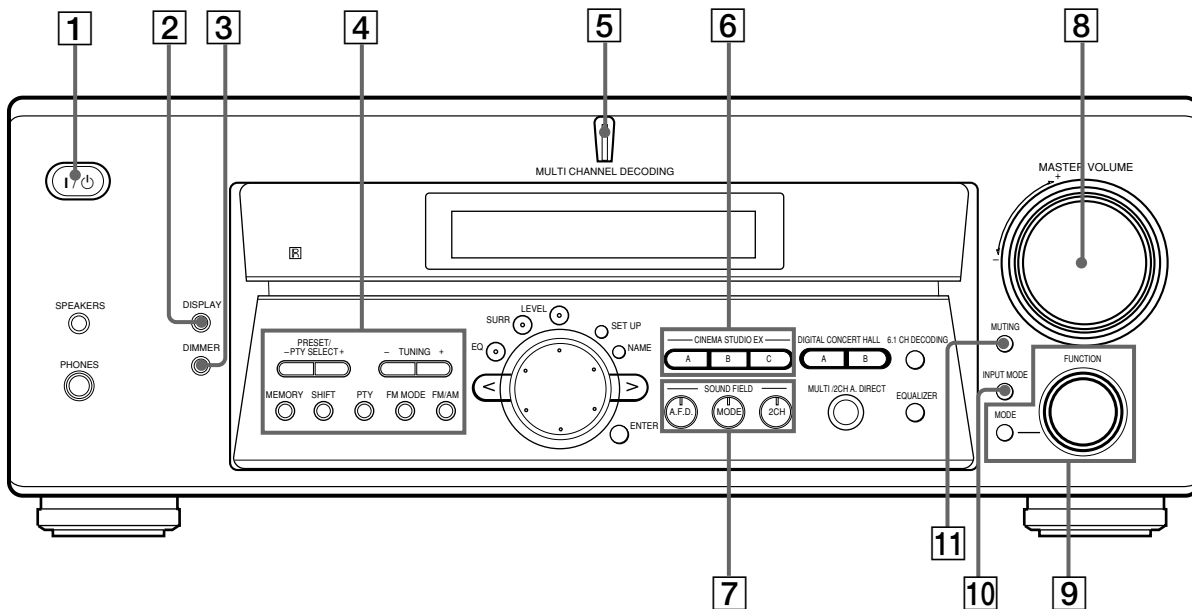

3 DIMMER button

Press DIMMER repeatedly to adjust the brightness of the display (5 steps).

When set to the dimmest setting, the display and the blue LED are turned off. However, when you press any button, the display becomes the brightest setting temporary.

- 4 The following buttons operate the built-in tuner. For details, see "Receiving Broadcasts" starting from page 42.

PRESET /PTY PRESET +/- buttons

Scan all preset stations.

Select program types during PTY operations.

TUNING +/- buttons

Scan all the available radio stations.

MEMORY button

Press to memorize a preset station.

SHIFT button

Selects a memory page for preset stations.

PTY button

Press to scan stations by program type. The PTY button does not function during AM reception.

FM MODE button

If "STEREO" flashes in the display and the FM stereo reception is poor, press this button. You will not have the stereo effect but the sound is improved.

FM/AM button

Selects the FM or AM band.

5 MULTI CHANNEL DECODING indicator

This indicator lights up when the unit is decoding signals recorded in a multi channel format.

- 6 Use the CINEMA STUDIO EX buttons to enjoy the CINEMA STUDIO EX sound effects.

A/B/C buttons

Press to activate the CINEMA STUDIO EX A, B or C sound field (page 30).

- 7 Use the SOUND FIELD buttons to enjoy surround sound. For details, see "Enjoying Surround Sound" starting from page 28.

A.F.D. button / indicator

Press to set the receiver to automatically detect the type of audio signal being input and perform proper decoding (if necessary).

MODE button / indicator

Press to activate the sound field selection mode (page 29).

2CH button / indicator

Press to output sound from only the front (left and right) speakers.

8 MASTER VOLUME control

After turning on the component you selected, rotate to adjust the volume.

9 FUNCTION control

Rotate to select the component you want to use.

To select	Rotate to display
VCR	VIDEO 1 or VIDEO 2
DVD or LD player	DVD/LD
TV or satellite tuner	TV/SAT
MD or Tape deck	MD/TAPE
CD or SACD player	CD/SACD
Built in tuner	TUNER
Turntable	PHONO

After selecting the component, turn on the component you selected and play the program source.

- After selecting VCR, DVD player, or LD player, turn on the TV and set the TV's video input to match the component you selected.

MODE button

Press to select and play another video/audio source in combination with the selected component.

Each time you press the button, the display changes as follows:

Standard display

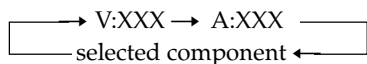

Press MODE to display	And rotate FUNCTION to select
V:XXX	Any video source to enjoy with the audio from the selected component
A:XXX	Any audio source to enjoy with the video from the selected component

10 INPUT MODE button

Press INPUT MODE to select the input mode for your digital components. Each time you press the button, the input mode of the currently selected component switches.

Select	To
AUTO 2CH	Give priority to the analog audio signals input to the AUDIO IN (L/R) jacks when there is no digital signals.
COAXIAL FIXED	Specify the digital audio signals input to the DIGITAL COAXIAL input jacks.

Select	To
OPTICAL FIXED	Specify the digital audio signals input to the DIGITAL OPTICAL input jacks.
ANALOG 2CH FIXED	Specify the analog audio signals input to the AUDIO IN (L/R) jacks.

When the MULTI CH is assigned to a specific function using SET UP menu (page 51), "AUTO MULTI CH" and "MULTI CH FIXED" are displayed instead of "AUTO 2CH" and "ANALOG 2CH FIXED".

Select	To
AUTO MULTI CH	Give priority to the analog audio signals input to the MULTI CH IN jacks when there is no digital signals.
MULTI CH FIXED	Specify the analog audio signals input to the MULTI CH IN jacks.

11 MUTING button

Press to mute the sound. MUTING appears in the display when the sound is muted.

Front Panel Parts Description

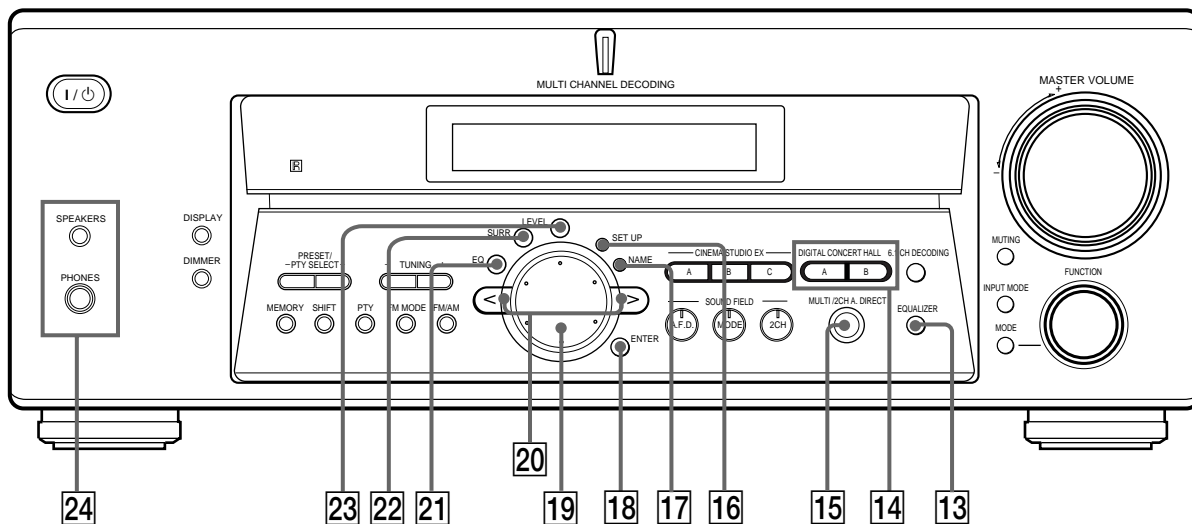

Location of Parts and Basic Operations

12 6.1 CH DECODING button

Press 6.1 CH DECODING to adjust the 6.1 channel matrix parameter in the SET UP menu (page 51). This function works only for the multi channel format [3/2].

This function is effective for the following sound fields.

- A.F.D.*
- NORMAL SURROUND
- CINEMA STUDIO EX A-C
- SEMI CINEMA STUDIO EX A-C
- NIGHT THEATER
- MONO MOVIE
- STEREO MOVIE
- V. MULTI DIMENSION
- VIRTUAL MULTI REAR
- V. SEMI M. DIMENSION
- VIRTUAL ENHANCED A, B

* "AUTO" only.

About the "VIRTUAL MATRIX 6.1" playback

Though this receiver incorporates the 5.1 channel amplifier, you can reproduce the 6.1 channel surround sound of the sources encoded in 6.1 channel (page 29).

To enjoy "VIRTUAL MATRIX 6.1" playback most effectively, use the 6.1CH DECODING function when you select "CINEMA STUDIO EX A-C" or "SEMI CINEMA STUDIO EX A-C". The sound characteristics of CINEMA STUDIO and the 3D sound imaging create the virtual surround back speaker, and you can enjoy the surround effect as if in the real theater. You can select AUTO/ON/OFF using the 6.1CH DECODING button (page 51).

13 EQUALIZER button

Press to turn the equalizer on or off. The EQ indicator in the display lights when the equalizer is turned on. When you adjust the equalizer using the EQ parameters (page 36), the settings are stored automatically and can be reproduced wherever you turn on the equalizer.

- The equalizer is not compatible with 96 kHz digital audio signals and during MULTI CH IN input or 2CH ANALOG DIRECT.

14 DIGITAL CONCERT HALL buttons

Use the DIGITAL CONCERT HALL buttons to enjoy the DIGITAL CONCERT HALL sound effects.

A/B buttons

Press to activate the DIGITAL CONCERT HALL A or B sound field (page 30).

15 MULTI/2CH A. DIRECT button

Press MULTI/2CH A. DIRECT to enjoy the audio source connected to the MULTI CH IN jacks or analog 2 channel input jacks. Only volume control and the front speaker balance can be adjusted when set to 2CH ANALOG DIRECT. When set to MULTI DIRECT, you can adjust balance and level of all the speakers. When this function is on, the surround effects are turned off.

Select	To
MULTI	Enjoy the audio source connected to the MULTI CH IN jacks. MULTI CH IN indicator lights up in the display. This mode is suitable for enjoying high quality analog source.
2CH A. DIRECT	Enjoy the audio source connected to analog 2 channel jacks. This mode is suitable for enjoying high quality analog source.

16 SET UP button

Press to activate the setup mode, then use the cursor buttons (20) to select any of the following parameters. You can make various settings using the jog dial (19). For details, see "Adjustment Using the SET UP Button" starting from page 51.

17 NAME button

Press to activate the name function and enter names for preset stations and program sources (page 49).

18 ENTER button

Press to enter individual characters for the preset station and program source names.

19 Jog dial

Turn to adjust the selected speaker level, surround, and equalizer parameters (etc.).

20 Cursor buttons (</>)

Press to select various speaker level, surround, and equalizer parameters (etc.).

21 EQ button

Press to activate the equalizer parameters (page 36). The indicator on the button lights up and you can adjust the various equalizer parameters.

22 SURR button

Press to activate the surround parameters (page 34). The indicator on the button lights up and you can adjust the various surround parameters (effect level, wall type, etc.).

23 LEVEL button

Press to activate the speaker level parameters (page 35). The indicator on the button lights up and you can adjust the various speaker level parameters (front balance, surround balance, etc.).

24 SPEAKERS button

Press SPEAKERS button to ON. Press again to OFF.

PHONES jack

Connects headphones.

- When you connect the headphones, no sound will come from the speakers and "SP. OFF" lights up in the display.

Enjoying Surround Sound

This chapter describes how to set up the receiver to enjoy surround sound. You can enjoy multi channel surround when playing back software encoded with Dolby Digital or DTS.

You can take advantage of surround sound simply by selecting one of the receiver's pre-programmed sound modes. They bring the exciting and powerful sound of movie theaters and concert halls into your home. You can also customize the sound modes to obtain the sound you desire by changing the various surround parameters. The receiver contains a variety of different sound modes. The cinema sound modes are designed for use when playing back movie software (DVD, LD, etc.) encoded with multi channel surround sound or Dolby Pro Logic. In addition to decoding the surround sound, some of these modes also provide sound effects commonly found in movie theaters.

The virtual sound modes contain compelling applications of the Sony Digital Cinema Sound digital signal processing technology. They shift the sound away from the actual speaker locations to simulate the presence of several "virtual" speakers.

The music (etc.) sound modes are designed for use with standard audio sources and TV broadcasts. They add reverberation to the source signal to make you feel as if you were in a concert hall or stadium (etc.). Use these sound modes with two-channel sources like CD and stereo broadcasts of sports programs or musical concerts. For more information about the sound modes, see pages 30~31.

A.F.D.

The "Auto Format Decoding" sound mode presents the sound exactly as it was encoded, without adding any reverberation (etc.).

DCS (Digital Cinema Sound)

The sound fields with DCS marks use DCS technology. When these sound fields are selected, "Digital Cinema Sound" indicator in the display lights up.

DCS is the concept name of the surround technology for home theater developed by Sony. DCS uses the DSP (Digital Signal Processor) technology to reproduce the sound characteristics of an actual cinema cutting studio in Hollywood.

To fully enjoy surround sound, you must register the number and location of you speakers. See "Multi Channel Surround setup" starting on page 17 to set the speaker parameters before enjoying surround sound.

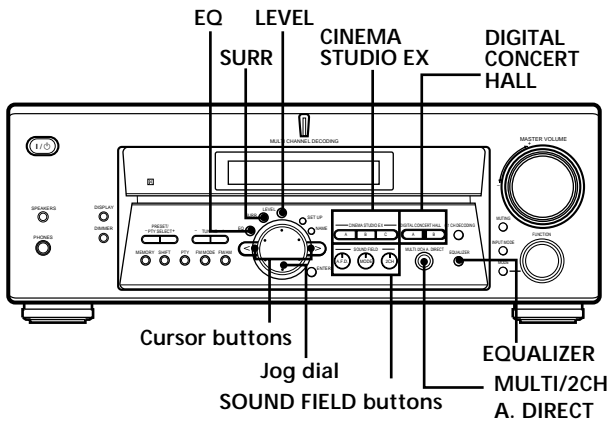

Brief descriptions of buttons used to enjoy surround sound

LEVEL button: Press to customize the level parameters.

SURR button: Press to customize the surround parameters in the current sound field.

EQ button: Press to customize the equalizer parameters in the current sound field.

Cursor buttons (</>): Use to select parameters after pressing the LEVEL, SURR, EQ or SET UP buttons.

Jog dial: Use to adjust parameters and select sound fields (etc.).

SOUND FIELD buttons:

A.F.D. button: Press to set the receiver to automatically detect the type of audio signal being input and perform proper decoding (if necessary).

MODE button: Press to activate the sound field selection mode.

2CH button: Press to output sound from only the front (left and right) speakers.

EQUALIZER button: Turns the equalizer on or off.

CINEMA STUDIO EX buttons: Press to select CINEMA STUDIO EX A~C sound field.

MULTI/2CH A. DIRECT button: Press to input the analog signal without digital processing. When this function is on, the equalizer and sound field (etc.) are turned off.

DIGITAL CONCERT HALL buttons: Press to select DIGITAL CONCERT HALL A ~ B sound field.

Selecting a Sound Field

You can enjoy surround sound simply by selecting one of the pre-programmed sound fields according to the program you want to listen to.

- 1 Press **SOUND FIELD MODE**.
The current sound field is indicated in the display.
- 2 Turn the jog dial or press the cursor buttons (< or >) to select the sound field you want.
See pages 30–31 for information on each sound field.

To turn the sound field off

Press A.F.D., 2CH or MULTI/2CH A. DIRECT (page 31).

Tip

When sound signals with a sampling frequency of 96 kHz are input, the sound signals are output in stereo automatically, and the sound field is turned off.

You can identify the encoding format of program software by looking at its packaging

Dolby Digital discs are labeled with the logo, and Dolby Surround encoded programs are labeled with the logo.

6.1 channel matrix decoding

Some movies released after the summer of 1999 added a new channel to its preexisting 5.1 channel. The new channel added speakers behind the listening position. In the movie theaters, these speakers are placed on the rear wall, on each side of the projection room's window.

The 6.1 channel system used in the movie theaters is called Dolby Surround EX system. However, to record on movie films, this 6.1 channel is converted to 5.1 channel using matrix encoding, and the same number of channels are used as Dolby Digital and DTS recordings. Recordings on the DVD also use the same signals. A lot of movie theaters screen movie with matrix encoded 5.1 channel signals and this is not unnatural to the ears. However, when a matrix decoder is used to create surround center speaker signals, this simulates the same 6.1 channel sound as Dolby Surround EX system in the movie theaters.

This unit is equipped with the matrix decoder allowing for 6.1 channel sound production. With Virtual 3D technology, the surround back signals can be enjoyed even without an actual surround back speaker. When the center speaker is not used, it is possible to use this channel to output surround back signals. Particularly with 6.1 CH DECODING, speakers placed on rear and side walls in the movie theaters are virtually created. As reflections and reverberations are also simulated, you can enjoy powerful sounds as if in the movie theater that uses Dolby Surround EX system.

Sound field information

■ NORMAL SURROUND

Software with multi channel surround audio signals is played back according to the way it was recorded.

Software with 2 channel audio signals is decoded with Dolby Pro Logic to create surround effects.

■ CINEMA STUDIO EX A-C¹⁾²⁾ DCS

Uses 3D sound imaging of V. MULTI DIMENSION to create 5 sets of virtual speakers surrounding the listener from a single pair of actual surround speakers.

You can reproduce the 6.1 channel surround sound by creating the virtual surround back speaker through the "VIRTUAL MATRIX 6.1" playback function (12 on page 26).

- CINEMA STUDIO EX A reproduces the sound characteristics of Sony Pictures Entertainment's classic editing studio.
- CINEMA STUDIO EX B reproduces the sound characteristics of Sony Pictures Entertainment's mixing studio which is one of the most up-to-date facilities in Hollywood.
- CINEMA STUDIO EX C reproduces the sound characteristics of Sony Pictures Entertainment's BGM recording studio.

■ SEMI CINEMA STUDIO EX A-C¹⁾ DCS

Uses 3D sound imaging of V. SEMI M. DIMENSION to create 5 sets of virtual speakers surrounding the listener from the sound of the front speakers (without using actual surround speakers).

You can reproduce the 6.1 channel surround sound by creating the virtual surround back speaker through the "VIRTUAL MATRIX 6.1" playback function (12 on page 26).

- SEMI CINEMA STUDIO EX A reproduces the sound characteristics of Sony Pictures Entertainment's classic editing studio.
- SEMI CINEMA STUDIO EX B reproduces the sound characteristics of Sony Pictures Entertainment's mixing studio which is one of the most up-to-date facilities in Hollywood.
- SEMI CINEMA STUDIO EX C reproduces the sound characteristics of Sony Pictures Entertainment's BGM recording studio.

■ NIGHT THEATER

Allows you to retain a theater like environment while listening at low volume levels, such as late at night.

■ MONO MOVIE

Creates a theater like environment from movies with monaural soundtracks.

■ STEREO MOVIE

Creates a theater like environment from movies recorded with stereo soundtracks.

■ V. MULTI DIMENSION¹⁾ (Virtual Multi Dimension) DCS

Uses 3D sound imaging to create an array of virtual surround speakers positioned higher than the listener from a single pair of actual surround speakers. This mode creates 5 sets of virtual speakers surrounding the listener at approximately a 30° angle of elevation.

■ VIRTUAL MULTI REAR¹⁾ (Virtual Multi Rear) DCS

Uses 3D sound imaging to create 3 sets of virtual surround speakers from 1 set of actual surround speakers.

■ V. SEMI M. DIMENSION¹⁾ (Virtual Semi Multi Dimension) DCS

Uses 3D sound imaging to create virtual surround speakers from the sound of the front speakers without using actual surround speakers. This mode creates 5 sets of virtual speakers surrounding the listener at a 30° angle of elevation.

■ VIRTUAL ENHANCED A¹⁾ (Virtual Enhanced Surround A) DCS

Uses 3D sound imaging to create 3 sets of virtual surround speakers from the sound of the front speakers without using actual surround speakers.

■ VIRTUAL ENHANCED B¹⁾ (Virtual Enhanced Surround B) DCS

Uses 3D sound imaging to create 1 set of virtual surround speakers from the sound of the front speakers without using actual surround speakers.

■ DIGITAL CONCERT HALL A, B²⁾

Reproduces the acoustics of a concert hall using multi-speaker system and 3D sound imaging for software with 2 channel signals like CDs.

- DIGITAL CONCERT HALL A reproduces the sonic character of the CONCERTGEBOUW in Amsterdam, which is famous for its large sound stage due to its reflectivity.
- DIGITAL CONCERT HALL B reproduces the sonic character of the MUSIKVEREIN in Vienna, which is famous for its hall resonance and unique reverberative sound.

■ CHURCH

Reproduces the acoustics of a stone church.

■ OPERA HOUSE

Reproduces the acoustics of an opera house.

■ JAZZ CLUB

Reproduces the acoustics of a jazz club.

■ DISCO/CLUB

Reproduces the acoustics of a discotheque/dance club.

■ LIVE HOUSE

Reproduces the acoustics of a 300-seat live house.

■ ARENA

Reproduces the acoustics of a 1000-seat concert hall.

■ STADIUM

Reproduces the feeling of a large open-air stadium.

■ GAME

Obtains maximum audio impact from video game software.

When headphones are connected, you can select the following sound fields only:

■ HEADPHONE (2CH)

Outputs the sound in 2 channel (stereo). Standard 2 channel (stereo) sources completely bypass the sound field processing. Multi channel surround formats are downmixed to 2 channel.

■ HEADPHONE (DIRECT)

Outputs the analog signals without digital processing by the equalizer, sound field, etc.

■ HEADPHONE THEATER

Allows you to experience a theater like environment while listening through a pair of headphones.

¹⁾ "VIRTUAL" sound field: Sound field with virtual speakers. However, turning the SURROUND menu "VIRTUAL SPEAKERS" parameter off when using "CINEMA STUDIO EX A-C" or "SEMI CINEMA STUDIO EX A-C" reproduces the sound characteristics of each cinema production studio without virtual speakers.

²⁾ You can select by pressing the buttons on the front panel.

Notes

- The effects provided by the virtual speakers may cause increased noise in the play back signal.
- When listening to sound fields that employ the virtual speakers, you will not be able to hear any sound coming directly from the surround speakers.

Use the buttons on the front panel to operate the following modes.

A.F.D. (Auto Format Decoding)

Automatically detects the type of audio signal being input (Dolby Digital, DTS, Dolby Pro Logic, or standard 2 channel stereo) and performs the proper decoding if necessary. This mode presents the sound as it was recorded/encoded, without adding any effects (ex. reverberation.)

2CH (2 Channel)

Outputs the sound from the front left and right speakers only. Standard 2 channel (stereo) sources completely bypass the sound field processing. Multi channel surround formats are downmixed to 2 channel.

MULTI/2CH A. DIRECT (Multi/2 CH Analog Direct)

The analog input signal is not digitally processed. You can enjoy high quality analog source. Only volume control and the front speaker balance can be adjusted when set to 2CH A. DIRECT. When set to MULTI DIRECT, you can adjust balance and level of all the speakers. When this function is on, the equalizer, sound field (etc.) are turned off.

Note

No sound is output from the sub woofer when the 2 CHANNEL mode is selected. To listen to two channel (stereo) sources using the front left and right speakers and a sub woofer, use the AUTO FORMAT DECODING mode.

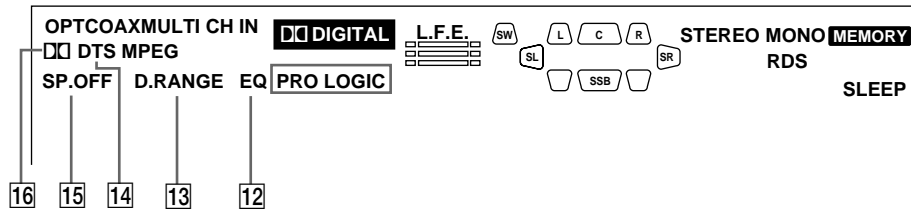

12 EQ

Lights when the equalizer functions.

13 D. RANGE

Lights up when dynamic range compression is active.
See page 35 to adjust the dynamic range compression.

14 DTS

Lights up when DTS signals are input.

Note

When playing a DTS format disc, be sure that you have made digital connections and that INPUT MODE is NOT set to ANALOG (see **10** on page 25).

15 SP. OFF

Lights up when headphone is inserted or the SPEAKERS button is set to OFF.

16

Lights up when Dolby Digital signals are input.

Customizing Sound Fields

By adjusting the surround parameters and the equalization of the front, center, surround and surround back speakers, you can customize the sound fields to suit your particular listening situation.

Once you customize a sound field, the changes are stored in the memory indefinitely. You can change a customized sound field any time by making new adjustments to the parameters.

See the table on pages 37–41 for the parameters available in each sound field.

To get the most from multi channel surround sound

Position your speakers and do the procedures described in “Multi Channel Surround Setup” starting from page 17 before you customize a sound field.

Adjusting the surround parameters

The SURR menu contains parameters that let you customize various aspects of the current sound field. The settings available in this menu are stored individually for each sound field.

- 1 Start playing a program source encoded with multi channel surround sound.
- 2 Press SURR.
The button lights up and the first parameter is displayed.
- 3 Press the cursor buttons (< or >) to select the parameter you want to adjust.
- 4 Turn the jog dial to select the setting you want.
The setting is stored automatically.

Pro Logic (PRO LOGIC)

Initial setting : AUTO

Lets you specify the Pro Logic decoding setting.

- When set to “AUTO”, the receiver performs PRO LOGIC decoding if Dolby surround encoded flag is ON or if Pro Logic decoding produces a better sound field.
- When set to “ON”, the receiver performs PRO LOGIC decoding on surround signals, regardless of the Dolby surround encoded flag.
- When set to “OFF”, the receiver does not perform PRO LOGIC decoding.

Note

Pro Logic decoding does not function for MPEG format signals.

Effect level (EFFECT)

Initial setting : (depends on sound mode)

Lets you adjust the “presence” of the current surround effect.

Wall type (WALL S_I_H)

Initial setting : Midpoint

Lets you control the level of the high frequencies to alter the sonic character of your listening environment by simulating a softer (S) or harder (H) wall. The midpoint designates a neutral wall (made of wood).

Reverberation (REVB S_I_L)

Initial setting : Midpoint

Lets you control the spacing of the early reflections to simulate a sonically larger (L) or smaller (S) room. The midpoint designates a standard room with no adjustment.

Front reverberation (FRONT REVERB)

Initial setting : STD

This parameter can be used when “DIGITAL CONCERT HALL A, B” is selected. This parameter lets you adjust the amount of reverberations to add to the front signals according to the original reverberations in the source.

- To increase front reverberations, select “WET”.
- To decrease front reverberations, select “DRY”.

Screen depth (SCEEN DEPTH)

Initial setting : MID

In a movie theater, sound seems to come from inside the image reflected on the movie screen. This parameter allows you to create the same sensation in your listening room by shifting the sound of the front speakers “into” the screen. “DEEP” provides the greatest amount of screen depth.

Virtual speaker (VIR. SPEAKERS)

Initial setting : ON

Allows you turn the virtual speakers created by the CINEMA STUDIO EX A, B, C and SEMI CINEMA STUDIO EX A, B, C sound fields off or on.

Adjusting the level parameters

The LEVEL menu contains parameters that let you adjust the balance and speaker volumes of each speaker. The settings available in this menu are applied to all sound fields.

- 1 Start playing a program source encoded with multi channel surround sound.
- 2 Press LEVEL.
The button lights up and the first parameter is displayed.
- 3 Press the cursor buttons (< or >) to select the parameter you want to adjust.
- 4 Turn the jog dial to select the setting you want.
The setting is stored automatically.

Front balance (FRONT L_I_R)

Initial setting : Center

Lets you adjust the balance between the front left and right speakers.

Surround balance (SURROUND L_I_R)

Initial setting : Center

Lets you adjust the balance between the surround left and right speakers.

Center level (CENTER LEVEL XXX dB)

Initial setting : 0 dB

Lets you adjust the level of the center speaker.

Surround level (SURROUND LEVEL XXX dB)

Initial setting : 0 dB

Lets you adjust level of the surround (left and right) speakers.

Surround back level (SURR BACK LEVEL XXX dB)

Initial setting : 0 dB

Lets you adjust the level of the surround back speaker.

Sub woofer level (S. WOOFER LEVEL XXX dB)

Initial setting : 0 dB

Lets you adjust the level of the sub woofer.

Low Frequency Effect (LFE MIX XXX dB)

Initial setting : 0 dB

Lets you attenuate the level of the LFE (Low Frequency Effect) channel output from the sub woofer without affecting the level of the bass frequencies sent to the sub woofer from the front, center or surround channels via the Dolby Digital or DTS bass redirection circuitry.

- For LFE mix level, "0 dB" outputs the full LFE signal at the mix level determined by the recording engineer.
- To mute the sound of the LFE channel from the sub woofer, select "OFF". However, the low frequency sounds of the front, center, or surround speakers are output from the sub woofer according to the settings made for each speaker in the speaker setup (page 17-21).

Dynamic range compressor (D. RANGE COMP.)

Initial setting : OFF

Lets you compress the dynamic range of the sound track. This may be useful when you want to watch movies at low volumes late at night. We recommend using the "MAX" setting.

- To reproduce the sound track with no compression, select "OFF".
- To reproduce the sound track with the dynamic range intended by the recording engineer, select "STD".
- To compress the dynamic range in small steps to achieve the sound you desire, select "0.1" - "0.9".
- To reproduce a dramatic compression of the dynamic range, select "MAX".

Note

Dynamic range compression is possible with Dolby Digital sources only.

Adjusting the equalizer

The EQ menu lets you adjust the equalization of the front, center, surround, and surround back speakers. The settings are stored individually for each sound field.

- 1 Start playing a program source encoded with multi channel surround sound.
- 2 Press EQ.
The button lights up and the first parameter is displayed.
- 3 Press the cursor buttons (< or >) to select the parameter (gain (dB), bandwidth, frequency (Hz)) you want to adjust.
- 4 Turn the jog dial to select the setting you want.
The setting is entered automatically.

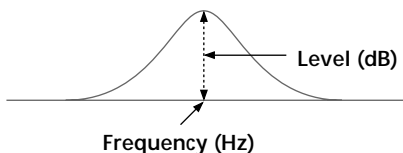

To turn on/ off the equalizer

Press EQUALIZER. The EQ indicator in the display lights up when the equalizer is turned on. When you adjust the equalizer using the EQ parameters, the settings are stored separately for each sound field and can be reproduced whenever you turn on the equalizer.

Front speaker bass adjustment (Level/ Frequency)

Lets you adjust the gain and frequency of bass.

Front speaker midrange adjustment (Level/ Frequency)

Lets you adjust the gain and frequency of midrange.

Front speaker treble adjustment (Level/ Frequency)

Lets you adjust the gain and frequency of treble.

Center speaker bass adjustment (Level/ Frequency)

Lets you adjust the gain and frequency of bass.

Center speaker midrange adjustment (Level/ Frequency)

Lets you adjust the gain and frequency of midrange.

Center speaker treble adjustment (Level/ Frequency)

Lets you adjust the gain and frequency of treble.

Surround speaker bass adjustment (Level/ Frequency)

Lets you adjust the gain and frequency of bass.

Surround speaker treble adjustment (Level/ Frequency)

Lets you adjust the gain and frequency of treble.

Surround back speaker bass adjustment (Level/ Frequency)

Lets you adjust the gain and frequency of bass.

Surround back speaker treble adjustment (Level/ Frequency)

Lets you adjust the gain and frequency of treble.

Resetting customized sound fields to the factory settings

- 1 If the power is on, press I/⏻ to turn off the power.
- 2 Hold down SOUND FIELD MODE and press I/⏻.
“S. F Initialize” appears in the display and all sound fields are reset at once.

Customizing Sound Fields

Adjustable parameters for each sound field

The adjusted SURR and EQ parameters are stored in each sound field. The adjusted LEVEL parameters are applied to all the sound fields.

	SURR						
	PRO LOGIC	EFFECT LEVEL	WALL TYPE	REVERB TIME	FRONT REVERB	SCREEN DEPTH	VIRTUAL SPEAKERS
2CH							
A.F.D.	AUTO						
NORMAL SURROUND	●						
CINEMA STUDIO EX A	●	●				●	●
CINEMA STUDIO EX B	●	●				●	●
CINEMA STUDIO EX C	●	●				●	●
SEMI CINEMA STUDIO EX A	●	●				●	●
SEMI CINEMA STUDIO EX B	●	●				●	●
SEMI CINEMA STUDIO EX C	●	●				●	●
NIGHT THEATER	●	●	●	●			
MONO MOVIE	●	●	●	●			
STEREO MOVIE	●	●	●	●			
V. MULTI DIMENSION	●						
VIRTUAL MULTI REAR	●						
V. SEMI M. DIMENSION	●						
VIRTUAL ENHANCED A	●						
VIRTUAL ENHANCED B	●						
DIGITAL CONCERT HALL A	●	●			●		
DIGITAL CONCERT HALL B	●	●			●		
CHURCH	●	●	●	●			
OPERA HOUSE	●	●	●	●			
JAZZ CLUB	●	●	●	●			
DISCO/CLUB	●	●	●	●			
LIVE HOUSE	●	●	●	●			
ARENA	●	●	●	●			
STADIUM	●	●	●	●			
GAME	●	●	●	●			
HEADPHONE (2CH)							
HEADPHONE (DIRECT)							
HEADPHONE THEATER	●	●					
MULTI CH IN							
2CH ANALOG DIRECT							
PCM96K							

Customizing Sound Fields

Adjustable parameters for each sound field (continued)

	LEVEL								
	<	FRONT BAL	SURR BAL	CENTER LEVEL	SURR LEVEL	SURR BACK LEVEL	SUB WOOFER LEVEL	LFE MIX ¹⁾	>
2CH		●						●	●
A.F.D.		●	●	●	●	●	●	●	●
NORMAL SURROUND		●	●	●	●	●	●	●	●
CINEMA STUDIO EX A		●	●	●	●	●	●	●	●
CINEMA STUDIO EX B		●	●	●	●	●	●	●	●
CINEMA STUDIO EX C		●	●	●	●	●	●	●	●
SEMI CINEMA STUDIO EX A		●		●			●	●	●
SEMI CINEMA STUDIO EX B		●		●			●	●	●
SEMI CINEMA STUDIO EX C		●		●			●	●	●
NIGHT THEATER		●	●	●	●	●	●	●	●
MONO MOVIE		●	●	●	●	●	●	●	●
STEREO MOVIE		●	●	●	●	●	●	●	●
V. MULTI DIMENSION		●	●	●	●	●	●	●	●
VIRTUAL MULTI REAR		●	●	●	●	●	●	●	●
V. SEMI M. DIMENSION		●		●			●	●	●
VIRTUAL ENHANCED A		●		●			●	●	●
VIRTUAL ENHANCED B		●		●			●	●	●
DIGITAL CONCERT HALL A		●	●	●	●	●	● ²⁾	●	●
DIGITAL CONCERT HALL B		●	●	●	●	●	● ²⁾	●	●
CHURCH		●	●	●	●	●	● ²⁾	●	●
OPERA HOUSE		●	●	●	●	●	● ²⁾	●	●
JAZZ CLUB		●	●	●	●	●	● ²⁾	●	●
DISCO/CLUB		●	●	●	●	●	●	●	●
LIVE HOUSE		●	●	●	●	●	● ²⁾	●	●
ARENA		●	●	●	●	●	● ²⁾	●	●
STADIUM		●	●	●	●	●	● ²⁾	●	●
GAME		●	●	●	●	●	●	●	●
HEADPHONE (2CH)		●							●
HEADPHONE (DIRECT)		●							
HEADPHONE THEATER		●							●
MULTI CH IN		●	●	●	●		●		
2CH ANALOG DIRECT		●							
PCM96K		●							

¹⁾ These parameters may not operate depending on the source or adjustments. For details, see each item in "Adjusting the level parameters" (page 35).

²⁾ When these sound fields are selected, there is no sound output from the SUB WOOFER terminal if your front speaker size is set to "LARGE". However, sound will be output from the sub woofer if the digital input signal contains L.F.E. signals..

Adjustable parameters for each sound field (continued)

	EQ					
	< BASS GAIN	BASS FREQ	FRONT MID GAIN	MID FREQ	TREBLE GAIN	> TREBLE FREQ
2CH	●	●	●	●	●	●
A.F.D.	●	●	●	●	●	●
NORMAL SURROUND	●	●	●	●	●	●
CINEMA STUDIO EX A	●	●	●	●	●	●
CINEMA STUDIO EX B	●	●	●	●	●	●
CINEMA STUDIO EX C	●	●	●	●	●	●
SEMI CINEMA STUDIO EX A	●	●	●	●	●	●
SEMI CINEMA STUDIO EX B	●	●	●	●	●	●
SEMI CINEMA STUDIO EX C	●	●	●	●	●	●
NIGHT THEATER	●	●	●	●	●	●
MONO MOVIE	●	●	●	●	●	●
STEREO MOVIE	●	●	●	●	●	●
V. MULTI DIMENSION	●	●	●	●	●	●
VIRTUAL MULTI REAR	●	●	●	●	●	●
V. SEMI M. DIMENSION	●	●	●	●	●	●
VIRTUAL ENHANCED A	●	●	●	●	●	●
VIRTUAL ENHANCED B	●	●	●	●	●	●
DIGITAL CONCERT HALL A	●	●	●	●	●	●
DIGITAL CONCERT HALL B	●	●	●	●	●	●
CHURCH	●	●	●	●	●	●
OPERA HOUSE	●	●	●	●	●	●
JAZZ CLUB	●	●	●	●	●	●
DISCO/CLUB	●	●	●	●	●	●
LIVE HOUSE	●	●	●	●	●	●
ARENA	●	●	●	●	●	●
STADIUM	●	●	●	●	●	●
GAME	●	●	●	●	●	●
HEADPHONE (2CH)	●	●	●	●	●	●
HEADPHONE (DIRECT)						
HEADPHONE THEATER	●	●	●	●	●	●
MULTI CH IN						
2CH ANALOG DIRECT						
PCM96K						

Customizing Sound Fields

Adjustable parameters for each sound field (continued)

	EQ					
	<					>
	< BASS GAIN	BASS FREQ	CENTER MID GAIN	MID FREQ	TREBLE GAIN	TREBLE FREQ >
2CH						
A.F.D.	●	●	●	●	●	●
NORMAL SURROUND	●	●	●	●	●	●
CINEMA STUDIO EX A	●	●	●	●	●	●
CINEMA STUDIO EX B	●	●	●	●	●	●
CINEMA STUDIO EX C	●	●	●	●	●	●
SEMI CINEMA STUDIO EX A	●	●	●	●	●	●
SEMI CINEMA STUDIO EX B	●	●	●	●	●	●
SEMI CINEMA STUDIO EX C	●	●	●	●	●	●
NIGHT THEATER	●	●	●	●	●	●
MONO MOVIE	●	●	●	●	●	●
STEREO MOVIE	●	●	●	●	●	●
V. MULTI DIMENSION	●	●	●	●	●	●
VIRTUAL MULTI REAR	●	●	●	●	●	●
V. SEMI M. DIMENSION	●	●	●	●	●	●
VIRTUAL ENHANCED A	●	●	●	●	●	●
VIRTUAL ENHANCED B	●	●	●	●	●	●
DIGITAL CONCERT HALL A	●	●	●	●	●	●
DIGITAL CONCERT HALL B	●	●	●	●	●	●
CHURCH	●	●	●	●	●	●
OPERA HOUSE	●	●	●	●	●	●
JAZZ CLUB	●	●	●	●	●	●
DISCO/CLUB	●	●	●	●	●	●
LIVE HOUSE	●	●	●	●	●	●
ARENA	●	●	●	●	●	●
STADIUM	●	●	●	●	●	●
GAME	●	●	●	●	●	●
HEADPHONE (2CH)						
HEADPHONE (DIRECT)						
HEADPHONE THEATER						
MULTI CH IN						
2CH ANALOG DIRECT						
PCM96K						

Adjustable parameters for each sound field (continued)

	EQ			
	<			>
	< BASS GAIN	SURROUND/SURROUND BACK BASS FREQ	TREBLE GAIN	> TREBLE FREQ
2CH				
A.F.D.	●	●	●	●
NORMAL SURROUND	●	●	●	●
CINEMA STUDIO EX A	●	●	●	●
CINEMA STUDIO EX B	●	●	●	●
CINEMA STUDIO EX C	●	●	●	●
SEMI CINEMA STUDIO EX A				
SEMI CINEMA STUDIO EX B				
SEMI CINEMA STUDIO EX C				
NIGHT THEATER	●	●	●	●
MONO MOVIE	●	●	●	●
STEREO MOVIE	●	●	●	●
V. MULTI DIMENSION	●	●	●	●
VIRTUAL MULTI REAR	●	●	●	●
V. SEMI M. DIMENSION				
VIRTUAL ENHANCED A				
VIRTUAL ENHANCED B				
DIGITAL CONCERT HALL A	●	●	●	●
DIGITAL CONCERT HALL B	●	●	●	●
CHURCH	●	●	●	●
OPERA HOUSE	●	●	●	●
JAZZ CLUB	●	●	●	●
DISCO/CLUB	●	●	●	●
LIVE HOUSE	●	●	●	●
ARENA	●	●	●	●
STADIUM	●	●	●	●
GAME	●	●	●	●
HEADPHONE (2CH)				
HEADPHONE (DIRECT)				
HEADPHONE THEATER				
MULTI CH IN				
2CH ANALOG DIRECT				
PCM96K				

Receiving Broadcasts

This chapter describes how to receive FM or AM broadcasts and how to preset selected stations.

You can tune in stations on this receiver in the following ways:

Automatic FM Memory (AUTOBETICAL)

You can have the receiver automatically store up to 30 of the clearest FM and FM RDS stations in alphabetical order (see page 44).

Direct Tuning

You can enter a frequency of the station you want directly by using the numeric buttons on the supplied remote (see page 44).

Automatic Tuning

If you don't know the frequency of the station you want, you can let the receiver scan all available stations in your area (see page 45).

Preset Tuning

After you have tuned in stations using Direct Tuning or Automatic Tuning, you can preset them to the receiver (see page 45). Then you can tune in any of the stations directly by entering its 2-character code using the supplied remote (see page 45). Up to 30 FM or AM stations can be preset. The receiver will also scan all the stations that you have preset (see page 46).

RDS functions

Radio Data System (RDS) is a broadcasting service that allows radio stations to send additional information along with the regular radio programme signal. This receiver offers you two convenient RDS features:

- Displaying the RDS information (see page 46)
- Locating a station by programme type (see page 47)

Note that RDS is operable only for FM stations.*

** Not all FM stations provide RDS service, nor do they provide the same types of services. If you are not familiar with the RDS services in your area, check with your local radio stations for details.*

Before you begin, make sure you have:

- Connected FM and AM antennas to the receiver (see page 5).

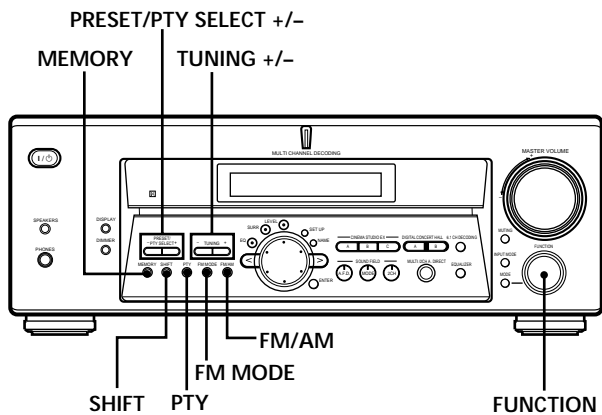

Brief descriptions of buttons used to receive broadcasts

DISPLAY button: Press to display the RDS information.

MEMORY button: Uses for memorizing preset stations.

PRESET/PTY SELECT +/- buttons: Press to scan all preset radio stations or select program types.

TUNING +/- buttons: Press to scan all available radio stations.

FUNCTION control: Rotate to select the tuner or other source.

PTY button: Press to scan preset stations by the program type.

FM MODE button: If "STEREO" flashes in the display and the FM stereo reception is poor, press this button to improve the sound. You will not be able to enjoy stereo effect but the sound will be less distorted.

Note
If "STEREO" does not appear at all even when the FM broadcast is received normally, press this button to turn on the "STEREO" indication.

FM/AM button: Press to select the FM or AM band.

SHIFT button: Press to select a memory page (A, B, or C) for presetting radio stations or tuning to preset stations.

On the remote:
D. TUNING: Press this button to enter a frequency directly using the numeric buttons.

Numeric buttons: Press to enter a numeric value when inputting the frequency directly, presetting radio stations, or tuning to preset stations.

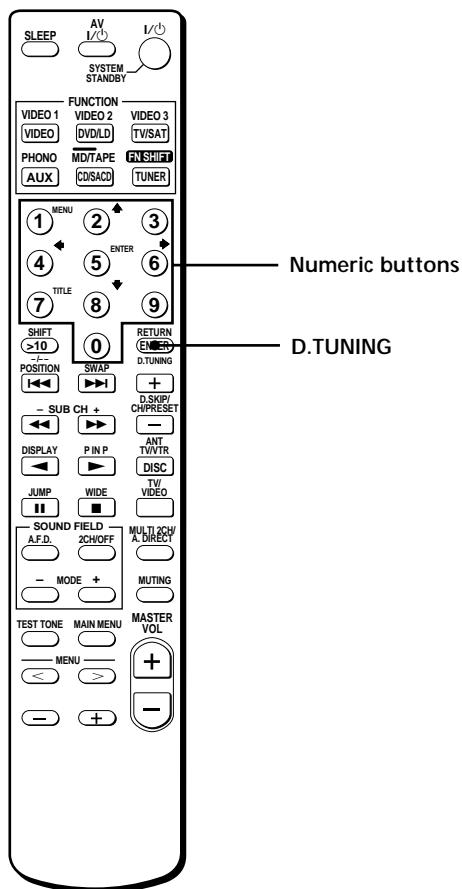

Storing FM Stations Automatically in Alphabetical Order (“Autobetical”)

This function lets you store up to 30 FM and FM RDS stations in alphabetical order without redundancy. Additionally, it only stores the stations with the clearest signals.

If you want to store FM or AM stations one by one, see “Presetting radio stations” on page 45.

For details on the buttons used in this section, see “Brief descriptions of buttons used to receive broadcasts” on page 43.

- 1 Press **I/⏻** to turn off the receiver.
- 2 Hold down **MEMORY** and press **I/⏻** to turn the receiver back on.
“Autobetical select” appears in the display and the receiver scans and stores all the FM and FM RDS stations in the broadcast area.
For RDS stations, the tuner first checks for stations broadcasting the same program, then stores only the one with the clearest signal. The selected RDS stations are sorted alphabetically by their Program Service name, then assigned a two character preset code. For more details on RDS see page 46.
Regular FM stations are assigned two character preset codes and stored after the RDS station.
When done, “Autobetical finish” appears in the display momentarily and the receiver returns to normal operation.

Notes

- Do not press any of the buttons on the receiver or supplied remote during autobetical operation.
- If you move to another area, repeat this procedure to store stations in your new area.
- For details on tuning the stored stations, see page 46.
- The FM MODE setting is also stored along with the station.
- If you move the antenna after storing stations with this procedure, the stored settings may no longer be valid. If this happens, repeat this procedure to store the stations again.

Direct Tuning

For details on the buttons used in this section, see “Brief descriptions of buttons used to receive broadcasts” on page 43.

- 1 Rotate **FUNCTION** to select the tuner.
The last received station is tuned in.
- 2 Press **FM/AM** to select the FM or AM band.
- 3 Press **D. TUNING** on the remote.
- 4 Press the numeric buttons on the remote to enter the frequency.

Example 1: FM 102.50 MHz

① → ② → ③ → ④ → ⑤

Example 2: AM 1350 kHz

(You don't have to enter the last “0” when the tuning scale is set to 10 kHz.)

① → ③ → ⑤ → ⑥

If you cannot tune in a station and the entered numbers flash

Make sure you've entered the right frequency. If not, repeat Steps 3 and 4.

If the entered numbers still flash, the frequency is not used in your area.

- 5 If you've tuned in an AM station, adjust the direction of the AM loop antenna for optimum reception.
- 6 Repeat Steps 2 to 5 to receive another station.

 If you try to enter a frequency not covered by the tuning interval

The entered value is automatically rounded up or down.

Tuning interval is:

FM : 50 kHz

AM : 9 kHz

Automatic Tuning

For details on the buttons used in this section, see “Brief descriptions of buttons used to receive broadcasts” on page 43.

- 1 Rotate **FUNCTION** to select the tuner.
The last received station is tuned in.
- 2 Press **FM/AM** to select the FM or AM band.
- 3 Press **TUNING +** or **TUNING -**.
Press the + button to scan from low to high; press the - button to scan from high to low.
The receiver stops scanning whenever a station is received.

When the receiver reaches either end of the band

Scanning is repeated in the same direction.

- 4 To continue scanning, press **TUNING +** or **TUNING -** again.

Preset Tuning

For details on the buttons used in this section, see “Brief descriptions of buttons used to receive broadcasts” on page 43.

Before tuning to preset stations, be sure to preset them by performing steps on “Presetting radio stations” below.

Presetting radio stations

- 1 Rotate **FUNCTION** to select the tuner.
The last received station is tuned in.
- 2 Tune in the station that you want to preset using **Direct Tuning** (page 44) or **Automatic Tuning** (this page).
- 3 Press **MEMORY**.
“MEMORY” appears in the display for a few seconds.
Do Steps 4 to 6 before “MEMORY” goes out.
- 4 Press **SHIFT** to select a memory page (A, B or C).
Each time you press **SHIFT**, the letter “A,” “B” or “C” appears in the display.
- 5 Press **PRESET/PTY SELECT +** or **PRESET/PTY SELECT -** to select a preset number.
If “MEMORY” goes out before you press the preset number, start again from Step 3.
- 6 Press **MEMORY** again to store the station.
If “MEMORY” goes out before you can store the station, start again from Step 3.
- 7 Repeat Steps 2 to 6 to preset another station.

To change a preset number to another station

Do Steps 1 to 6 to preset the new station to the number.

Preset Tuning

Tuning to preset stations

You can tune the preset stations either of the following two ways.

Scanning the preset stations

- 1 Rotate **FUNCTION** to select the tuner.
The last received station is tuned in.
- 2 Press **PRESET/PTY SELECT +** or **PRESET/PTY SELECT -** repeatedly to select the preset station you want. Each time you press the button, the receiver tunes in one preset station at a time, in the corresponding order and direction as follows:

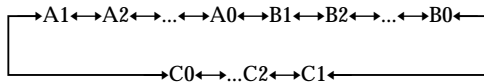

You can scan the preset stations by program type. See page 47.

Using the preset codes

- 1 Rotate **FUNCTION** to select the tuner.
The last received station is tuned in.
- 2 Press **SHIFT** to select a memory page (A, B, or C), then press the preset number of the station you want using the numeric buttons on the supplied remote.

Using the Radio Data System (RDS)

Receiving RDS broadcasts

Simply select a station on the FM band using direct tuning (page 44), automatic tuning or preset tuning (page 45).

When you tune in a station that provides RDS services, the RDS indicator lights up and the program station name appears in the display.

Note

RDS may not work properly if the station you tuned to is not transmitting the RDS signal properly or if the signal strength is weak.

Displaying RDS information

While receiving an RDS station, press **DISPLAY** repeatedly to change the RDS information on the display window as follows:

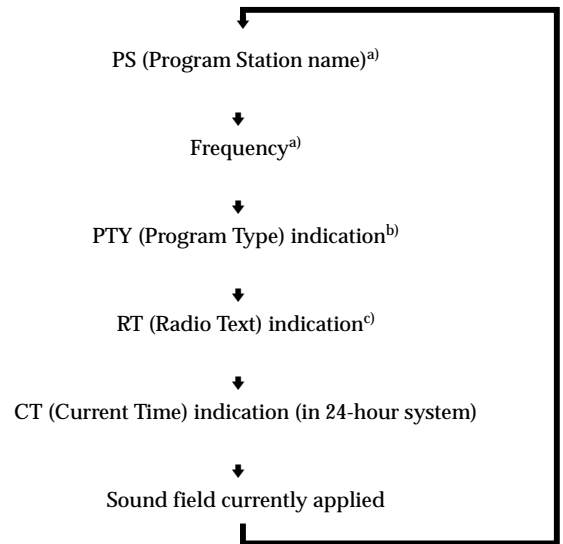

a) This information also appears for non-RDS FM stations.

b) Type of program being broadcast. (See page 47.)

c) Text messages sent by the RDS station

Notes

- If there is an emergency announcement by government authorities, "Alarm-Alarm!" flashes in the display.
- If a station does not provide a particular RDS service, "No XX" (such as "No Clock Time") appears in the display.
- When a station broadcasts radio text data, it is displayed at the same rate at which it is sent from the station. Any change in this rate is reflected in the display rate of the data.

Scanning preset stations by program type

You can tune in preset stations according to a program type that you specify. The receiver scans for stations in its preset memory currently broadcasting the specified program type.

- 1 Press **PTY**.
- 2 Press **PRESET/PTY SELECT +** or **PRESET/PTY SELECT -** to select the program type.
See the table on the next page for information on each program type.
- 3 Press **PTY**.
While the receiver is scanning stations, “**PTY SEARCH**” and the program type indication appear alternately in the display window.
When the receiver finds a station, the receiver stops scanning.
When the receiver could not find any preset stations currently broadcasting the specified program type, “**PTY not found**” appears in the display.

Description of program types

Program type indication	Description
News	News programs
Current Affairs	Topical programs that expand on current news
Information	Programs offering information on a wide spectrum of subjects, including consumer affairs and medical advice
Sport	Sports programs
Education	Educational programs, such as “how-to” and advice programs
Drama	Radio plays and serials
Cultures	Programs about national or regional culture, such as language and social concerns
Science	Programs about the natural sciences and technology
Varied Speech	Other types of programs such as celebrity interviews, panel games, and comedy
Pop Music	Popular music programs
Rock Music	Rock music programs
M.o.R. Music	Easy Listening

Program type indication	Description
Light Classics M	Instrumental, vocal, and choral music
Serious Classics	Performances of major orchestras, chamber music, opera, etc.
Other Music	Music that does not fit into any categories above, such as Rhythm & Blues and Reggae
Weather & Metr	Weather information
Finance	Stock market reports and trading, etc.
Children’s Progs	Programs for children
Social Affairs	Programs about people and the things that affect them
Religion	Programs of religious content
Phone In	Programs where members of the public express their views by phone or in a public forum
Travel & Touring	Programs about travel. Not for announcements that are located by TP/TA.
Leisure & Hobby	Programs on recreational activities such as gardening, fishing, cooking, etc.
Jazz Music	Jazz programs
Country Music	Country music programs
National Music	Programs featuring the popular music of the country or region
Oldies Music	Programs featuring oldies music
Folk Music	Folk music programs
Documentary	Investigative features
None	Any programs not defined above

Other Operations

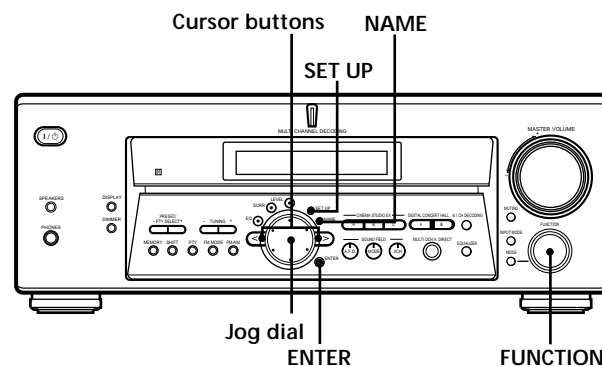

Brief descriptions of buttons that appear in this chapter

NAME button: Press to name preset stations or program sources.

Jog dial: Use to select characters when naming preset stations or program sources.

Cursor buttons (</>): Use to move the cursor when naming preset stations or program sources.

FUNCTION control: Rotate to select the tuner or other source.

SET UP button: Press to enter the set up mode.

ENTER button: Press to enter the completed name of the preset station or program source.

Naming Preset Stations and Program Sources

You can enter a name (index name) of up to 8 characters for preset stations and program sources. These names (for example, "VHS") appear in the receiver's display when a station or program source is selected.

Note that no more than one name can be entered for each preset station or program source.

This function is useful for distinguishing components of the same kind. For example, two VCRs can be specified as "VHS" and "8mm," respectively. It is also handy for identifying components connected to jacks meant for another type of component, for example, a second CD player connected to the MD/TAPE jacks.

1 To name a preset station

Rotate **FUNCTION** to select the tuner.
The last station you received is tuned in.

To name a program source

Select the program source (component) to be named, then go to Step 3.

2 Tune in the preset station you want to create an index name for.

If you are not familiar with how to tune in preset stations, see "Tuning to preset stations" on page 46.

3 Press **NAME**.

4 Create an index name by using the jog dial and cursor buttons:

Turn the jog dial to select a character, then press **>** to move the cursor to the next position.

To insert a space

Turn the jog dial until a blank space appears in the display.

If you've made a mistake

Press **<** or **>** repeatedly until the character to be changed flashes, then turn the jog dial to select the right character.

5 Press **ENTER**.

To assign index names to other stations

Repeat Steps 2 to 5.

Recording

Your receiver makes it easy to record to and from the components connected to it. You don't have to connect the playback and recording components directly to each other: once you select a program source on the receiver, you can record and edit as you normally would using the controls on each component.

Before you begin, make sure you've connected all components properly.

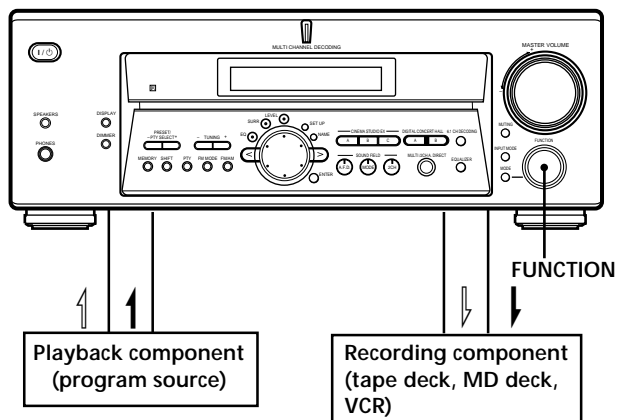

⚡: Audio signal flow

→: Video signal flow

Recording on an audio tape or MiniDisc

You can record on a cassette tape or MiniDisc using the receiver. See the instruction manual of your cassette deck or MD deck if you need help.

1 Select the component to be recorded.

2 Prepare the component for playing.

For example, insert a CD into the CD player.

3 Insert a blank tape or MD into the recording deck and adjust the recording level, if necessary.

4 Start recording on the recording deck, then start playback on the playback component.

Recording on a video tape

You can record from a VCR, a TV, or an LD player using the receiver. You can also add audio from a variety of audio sources when editing a video tape. See your VCR or LD player's instruction manual if you need help.

- 1 Select the program source to be recorded.
- 2 Prepare the component for playing.
For example, insert the laser disc you want to record into the LD player.
- 3 Insert a blank video tape into the VCR (VIDEO 1 or VIDEO 2) for recording.
- 4 Start recording on the recording VCR, then start playing the video tape or laser disc you want to record.

 You can record the sound from any audio source onto a video tape while copying from a video tape or laser disc. Locate the point where you want to start recording from another audio source, select the program source, then start playback. The audio from that source will be recorded onto the audio track of the video tape instead of the audio from the original medium.

To resume audio recording from the original medium, select the video source again.

Notes

- Please be sure to make both digital and analog connections to the TV/SAT and DVD/LD inputs. Analog recording is not possible if you only make digital connections.
- Some sources contain copy guards to prevent recording. In this case, you may not be able to record from the sources.
- You cannot record a digital audio signal using a component connected to the analog MD/TAPE OUT jacks. To record a digital audio signal, connect a digital component to the DIGITAL MD/TAPE OUT jacks.
- Sound adjustments do not affect the signal output from the MD/TAPE OUT jacks.
- When MULTI/2CH A. DIRECT is set to MULTI DIRECT, audio signals are not output from REC OUT jacks.
- No signals output from DIGITAL OUT jacks (MD/TAPE OPTICAL OUT) when you set MULTI/2CH A. DIRECT to 2CH A. DIRECT.

Using the Sleep Timer

You can set the receiver to turn off automatically at a specified time.

Press SLEEP on the remote while the power is on. Each time you press SLEEP, the time changes as shown below.

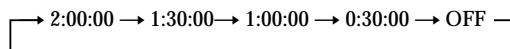

The display dims after you have specified the time. While using Sleep Timer, "SLEEP" lights up in the display.

Tips

- You can freely specify the time. After pressing SLEEP, specify the time you want using the jog dial and cursor buttons (< or >) on the receiver. The sleep time changes in 1 second intervals. You can specify up to 5 hours.
- To check the remaining time before the receiver turns off, press SLEEP. The remaining time appears in the display.

Adjustments Using the SET UP Button

The SET UP button allows you to make the following adjustments other than specifying the speaker parameters.

6.1 CH DECODING

This parameter lets you enjoy the appropriate surround sound from the surround channels. The default setting is "AUTO".

- 1 Press SET UP.
- 2 Press the cursor buttons (< or >) to select "6.1 CH DECODING".
- 3 Turn the jog dial to select "AUTO", "ON" or "OFF".

Notes

- You can set this parameter using 6.1 CH DECODING on the front panel.
- When set to "AUTO", the receiver performs 6.1 channel matrix decoding only if 6.1 channel signals decode flag is ON.
- When set to "ON", the receiver performs 6.1 channel matrix decoding only if the surround signals are 2 channel, regardless of the 6.1 channel decode flag.
- When set to "OFF", the receiver does not perform 6.1 channel matrix decoding.
- During "A.F.D." this parameter is always set to "AUTO", and you cannot change the setting.
- When the 6.1 channel matrix decoding is performed and the surround back speaker is set to "NO", you can enjoy the surround back signals with Virtual 3D technology, even without an actual surround back speaker (the box around SB does not light up). If the surround back speaker is set to "YES", the surround back signals are output through the actual speaker (SB lights up). Please note that you can set the surround back speaker only when the center speaker is set to "NO" (page 18).

Multi channel assignment

Lets you assign a function to MULTI CH. You cannot assign TUNER or PHONO.

- 1 Press SET UP.
- 2 Press the cursor buttons (< or >) to select "MULTI CH".
- 3 Turn the jog dial to select "NONE", "VIDEO 1", "VIDEO 2", "DVD/LD", "TV/SAT", "MD/TAPE" and "CD/SACD".

Sound Field Link

When set to "ON", the sound field that was last applied to a program source is automatically applied whenever it is selected. For example, if you listen to CD with STADIUM as the sound field, change to a different program source, then return to CD, STADIUM will be applied again. If you do not want to use this function, set to "OFF". The default setting is "ON".

- 1 Press SET UP.
- 2 Press the cursor buttons (< or >) to select "S. FIELD LINK".
- 3 Turn the jog dial to select "ON" or "OFF".

Adjusting the CONTROL A1 II auto power on

Lets you turn on the receiver automatically when the component connected via CONTROL A1 cords (see page 12) is turned on and the playback is started. When set to "OFF", you can save the power consumption of the receiver during standby mode. The default setting is "ON".

- 1 Press SET UP.
- 2 Press the cursor buttons (< or >) to select "AI AUTO POWER".
- 3 Turn the jog dial to select "ON" or "OFF".

Adjusting the CONTROL A1 II auto function

Lets you switch the function of this receiver to the Sony components connected via CONTROL A1 cords (see page 12) automatically when the connected component is set to play mode. The default setting is "ON".

- 1 Press SET UP.
- 2 Press the cursor buttons (< or >) to select "AUTO FUNCTION".
- 3 Turn the jog dial to select "ON" or "OFF".

CONTROL A1II Control System

Getting Started

This section explains the basic functions of the CONTROL A1II Control System. Certain components have special functions, like "CD Synchro Dubbing" on cassette decks, that require CONTROL A1II connections. For detailed information regarding specific operations, be sure to also refer to the Operating Instructions supplied with your component(s).

The CONTROL A1II Control System was designed to simplify the operation of audio systems composed of separate Sony components. CONTROL A1II connections provide a path for the transmission of control signals which enable automatic operation and control features usually associated with integrated systems. Currently, CONTROL A1II connections between a Sony CD player, amplifier (receiver), MD deck and cassette deck provide automatic function selection and synchronized recording.

In the future the CONTROL A1II connection will work as a multifunction bus allowing you to control various functions for each component.

Notes

- The CONTROL A1II Control System is designed to maintain upward compatibility as the Control System is upgraded to handle new functions. In this case, however, older components will not be compatible with the new functions.
- Do not operate a 2 way remote control unit when the CONTROL A1II jacks are connected via a PC interface kit to a personal computer running "MD Editor" or similar application. Also, do not operate the connected component in a manner contrary to the functions of the application, as this may cause the application to operate incorrectly.

CONTROL A1II and CONTROL A1 compatibility

The CONTROL A1 control system has been updated to the CONTROL A1II which is the standard system in the SONY 300 disc CD changer and other recent Sony components. Components with CONTROL A1 jacks are compatible with components with CONTROL A1II, and can be connected to each other. Basically, the majority of the functions available with the CONTROL A1 control system will be available with the CONTROL A1II control system.

However, when making connections between components with CONTROL A1 jacks and components with CONTROL A1II jacks, the number of functions that can be controlled may be limited depending on the component. For detailed information, refer to the Operating Instructions supplied with the component(s).

Connections

Connect monaural (2P) mini-plug cords in series to the CONTROL A1II jacks on the back of each component. You can connect up to ten CONTROL A1II compatible components in any order. However, you can connect only one of each type of component (i.e., 1 CD player, 1 MD deck, 1 tape deck and 1 receiver). (You may be able to connect more than one CD player or MD deck, depending on the model. Refer to the operating instructions supplied with the respective component for details.)

Example

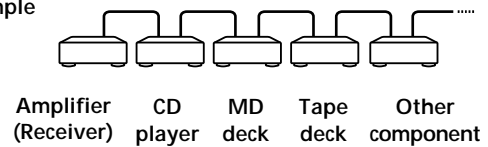

In the CONTROL A1II control system, the control signals flow both ways, so there is no distinction of IN and OUT jacks. If a component has more than one CONTROL A1II jack, you can use either one, or connect different components to each jack.

Jacks and connection examples

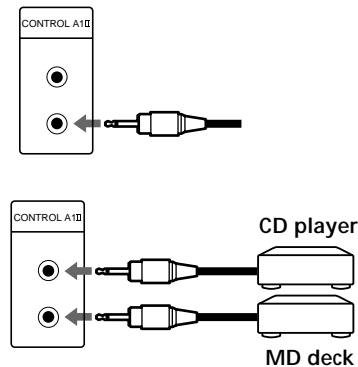

On CONTROL A1 jacks and connections

It is possible to make connections between CONTROL A1 and CONTROL A1II jacks. For details regarding particular connections or setup options, refer to the Operating Instructions supplied with the component(s).

About the connecting cord

Some CONTROL A1 compatible components are supplied with a connecting cord as an accessory. In this case, use the connecting cord for your connection.

When using a commercially available cord, use a monaural (2P) mini-plug cord less than 2 meters long, with no resistance (like the Sony RK-G69HG).

Basic Functions

The CONTROL A1II functions will operate as long as the component you want to operate is turned on, even if all of the other connected components are not turned on.

Automatic function selection

When you connect a CONTROL A1II compatible Sony amplifier (or receiver) to other Sony components using monaural mini-plug cords, the function selector on the amplifier (or receiver) automatically switches to the correct input when you press the play button on one of the connected components.

Notes

- You must connect a CONTROL A1 compatible amplifier (receiver) using a monaural mini-plug cord in order to take advantage of the automatic function selection feature.
- This function only works when the components are connected to the amplifier (or receiver) inputs according to the names on the function buttons. Certain receivers allow you to switch the names of the function buttons. In this case, refer to the Operating Instructions supplied with the receiver.
- When recording, do not play any components other than the recording source. It will cause the automatic function selection to operate.

Synchronized recording

This function lets you conduct synchronized recording between the selected source and recorder components.

- 1** Set the function selector on the amplifier (or receiver) to the source component.
- 2** Set the source component to pause mode (make sure both the ► and ■■ indicators light together).
- 3** Set the recorder component to the REC-PAUSE mode.
- 4** Press PAUSE on the recorder component.
The source component is released from the pause mode, and recording begins shortly thereafter.
When playback ends from the source component, recording stops.

Notes

- Do not set more than one component to the pause mode.
- Certain recorder components may be equipped with a special synchronized recording function that uses the CONTROL A1II Control System, like “CD Synchro Dubbing”. In this case, refer to the Operating Instructions supplied with the recorder component.

Additional Information

Troubleshooting

If you experience any of the following difficulties while using the receiver, use this troubleshooting guide to help you remedy the problem. Also, see “Checking the connections” on page 22 to verify that the connections are correct. Should any problem persist, consult your nearest Sony dealer.

There’s no sound or only a very low-level sound is heard.

- ➔ Check that the speakers and components are connected securely.
- ➔ Make sure that you’ve selected the correct component on the receiver.
- ➔ Press SPEAKERS button if SP. OFF appears on the display.
- ➔ Check that the headphones are not connected to the PHONES jack.
- ➔ Press MUTING if MUTING appears on the display.
- ➔ The protective device on the receiver has been activated because of a short circuit. Turn off the receiver, eliminate the short-circuit problem and turn on the power again.

The left and right sounds are unbalanced or reversed.

- ➔ Check that the speakers and components are connected correctly and securely.
- ➔ Adjust front balance parameter in the LEVEL menu.

Severe hum or noise is heard.

- ➔ Check that the speakers and components are connected securely.
- ➔ Check that the connecting cords are away from a transformer or motor, and at least 3 meters (10 feet) away from a TV set or fluorescent light.
- ➔ Move your TV away from the audio components.
- ➔ Make sure you’ve grounded \hbar SIGNAL GND terminal (only when a turntable is connected).
- ➔ The plugs and jacks are dirty. Wipe them with a cloth slightly moistened with alcohol.

There is intermittent sound from a digital source.

- ➔ Check to see if signals with 96 kHz sampling frequencies are input to the DVD/LD IN OPTICAL or COAXIAL jacks.

No sound is heard from the center speaker.

- ➔ Make sure the sound field function is on (press SOUND FIELD MODE).
- ➔ Select the appropriate center mode (see pages 29–31).
- ➔ Adjust the speaker volume (see page 21).
- ➔ Make sure the center speaker size parameter is set to either SMALL or LARGE (see page 18).

No sound or only a very low-level sound is heard from the surround speakers.

- ➔ Make sure the sound field function is on (press SOUND FIELD MODE).
- ➔ Select the appropriate center mode (see pages 29 – 31).
- ➔ Adjust the speaker volume (see page 21).
- ➔ Make sure the surround speaker size parameter is set to either SMALL or LARGE (see page 18).

No sound is heard from the sub woofer.

- ➔ Make sure the sub woofer is set to YES (see page 18).
- ➔ Check that 2CH mode has not been selected (see page 31).

Dolby Digital or DTS multi channel sound is not reproduced.

- ➔ Check that the playing DVD, etc. is recorded in Dolby Digital or DTS format.
- ➔ When connecting the DVD player, etc. to the digital input jacks of this receiver, check the audio setting (settings for the audio output) of the connected component.

Recording cannot be done.

- ➔ Check that the components are connected correctly.
- ➔ Select the source component by rotating FUNCTION control.
- ➔ When recording from a digital component, make sure the input mode is set to ANALOG 2CH FIXED (see page 25) before recording with a component connected to the analog MD/TAPE terminals.
- ➔ When recording from a digital component, make sure the input mode is set to COAXIAL FIXED or OPTICAL FIXED (see page 25) before recording with the component connected to the DIGITAL MD/TAPE OUT terminals.

Radio stations cannot be tuned in.

- ➔ Check that the antennas are connected securely. Adjust the antennas and connect an external antenna if necessary.
- ➔ The signal strength of the stations is too weak (when tuning in with automatic tuning). Use direct tuning.
- ➔ Make sure you set the tuning interval correctly (when tuning in AM stations with direct tuning) (see pages 44 and 57).
- ➔ No stations have been preset or the preset stations have been cleared (when tuning by scanning preset stations). Preset the stations (see page 45).
- ➔ Press DISPLAY so that the frequency appears in the display.

The surround effect cannot be obtained.

- ➔ Make sure the sound field function is on (press SOUND FIELD MODE).

RDS does not work.

- ➔ Make sure that you're tuned to an FM RDS station.
- ➔ Select a stronger FM station.

The RDS information that you want does not appear.

- ➔ Contact the radio station and find out whether or not they actually provide the service in question. If so, the service may be temporarily out of order.

Nothing appears on the display

- ➔ When the display turns off after the receiver is turned on, press DIMMER to change the display mode.

No picture or an unclear picture appears on the TV screen or monitor.

- ➔ Select the appropriate function on the receiver.
- ➔ Set your TV to the appropriate input mode.
- ➔ Move your TV away from the audio components.

The remote does not function.

- ➔ Point the remote at the remote sensor  on the receiver.
- ➔ Remove any obstacles in the path between the remote and the receiver.
- ➔ Replace both batteries in the remote with new ones, if they are weak.
- ➔ Make sure you select the correct function on the remote.
- ➔ If the remote is set to operate the TV only, use the remote to select a source or component other than TV before operating the receiver or other component.

Reference sections for clearing the receiver's memory

To clear	See
All memorized settings	page 16
Customized sound fields	page 36

Specifications

Amplifier section

POWER OUTPUT

Rated Power Output at Stereo Mode
(8 ohms 1 kHz, THD 0.7 %)
100 W + 100 W

Reference Power Output

(8 ohms 1 kHz, THD 0.7 %)
FRONT¹⁾:
100 W + 100 W
CENTER¹⁾: 100 W
SURROUND¹⁾:
100 W + 100 W

1) Depending on the sound field settings and the source, there may be no sound output.

Frequency response

PHONO: RIAA
equalization curve
±0.5 dB
MULTI CH IN, CD/
SACD, MD/TAPE,
DVD/LD, TV/SAT,
VIDEO 1 and
VIDEO 2:
10 Hz – 50 kHz
+0.5/-2 dB (with
sound field, and
equalizer bypassed)

Inputs (Analog)

PHONO:
Sensitivity: 4 mV
Impedance: 50
kilohms
S/N²⁾: 86 dB
(A, 4 mV³⁾)
MULTI CH IN, CD/
SACD, MD/TAPE,
DVD/LD, TV/SAT,
VIDEO 1 and
VIDEO 2:
Sensitivity: 250 mV
Impedance:
50 kilohms
S/N²⁾: 96 dB
(A, 250 mV³⁾)

2) INPUT SHORT

3) Weighted network, input level

Inputs (Digital)

DVD/LD IN(Coaxial):
Sensitivity: –
Impedance: 75 ohms
S/N: 100 dB
(A, 20 kHz LPF)
DVD/LD IN, TV/SAT
IN, MD/TAPE IN
(Optical):
Sensitivity: –
Impedance: –
S/N: 100 dB
(A, 20 kHz LPF)

Outputs

MD/TAPE (OUT);
VIDEO 1, 2 (AUDIO
OUT):
Voltage: 250 mV,
Impedance:
10 kilohms
SUB WOOFER:
Voltage: 2 V
Impedance:
1 kilohms
PHONES:
Accepts low- and
high-impedance
headphones

Sampling Frequency

48 kHz (TV/SAT,
MD/TAPE
OPTICAL IN)
96 kHz (DVD/LD
OPTICAL IN,
COAXIAL IN)

EQ

BASS:
99 Hz~1.0 kHz
(21 steps)
MID:
198 Hz~10 kHz
(37 steps)
TREBLE:
1.0 kHz~10 kHz
(23 steps)
Gain levels:
+6/-10 dB, 1 dB step

FM tuner section

Tuning range 87.5 - 108.0 MHz

Antenna terminals

75 ohms, unbalanced

Intermediate frequency

10.7 MHz

Sensitivity

Mono: 18.3 dBf,
2.2 µV/75 ohms
Stereo: 38.3 dBf,
22.5 µV/75 ohms

Usable sensitivity

11.2 dBf, 1 µV/75 ohms

S/N

Mono: 76 dB
Stereo: 70 dB

Harmonic distortion at 1 kHz

Mono: 0.3%
Stereo: 0.5%

Separation

45 dB at 1 kHz

Frequency response

30 Hz – 15 kHz
+0.5/-2 dB

Selectivity

60 dB at 400 kHz

AM tuner section

Tuning range	531 – 1602 kHz
Antenna	Loop antenna
Intermediate frequency	450 kHz
Usable sensitivity	50 dB/m (at 999 kHz)
S/N	54 dB (at 50 mV/m)
Harmonic distortion	0.5 % (50 mV/m, 400 Hz)
Selectivity	35 dB

Video section

Inputs	Video: 1 Vp-p 75 ohms
	S-video: Y: 1 Vp-p 75 ohms C: 0.286 Vp-p 75 ohms
Outputs	Video: 1 Vp-p 75 ohms
	S-video: Y: 1 Vp-p 75 ohms C: 0.286 Vp-p 75 ohms

General

System	Tuner section: PLL quartz-locked digital synthesizer system Preamplifier section: Low-noise NF type equalizer Power amplifier section: Pure-complementary SEPP
Power requirements	230 V AC, 50/60 Hz
Power consumption	220 W In standby condition: 0.9 W
AC outlets	1 switched, max 100 W
Dimensions	430 × 157.5 × 369 mm (17 × 6 ¹ / ₈ × 14 ⁴ / ₈ in.) including projecting parts and controls
Mass (Approx.)	9.5 kg (20 lb 16 oz)
Supplied accessories	See page 4.

Design and specifications are subject to change without notice.

Glossary

Surround sound

Sound that consists of three elements: direct sound, early reflected sound (early reflections) and reverberative sound (reverberation). The acoustics of the surrounding space affect the way these three sound elements are heard. Surround sound combines these sound elements in such a way that you actually can sense the size of the venue, as well as its type.

- Types of sound

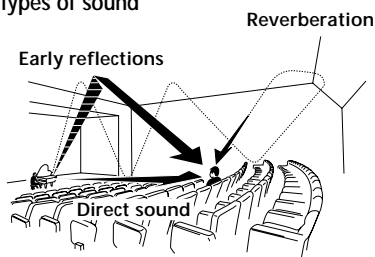

- Transition of sound from surround speakers

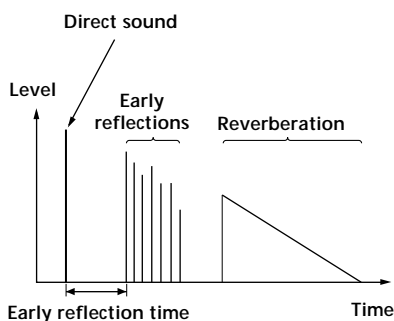

Dolby Pro Logic Surround

As one method of decoding Dolby Surround, Dolby Pro Logic Surround produces four channels from two-channel sound. Compared with the former Dolby Surround system, Dolby Pro Logic Surround reproduces left-to-right panning more naturally and localizes sounds more precisely. To take full advantage of Dolby Pro Logic Surround, you should have one pair of surround speakers and a center speaker. The surround speakers output monaural sound.

Dolby Digital

This sound format for movie theaters is more advanced than Dolby Pro Logic Surround. In this format, the surround speakers output stereo sound with an expanded frequency range and a sub woofer channel for deep bass is independently provided. This format is also called “5.1” because the sub woofer channel is counted as 0.1 channel (since it functions only when a deep bass effect is needed). All six channels in this format are recorded separately to realize superior channel separation. Furthermore, since all the signals are processed digitally, less signal degradation occurs.

Digital Cinema Sound

This is the generic name of the surround sound produced by digital signal processing technology developed by Sony. Unlike previous surround sound fields mainly directed at the reproduction of music, Digital Cinema Sound is designed specifically for the enjoyment of movies.

Tables of Settings Using SURR, LEVEL, EQ, and SET UP buttons

You can make various settings using the LEVEL, SURR, EQ, SET UP buttons, jog dial, and cursor buttons. The tables below show each of the settings that these buttons can make.

Press	Press < or > to select	Turn jog dial to select	Page
SURR	PRO LOGIC	AUTO, ON, OFF	34
	EFFECT	depends on sound field (21 steps)	
	WALL S_I_H	-8 to +8 (1 increment steps)	
	REVERB S_I_L	-8 to +8 (1 increment steps)	
	FRONT REVERB	DRY, WET, STD	
	SCREEN DEPTH	DEEP, MID, OFF	
	VIR. SPEAKERS	ON, OFF	
LEVEL	FRONT L_I_R	-8 dB to +8 dB (1 dB steps)	35
	SURROUND L_I_R	-8 dB to +8 dB (1 dB steps)	
	CENTER LEVEL XXX dB	-10 dB to +6 dB (1 dB steps)	
	SURROUND LEVEL XXX dB	-10 dB to +6 dB (1 dB steps)	
	SURR BACK LEVEL XXX dB	-10 dB to +6 dB (1 dB steps)	
	S. WOOFER LEVEL XXX dB	-10 dB to +6 dB (1 dB steps)	
	LFE MIX XXX dB	OFF, -20 dB to 0 dB (1 dB steps)	
	D. RANGE COMP.	OFF, 0.1 to 0.9 (0.1 steps), STD, MAX	
EQ	FRONT BASS GAIN	-10 dB to +6 dB (1 dB steps)	36
	FRONT BASS FREQUENCY	99 Hz to 1.0 kHz (21 steps)	
	FRONT MID GAIN	-10 dB to +6 dB (1 dB steps)	
	FRONT MID FREQUENCY	198 Hz to 10.0 kHz (37 steps)	
	FRONT TREBLE GAIN	-10 dB to +6 dB (1 dB steps)	
	FRONT TREBLE FREQUENCY	1.0 kHz to 10 kHz (23 steps)	
	CENTER BASS GAIN	-10 dB to +6 dB (1 dB steps)	
	CENTER BASS FREQUENCY	99 Hz to 1.0 kHz (21 steps)	
	CENTER MID GAIN	-10 dB to +6 dB (1 dB steps)	
	CENTER MID FREQUENCY	198 Hz to 10 kHz (37 steps)	
	CENTER TREBLE GAIN	-10 dB to +6 dB (1 dB steps)	
	CENTER TREBLE FREQUENCY	1.0 kHz to 10 kHz (23 steps)	
	SURROUND BASS GAIN	-10 dB to +6 dB (1 dB steps)	
	SURROUND BASS FREQUENCY	99 Hz to 1.0 kHz (21 steps)	
	SURROUND TREBLE GAIN	-10 dB to +6 dB (1 dB steps)	
	SURROUND TREBLE FREQUENCY	1.0 kHz to 10 kHz (23 steps)	
	SURROUND BACK BASS GAIN	-10 dB to +6 dB (1 dB steps)	
	SURROUND BACK BASS FREQUENCY	99 Hz to 1.0 kHz (21 steps)	
	SURROUND BACK TREBLE GAIN	-10 dB to +6 dB (1 dB steps)	
	SURROUND BACK TREBLE FREQUENCY	1.0 kHz to 10 kHz (23 steps)	

Tables of Settings Using SURR, LEVEL, EQ, and SET UP buttons

Press	Press < or > to select	Turn jog dial to select	Page
SET UP	FRONT	LARGE, SMALL	17
	CENTER	LARGE, SMALL, NO	
	SURROUND	LARGE, SMALL, NO	
	SURR BACK	LARGE, SMALL, NO	
	SUB WOOFER	YES, NO	
	FRONT XX.X meter	1.0 meter (3 feet) to 12.0 meters (40 feet) (0.1 meter (1 foot) steps)	
	CENTER XX.X meter	1.0 meter (3 feet) to 12.0 meters (40 feet) (0.1 meter (1 foot) steps)	
	SURROUND XX.X meter	1.0 meter (3 feet) to 12.0 meters (40 feet) (0.1 meter (1 foot) steps)	
	SURR BACK XX.X meter	1.0 meter (3 feet) to 12.0 meters (40 feet) (0.1 meter (1 foot) steps)	
	SUB WOOFER XX.X meter	1.0 meter (3 feet) to 12.0 meters (40 feet) (0.1 meter (1 foot) steps)	
	S.W PHASE	NORMAL, REVERSE	
	DISTANCE UNIT	meter, feet	
	SURR POSI.	SIDE, MIDDLE, BEHIND	
	SURR HEIGHT	HIGH, LOW	
	SURR BACK HGT.	HIGH, LOW	
	FRONT SP > XXX Hz ¹⁾	40 Hz to 200 Hz (10 Hz steps)	
	CENTER SP > XXX Hz ¹⁾	40 Hz to 200 Hz (10 Hz steps)	
	SURROUND SP > XXX Hz ¹⁾	40 Hz to 200 Hz (10 Hz steps)	
	SURR BACK SP > XXX Hz ¹⁾	40 Hz to 200 Hz (10 Hz steps)	
	LFE HIGH CUT > XXX Hz	40 Hz to 200 Hz (10 Hz steps)	
	6.1 CH DECODING	AUTO, ON, OFF	51
	MULTI CH	NONE, Every functions (except for TUNER and PHONO)	
	S.FIELD LINK	ON, OFF	
A1 AUTO POWER	ON, OFF		
AUTO FUNCTION	ON, OFF		

¹⁾ When the speakers are set to SMALL only.

Remote Button Description

You can use the remote to operate the components in your system. The tables below show the settings of each button.

Remote Button	Operations	Function
SLEEP	Receiver	Activates the sleep function and the duration which the receiver turns off automatically.
AV 1/⏻	TV/VCR/ CD player/ DVD player/ MD deck/ VCD player/ LD player/ DAT deck	Turns the audio and video components on or off.
I/⏻	Receiver	Turns the receiver on or off.
VIDEO/ VIDEO 1	Receiver	To watch VCR. (VTR mode 3)
VIDEO 2	Receiver	To watch VCR. (VTR mode 1)
VIDEO 3	Receiver	To watch VCR. (VTR mode 2)
DVD/LD	Receiver	To watch DVD or laser disc.
TV/SAT	Receiver	To watch TV programs or satellite receiver.
MD/TAPE	Receiver	To listen to Minidisc or audio tape.
CD/SACD	Receiver	To listen to compact disc.
TUNER	Receiver	To listen to radio programs.
PHONO	Receiver	To listen to turn table.
AUX	Receiver	To listen to an audio equipment.
FN SHIFT*	Remote	Use simultaneously to select other function.
0-9	Receiver	Use with "SHIFT" button to select tuner preset station numeric input during DIRECT TUNING or MEMORY mode.
	CD player/ MD deck/ VCD player/ LD player/ DAT deck	Selects track numbers. 0 selects track 10.
	TV/VCR/SAT	Selects channel numbers.
>10	CD player/ MD deck/ Tape deck/ LD player/ VCD player	Selects tracks numbers over 10.

Remote Button	Operations	Function
ENTER	TV/VCR/SAT/ Tape deck/ LD player/ VCD player/ MD deck/ DAT deck	After selecting a channel, disc or track using the numeric buttons, press to enter the value.
SHIFT	Receiver	Press repeatedly to select a memory page for presetting radio stations or tuning to preset stations.
-/--	TV	Selects the channel entry mode, either one or two digit.
D.TUNING	Receiver	Tuner station direct key-in mode.
◀▶	CD player/ MD deck/ DVD player/ LD player/ VCD player/ Tape deck/VCR/ DAT deck	Skips tracks.
◀▶	CD player/ DVD player/ VCD player	Searches tracks (forward or backward).
	MD deck/ Tape deck/ VCR/ LD player/ DAT deck	Fastforwards or rewinds.
◀	Tape deck	Starts play on the reverse side.
▶	CD player/ MD deck/Tape deck/VCR/ DVD player/ VCD player/ LD player/ DAT deck	Starts play.

* VIDEO 1, VIDEO 2, VIDEO 3, PHONO and MD/TAPE function is a 2-key operation. To select the above function, press FN SHIFT (function shift) and the function key you want simultaneously. For example, press FN SHIFT and CD/SACD to select MD/TAPE function.

Note

When you press the function buttons (VIDEO, DVD/LD, TV/SAT), the input mode of the TV might not switch to the corresponding input mode that you want. In this case, press the TV/VIDEO button to switch the input mode of the TV.

Remote Button Description

Remote Button	Operations	Function
■	CD player/ MD deck/Tape deck/VCR/ DVD player/ VCD player/ LD player/ DAT deck	Pauses play or record. (Also starts recording with components in record standby.)
■	CD player/ MD deck/Tape deck/VCR/ DVD player/ VCD player/ LD player/ DAT deck	Stops play.
POSITION**	TV	Changes the position of the small picture.
SWAP**	TV	Swaps the small and the large picture.
DISC	CD player	Select discs (multi-disc changer only).
SUB CH +/-**	TV	Selects preset channels for the small picture.
D. SKIP/CH/ PRESET +/-	Receiver	Scans and selects preset stations.
	TV/VCR/SAT	Selects preset channels.
	CD player	Skips discs (multi-disc changer only).
DISPLAY	TV/VCR/ LD player/ DVD player/ VCD player	Selects information displayed on the TV screen.
P IN P**	TV	Activates the picture-in- picture function.
JUMP	TV	Toggles between the previous and the current channels.
WIDE	TV	Selects the wide picture mode.
ANT TV/VTR	VCR	Selects output signal from the aerial terminal: TV signal or VCR program.
TV/VIDEO	TV/VCR	Selects input signal: TV input or video input.
A. F. D.	Receiver	Auto Format Decoding.
2CH/OFF	Receiver	Turns off sound field or selects 2CH mode.
MODE +/-	Receiver	Selects sound field mode.
MULTI /2CH A. DIRECT	Receiver	Selects MULTI CH IN and 2CH ANALOG DIRECT source.
MUTING	Receiver	Mutes the sound from the receiver.

Remote Button	Operations	Function
TEST TONE	Receiver	Press to output test tone.
MAIN MENU	Receiver	Press this button repeatedly to select one of the five cursor modes: LEVEL, SURROUND, EQ, NAME and SET UP.
MASTER VOL +/-	Receiver	Adjusts the master volume of the receiver.
MENU </>	Receiver	Selects a menu item.
MENU +/-	Receiver	Makes adjustment or change the setting.
MENU	DVD player	Displays DVD menu.
⏪/⏩/⏴/⏵	DVD player	Selects a menu item.
ENTER	DVD player	Enters the selection.
RETURN	DVD player	Returns to the previous menu or exits the menu.
TITLE	DVD player	Displays DVD title.

** Only for Sony TVs with the picture-in-picture function.

Notes

- Some functions explained in this section may not work depending on the model of the receiver.
- The above explanation is intended to serve as an example only. Therefore, depending on the component the above operation may not be possible or may operate differently than described.
- The VIDEO, VIDEO 3 and AUX functions are not available for set operation.

Changing the factory setting of a function button

If the factory settings of the FUNCTION buttons don't match your system components, you can change them. For example, if you have an MD player and a tape deck and you don't have a CD player, you can assign the CD/SACD button to your tape deck.

Note that the settings of the TUNER and FN SHIFT functions (VIDEO 1, VIDEO 2, VIDEO 3, PHONO and MD/TAPE) button cannot be changed.

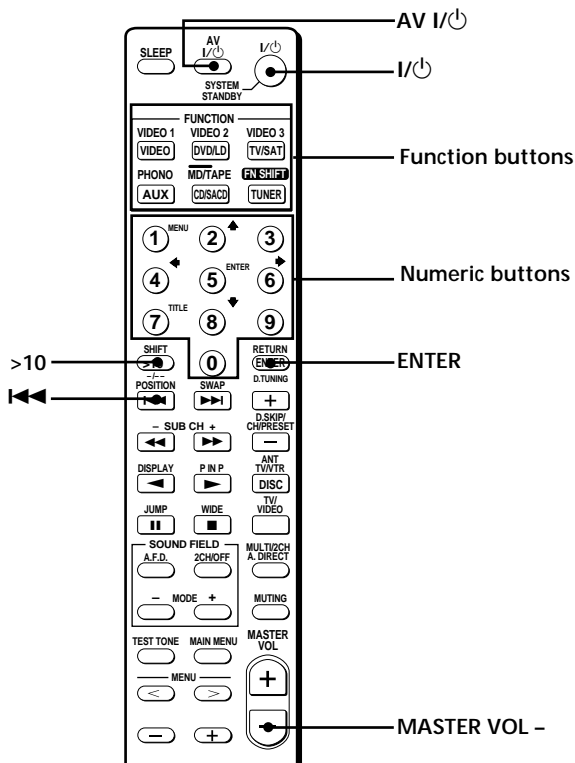

- 1 Hold down the Function button whose function you want to change (for example, CA/SACD).
- 2 Press the corresponding button of the component you want to assign to the Function button (for example, 4 - tape deck).

The following buttons are assigned to select the functions:

To operate	Press
CD player	1
DAT deck	2
MD deck	3
Tape deck A	4
Tape deck B	5
LD player	6
VCR (remote control mode VTR 1*)	7
VCR (remote control mode VTR 2*)	8
VCR (remote control mode VTR 3*)	9
TV	0
DSS (Digital Satellite Receiver)	>10
DVD	ENTER
VCD player	⏮

* Sony VCRs are operated with a VTR 1, 2 or 3 setting. These correspond to Beta, 8mm and VHS respectively.

Now you can use the CD/SACD button to control the tape deck.

To reset a button to its factory setting
Repeat the above procedure.

To reset all the function buttons to their factory setting
Press I/⏻, AV I/⏻ and MASTER VOL - at the same time.

Index

A

- Adjusting
 - brightness of the display 24
 - equalizer 36
 - speaker volumes 21
 - surround parameters 34
- Autobetical 44
- Automatic tuning 45

B

- Basic operations 23~27
- Battery 4

C

- Changing
 - display 23
 - effect level 34
- Checking the connections 22
- Clearing receiver's memory 16
- Connecting 4~15
- Crossover frequency 21
- Customizing sound fields 34~41

D

- Digital Cinema Sound 58
- Direct tuning 44
- Dolby Digital 58
- Dolby Pro Logic Surround 58
- Dubbing. *See Recording*

E, F, G

- Editing. *See Recording*
- Effect level 34
- EQ 36

H

- Hookups
 - AC power cord 11
 - antennas 5
 - audio components 6
 - digital components 8
 - CONTROL A1 II 12
 - MULTI CH IN 10
 - video components 7

I, J, K

- Indexing. *See Naming*

L, M

- Labeling. *See Naming*

N, O

- Naming 49

P, Q

- Parameter 37~41
- Preset stations
 - how to preset 45
 - how to tune 46
- PTY 47

R

- RDS 46~47
- Receiving broadcasts
 - automatically 45
 - directly 44
 - preset stations 45
- Recording
 - on an audio tape or MD 49
 - on a video tape 50

S

- Scanning
 - preset stations. *See Preset tuning*
 - radio stations. *See Automatic tuning*
- Selecting
 - component 25
 - sound field 29
- Sleep timer 50
- Sound field
 - adjustable parameters 37, 41
 - customizing 34~41
 - pre-programmed 30~31
 - resetting 36
 - selecting 29
- Speakers
 - adjusting speaker volume 21
 - connection 14
 - impedance 15
 - placement 17~21
- Supplied accessories 4
- Surround sound 28~41

T

- Test tone 21
- Troubleshooting 54
- Tuning
 - automatically 45
 - directly 44
 - preset stations 45

U, V, W, X, Y, Z

- Unpacking 4