

For details, refer to the Operating Instructions.  
Para mais detalhes, consulte o Manual de Instruções.

## Quick Setup Guide/Guia de Instalação Rápida

DAV-DZ330

### 1 Connecting the speakers/Ligar as colunas

Connect the speaker cords to match the color of the **SPEAKERS** jacks of the unit.  
Ligue os cabos das colunas de acordo com a cor das tomadas **SPEAKERS** da unidade.

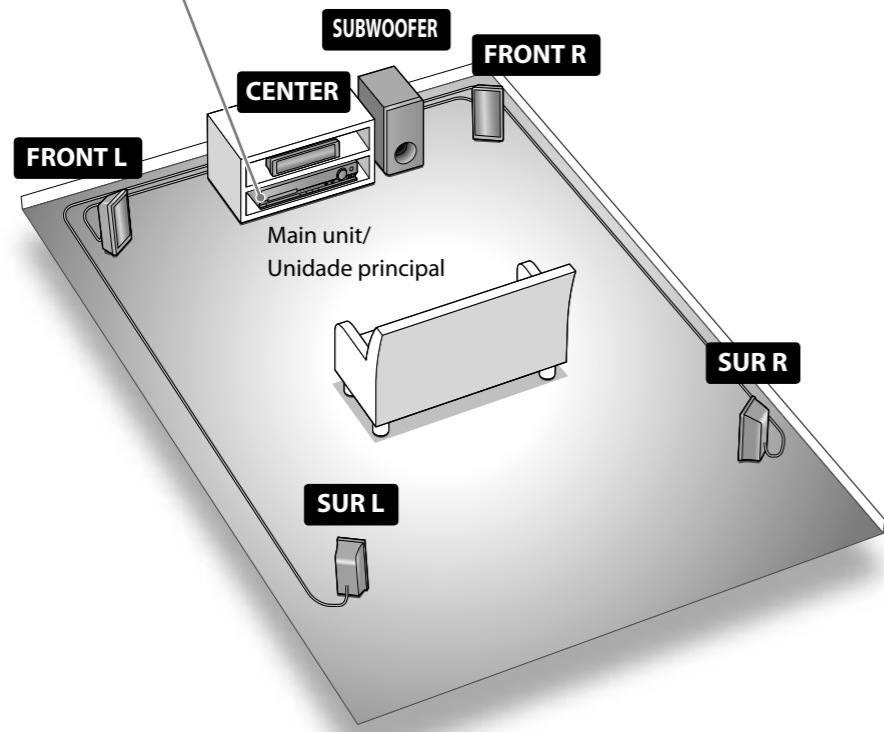
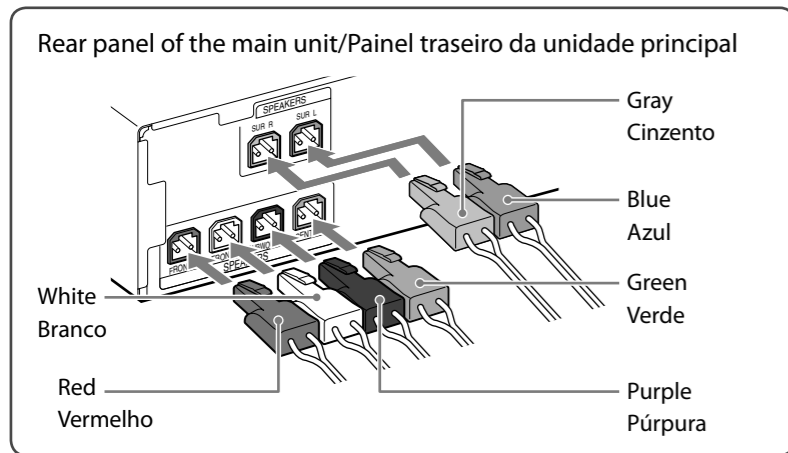

To connect speaker cords to the speaker/  
Ligar os cabos das colunas às colunas

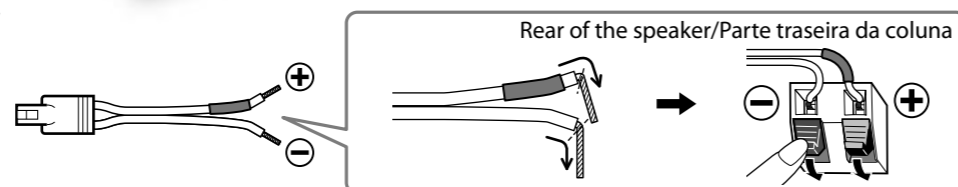

### 2 Connecting your TV/set-top box/Ligar o seu televisor/set-top box

Depending on the jacks on your TV or set-top box, select the video and audio connection method.  
Dependendo das tomadas do seu televisor ou set-top box, seleccione o método de ligação vídeo e áudio.

#### Connecting the video to your TV/Ligar o vídeo ao seu televisor

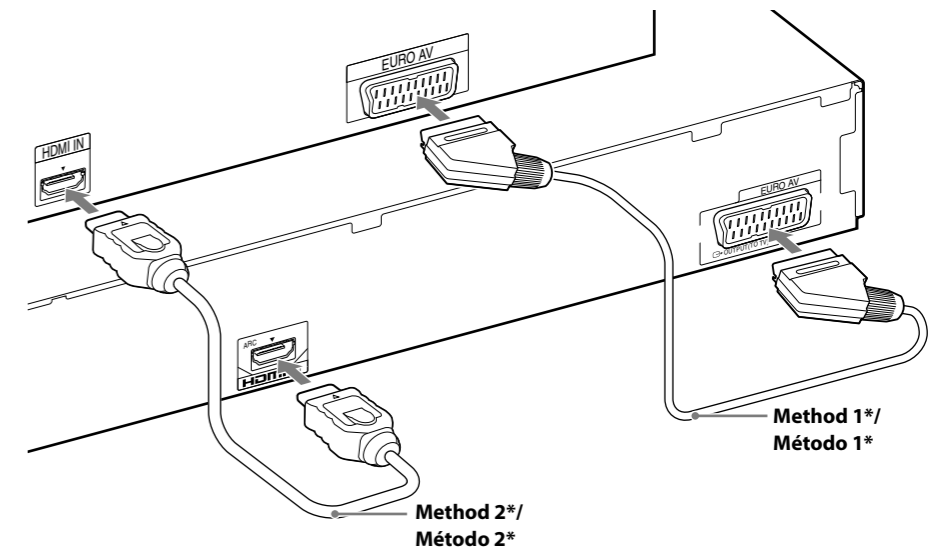
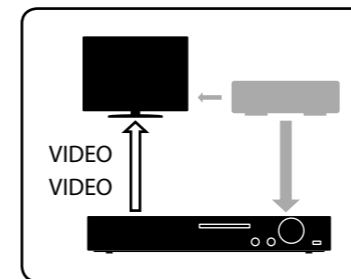

\*Not supplied/\*Não fornecido

#### Connecting the audio from your set-top box/Ligar o áudio da sua set-top box

If you do not use a set-top box, refer to "Connecting your TV/set-top box" in the Operating Instructions.  
Se não utilizar uma set-top box, consulte "Ligar o seu televisor/set-top box" no Manual de Instruções.

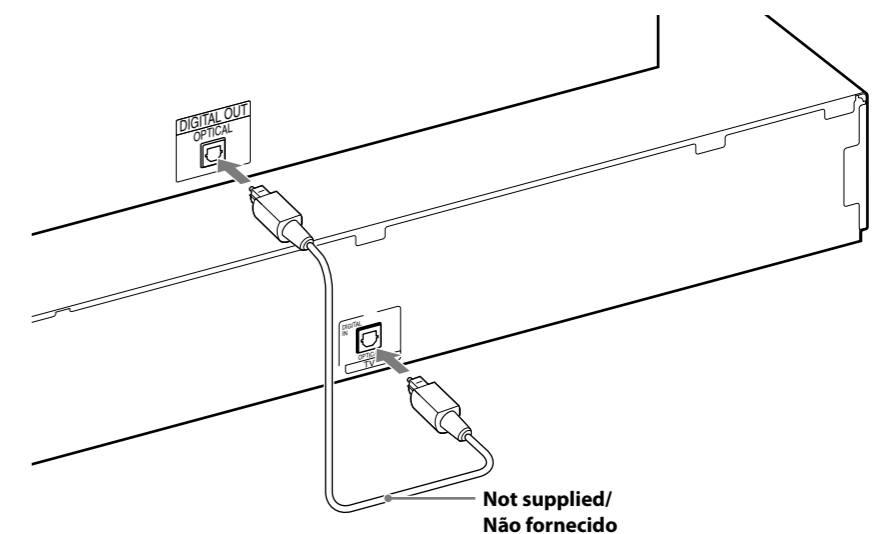
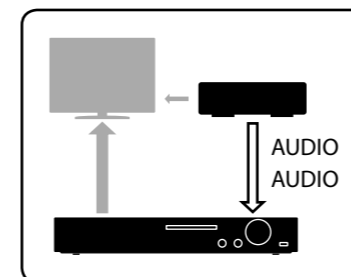

Not supplied/  
Não fornecido

# 3 Performing the Quick Setup/Realização da Instalação rápida

**Note**  
Do not insert a disc before performing the Quick Setup.

**Nota**  
Não introduza um disco antes de realizar a Instalação Rápida.

**1 Connect the AC power cord.**  
The shape of the wall outlet differs depending on the area.

**Ligue o cabo de alimentação CA.**  
O formato da tomada de parede pode variar consoante a região.

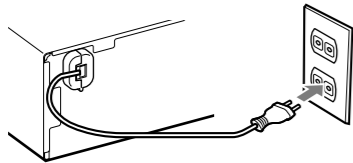

**2 Turn on the power of the main unit and TV.**  
**Ligue a alimentação da unidade principal e o televisor.**

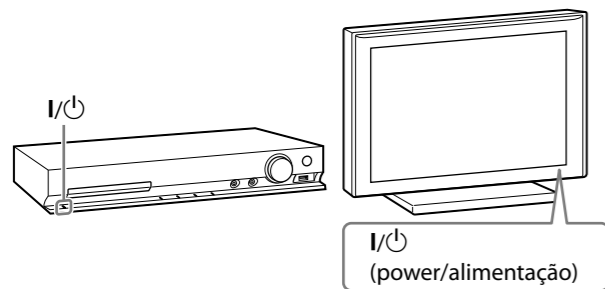

**3 Switch the input selector on your TV to display "SONY Home Theatre System."**

Regule o selector de entrada do televisor de modo a ser exibido "SONY Home Theatre System."

**4 Set each following item, using ←/↑/↓/→ and +.**

Configure cada um dos seguintes itens utilizando ←/↑/↓/→ e +.

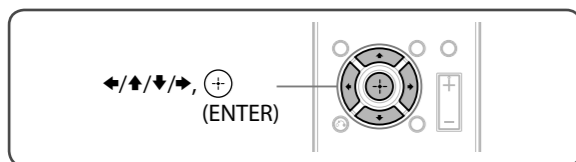

**Note**  
Displayed items vary depending on the area.

**Nota**  
Os itens apresentados variam consoante a região.

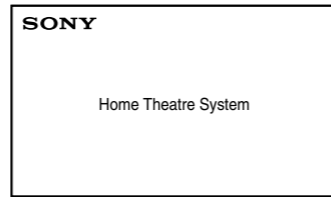

Select an on-screen language.

Seleccione um idioma de visualização no ecrã.

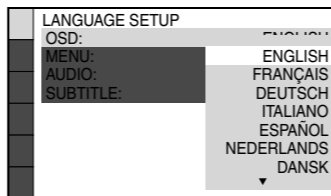

Select the aspect ratio of the connected TV.

Seleccione o formato do televisor ligado.

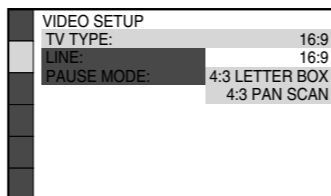

Select the output method for video signals.

Seleccione o método de saída para sinais de vídeo.

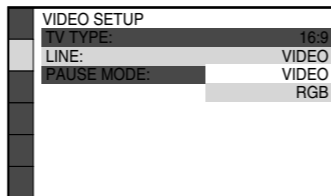

Select [ON] when you connect the main unit and the TV with an HDMI cable.

Seleccione [ACTIVADO] quando ligar a unidade principal e o televisor com um cabo HDMI.

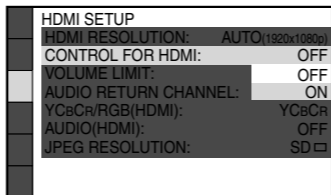

Select the speaker formation.

Seleccione a formação das colunas.

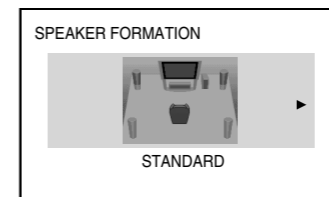

Connect the calibration mic and set it at the listening position.

Ligue o microfone de calibragem e regule-o para a posição de audição.

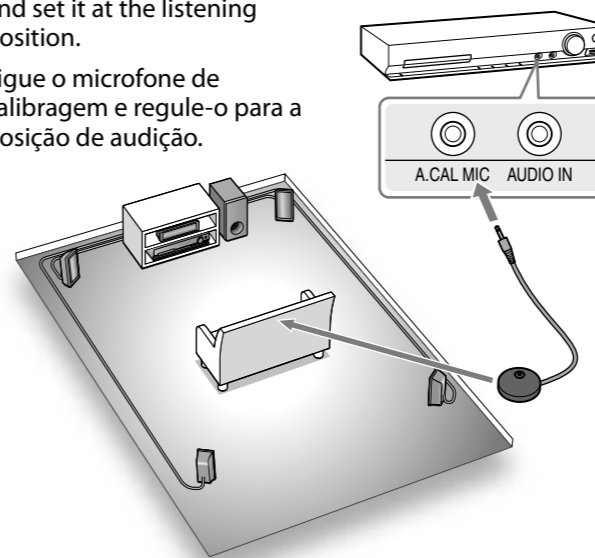

Select [YES] to perform [AUTO CALIBRATION].

Seleccione [SIM] para realizar [CALIBRAGEM AUTO].

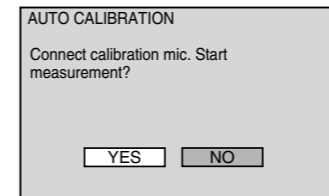

Select [YES] to save the measurement results.

Seleccione [SIM] para guardar os resultados da medição.

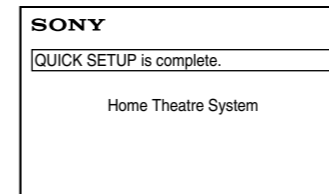
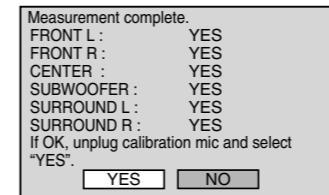

Listening to TV sound from all speakers/  
Ouvir som do televisor a partir de todas as colunas

**1 Press TV.**  
**Prima TV.**

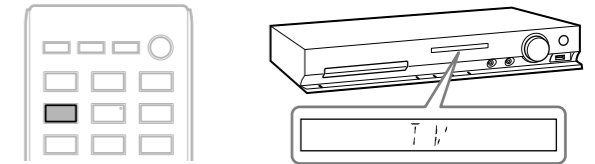

**2 Press SYSTEM MENU.**  
**Prima SYSTEM MENU.**

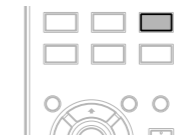

**3 Press ↑/↓ to display "SUR.SETTING," then press +.**

Prima ↑/↓ para apresentar "SUR.SETTING," e prima +.

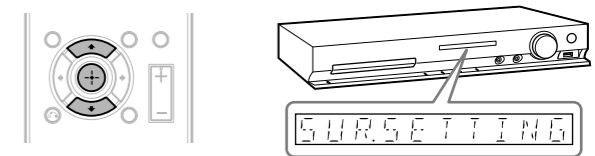

**4 Press ↑/↓ to display "PRO LOGIC," then press +.**

Prima ↑/↓ para apresentar "PRO LOGIC," e prima +.

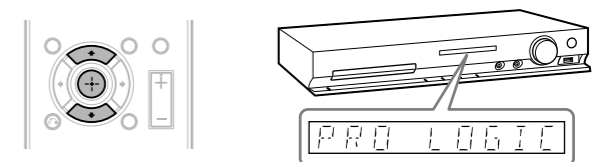

**5 Press SYSTEM MENU to exit the menu.**  
**Prima SYSTEM MENU para sair do menu.**

