

Portable CD/DVD Player

Operating Instructions



To find out useful hints, tips and information about Sony products and services please visit:

www.sony-europe.com/myproduct/



DVP-FX740DT

WARNING

To reduce the risk of fire or electric shock, do not expose this apparatus to rain or moisture.

To avoid electrical shock, do not open the cabinet. Refer servicing to qualified personnel only.

The mains lead must be changed only at a qualified service shop.

Batteries or batteries installed apparatus shall not be exposed to excessive heat such as sunshine, fire or the like.



This label is located on the bottom of the unit.

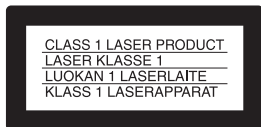

This appliance is classified as a CLASS 1 LASER product. The CLASS 1 LASER PRODUCT MARKING is located on the bottom of the unit.

CAUTION

- The use of optical instruments with this product will increase eye hazard. As the laser beam used in this CD/DVD player is harmful to eyes, do not attempt to disassemble the cabinet. Refer servicing to qualified personnel only.
- Danger of explosion if battery is incorrectly replaced. Replace only with the same or equivalent type.



Disposal of Old Electrical & Electronic Equipment
(Applicable in the European Union and other European countries with separate collection systems)

This symbol on the product or on its packaging indicates that this product shall not be treated as household waste. Instead it shall be handed over to the applicable collection point for the recycling of electrical and electronic equipment. By ensuring this product is disposed of correctly, you will help prevent potential negative consequences for the environment and human health, which could otherwise be caused by inappropriate waste handling of this product. The recycling of materials will help to conserve natural resources. For more detailed information about recycling of this product, please contact your local Civic Office, your household waste disposal service or the shop where you purchased the product.



Pb

Disposal of waste batteries
(applicable in the European Union and other European countries with separate collection systems)

This symbol on the battery or on the packaging indicates that the battery provided with this product shall not be treated as household waste.

On certain batteries this symbol might be used in combination with a chemical symbol. The chemical symbols for mercury (Hg) or lead (Pb) are added if the battery contains more than 0.0005% mercury or 0.004% lead.

By ensuring these batteries are disposed of correctly, you will help prevent potentially negative consequences for the environment and human health which could otherwise be caused by inappropriate waste handling of the battery. The recycling of the materials will help to conserve natural resources.

In case of products that for safety, performance or data integrity reasons require a permanent connection with an incorporated battery, this battery should be replaced by qualified service staff only.

To ensure that the battery will be treated properly, hand over the product at end-of-life to the applicable collection point for the recycling of electrical and electronic equipment.

For all other batteries, please view the section on how to remove the battery from the product safely. Hand the battery over to the applicable collection point for the recycling of waste batteries.

For more detailed information about recycling of this product or battery, please contact your local Civic Office, your household waste disposal service or the shop where you purchased the product.

Do not take apart or remodel the player. Doing so can result in electric shock. Consult your nearest Sony dealer or Sony Service Center for exchange of rechargeable batteries, internal checks or repair.

Precautions

- Install this system so that the mains lead can be unplugged from the wall socket immediately in the event of trouble.
- The player is not disconnected from the AC power source (mains) as long as it is connected to the wall outlet, even if the player itself has been turned off.
- To prevent fire or shock hazard, do not place objects filled with liquids, such as vases, on the apparatus.
- Excessive sound pressure from earphones and headphones can cause hearing loss.

The manufacturer of this product is Sony Corporation, 1-7-1 Konan Minato-ku Tokyo, 108-0075 Japan. The Authorized Representative for EMC and product safety is Sony Deutschland GmbH, Hedelfinger Strasse 61, 70327 Stuttgart, Germany. For any service or guarantee matters please refer to the addresses given in separate service or guarantee documents.

IMPORTANT NOTICE

Caution: This player is capable of holding a still video image or on-screen display image on your television screen indefinitely. If you leave the still video image or on-screen display image displayed on your TV for an extended period of time you risk permanent damage to your television screen. Plasma display panel televisions and projection televisions are susceptible to this.

If you have any questions or problems concerning your player, please consult your nearest Sony dealer.

Copyrights, licencing and trademarks

- Manufactured under licence from Dolby Laboratories. Dolby and the double-D symbol are trademarks of Dolby Laboratories.
- “DVD+RW,” “DVD-RW,” “DVD+R,” “DVD+R DL,” “DVD-R,” “DVD VIDEO,” and “CD” logos are trademarks.
- MPEG Layer-3 audio coding technology and patents licensed from Fraunhofer IIS and Thomson.
- DivX, DivX Certified, and associated logos are trademarks of DivX, Inc. and are used under licence.
- THIS PRODUCT IS LICENSED UNDER THE MPEG-4 VISUAL PATENT PORTFOLIO LICENSE FOR THE PERSONAL AND NON-COMMERCIAL USE OF A CONSUMER FOR DECODING VIDEO IN COMPLIANCE WITH THE MPEG-4 VISUAL STANDARD (“MPEG-4 VIDEO”) THAT WAS ENCODED BY A CONSUMER ENGAGED IN A PERSONAL AND NON-COMMERCIAL ACTIVITY AND/OR WAS OBTAINED FROM A VIDEO PROVIDER LICENSED BY MPEG LA TO PROVIDE MPEG-4 VIDEO. NO LICENSE IS GRANTED OR SHALL BE IMPLIED FOR ANY OTHER USE. ADDITIONAL INFORMATION INCLUDING THAT RELATING TO PROMOTIONAL, INTERNAL AND COMMERCIAL USES AND LICENSING MAY BE OBTAINED FROM MPEG LA, LLC. SEE [HTTP://WWW.MPEGLA.COM](http://WWW.MPEGLA.COM)

About this manual



- In this manual, “disc” is used as a general reference for the DVDs or CDs unless otherwise specified by the text or illustrations.
- Icons, such as , listed at the top of each explanation indicate what kind of media can be used with the function being explained. For details, see “Playable Media” (page 34).
- NEED-to-know information (to prevent incorrect operation) is listed under the  icon. NICE-to-know information (tips and other useful information) is listed under the  icon.

Table of Contents

WARNING	2
Guide to Parts and Controls	5
<hr/>	
Preparations	9
Checking the Accessories	9
Charging the Rechargeable Battery	9
Using the Car Battery Adaptor	10
Connecting to a TV	11
<hr/>	
Playback	12
Playing Discs	12
Playing MP3, JPEG, and Video Files	15
Adjusting the Picture Size and Quality	17
<hr/>	
Watching TV	19
Setting the channel	19
Watching TV	20
Using the TV Setup Display	21
<hr/>	
Settings and Adjustments	24
Using the Setup Display	24
<hr/>	
Additional Information	28
Troubleshooting	28
Precautions	31
Playable Media	34
Specifications	36
Index	37

Guide to Parts and Controls

For more information, see the pages indicated in parentheses.

Player

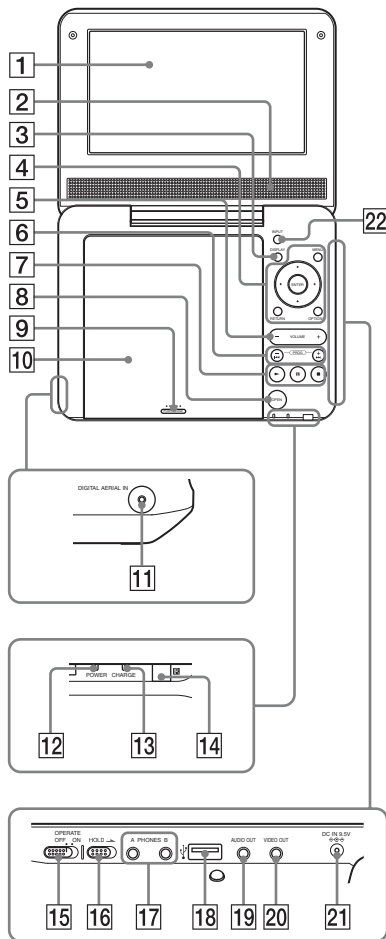

The VOLUME + and ► (play) buttons have a tactile dot. Use the tactile dot as a reference when operating the player.

1 LCD panel (page 12)

2 Speaker

3 DISPLAY button

- When playing a DVD: Displays the playback information and changes the playback mode. See page 14.
- When playing a CD or video file: Displays the playback information. Each time you press the button, the time information switches.
- When playing a VIDEO CD: Displays the playback information.
- When watching a TV: Displays the programme information. Each time you press the button, switches between display of information, more detailed information, and not to display.

4 MENU button

- When playing a DVD: Displays the menu.
- When playing a CD or VIDEO CD: Each time you press the button, switches Repeat Play, Random Play, and Play. (Only when "PBC" is set to "Off" for VIDEO CD.)
- When playing a JPEG file: Displays the list of thumbnails and plays a slideshow. See page 16.

←/↑/↓/→ button

Moves the highlight to select a displayed item.

- When playing a DVD or CD or VIDEO CD: ←/→ on the player works as the same as ◀/▶ on the remote.

ENTER button

Enters the selected item.

- When playing a DVD or CD or VIDEO CD: ENTER on the player works as the same as .
- When watching a TV: Displays the Channel List. See page 20.

RETURN button

Returns to the previous display.

OPTIONS button

Displays the menu for adjusting the LCD screen (page 17) and using the setup display (page 21, 24).

5 VOLUME (sound volume) +/- button

Adjusts the volume.

6 (previous)/PROG - button

Skips to the beginning of the current chapter/track/scene.

To go to the beginning of the previous chapter/track/scene, press twice.

- When watching a TV: Selects a channel you want to watch.

(next)/PROG + button

Skips to the next chapter/track/scene.

- When watching a TV: Selects a channel you want to watch.

7 (play) button (page 12)

Starts or re-starts playback.

(pause) button (page 12)

Pauses or re-starts playback.

(stop) button (page 12)

Stops playback.

8 OPEN button (page 12)

Opens the disc lid.

9 PUSH CLOSE (page 12)

Closes the disc lid.

10 Disc Lid (page 12)

11 DIGITAL AERIAL IN jack (page 19)

12 POWER indicator (page 12)

13 CHARGE indicator (page 9)

14 (remote sensor)

When operating by the remote, point it at the remote sensor .

15 OPERATE switch (page 12)

Turns the player on or off.

16 HOLD switch

To avoid accidental button operation of the player, set the HOLD switch to the direction of the arrow.

All the buttons on the player are locked, while the buttons on the remote remain operable.

17 PHONES (headphone) jack A, B

18 USB jack (type A) (page 16)

Connect a USB device to this jack.

19 AUDIO OUT jack (page 11)

20 VIDEO OUT jack (page 11)

21 DC IN 9.5V jack (page 9, 10)

Connect the AC power adaptor or car battery adaptor.

22 INPUT button (page 16, 19)

Displays mode options when you press the button. Select a mode by pressing \uparrow/\downarrow and ENTER.

- “Disc” mode (default): When playing an inserted disc.
- “USB” mode: When playing DATA files on a connected USB device.
- “TV” mode: When watching a TV.

Remote

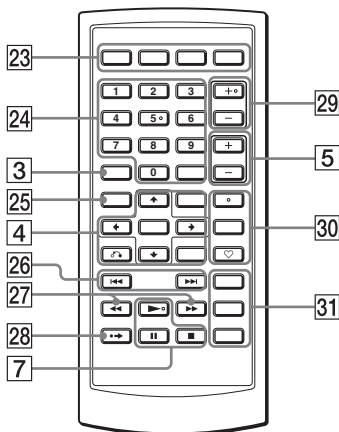

The number 5, \blacktriangleright and AUDIO buttons have a tactile dot. Use the tactile dot as a reference when operating the player.

23 Colour buttons (red/green/yellow/blue)

Activates the function indicated in the same colour on the screen.

24 Number buttons

Enters the title/chapter numbers, etc.

- When playing a DVD VIDEO or CD or VIDEO CD: Search directly by entering the title/chapter/track number using the number buttons, and press ENTER. (Only when “PBC” is set to “Off” for VIDEO CD.)

To switch a title or chapter, press \leftarrow/\rightarrow .

- When watching a TV: Selects a channel.

CLEAR button

Clears the entry field.

25 TOP MENU button

Displays the menu or changes the playback mode.

- When playing a DVD VIDEO: Displays the top menu.
- When playing a DVD VR: Switches between “Original” and “Play List” on the disc created Playlist. During playback, you cannot switch. Press \blacksquare twice, and press TOP MENU.

26 \lll PREV/ \ggg NEXT buttons

Skips to the previous/next chapter, etc.

27 \lll/\ggg (scan/slow) buttons

Fast reverses/ fast forwards when pressed during playback.

Press repeatedly to change the speed.

- When playing a DVD: Slow reverses/ slow forwards when pressed during pause. Press repeatedly to change the speed.
- When playing a VIDEO CD or video file: Slow forwards when pressed during pause. Press repeatedly to change the speed.

28 **↔ ADVANCE button**

Briefly fast forwards the current scene (DVD only).

29 **PROG (programme) +/- buttons**

Selects a TV channel.

30 **AUDIO button**

- When playing a DVD VIDEO: Each time you press the button, the language of the sound track switches. Depending on the disc, the choice of language varies.
- When playing a DVD VR: Each time you press the button, the type of sound tracks recorded on a disc switches between main, sub and main/sub sound.
- When playing a CD or VIDEO CD: Each time you press the button, the mode switches between stereo and monaural (left/right).
- When playing a DivX video file: Each time you press the button, the audio signal switches. If “No Audio” appears, the player does not support the audio signal.
- When watching a TV: Each time you press the button, the audio selecting screen appears or disappears. Press ↔ to switch between stereo and monaural. Press ↑/↓ to select a language.

SUBTITLE button

- When playing a DVD: Each time you press the button, the subtitle switches. Depending on the disc, the choice of language varies.
- When playing a DivX video file: Press the button during playback. Press ↑/↓ and ENTER while displaying subtitle information.
- When watching a TV: Each time you press the button, the subtitle selecting screen appears or

disappears. Press ↔ to display or not to display the subtitle. Press ↑/↓ to select a subtitle language.

ANGLE/♥ (favourite) button

- When playing a DVD VIDEO: Changes the angle. When “” (Angle Mark) appears, you can change angles. Depending on the disc, you may not be able to change the angle.
- When watching a TV: Each time you press the button, add or delete the current channel on the Favourite List (page 20).

31 **TV/RADIO button**

Toggles between TV and radio channels with each press.

This button function is not available for some channels.

 (text) button

Displays the Teletext screen.

This button function is not available in some areas.

GUIDE button

Displays the EPG (Electronic Programme Guide).

Checking the Accessories

Check that you have the following items:

- AC power adaptor (1)
- Car battery adaptor (1)
- Audio/video cord (mini plug × 2 ↔ phono plug × 3) (1)
- Remote (with battery) (1)
- Aerial (1)

To replace the remote battery

When the battery becomes depleted, operation is not possible. Change the battery.

- 1 Prepare a new battery (lithium battery CR2025).
- 2 Pull out the battery holder (2) while pressing the lock lever (1).

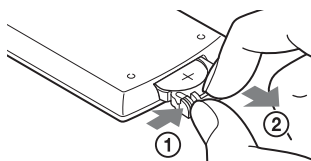

- 3 Remove the old battery.
- 4 Insert the new battery in the battery holder with the ⊕ side up and then push the holder until it clicks.

Charging the Rechargeable Battery

Charge the rechargeable battery before using the player for the first time, or when the battery is depleted.

1 Connect the AC power adaptor.

When charging begins, the CHARGE indicator lights up in orange.

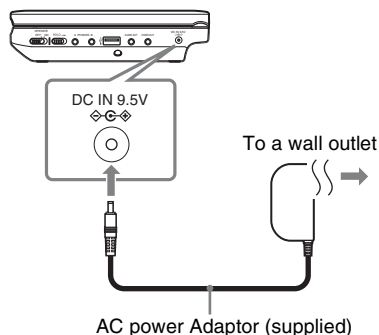

When charging ends, the CHARGE indicator lights off.
Disconnect the AC power adaptor.



If the POWER indicator lights up instead of the CHARGE indicator, the OPERATE switch is set to "ON." Set the OPERATE switch to "OFF," and make sure that the CHARGE indicator lights up.



Charge the battery in an ambient temperature of between 5°C to 35°C.

Charging time and playing time

Charging time: approx. 5 hours

Playing time: approx. 5 hours

Times indicated are under the following conditions:

– Moderate temperature (20°C)

– Headphone use

– Backlight set to minimum

Depending on the ambient temperature or rechargeable battery condition, charging time may be longer, or playing time may be reduced.

To check the battery level

When the player is stopped, the battery indicator is displayed. When the battery is empty,  is displayed or the CHARGE indicator flashes. Set the OPERATE switch to “OFF,” connect the AC power adaptor, and recharge the battery.



Using the Car Battery Adaptor

The car battery adaptor (supplied) is for a 12V car battery, negative earth (do not use it with a 24V car battery, positive earth).

1 Start the engine.

2 Connect the car battery adaptor.

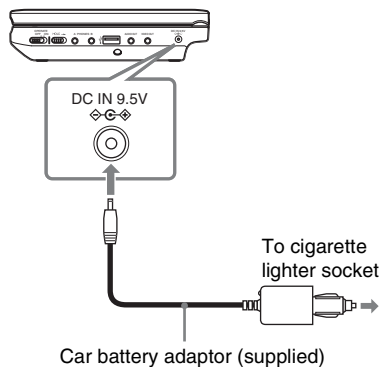

3 Turn on the player.



- The driver should not connect or disconnect the car battery adaptor while driving.
- Arrange the cord so as not to interfere with the driver. Also, do not place the LCD panel where the driver can watch.
- Clean the cigarette lighter socket. If it is dirty, it may cause contact failure or malfunction.
- Use the car battery adaptor with the car engine running. If it is used with the car engine off, the car battery may become depleted.

After using the player in a car

- 1 Turn off the player.
- 2 Disconnect the car battery adaptor.
- 3 Turn off the engine.



- Do not disconnect the car battery adaptor or turn off the car engine before you turn off the player. Doing so may damage the player.
- Disconnect the car battery adaptor after use. If it is left connected, the car battery may become depleted.
- Do not leave the player or accessories in the car.

Connecting to a TV

By connecting the player to your TV or monitor, you can increase your viewing options.

- 1 **Connect the player to your TV or monitor using the audio/video cord (supplied).**

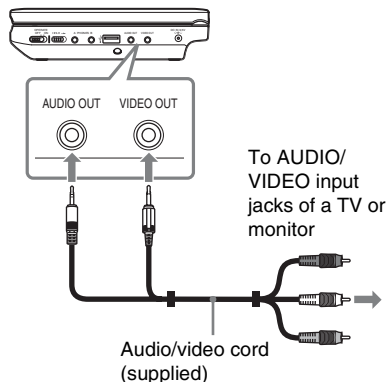

The player can connect to an AV amplifier in the same way as a TV. Although connecting is the same as a TV, the yellow plug of the audio/video cord is not used.



- Refer to the instructions supplied with the equipment to be connected.
- Before connecting, turn off the player and the equipment to be connected, then unplug from their wall sockets.

Playing Discs

DVDVideo **DVD**VR **VCD** **CD**

DATA

Depending on the disc, some operations may be different or restricted. Refer to the operating instructions supplied with the disc.

Connect the AC power adaptor.

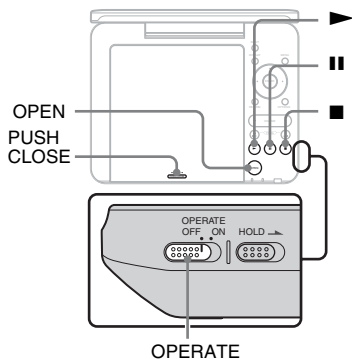

1 Open the LCD panel.

2 Slide the **OPERATE** switch to "ON."

The player turns on and the **POWER** indicator lights up in green.

3 Press **OPEN** to open the disc lid.

4 Insert the disc to be played.

Place with the playback side down and push gently until it clicks.

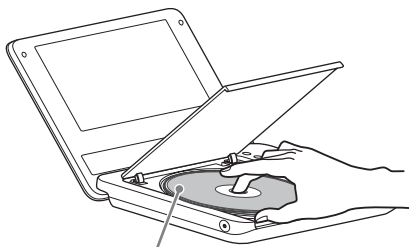

Playback side facing down

5 Push the **PUSH CLOSE** on the disc lid to shut the disc lid.

6 Press **▶**.

The player starts playback. Depending on the disc, a menu may appear. Press **←/↑/↓/→** to select the item, and press **ENTER**.

To stop playback

Press **■**.

To pause playback

Press **⏸**.



When you play back a disc after enjoying images by "USB" or "TV," press **INPUT** to select "Disc." See page 7.



- Discs created on DVD recorders must be correctly finalised to play on the player. For more information about finalising, refer to the operating instructions supplied with the DVD recorder.
- The disc may be still spinning when the disc lid is opened. Wait until the spinning stops before removing the disc.

Notes on the screen saver

- A screen saver image appears when you leave the player in pause or stop mode without operation for more than 15 minutes. The image disappears when you press **▶**. For the setup of “Screen Saver,” see page 25.
- The player goes to standby, 15 minutes after starting the screen saver function. Press **▶** to come out of standby mode.

To resume playback from the point where you stopped the disc (Resume Play) **DVDVideo** **DVDVR** **VCD** **CD**

When you press **▶** again after you stop playback, the player starts playback from the point when you pressed **■**.



- To play from the beginning of the disc, press **■** twice, and press **▶**.
- When turning power on again after power off, resume play starts automatically.



- Depending on the stop point, Resume play may not start from exactly the same point.
- The resume point is cleared when:
 - you turn off the player (including standby mode) for a DVD (VR mode).
 - you open the disc lid.
 - you press INPUT and switch the mode.

To play VIDEO CDs with PBC Functions (PBC Playback) **VCD**

PBC (Playback Control) allows you to play VIDEO CDs interactively using a menu. When you start playing a VIDEO CD with PBC functions, the menu appears. Select an item using the number buttons on the remote, and press ENTER. Then, follow the instructions in the menu (press **▶** when “Press SELECT.” appears).

About various playback operations

To	Operation
Change the LCD picture size	Press OPTIONS to select “LCD Mode” (page 17).
Display the DVD menu	Press MENU (page 5) or TOP MENU (page 7).
Check the DVD playback information	Press DISPLAY (page 14).
Play DVDs* ¹ repeatedly (Repeat Play)	Press DISPLAY to select “Repeat” (page 14).
Play DVDs in fast reverse or fast forward (Scan Play)	Press ◀/▶ repeatedly on the player to select the speed (page 5).
Switch between original and Playlist in DVD (VR mode)	Press TOP MENU repeatedly (page 7).
Check the CD or VIDEO CD playback information	Press DISPLAY (page 5).
Play CDs or VIDEO CDs* ² repeatedly (Repeat Play)	Press MENU repeatedly (page 5).
Play CDs or VIDEO CDs* ² randomly (Random Play)	Press MENU repeatedly (page 5).
Play CDs or VIDEO CDs in fast reverse or fast forward (Scan Play)	Press ◀/▶ repeatedly on the player to select the speed (page 5).

*¹ DVD VIDEO only

*² only when “PBC” is set to “Off.”

Using the Playback Information Display

DVDvideo DVDvr

While playing a DVD, you can check the current playback information. The playback information display also allows you to set a title/chapter or change sound/subtitle, and so on.

When entering the numbers, operate the number buttons on the remote.

1 Press DISPLAY while playing a DVD.

The current playback information appears.

Example: When playing a DVD VIDEO

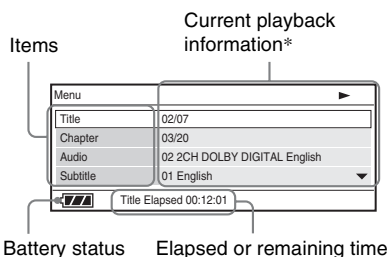

* When a DVD (VR mode) is played, “PL” (playlist) or “ORG” (original) is displayed next to the title number.

2 Press \uparrow/\downarrow to select items and press ENTER.

- Title: Select the title number by pressing \uparrow/\downarrow or number buttons.
- Chapter: Select the chapter number by pressing \uparrow/\downarrow or number buttons.
- Audio: Select the sound by pressing \uparrow/\downarrow .
- Subtitle: Select the subtitle by pressing \uparrow/\downarrow .
- Angle: Select the angle by pressing \uparrow/\downarrow .

- T.Time: Time appears while playing a title. “00:00:00” will appear by pressing ENTER. Enter the desired time code by pressing the number buttons.
- C.Time: Time appears while playing a chapter. “00:00:00” will appear by pressing ENTER. Enter the desired time code by pressing the number buttons.
- Repeat: Select “ \leftarrow Chapter,” “ \leftarrow Title,” “ \leftarrow All,” or “Off” by pressing \uparrow/\downarrow .
- Time Disp.: “Title Elapsed” is displayed. Select “Title Elapsed,” “Title Remain,” “Chapter Elapsed,” or “Chapter Remain” by pressing \uparrow/\downarrow .

3 Press ENTER.

To turn off the display

Press DISPLAY or RETURN.



Depending on the disc, you may not be able to set some items.

Playing MP3, JPEG, and Video Files **DATA**

You can play MP3, JPEG, and video files. For details on playable files, see “Playable Media” (page 34).

When you set a DATA media, a list of albums appears.

DATA CDs recorded in KODAK Picture CD format automatically start playing when inserted.

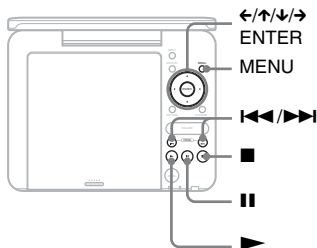

1 Press **↑/↓** to select the album, and press **ENTER**.

The list of files in the album appears. Example: The list of MP3 files

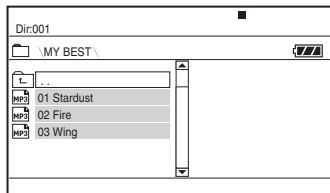

- To go to the next or previous page, press **▶▶** or **◀◀**.
- To return to the list of albums, press **↑/↓** to select **☐** and press **ENTER**.

2 Press **↑/↓** to select the file, and press **ENTER**.

Playback starts from the selected file.

To go to the next or previous file

Press **▶▶** or **◀◀**.

To stop playback

Press **■**.

The display will return to the list of files.

To pause playback (MP3 only)

Press **||**.

To restart playback, press **||** again.



If the number of viewing times is preset, you can play the DivX video files as many times as the preset number. The following occurrences will be counted as one time:

- when **■** is pressed.
- when the player is turned off (including standby mode).
- when the disc lid is opened.
- when another file is played.
- when INPUT is pressed and the mode is switched.
- when the USB device is disconnected.



Depending on the file, playback may take time to start or may not be able to start. For details on playable files, see “Playable Media” (page 34).

Selecting a JPEG file

To rotate a JPEG image

Press **←/↑/↓/→** while viewing the image file. Rotate every file.

→: Rotates the image 90 degrees clockwise.

←: Rotates the image 90 degrees counter clockwise.

↑: Reverses the image vertically (up and down).

↓: Reverses the image horizontally (left and right).

To display the list of thumbnails

Press MENU when an image file is displayed.

The image files in the album appear in 12 sub-screens with the displayed file in the lead.

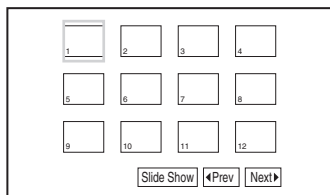

- To go to the previous or next list of thumbnails, select “◀Prev” or “Next▶” at the bottom of the screen, and press ENTER.
- To exit the list of thumbnails, press MENU.

Playing a Slide Show

- 1 While displaying the image file you want to start a slideshow, press MENU.**

The list of thumbnails appears.

- 2 Press ←/↑/↓/→ to select “Slide Show” at the bottom of the screen, and press ENTER.**

A slideshow starts from the displayed file.

To stop slideshow

Press ■ to return to the list of files.

Press MENU to return to the list of thumbnails.

To pause slideshow

Press ■.

Playing data on a USB device

You can play back DATA files on a USB device.

- 1 Press INPUT.**
- 2 Press ↑/↓ to select “USB” and press ENTER.**
- 3 Connect a USB device to the USB jack.**

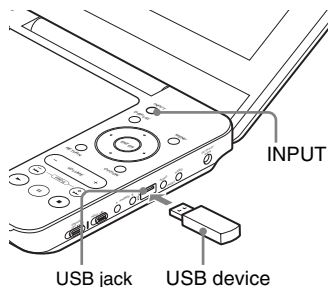

To disconnect a USB device

Make sure that the access indicator on the USB device is off, and disconnect the USB device.

About supported Sony USB devices

The following Sony USB Memory Stick reader/writer and USB flash drive “Micro Vault” are supported: MSAC-US40, USM-J series, USM-JX series, USM-J/B series, USM-L series, and USM-LX series.



- Do not disconnect the USB device while its access indicator is flashing. Doing so may cause data corruption or loss of data.
- USB devices which can connect to the player are flash memory and multiple card readers. Other devices (digital still camera, USB hub, etc.) cannot be connected. When an unsupported device is connected, an error message appears.

Adjusting the Picture Size and Quality

DVDVideo **DVDVR** **VCD** **DATA**

You can adjust the picture displayed on the LCD screen.

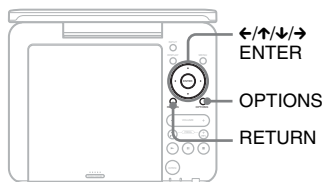

1 Press **OPTIONS**.

The menu display appears.

2 Press **↑/↓** to select “**LCD Mode**” and press **ENTER**.

The “LCD Mode” display appears.

items

LCD Mode	
LCD Aspect	Full
Backlight	10
Contrast	10
Hue	0
Color	10
Default	

3 Press **↑/↓** to select items and press **ENTER**.

- **LCD Aspect:** Change the picture size. Select “Normal” or “Full” by pressing **↑/↓***.
- **Backlight:** Adjust the brightness by pressing **←/→**.
- **Contrast:** Adjust the difference between light and dark areas by pressing **←/→**.

- Hue: Adjust the red and green colour balance by pressing ←/→.
- Color: Adjust the richness of colours by pressing ←/→.
- Default: Return all settings to the factory defaults.

4 Press ENTER.

* In “Normal,” pictures are displayed in their original configuration, retaining the aspect ratio. 4:3 pictures are displayed with black bands on both sides of the screen. 4:3 letter box pictures are displayed with bands on all sides of the screen.

In “Full,” pictures are adjusted to fill the entire screen. 16:9 pictures are displayed in their original configuration. (Black band recorded in a 16:9 picture cannot be erased.) 4:3 pictures appear stretched.

To turn off the menu display

Press OPTIONS or RETURN.



Depending on the disc, the screen size you can select differs.

Setting the channel

When you watch TV on the player for the first time, set the area and language.

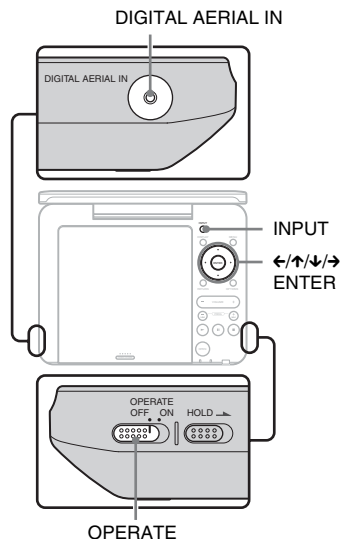

- 1 Connect the aerial cable to DIGITAL AERIAL IN on the player.**

The supplied aerial must be connected for outdoor use. Reception may vary depending on location.

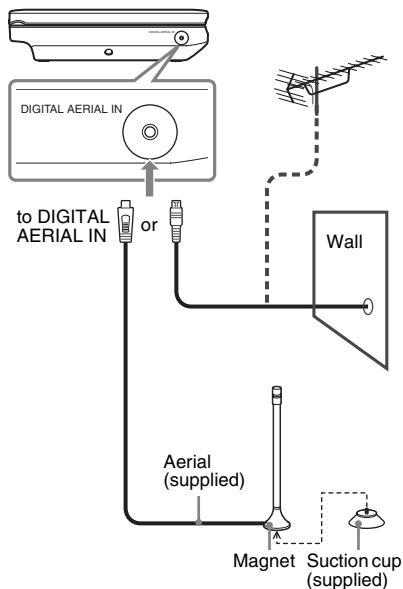

- 2 Slide the OPERATE switch to “ON.”**

- 3 Press INPUT.**

The Mode selection display appears.

- 4 Press \uparrow/\downarrow to select “TV” and press ENTER.**

The easy setup display appears.

- 5 Press \uparrow/\downarrow to select the language and press ENTER.**

The country selection display appears.

- 6 Press \uparrow/\downarrow to select the country and press ENTER.**

Channel scanning starts, and the received channels are registered in the Channel List.

Watching TV

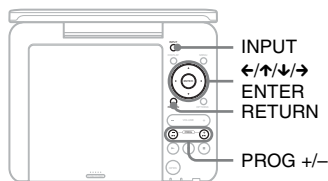

1 Press **INPUT**.

2 Press **↑/↓** to select “TV” and press **ENTER**.

The received channel is displayed.

3 Press **PROG +/-** to select a channel.



You can also select a channel by **↑/↓**.

To select a channel by Channel List or Favourite List

1 Press **ENTER** while watching TV.
The Channel List is displayed.

Channel List
001 BBC ONE
002 BBC TWO
003 BBC THREE
004 CBBC Channel
005 BBC NEWS 24 ▼

Pressing **←/→** while the Channel List is displayed switches to the Favourite List.

2 Press **↑/↓** to select the channel, and press **ENTER**.

To use a EPG

1 Press **GUIDE** while watching TV.
The EPG display of the current channel appears.

Guide	03/06/2009 18:20
▲	03/06/2009(Wednesday)
001 BBC ONE	18:00-18:30 The Daily News
002 BBC TWO	18:30-19:00 Word News and Sports
003 BBC THREE	19:00-19:30 Escape to the Country
004 CBBC Channel	19:30-20:00 Small Town
005 BBC NEWS 24	20:00-20:30 The Next Generation
105 BBC Red Button	20:30-21:00 BBC News
▼	21:00-21:50 The TV SHOW ▼
18:00-18:30	The Daily News

2 Press **↑/↓** to select a channel, and press **→**.

3 Press **↑/↓** to select a programme, and press **ENTER**.
The programme information, signal strength and signal quality are displayed.

To close the EPG screen

Press **GUIDE** or **RETURN**.

Using the TV Setup Display

- 1 Press **OPTIONS** while watching TV.

The option menu display appears.

- 2 Press **↑/↓** to select “TV Setup” and press **ENTER**.

- 3 Select and adjust each of the following items by pressing **↑/↓** and **ENTER**.

The remote is necessary for some settings.

To turn off the setup display

Press **OPTIONS** or **RETURN**.

Digital Channel List

◆ Channel Options

You can set a channel in the Channel List to be skipped, locked or deleted.

- Green button: Skip a channel. Pressing repeatedly toggles between skipping and not skipping.
- Yellow button: Lock a channel. The display for entering the password appears. Enter your DTV password (page 22). Pressing repeatedly toggles between locked and unlocked.
- Blue button: Delete a channel.

◆ Channel Sort

You can sort channels in the Channel List.

- 1 Press **↑/↓** to select “Channel Sort” and press **ENTER**.

- 2 Press **↑/↓** to select sorted channels and press **ENTER**.

The order of two selected channels changes places.

- 3 Repeat step 1 to sort other channels.

Tuning

◆ Replace Channels

You can replace the Channel List.

- 1 Press **↑/↓** to select “Replace Channels” and press **ENTER**.
- 2 Press **↑/↓** to select the country and press **ENTER**.
- 3 Press **←/→** to select “Yes” and press **ENTER**.

Channel scanning starts. The present Channel List is deleted, and the received channel is registered in the new Channel List.

◆ Add New Channels

You can add a new channel to the Channel List.

- 1 Press **↑/↓** to select “Add New Channels” and press **ENTER**.
- 2 Press **←/→** to select “Yes” and press **ENTER**.

Channel scanning starts. If a new channel is found, it is added to the Channel List.

◆ Manual Tuning

You can search for a channel manually and set to the Channel List.

- 1 Press **↑/↓** to select “Manual Tuning” and press **ENTER**.
- 2 Enter a frequency using the number buttons and press **↓**.
- 3 Press **→/↑/↓** to select a bandwidth and press **ENTER**.

- 4** Press ENTER to start channel scanning.
If a channel is received, it is added to the Channel List.



When you set “Tuning,” the “Digital Channel List” setting might be cleared. In this case, set again.

Features

◆ Language Setup

All default settings are “English.”

OSD	Switches the display language.
Primary Audio	Switches the language of the primary sound.
Secondary Audio	Switches the language of the secondary sound.
Subtitle	Switches the subtitle language.



If you select a language in a TV broadcast that is not included, a language included in TV broadcast will be automatically selected.

◆ Local Time Setting

Set the clock of the player.

GMT Offset	Selects the time according to the area. “Auto” (default) is generally used.
Summer Time	Sets Summer Time when selecting by “GMT Offset” excluding “Auto.” Select “On” or “Off” (default).

◆ TV Display

Set the aspect ratio of the connected TV. Select “4:3 Pan Scan,” “4:3 Letter Box” or “16:9” (default).

This setting is effective only in the TV mode.



When you watch TV on the LCD screen of this player, sets “LCD Aspect” of “LCD Mode” (page 17).

◆ Password/Lock

Sets the DTV password for limitation of digital TV programmes.

This setting is effective only in the TV mode.

- 1 Set “DTV Password.”
Enter a 4-digit number, using the number buttons on the remote.
- 2 Set a “DTV Age Limit.”
Select the limitation age.

If you forget your DTV password

Enter “1369” in “Old Password,” and enter your new password in “New Password” and “Verify Password.”

Factory Default

All functions returns to their original factory settings. Your DTV password is necessary for this setting (page 22). Note that all of your settings will be lost. When you perform this operation, the easy setup display appears (page 19).

Selecting by direct menu

You can select a function directly from the option menu display. You can operate the function without the remote control.

◆ Information

This option menu is the same function as the DISPLAY button.

◆ Guide

This option menu is the same function as the GUIDE button on the remote.

◆ TV Display

Sets the TV Display setting (page 22).

◆ Teletext

This option menu is the same function as the  button on the remote.

◆Subtitle

This option menu is the same function as the SUBTITLE button on the remote.

◆Audio

This option menu is the same function as the AUDIO button on the remote.

◆TV/Radio

This option menu is the same function as the TV/RADIO button on the remote.

Using the Setup Display

By using the setup display, you can make various settings to items such as picture and sound.

Some discs have stored playback settings, which take priority.

For TV setup, see “Using the TV Setup Display” (page 21).

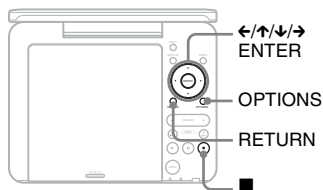

1 Press **OPTIONS** when the player is in stop mode.

The menu display appears. During Resume Play, you cannot use the setup display. Press **■** twice to clear Resume Play, and press **OPTIONS**.

2 Press **\uparrow/\downarrow** to select “Setup,” and press **ENTER**.

The setup display appears.

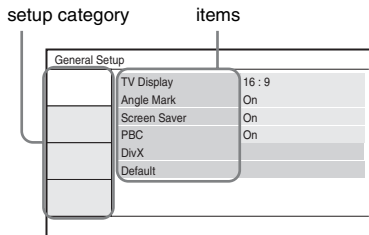

3 Press **\uparrow/\downarrow** to select the setup category and press **ENTER**.

- : General Setup (page 24)
Makes the player-related settings.
- : Audio Setup (page 25)
Makes the audio settings according to playback conditions.
- : Language Setup (page 26)
Makes the language settings for the on-screen display or sound track.
- : Parental Control (page 26)
Sets the parental control limit.

4 Select and adjust each of the following items by pressing **\uparrow/\downarrow** and **ENTER**.

To turn off the setup display

Press **OPTIONS** or **RETURN**.

General Setup

The default settings are underlined.

◆ **TV Display (DVD only)**

Selects the aspect ratio of the connected TV.

4:3 Pan Scan	Select this when you connect a 4:3 screen TV. Automatically displays a wide picture on the entire screen and cuts off the portions that do not fit.
4:3 Letter Box	Select this when you connect a 4:3 screen TV. Displays a wide picture with bands on the upper and lower portions of the screen.
<u>16:9</u>	Select this when you connect a wide-screen TV or a TV with a wide mode function.

4:3 Pan Scan



4:3 Letter Box



16:9



Depending on the disc, “4:3 Letter Box” may be selected automatically instead of “4:3 Pan Scan” or vice versa.

◆ Angle Mark (DVD VIDEO only)

Displays the angle mark when you can change the viewing angles during playback of DVDs recorded with multi-angles.

<u>On</u>	Display the angle mark.
Off	Hide the angle mark.

◆ Screen Saver

The screen saver image appears when you leave the player in pause or stop mode for 15 minutes. The screen saver will help prevent your display equipment from becoming damaged (ghosting). Press ► to turn off the screen saver.

<u>On</u>	Activates the screen saver function.
Off	Deactivates the screen saver function.

◆ PBC

You can enjoy playing interactive programmes using the PBC (Playback Control) function of a VIDEO CD if available (page 13).

<u>On</u>	By the PBC function, you can play back VIDEO CDs via the menu screen.
Off	Turn off the PBC function.

◆ DivX

Displays the registration code for the player. For more information, go to <http://www.divx.com> on the Internet.

◆ Default

Each function returns to its original factory settings. Note that all of your settings will be lost.

▶) Audio Setup

The default setting is underlined.

◆ Audio DRC (Dynamic Range Control) (DVD only)

Makes the sound clear when the volume is turned down when playing a DVD that conforms to “Audio DRC.”

<u>Standard</u>	Standard sound.
<u>TV Mode</u>	Makes low sounds clear even if you turn the volume down.
<u>Wide Range</u>	Gives you the feeling of being at a live performance.

A Language Setup

◆ OSD (On-Screen Display)

Switches the display language on the screen.

◆ Disc Menu (DVD VIDEO only)

Switches the language for the disc's menu. When you select "Original," the language given priority in the disc is selected.

◆ Subtitle (DVD VIDEO only)

Switches the subtitle language. When you select "Off," no subtitle is displayed.

◆ Audio (DVD VIDEO only)

Switches the language of the sound track. When you select "Original," the language given priority in the disc is selected.



If you select a language in "Disc Menu," "Subtitle," or "Audio" that is not recorded on the disc, one of the recorded languages will be automatically selected.

Parental Control

You can limit playback of a DVD that has the parental control function. When you operate this setting, use the remote.

◆ Password (DVD VIDEO only)

Enter or change a password. Set the password for the parental control function. Enter your 4-digit password using the number buttons on the remote.

To change the password

- 1 Press **↑/↓** to select "Password," and press **ENTER**.
- 2 Check "Change" is selected and press **ENTER**.
The display for entering the password appears.

Parental Control				
Old Password	<input type="text"/>	<input type="text"/>	<input type="text"/>	<input type="text"/>
New Password	<input type="text"/>	<input type="text"/>	<input type="text"/>	<input type="text"/>
Verify Password	<input type="text"/>	<input type="text"/>	<input type="text"/>	<input type="text"/>
<input type="button" value="OK"/>				

- 3 Enter your current password in "Old Password," your new password in "New Password" and "Verify Password," and press **ENTER**.

If you make a mistake entering your password

Press **CLEAR**, or press **←** to return one by one before pressing **ENTER** in step 3, and re-enter the password.

If you forget your password

Enter "1369" in "Old Password," and enter your new password in "New Password" and "Verify Password."

◆ Parental Control (DVD VIDEO only)

Set the limitation level. The lower the value, the stricter the limitation.

To set the parental control, you need to set the password first.

To set the parental control (limited playback)

- 1 Press **▲/▼** to select “Parental Control,” and press **ENTER**.
- 2 Press **▲/▼** to select the limitation level, and press **ENTER**. The lower the value, the stricter the limitation. The display for entering the password appears.

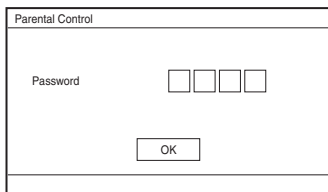

- 3 Enter your password, and press **ENTER**.

To play a disc for which Parental Control is set

Insert the disc and press **▶**, the display for entering your password appears. Enter your password using the number buttons on the remote, and press **ENTER**.



- When you play discs which do not have the Parental Control function, playback cannot be limited on the player.
- Depending on the disc, you may be asked to change the parental control level while playing the disc. In this case, enter your password, then change the level. If the Resume Play mode is cancelled, the level returns to the previous level.

Troubleshooting

If you experience any of the following difficulties while using the player, use this troubleshooting guide to help remedy the problem before requesting repairs. Should any problem persist, consult your nearest Sony dealer.

Power

The power is not turned on.

- ➔ Check that the AC power adaptor is connected securely (page 9).
- ➔ Check that the rechargeable battery is sufficiently charged (page 9).

The rechargeable battery cannot be charged.

- ➔ You cannot charge the rechargeable battery when power is turned on. Set the OPERATE switch to "OFF" (page 9).

Picture

There is no picture/picture noise appears.

- ➔ The disc is dirty or flawed (page 33).
- ➔ The brightness is set at minimum. Adjust the brightness of the LCD (page 17).
- ➔ When "USB" is displayed, press INPUT and select "Disc" (page 7).

The black points appear and the red, blue, green points remain on the LCD.

- ➔ This is a structural property of the LCD and not malfunction.

Sound

There is no sound.

- ➔ The player is in pause mode or in slow play mode.
- ➔ The player is in fast forward or fast reverse mode.

The sound volume is low.

- ➔ The sound volume is low on some DVDs. The sound volume may improve if you set "Audio DRC" in "Audio Setup" to "TV Mode" (page 25).

Operation

Nothing happens when buttons are pressed.

- ➔ The HOLD switch is set in the direction of the arrow (page 6).

The disc does not play.

- ➔ If the disc is turned over, a "No Disc" or "Cannot play this disc." message appears. Insert the disc with the playback side facing down (page 12).
- ➔ The disc is not set until it clicks (page 12).
- ➔ The disc that cannot be played is inserted. Check the region code matches the player, and that the disc has been finalised (page 34).
- ➔ When "USB" is displayed, press INPUT and select "Disc" (page 7).
- ➔ Parental Control has been set. Change the setting (page 26).
- ➔ Moisture has condensed inside the player (page 31).

The player starts and stops playing the disc automatically.

- ➔ The disc features an auto playback function.
- ➔ While playing discs with an auto pause signal, the player stops playback at the auto pause signal.

The disc does not start playing from the beginning.

- ➔ Repeat Play or Random Play is selected (page 13).
- ➔ Resume play has taken effect (page 13).
- ➔ The Playlist of the created disc is automatically played. To play original titles, press TOP MENU to set “Original” (page 7).

Playback may take time to start.

- ➔ Playback may take time to start in DVD (VR mode).

Playback freezes.

- ➔ When the playback layer of a DVD+R DL/-R DL disc changes, playback may freeze.

The subtitles disappear.

- ➔ When you change playback speed, or skip scenes during playback, the subtitles may disappear temporarily.

“⊙” or “△” appears and the player does not function according to the button pressed.

- ➔ Depending on the disc, you may not be able to perform certain operations. Refer to the operating instructions supplied with the disc.

“Copyright Lock” appears and the screen turns blue when playing a DVD (VR mode) disc.

- ➔ Images taken from digital broadcasts, etc., may contain copy protection signals, such as complete copy protection signals, single copy signals, and restriction-free signals. When images that contain copy protection signals are played, a blue screen may appear instead of the images. It may take a while when looking for playable images. (For player that cannot play images that contain a copy

protection only.)

◀/▶ does not work on menu display.

- ➔ Depending on the disc, you may not be able to use ◀/▶ on the player for the disc menu. In this case, use ◀/▶ on the remote.

The remote does not function.

- ➔ The battery in the remote is weak.
- ➔ There are obstacles between the remote and the player.
- ➔ The distance between the remote and the player is too far.
- ➔ The remote is not pointed at the remote sensor on the player.
- ➔ Direct sunlight or strong illumination is striking the remote sensor.
- ➔ When the AUDIO/SUBTITLE/ANGLE buttons do not work, select and operate it from the DVD menu.

The MP3, JPEG, or video file cannot be played (page 35).

- ➔ The file format does not conform.
- ➔ The extension does not conform.
- ➔ The file is damaged.
- ➔ The file size is too large.
- ➔ When the selected file is not supported, “Data Error” appears and the file will not be played.
- ➔ Because of the compression technology used for DivX/MPEG-4 video files, playback may take time to start.

The file or album names are not displayed correctly.

- ➔ The player can only display numbers and alphabet. Other characters are displayed as “*” (page 35).

The player does not operate properly or the power does not turn off.

- ➔ When static electricity, etc., causes the player to operate abnormally, set the OPERATE switch to “OFF” and press

ENTER on the player. If you perform this operation, some settings may return to their original factory settings.

Hookup

There is no picture or sound on the connected equipment.

- ➔ Re-connect the connecting cord securely (page 11).
- ➔ The connecting cord is damaged.
- ➔ Check the setting of a connected TV or amplifier.
- ➔ When “USB” is displayed, press INPUT and select “Disc” (page 7).

USB

The player does not recognize a USB device connected to the player.

- ➔ Re-connect the USB device securely (page 16).
- ➔ The USB device is damaged.
- ➔ Press INPUT to select “USB” (page 16).

TV

There is no picture for digital TV programmes.

- ➔ Re-connect the aerial cable securely.
- ➔ The connecting cable is damaged.
- ➔ Channel is used only for data (no picture or no sound).
- ➔ A scrambled channel is selected.
- ➔ Digital text service is not supported.

The channel is not found or stored or missed.

- ➔ Make sure that your aerial is properly connected to the player.
- ➔ Check your aerial installation.
- ➔ Data service is not supported.
- ➔ Inactive channels cannot be received.

The picture is breaking up.

- ➔ The signal strength is low.
- ➔ Check your aerial installation.

There is no picture using the supplied aerial.

- ➔ Check for reception strength.
- ➔ Adjust the direction of the aerial.
- ➔ Check that the region you are in has DVB-T broadcasts or not.
- ➔ In a DVB-T broadcast region reception may be difficult in the following places:
 - A heavily built up area
 - In an underground location, such as a subway or basement

Precautions

Road safety

Do not use the monitor unit and headphones while driving, cycling, or operating any motorized vehicle. Doing so may create a traffic hazard and is illegal in some areas. It can also be potentially dangerous to play your headsets at high volume while walking, especially at pedestrian crossings. You should exercise extreme caution or discontinue use in potentially hazardous situations.

On safety

Should any solid object or liquid fall into the cabinet, unplug the player and have it checked by qualified personnel before operating it any further.

On power sources

- If you are not going to use the player for a long time, be sure to disconnect the player from the wall outlet. To disconnect the AC power adaptor, grasp the plug itself; never pull the cord.
- Do not touch the AC power adaptor with wet hands. Doing so may cause shock hazard.
- Do not connect the AC power adaptor to a traveler's electric transformer, which may generate heat and cause a malfunction.

On temperature increases

- Heat may build up inside the player during charging or if it is being used for a long time. This is not a malfunction.
- Do not place the player directly on your lap. The temperature of the bottom of the player rises during normal operation. The heat can cause discomfort.

On placement

- Do not place the player in a confined space such as a bookshelf or similar unit.
- Do not cover the ventilation of the player with newspapers, tablecloths, curtains, etc. And do not place the player on a soft surface, such as a rug.
- Do not place the player and adaptors in a location near heat sources, or in a place subject to direct sunlight, excessive dust, sand, moisture, rain, or mechanical shock, or in a car with its windows closed.
- Do not place the player in an inclined position. It is designed to be operated in a horizontal position only.
- Keep the player and discs away from equipment with strong magnet, such as microwave ovens, or large loudspeakers.
- Do not drop or apply strong shock. Do not place heavy objects on the player and accessories.

On operation

- If the player is brought directly from a cold to a warm location, or is placed in a very damp room, moisture may condense on the lenses inside the player. Should this occur, the player may not operate properly. In this case, remove the disc and leave the player for about half an hour until the moisture evaporates. Wipe off moisture attached to the LCD surface with tissue etc. Turn on the power again later.
- Keep the lens on the player clean and do not touch it. Touching the lens may damage the lens and cause the player to malfunction. Leave the disc lid closed except when you insert or remove discs.
- Turn off the power before disconnecting the AC power adaptor, the car battery adaptor. Failure to do so may cause a malfunction.

On Liquid Crystal Display

- Although manufactured with high precision technology, the LCD may occasionally display dots of various colours. That is not a malfunction.
- Do not place or drop any object onto the LCD surface. Also, do not apply pressure from hands or elbows.
- Do not damage the LCD surface with a sharp edged tool.

On rechargeable battery

- Certain countries may regulate disposal of the battery used to power this product. Please consult with your local authority.
- Because of the battery's limited life, its capacity gradually deteriorates over time and repeated use. Exchange a new one when the battery holds about only half the normal period.
- The battery may not be charged to its fullest capacity when charged for the first time, or when it has not been used for a long time. The capacity recovers after being charged and discharged several times.

On AC power adaptor and car battery adaptor

- Use the supplied adaptors for the player, as other adaptors may cause a malfunction.
- Do not disassemble or reverse-engineer.
- Do not touch the metal parts, as it may cause a short and damage the adaptors, especially if touched by other metal objects.

On aerial

- The aerial must be connected for outdoor use. Use in all locations is not guaranteed.
- Do not connect the aerial to anything except the player.

On adjusting volume

Do not turn up the volume while listening to a section with very low level inputs or no audio signals. If you do, the speakers may be damaged when a peak level section is played.

On headphones

- Preventing hearing damage: Avoid using headphones at high volumes. Hearing experts advice against continuous, loud, and extended play. If you experience a ringing in your ears, reduce the volume or discontinue use.
- Showing consideration for others: Keep the volume at a moderate level. This will allow you to hear outside sounds and still be considerate to the people around you.

On cleaning

- Clean the cabinet, panel, and controls with a soft cloth slightly moistened with a mild detergent solution. Do not use any type of abrasive pad, scouring powder or solvent such as alcohol or benzine.
- Wipe the LCD surface with the soft dry cloth lightly. To prevent dirt buildup, wipe it frequently.
Do not wipe the LCD surface with a wet cloth. If water enters, a malfunction may result.
- If picture/sound is distorted, the lens may be covered with dust. In this case, use a commercially-available blower brush for camera lenses to clean the lens. Avoid touching the lens directly during cleaning.

On cleaning discs, disc/lens cleaners

Do not use cleaning discs or disc/lens cleaners (including wet or spray types). These may cause the apparatus to malfunction.

Notes About the Discs

- To keep the disc clean, handle the disc by its edge. Do not touch the surface.















- Do not expose the disc to direct sunlight or heat sources such as hot air ducts, or leave it in a car parked in direct sunlight as the temperature may rise considerably inside the car.
- After playing, store the disc in its case.
- Clean the disc with a cleaning cloth. Wipe the disc from the centre out.



- Do not use solvents such as benzene, thinner, disc/lens cleaners, or anti-static spray intended for vinyl LPs.
- If you have printed the disc's label, dry the label before playing.
- Do not use the following discs:
 - A disc that has a non-standard shape (e.g., card, heart).
 - A disc with a label or sticker on it.
 - A disc that has cellophane tape or sticker adhesive on it.

Playable Media

Type	Disc Logo	Icon	Characteristics
DVD	     <small>DVD+ReWritable DVD+R</small>  <small>DVD+R DL</small>		<ul style="list-style-type: none"> • Commercial DVD • DVD+RWs/DVD+Rs/ DVD+R DLs in +VR mode • DVD-RWs/DVD-Rs/ DVD-R DLs in video mode
			DVD-RWs/DVD-Rs/DVD-R DLs in VR (Video Recording) mode
CD			<ul style="list-style-type: none"> • Music CDs • CD-Rs/CD-RWs in music CD format
			<ul style="list-style-type: none"> • VIDEO CDs containing Super VCDs • CD-Rs/CD-RWs in video CD format or Super VCD format
DATA disc or USB	—		DATA CD/DATA DVD or USB devices containing MP3, JPEG, or video files.



• Notes about recordable media

Some recordable media cannot be played on the player due to the recording quality or physical condition of the media, or the characteristics of the recording device and authoring software.

The disc will not play if it has not been correctly finalised. For more information, refer to the operating instructions for the recording device. Note that some playback functions may not work with some DVD+RWs/+Rs/+R DLs, even if they have been correctly finalised. In this case, view the disc by normal playback.

• For player that cannot play images that contain a copy protection only

Images in DVD (VR mode) with CPRM* protection may not be played if they contain a copy protection signal. "Copyright Lock" appears.

* CPRM (Content Protection for Recordable Media) is a coding technology that protects the copyright of images.

Notes on MP3, JPEG, and video files

The player can play the following files:

- MP3 files with the extension “.mp3”^{*1}.
- JPEG files with the extension “.jpg”^{*2}.
- JPEG image files that conform to the DCF (Design rule for Camera File system) image file format.
- DivX video files with the extension “.avi” or “.divx.”
- MPEG-4 video files (simple profile) with the extension “.mp4”^{*3}.
- DATA CDs must be recorded according to ISO 9660 Level 1, or its extended format, Joliet.
- DATA DVDs must be recorded according to UDF (Universal Disk Format).

^{*1} Files in mp3PRO format cannot be played.

^{*2} Files with the extension “.jpe” or “.jpeg” can be played by changing the extension to “.jpg.”

^{*3} Files with copyright protection (Digital Right Management) cannot be played. Files in MPEG-4 AVC format cannot be played.



- To play a complex hierarchy of folders may take some time. Create albums as follows:
 - The number of hierarchies in the disc is no more than two.
 - The number of albums in the disc is 50 or less.
 - The number of files in one album is 100 or less.
- The player plays the file in an album in the order the media was recorded.



- The player will play any file in the above table, even if the file format differs. Playing such data may generate noise that can result in speaker damage.
- Some DATA discs created in Packet Write format cannot be played.
- Some DATA discs created in multiple sessions may not be playable.
- Some JPEG files cannot be played.

- The player cannot play the JPEG file that is larger than 3078 (width) x 2048 (height) in normal mode, or larger than 2000 (width) x 1200 (height) in progressive JPEG. (Some progressive JPEG files cannot be displayed even if the size is within this specified capacity.)
- The player may not play a combination of two or more DivX/MPEG-4 video files.
- The player cannot play a DivX/MPEG-4 video file of size more than 720 (width) x 576 (height)/2 GB.
- The player may not play certain DivX/MPEG-4 video files that are longer than 3 hours.
- Depending on the DivX/MPEG-4 video file, normal playback may not be possible. The picture may be unclear, playback may not appear smooth, the sound may skip, etc. You are recommended to create the file at a lower bit rate. If the sound is still noisy, check the audio format. (MP3 is recommended for DivX video files, and MPEG-4 video file should be AAC LC.) Note, however, the player does not conform to WMA (Windows Media Audio) format.
- The player may not playback the high bit rate video file on the DATA CD smoothly. You are recommended to playback using DATA DVD.
- The player can display a file or album name up to 14 characters. Special character appears as “*.”
- The player can display only the currently playing album name. Any album located on the upper layer is displayed as “\.\.”
- Playback information of some files may not be displayed correctly.

Notes on commercial discs

Region code

It is the system that is used to protect copyrights. The region code is shown on the DVD VIDEO packages according to the region of sale. DVD VIDEOS labelled “ALL” or “2” will play on the player.



DVD and VIDEO CD playback operations

Some playback operations of DVDs and VIDEO CDs may be intentionally set by software producers. Since the player plays DVDs and VIDEO CDs according to the disc contents the software producers designed, some playback features may not be available. Also, refer to the instructions supplied with the DVDs and VIDEO CDs.

Music discs encoded with copyright protection technologies

This product is designed to playback discs that conform to the Compact Disc (CD) standard.

Various music discs encoded with copyright protection technologies are marketed by some record companies. Please be aware that among those discs, there are some that do not conform to the CD standard and may not be playable by this product.

Audio material side of DualDiscs

A DualDisc is a two-sided disc product which mates DVD recorded material on one side with digital audio material on the other side.

However, since the audio material side does not conform to the Compact Disc (CD) standard, playback on this product is not guaranteed.

Specifications

System

Laser: Semiconductor laser
Signal format system: PAL (NTSC)
Transmission standards: DVB-T
Digital Channel coverage: VHF/UHF

Outputs

VIDEO (video output):

Minijack
Output 1.0 V_{p-p}/75 ohms

AUDIO (audio output)

Stereo minijack
Output 2.0 V_{rms}/47 kilohms
Recommended load impedance over 47 kilohms

PHONES (headphones) A/B:

Stereo minijack

USB:

USB jack Type A (For connecting USB memory)

DIGITAL AERIAL IN:

75 ohm external terminal for VHF/UHF

Liquid Crystal Display

Panel size: 7 inches wide (diagonal)
Driving system: TFT active matrix
Resolution: 480 × 234 (effective pixel rate: more than 99.99%)

General

Power requirements:

DC 9.5 V (AC power Adaptor/Car battery adaptor)
DC 7.4 V (rechargeable battery)

Power consumption (DVD VIDEO Playback):

7 W (when used with a headphone)

Dimensions (approx.):

200 × 39.5 × 155 mm (width/height/depth)
incl. projecting parts

Mass (approx.):

880 g

Operating temperature:

5 °C to 35 °C

Operating humidity:

25 % to 80 %

AC Power Adaptor:

110-240 V AC, 50/60 Hz

Car Battery Adaptor:

12 V DC

Supplied accessories

See page 9.

Specifications and design are subject to change without notice.

Index

Numerics

- 16:9 24
- 4:3 Letter Box 24
- 4:3 Pan Scan 24

A

- Angle Mark 8, 25
- Audio 8, 26
- Audio DRC 25
- Audio Setup 25

C

- CD 12, 34
- Channel 19
- Charging time and playing time 10

D

- DATA 15, 34
- DIGITAL AERIAL IN 19
- Disc Menu 26
- DivX (video file) 15, 35
- DVD 12, 34

G

- General Setup 24

J

- JPEG 15, 35

L

- Language Setup 26
- LCD Aspect 17
- LCD Mode 17

M

- MP3 15, 35
- MPEG-4 (video file) 15, 35

O

- OSD (On-Screen Display) 26

P

- Parental Control 26
- Password 26
- PBC 13, 25
- Playable Media 34
- Playback Information Display 14

R

- Random Play 13
- Region code 36
- Remote battery 9
- Repeat Play 13
- Resume Play 13

S

- Screen Saver 13, 25
- Setup 24
- Slide Show 16
- Subtitle 8, 22, 26

T

- Troubleshooting 28
- TV Display 24

U

- USB 16

V

- VIDEO CD 12, 34
- Video file (DivX/MPEG-4) 15, 35

4-126-491-12(1)



* 1 - 4 1 2 6 4 9 1 1 2 + *