

LCD Data Projector

Operating Instructions

VPL-FE110U
VPL-FE110M

WARNING

To prevent fire or shock hazard, do not expose the unit to rain or moisture.

To avoid electrical shock, do not open the cabinet. Refer servicing to qualified personnel only.

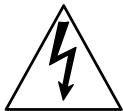
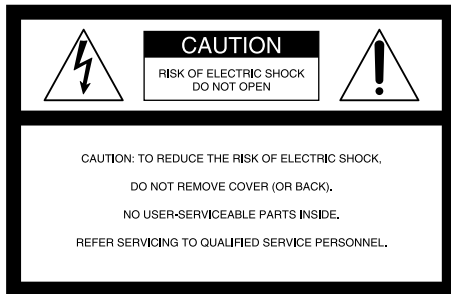

This symbol is intended to alert the user to the presence of uninsulated “dangerous voltage” within the product’s enclosure that may be of sufficient magnitude to constitute a risk of electric shock to persons.



This symbol is intended to alert the user to the presence of important operating and maintenance (servicing) instructions in the literature accompanying the appliance.

For the customers in the USA

This equipment has been tested and found to comply with the limits for a Class A digital device, pursuant to Part 15 of the FCC Rules. These limits are designed to provide reasonable protection against harmful interference when the equipment is operated in a commercial environment. This equipment generates, uses, and can radiate radio frequency energy and, if not installed and used in accordance with the instruction manual, may cause harmful interference to radio communications. Operation of this equipment in a residential area is likely to cause harmful interference in which case the user will be required to correct the interference at his own expense.

You are cautioned that any changes or modifications not expressly approved in this manual could void your authority to operate this equipment.

For the customers in Canada

This Class A digital apparatus complies with Canadian ICES-003.

For the customers in the United Kingdom

WARNING

THIS APPARATUS MUST BE EARTHED

IMPORTANT

The wires in this mains lead are coloured in accordance with the following code:

Green-and-yellow : Earth
Blue : Neutral
Brown : Live

As the colours of the wires in the mains lead of this apparatus may not correspond with the coloured markings identifying the terminals in your plug proceed as follows: The wire which is coloured green-and-yellow must be connected to the terminal in the plug which is marked by the letter E or by the safety earth symbol \perp or coloured green or green-and-yellow.

The wire which is coloured blue must be connected to the terminal which is marked with the letter N or coloured black. The wire which is coloured brown must be connected to the terminal which is marked with the letter L or coloured red.

Voor de klanten in Nederland

- Dit apparaat bevat een Li-ion batterij voor memory back-up.
- De batterij voor memory back-up van het geheugen is bevestigd op BT9001 van plaar QC.
- Raadpleeg uw leverancier over de verwijdering van de batterij op het moment dat u het apparaat bij einde levensduur afdankt.
- Bij dit produkt zijn batterijen geleverd. Wanneer deze leeg zijn, moet u ze niet weggooien maar inleveren als KCA.

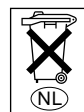

The socket-outlet should be installed near the equipment and be easily accessible.

AVERTISSEMENT

Afin d'éviter tout risque d'incendie et d'électrocution, ne pas exposer l'appareil à la pluie ou à l'humidité.

Pour éviter tout risque de décharge électrique, ne pas ouvrir le boîtier. Confiez l'entretien uniquement à un personnel qualifié.

Pour les utilisateurs au Canada

Cet appareil numérique de la classe A est conforme à la norme NMB-003 du Canada.

La prise doit être près de l'appareil et facile d'accès.

ADVERTENCIA

Para evitar riesgos de incendio o electrocución, no exponga la unidad a la lluvia ni a la humedad.

Para evitar recibir descargas eléctricas, no abra el aparato. Contrate exclusivamente los servicios de personal cualificado.

La toma mural debe estar instalada cerca del equipo y debe accederse a ésta con facilidad.

ACHTUNG

Um Feuergefahr und die Gefahr eines elektrischen Schlages zu vermeiden, darf das Gerät weder Regen noch Feuchtigkeit ausgesetzt werden.

Um einen elektrischen Schlag zu vermeiden, darf das Gehäuse nicht geöffnet werden. Überlassen Sie Wartungsarbeiten stets nur einem Fachmann.

Für Kunden in Deutschland

Dieses Produkt kann im kommerziellen und in begrenztem Maße auch im industriellen Bereich eingesetzt werden. Dies ist eine Einrichtung, welche die Funk-Entstörung nach Klasse B besitzt.

Entsorgungshinweis: Bitte werfen Sie nur entladene Batterien in die Sammelboxen beim Handel oder den Kommunen. Entladen sind Batterien in der Regel dann, wenn das Gerät abschaltet und signalisiert "Batterie leer" oder nach längerer Gebrauchsdauer der Batterien "nicht mehr einwandfrei funktioniert". Um sicherzugehen, kleben Sie die Batteriepole z.B. mit einem Klebestreifen ab oder geben Sie die Batterien einzeln in einen Plastikbeutel.

Die Steckdose muß nahe bei diesem Gerät angebracht und leicht zugänglich sein.

AVVERTENZA

Per evitare il pericolo di incendi o scosse elettriche, non esporre l'apparecchio alla pioggia o all'umidità e non aprirlo.

Per eventuali riparazioni, rivolgersi esclusivamente a personale qualificato.

La presa di corrente deve essere situata vicino all'apparecchio e deve essere facilmente accessibile.

Table of Contents

Overview

| | |
|--|----------|
| Precautions | 6 |
| Features | 7 |
| Location and Function of Controls | 8 |
| Front | 8 |
| Rear | 12 |
| Remote Commander | 14 |

Setting up and projecting

| | |
|--|-----------|
| Precautions on Installation | 17 |
| Installing the Projector on the Floor | 18 |
| Connecting to LAN | 19 |
| Connecting with a Computer or a VCR | 21 |
| Projecting | 22 |

Adjustments and settings using the menu

| | |
|-------------------------------------|-----------|
| Using the Menu | 25 |
| The PICTURE CTRL Menu | 26 |
| The INPUT SETTING Menu | 27 |
| The SET SETTING Menu | 30 |
| The SIGNAL SELECT Menu | 31 |

Connection examples/ Index number setting

| | |
|--|-----------|
| Connection Examples | 32 |
| Connecting 15k RGB/Component Equipment | 32 |
| Connecting the Switcher | 33 |
| Confirming the System Construction | 34 |
| Setting the Index Numbers | 35 |

Maintenance

| | |
|-------------------------------|-----------|
| Maintenance | 37 |
| Replacing the Lamp | 37 |
| Cleaning the Air Filter | 38 |
| Troubleshooting | 39 |

Others

| | |
|-----------------------------|-----------|
| Specifications | 42 |
| Index | 46 |

Precautions

On safety

- Check that the operating voltage of your unit is identical with the voltage of your local power supply. If voltage adaptation is required, consult with qualified Sony personnel.
- Should any liquid or solid object fall into the cabinet, unplug the unit and have it checked by qualified Sony personnel before operating it further.
- Unplug the unit from the wall outlet if it is not to be used for several days.
- To disconnect the cord, pull it out by the plug. Never pull the cord itself.
- The wall outlet should be near the unit and easily accessible.
- The unit is not disconnected from the AC power source (mains) as long as it is connected to the wall outlet, even if the unit itself has been turned off.
- Do not look into the lens while the lamp is on.
- Do not place your hand or objects near the ventilation holes — the air coming out is hot.

On installation

- When the projector is mounted on the ceiling, the Sony PSS-2000 Projector Suspension Support must be used for installation.
- Allow adequate air circulation to prevent internal heat build-up. Do not place the unit on surfaces (rugs, blankets, etc.) or near materials (curtains, draperies) that may block the ventilation holes. Leave space of more than 30 cm (11 ⁷/₈ inches) between the wall and the projector. Be aware that room heat rises to the ceiling; check that the temperature near the installation location is not excessive.
- Do not install the unit in a location near heat sources such as radiators or air ducts, or in a place subject to direct sunlight, excessive dust or humidity, mechanical vibration or shock.
- Do not install the projector near to medical instruments when a LAN card is used. It may cause incorrect operations of the instruments.

On illumination

- To obtain the best picture, the front of the screen should not be exposed to direct lighting or sunlight.
- Ceiling-mounted spot lighting is recommended. Use a cover over fluorescent lamps to avoid lowering the contrast ratio.

- Cover any windows that face the screen with opaque draperies.
- It is desirable to install the projector in a room where floor and walls are not of light-reflecting material. If the floor and walls are of reflecting material, it is recommended that the carpet and wall paper be changed to a dark color.

On preventing internal heat build-up

After turning off the power, the cooling fan runs for about six minutes while the ON indicator flashes in green. The indicator flashes quickly for one minute. During that time, you will not be able to turn the power back on with the ON key.

Caution

The projector is equipped with ventilation holes (intake) at the bottom/front side and ventilation holes (exhaust) at the left/right side. Do not block or place anything near these holes, or internal heat build-up may occur, causing picture degradation or damage to the projector.

On cleaning

- To keep the cabinet looking new, periodically clean it with a soft cloth. Stubborn stains may be removed with a cloth lightly dampened with a mild detergent solution. Never use strong solvents, such as thinner, benzene, or abrasive cleansers, since these will damage the cabinet.
- Avoid touching the lens. To remove dust on the lens, use a soft dry cloth. Do not use a damp cloth, detergent solution, or thinner.
- Clean the air filter in every 100 hours.

On repacking

Save the original shipping carton and packing material; they will come in handy if you ever have to ship your unit. For maximum protection, repack your unit as it was originally packed at the factory.

On LCD projector

LCD projector is manufactured using high-precision technology. You may, however, see tiny black points and/or bright points (red, blue, or green) that continuously appear on the LCD projector. This is a normal result of the manufacturing process and does not indicate a malfunction.

Features

High brightness, high picture quality

• High brightness

Adopting four newly developed 120 W UHP lamps and a LCD panel with micro lens provides high brightness (light output 4,000 of ANSI lumen) and excellent uniformity on the picture.

• High resolution

Thanks to use of three 1.8-inch SXGA¹⁾ panels with approximately 1,300,000 pixels, the projector can project the sharp picture with the resolution of 1280 × 1024 pixels.

• DRC (Digital Reality Creation)

The DRC technology allows you to obtain a finer, more detailed picture with four-times higher density than the conventional video picture.

Accepts various input signals

This projector has a built-in high performance scan converter which converts the input signals to display the 15 k RGB, DTV, HDTV, VGA¹⁾, SVGA¹⁾, XGA¹⁾, SXGA¹⁾ and UXGA¹⁾ (fV = up to 75 Hz) signals as well as the video signals of the composite, S video and component.

The projector accepts a wide range of HDTV/DTV signals as shown in the chart below.

| Format | Scanning rate (kHz) | Frame rate (Hz)* | Scanning format | Aspect ratio | Standard |
|------------|---------------------|------------------|-----------------|--------------|---------------------------|
| 1035/60i | 33.75 | 30 | 2:1 interlace | 16:9 | BTA S-001B |
| 1080/60i | 33.75 | 30 | 2:1 interlace | 16:9 | SMPTE 274M/ BTA S-001B |
| 480/60P | 31.5 | 60 | Progressive | 16:9/4:3 | SMPTE 293M |
| 575/50P | 31.25 | 50 | Progressive | 16:9/4:3 | – |
| 1080/24PsF | 27 | 24 | 2:1 interlace | 16:9 | – |
| 1080/50i | 28.13 | 25 | 2:1 interlace | 16:9 | SMPTE 274M |
| 720/60P | 45 | 60 | Progressive | 16:9 | SMPTE 293M |
| 720/50P | 37.5 | 60 | Progressive | 16:9 | – |

* Each of the frame rates is also compatible with 1/1.001.

System expandability and versatility

The projector has RS-232C/422A/PJ COM interface connectors for communication.

By combining the interface boards and signal interface switcher (not supplied), VPL-FE110U/FE110M projection systems can be greatly expanded. This projector also has the group and device index functions for using multiple projectors in one system.

Easy and flexible setup

• Easy setup with external equipment

This projector has 48 preset data for input signals in the memory. You can get a picture properly on the screen by connecting equipment and pressing Sony's original APA (Auto Pixel Alignment) key.

• Flexible setup

The lens shift function allows you to install the projector in a wide range of locations, without worrying about keystone distortion (the picture going out of square). The power focus and power zoom functions also let you change the size of the projection screen without having to move the projector.

• Stack installation

Thanks to the lens shift function, up to three projectors can be stacked, which improves the brightness of the image.

• Fail safe function

The projector uses four lamps for light source. Even if one of them has burnt out, you can still use the projector. If two lamps have burnt out, the projector will automatically enter into standby mode.

Selectable four lamps or two lamps

You can select four lamps for high brightness or two lamps for the long lamp lives. (For setting the lamp mode, consult with qualified Sony service personnel.)

Convenient network function

You can connect the projector to LAN using an optional LAN/wireless LAN PC card.

1) VGA, SVGA, XGA, SXGA and UXGA are the registered trademarks of the International Business Machines Corporation, U.S.A.

Location and Function of Controls

Front

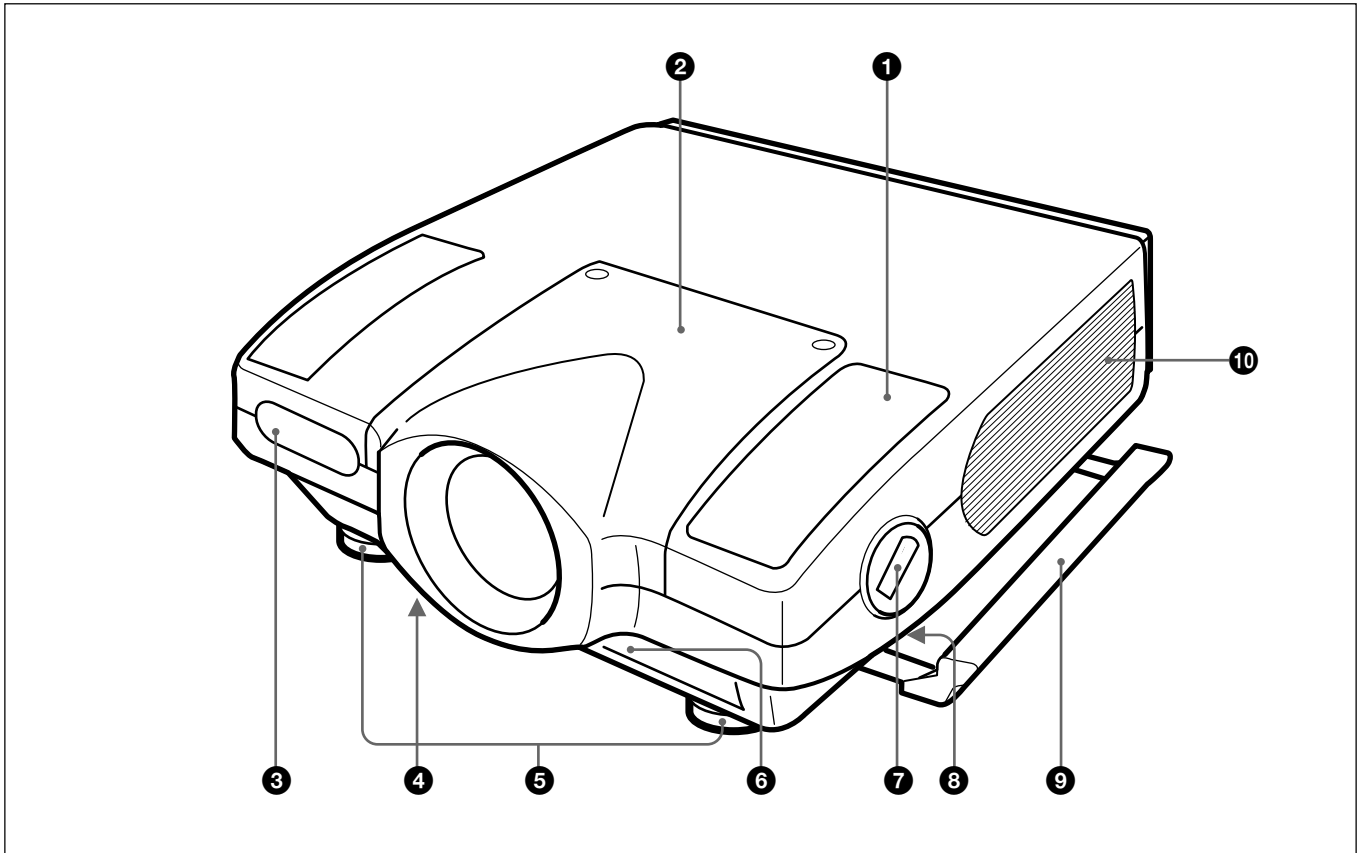

1 Speaker

2 Lens mount part

When attaching the optional lens, consult with the Sony service personnel.

3 Front remote control (SIRCS) detector

4 Bottom ventilation holes (intake)

Do not block the holes.

5 Adjusters

Use the adjusters to keep the projector level if it is installed on an uneven surface.

6 Front ventilation holes (intake)

Do not block the holes.

7 Adjuster button and lever

Press the button to raise the lever for adjusting the height of the adjuster.

8 Handle lever (left and right sides)

Use the lever for putting away the carrying handle.

9 Carrying handle (left and right sides)

Pull out the handle for carrying the projector.

10 Left and right side ventilation holes (exhaust)

Do not place anything within the 30 cm (11 ⁷/₈ inches) range from these holes or block them.

Notes

- Do not block the ventilation holes, or internal heat build-up may occur, causing fire or damage to the projector.
- Do not place anything near the ventilation holes or touch these holes as the temperature will be very high.

Using the carrying handles

Pull out to use for carrying the projector. To put away the handle, slide the handle lever forward.

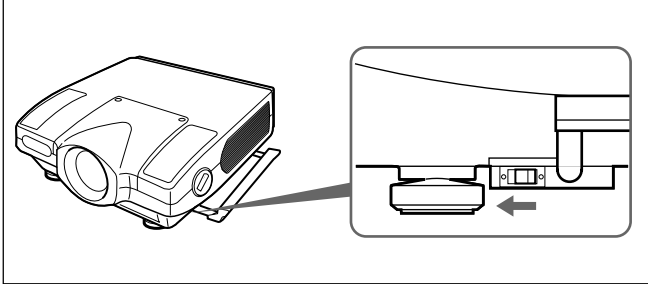

Using the adjusters

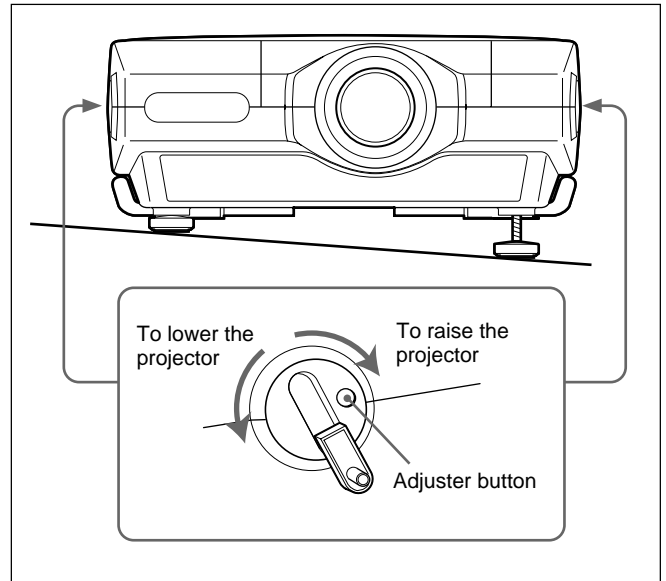

- 1** Press the adjuster button.
The adjuster lever comes out.
- 2** Turn the lever to adjust the height so that the projector becomes level.
- 3** Replace the adjuster lever after use.

Location and Function of Controls

Control panel

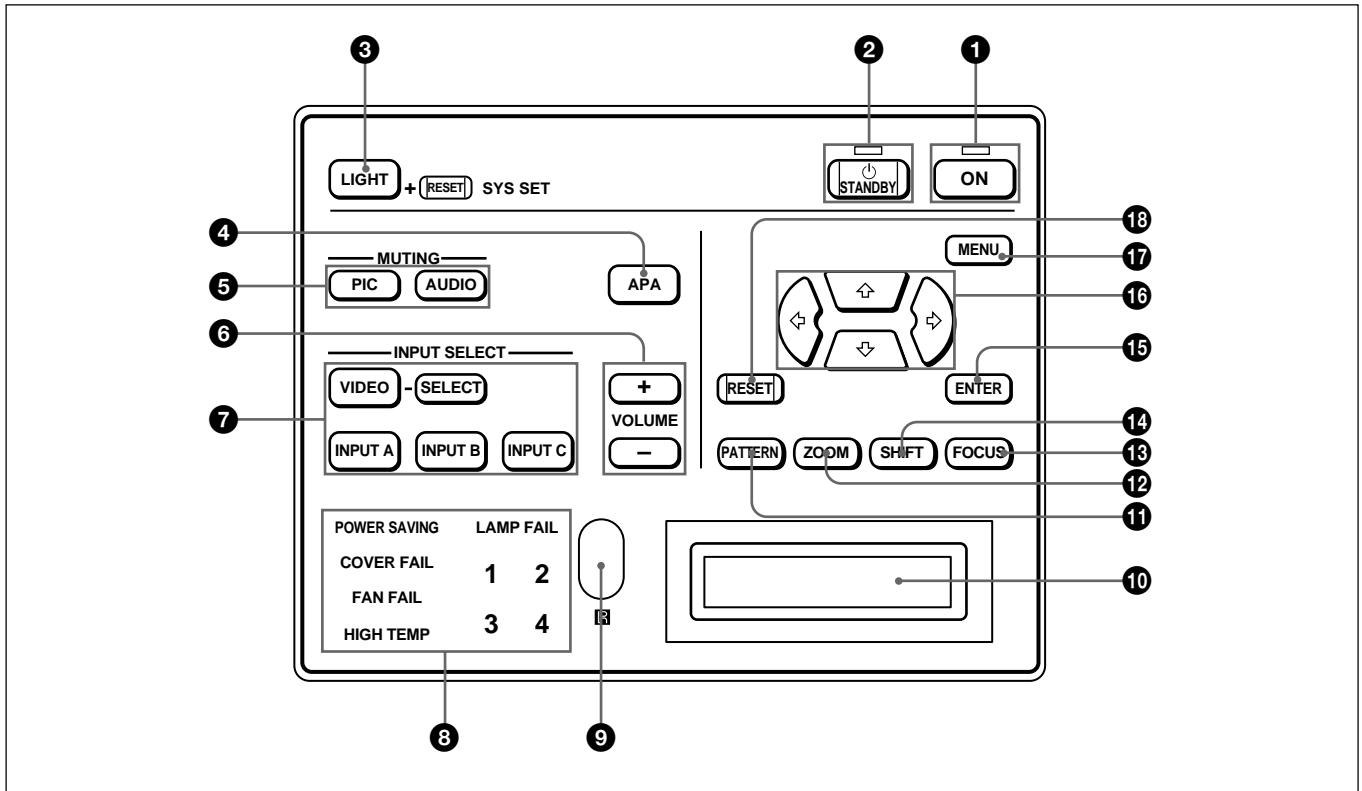

1 ON key and indicator

Press to turn on the power of the projector. The indicator lights when the key is pressed. The indicator flashes for about six minutes after the power is turned off by pressing the STANDBY key, as the fan runs for six minutes to cool down the inside of the projector. The indicator flashes quickly for one minute, during which you will not be able to turn the power back on with the ON key.

2 STANDBY key and indicator

Press to make the projector enter standby mode. The indicator lights to indicate that the projector is in standby mode.

3 LIGHT key

Illuminates the key indicators in orange when the projector is turned on. Illuminates the indicators for the relative keys in green when this key is pressed during operation. Press again to turn off the indicators.

Pressing this key and the RESET key simultaneously has the same function as the SYS SET key on the Remote Commander. Use when the PC-3000 signal interface switcher is used in the system or the system connections are changed.

4 APA (Auto Pixel Alignment) key

Adjusts the position of the picture on the screen automatically so that the picture is clearly visible when the signals are input from a computer.

5 MUTING keys

Cut off the picture or sound temporarily.

PIC: Press to cut off the picture. Press again to restore the picture.

AUDIO: Press to cut off the sound output from the speakers or the AUDIO OUT jacks. Press again or press the VOLUME + key to restore the sound.

6 VOLUME +/- keys

Adjust the volume of the built-in speakers and output level of the AUDIO OUT jacks.

+ : Increases the volume.

- : Decreases the volume.

7 INPUT SELECT keys

Select the input signal.

VIDEO: Selects the video signal input from the VIDEO or S VIDEO connectors and the audio signal input from the AUDIO IN L/R jacks. To switch the S VIDEO and VIDEO connectors, use the SELECT key.

SELECT: Each time you press this key, the input video signal is switched between the VIDEO and S VIDEO connectors.

INPUT A: Selects the audio and video signals input from the INPUT A connectors.

INPUT B: Selects the signal input from the connectors on the optional interface board which is installed in the INPUT B section. When the IFB-12A interface board is installed and the output mode is selected on the IFB-12A, the key does not function.

INPUT C: Selects the Windows CE.

Note

When the INPUT C/RS-232C/RS-422A select switch is not set to INPUT C, the image from the INPUT C slot does not appear.

8 Indicators

POWER SAVING: Lights when the projector is in power saving mode. When POWER SAVING in the SET SETTING menu is set to ON, the projector goes into the power saving mode if no signal is input for 10 minutes. Although the lamp goes out, the cooling fan keeps running. In the power saving mode, only the STANDBY key functions for the first 60 seconds. The power saving mode is canceled when a signal is input or any key is pressed.

COVER FAIL: Lights when the lamp cover or air filter cover is not secured firmly.

FAN FAIL: Lights when the fan is broken.

HIGH TEMP: Lights when temperature inside the projector becomes unusually high.

LAMP FAIL: When the lamp life has reached the end, the indicator of that lamp lights.

9 Rear remote control (SIRCS) detector

10 Message display window

Displays the signal status, timer and error messages about the input signals.

11 PATTERN key

Displays a HATCH pattern on the screen for focus, zoom, and shift adjustments. Press again to turn off the HATCH pattern.

12 ZOOM key

Enters the zoom adjustment mode. When the key is pressed, the relative keys light in green.

Next adjust the zoom using the arrow keys.

↑, →: Enlarges the picture size.

↓, ←: Reduces the picture size.

Note

If the VPLL-2075, VPLL-2014, VPLL-2009 or VPLL-3050 optional lens is installed, you cannot adjust the zoom.

13 FOCUS key

Enters the focus adjustment mode. When the key is pressed, the relative keys light in green.

Next adjust the focus using the arrow keys.

↑, →: Focuses on a forward picture.

↓, ←: Focuses on a picture further back.

14 SHIFT (lens shift) key

Enters the shift adjustment mode. When the key is pressed, the relative keys light in green.

Next adjust the vertical position of the picture using the arrow keys.

↑, →: Moves the picture upward.

↓, ←: Moves the picture downward.

15 ENTER key

Stores the settings in the menu.

16 Arrow keys (↑/↓/←/→)

Used to adjust the picture after pressing the ZOOM, FOCUS or SHIFT key. Also used to move the cursor or adjust the value in the menu.

17 MENU key

Displays the menu on the screen. When the key is pressed, the relative keys light in green.

Press again to turn off the menu.

18 RESET key

Resets the adjusted value of an item to its factory preset value. This key functions when the menu or a setting item is displayed on the screen.

Location and Function of Controls

Rear

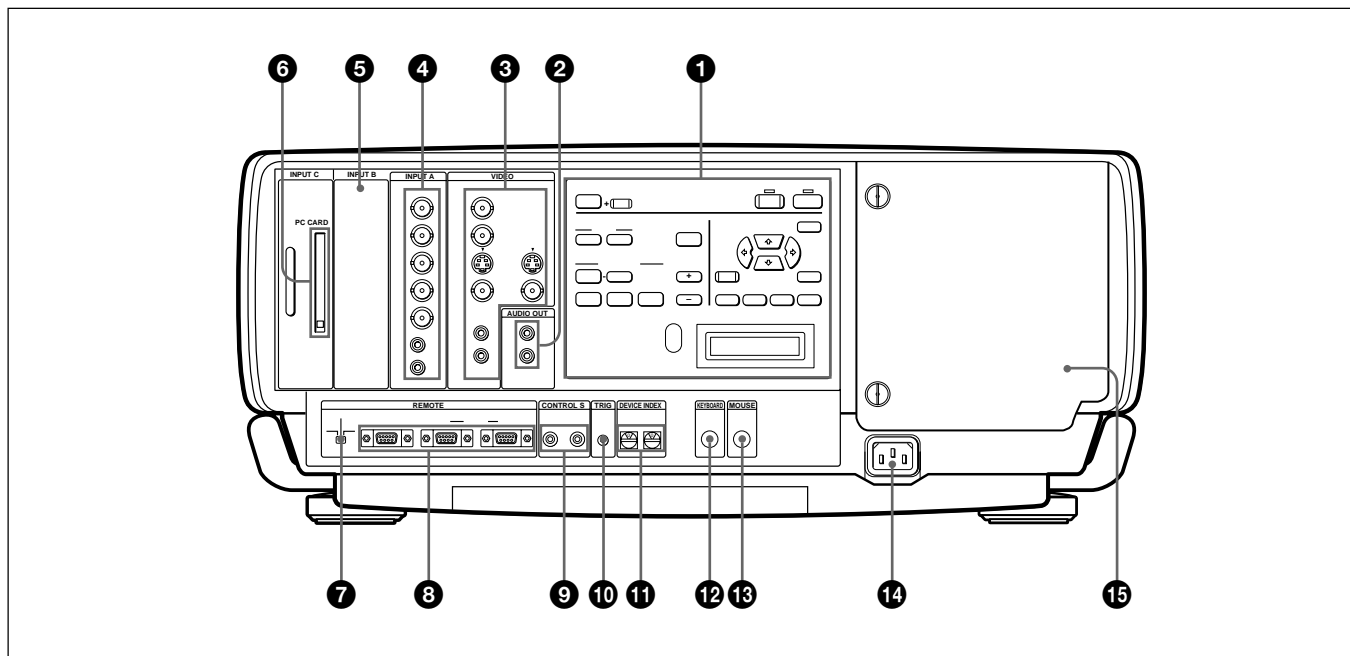

1 Control panel

For details, see pages 10 and 11.

2 AUDIO OUT L/R jacks (phono type)

Connect to external active speakers.

The volume of the speakers can be controlled by the VOLUME keys on the Remote Commander or the control panel.

3 VIDEO connectors

Connect to external video equipment, such as a VCR.

Y IN/C IN (BNC type): Connect to the Y and C video outputs of the video equipment.

S VIDEO IN (mini DIN 4-pin): Connects to the Y/C video output of the video equipment.

S VIDEO OUT (mini DIN 4-pin): Used as loop-through output via the Y/C IN connectors or the S VIDEO IN connector.

VIDEO IN (BNC type): Connects to the composite video output connector of the video equipment.

VIDEO OUT (BNC type): Used as loop-through output of the VIDEO IN connector.

AUDIO IN L (MONO)/R jacks (phono type):

Connect to the audio output jacks of equipment, such as a VCR. For stereo equipment, use both the L and R jacks; for monaural equipment, use the L (MONO) jack only.

Note

If you have video equipment connected to both the Y/C IN and S VIDEO IN connectors, the signal from the Y/C IN connectors are selected prior to the S VIDEO IN connector. When projecting video connected to the S VIDEO IN connector, be sure not to connect any cable to the Y/C IN connectors.

4 INPUT A connectors

RGB input connectors (R/R-Y/P_R, G/Y, B/B-Y/P_B, SYNC/HD, VD) (BNC type): Connect to the video outputs of equipment such as a computer or a video camera.

According to the connected equipment, the RGB, component (R-Y, Y, B-Y), HDTV (Y_PB_PR or GBR) or DTV (Y_PB_PR or GBR) signal is selected.

AUDIO IN L (MONO)/R jacks (phono type):

Connect to the audio output jacks of equipment such as a computer or a video camera. For stereo equipment, use both the L and R jacks; for monaural equipment, use the L (MONO) jack only.

Note

The INPUT A connectors do not function when the PC-3000 signal interface switcher is connected.

5 Signal interface board attachment part (INPUT B)

Optional signal interface board can be attached according to your requirements. If you install the IFB-12A interface board to this section and select the output mode, you can output the signal input through the INPUT A connectors.

For details on installing the interface boards, consult with qualified Sony personnel.

6 PC card slot (INPUT C)(Type II)

The recommended LAN PC card or memory card can be attached according to your requirements. For details, please read the attached "Operating Instructions for Networking."

Note

You cannot output the signal input through the INPUT C from the INPUT B connectors (even when the IFB-12A interface board is installed to INPUT B.)

7 INPUT C/RS-232C/RS-422A select switch

Selects according to the interface connected to the INPUT C or RS-232C/RS-422A connector.

8 REMOTE connectors

Used to expand system capability.

RS-232C/RS-422A connector (D-sub 9-pin, female): Connect to a computer to operate the projector from the computer.

PJ COM IN/OUT connectors (D-sub 9-pin, female): The connectors conform to the RS-485 standards and are used to expand system capability for Sony projectors.

For details on connections, see the PJ COM protocol manual for Sony projectors.

Note

When the INPUT C/RS-232C/RS-422A select switch is set to INPUT C, you cannot use the PJ COM IN/OUT connectors.

9 CONTROL S IN/OUT jacks (stereo minijack)

Connect to the control S jacks of other Sony equipment.

CONTROL S IN/PLUG IN POWER (DC 5 V output) jack: Connects to the CONTROL S OUT jack of the supplied Remote Commander when using as a wired Remote Commander. In this case, you do not need to install the batteries in the Remote Commander, since the power is supplied from this jack.

CONTROL S OUT jack: Outputs the control S signal.

Note

When connecting the remote commander cable to the CONTROL S IN jack, the remote control detectors will not function.

10 TRIG (trigger output) jack (monaural minijack)

The signal is transmitted from this jack to the connected equipment whether the projector is on or off. (This is not a power source for external equipment.) Approximately 12 V DC signal is output when the projector power is on. The signal is 0 volt level output when the projector power is off.

11 DEVICE INDEX switch

Set the device index number of the projector when using multiple projectors. You can set the numbers between "01" and "99". It is set to "01" at the factory. You can also set the group index number in the menu for system setup.

Note

Do not set the device index number to "00". If you do, the projector will be operated only with the keys on the control panel.

12 KEYBOARD connector (PS/2, mini DIN 6-pin)

Connect a keyboard. This connector functions when the INPUT C/RS-232C/RS-422A select switch is set to INPUT C and the INPUT C signal is selected.

Note

Connect the keyboard before the power of the projector is turned on.

13 MOUSE connector (PS/2, mini DIN 6-pin)

Connect a mouse. This connector functions when the INPUT C/RS-232C/RS-422A select switch is set to INPUT C and the INPUT C signal is selected.

Note

Connect the mouse before the power of the projector is turned on.

14 AC IN socket

Connect the supplied AC Power cord.

15 Lamp cover

Location and Function of Controls

Remote Commander

The Remote Commander can be used as a wireless or wired Remote Commander. The keys on the Remote Commander with the same names function the same as those on the control panel of the projector. For details on control panel keys on the projector, see pages 10 and 11.

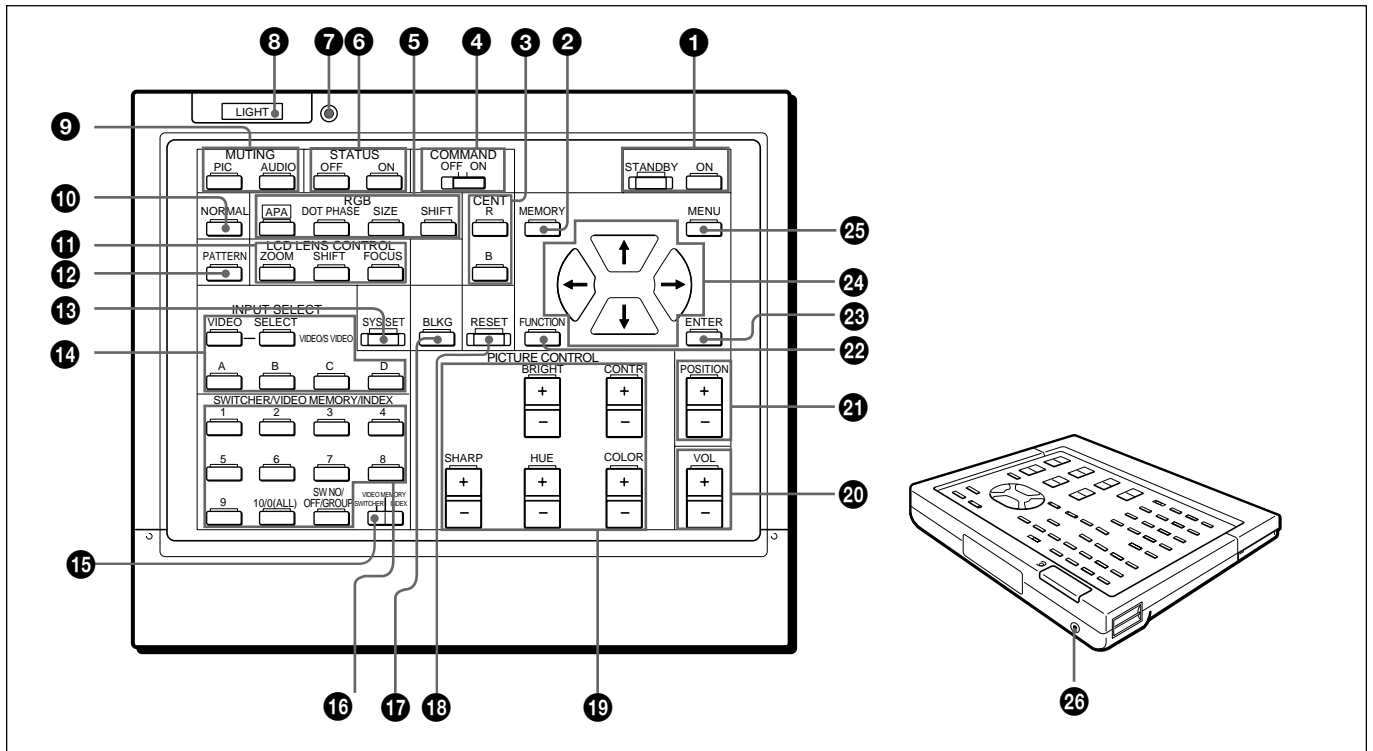

1 ON/STANDBY keys

2 MEMORY key

This key does not function with this projector.

3 CENT R/B keys

The keys do not function with this projector.

4 COMMAND ON/OFF key

No keys except for the LIGHT button on the Remote Commander function when this switch is set to OFF. This saves battery power.

5 RGB keys

Adjust the picture.

APA: The key functions the same as the APA key on the control panel.

DOT PHASE: Press to adjust the phase of the LCD panels and the input signals (except for 15k RGB/video/HDTV/DTV signals). After pressing this key, adjust the position of the picture using the

four arrow keys so that the clearest picture is obtained.

SIZE: Enters the size adjustment mode for the input signal. Next adjust the horizontal size of the picture using the arrow keys.

◀: to reduce horizontal size

▶: to expand horizontal size

SHIFT: Enters the shift adjustment mode for the input signal. Next adjust the position of the picture using the four arrow keys. The picture shifts in the direction of the arrow on the pressed key.

6 STATUS ON/OFF keys

Press OFF to eliminate the on-screen display. Press ON to restore the on-screen display.

Note

The menus and warning messages appear even if the OFF key is pressed.

7 Transmission indicator

The light goes on each time a key is pressed. If the indicator does not light, replace the batteries.

8 LIGHT button

Illuminates the key indicators when the COMMAND switch is set to ON. If the switch is set to OFF, only the COMMAND switch is illuminated.

If you do not press any key on the Commander for more than 30 seconds, the key indicators turn off automatically. The indicators also turn off if you press the LIGHT button again.

9 MUTING keys

10 NORMAL key

The key does not function with this projector.

11 LCD LENS CONTROL keys

Press one of the ZOOM, SHIFT and FOCUS keys and then the arrow keys (▲ or ▼).

12 PATTERN key

13 SYS SET (system set) key

When the PC-3000 signal interface switcher is used in the system or the system connections are changed, press this key.

Note

After connecting the PC-3000 switcher and pressing the SYS SET key, the input channel is set to SW1-1 when connecting a single switcher, or to SW1-2 when connecting two or more switchers.

14 INPUT SELECT keys

The D key does not function with this projector.

15 SWITCHER/VIDEO MEMORY/INDEX select switch

Selects the function of the SWITCHER/VIDEO MEMORY/INDEX keys.

SWITCHER: selects the input from the PC-3000 switcher.

VIDEO MEMORY: The position does not function with this projector.

INDEX: selects a projector by its index number when multiple projectors are used.

16 SWITCHER/VIDEO MEMORY/INDEX keys

When the SWITCHER/VIDEO MEMORY/INDEX select switch is set to SWITCHER

When the PC-3000 switcher is connected to the projector, press a number key (1 to 8) to select the input from the switcher. Number key 9 does not function.

To select an input when multiple switchers are connected, press the SW NO/OFF/GROUP key. Next press the switcher number (1 to 8) and the input number (1 to 8) in sequence. Be sure to press the keys one after another within 2 seconds.

e.g. To select input 4 of switcher 2, press the keys as follows: SW NO → 2 → 4.

When the SWITCHER/VIDEO MEMORY/INDEX select switch is set to INDEX

Used to specify the device or group index number.

17 BLKG (blanking) adjustment key

Enters the blanking adjustment mode.

Next, press the ▲/▼ key to select the position to be adjusted on the screen, and then adjust the position using the ◀/▶ keys.

18 RESET key

Press the FUNCTION key and then RESET key on the Remote Commander within 5 seconds to reset the Windows CE.

19 PICTURE CONTROL +/- keys

Adjust the picture conditions: CONTR (contrast), BRIGHT (brightness), COLOR, HUE and SHARP (sharpness).

20 VOL (volume) +/- keys

21 POSITION +/- keys

These keys do not function with this projector.

22 FUNCTION key

Press the FUNCTION key and then RESET key on the Remote Commander within 5 seconds to reset the Windows CE.

(continued)

Location and Function of Controls

23 ENTER key

24 Arrow keys

25 MENU key

26 CONTROL S OUT jack

Connect the supplied remote control cable to this jack and to the CONTROL S IN jack of the projector for wired remote control operation.

When the Commander is connected to the CONTROL S IN/PLUG IN POWER jack of the projector via the remote control cable (stereo), the power for the Remote Commander is supplied from the projector.

Battery installation

1 Push to open the lid.

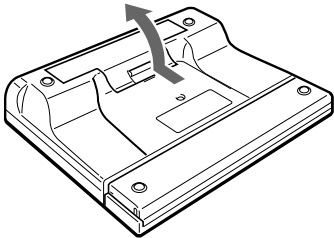

2 Install three R6 (size AA) batteries (supplied) with the polarities correctly aligned.

Be sure to install the battery from the ⊖ side.

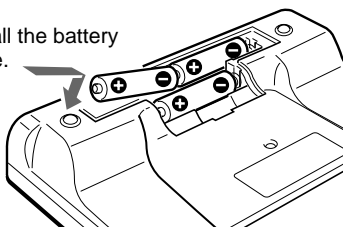

3 Replace the lid.

Notes on batteries

- Make sure that the battery orientation is correct when inserting batteries.
- Do not mix old battery with new one, or different types of batteries.
- If you will not use the Remote Commander for a long time, remove the batteries to avoid damage from battery leakage. If batteries have leaked, remove them, wipe the battery compartment dry and replace the batteries with new ones.

Notes on wireless Remote Commander operation

- Be sure that there is nothing to obstruct the infrared beam between the Remote Commander and the projector.
- The operation range is limited. The shorter the distance between the Remote Commander and the projector, the wider the angle within which the commander can control the projector.
- The remote control detectors on the projector do not operate when connecting the remote commander cable to the CONTROL S IN jack. If you wish to use the Remote Commander as a wireless Remote Commander, be sure to remove the remote commander cable from both the Remote Commander and the projector.

To connect the Remote Commander to the projector

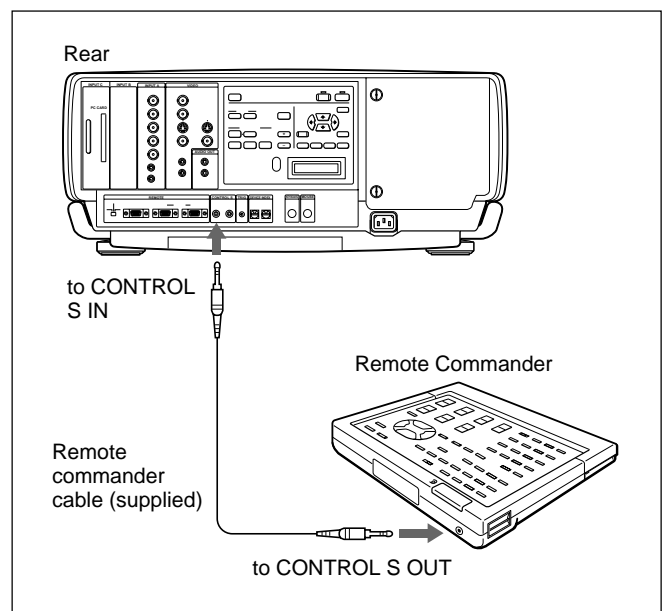

Note on wired Remote Commander operation using the supplied remote commander cable (stereo)

You do not need to install the batteries since the power is supplied from the CONTROL S IN jack on the projector. In this case, the batteries are not consumed.

Precautions on Installation

Do not install the projector in the following situations. These installations may cause malfunction or damage to the projector.

Do not install the projector in an ill-ventilated place

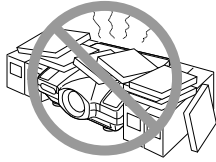

The projector is equipped with ventilation holes for intake on the bottom and front and ventilation holes for exhaust on the left and right sides to prevent internal heat build-up. Do not block these ventilation holes and allow adequate air circulation at an installation location.

Do not place any object beside the projector

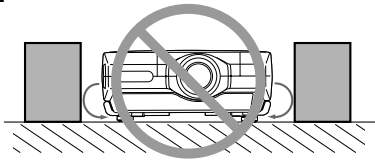

If you put something beside the ventilation holes on the sides, the exhaust may be inhaled into the projector through the ventilation holes (intake) at the bottom, causing the internal temperature to rise and thereby activating the protection circuit. Install the projector so that the exhaust is not blocked.

Do not install the projector in a location where temperature or humidity is very high

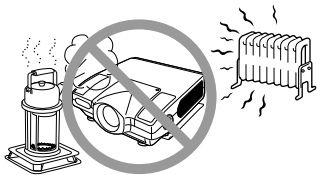

Avoid installing the projector in a location where temperature may rise or fall rapidly

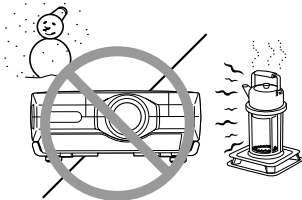

Be careful of air-conditioning and heating in a room where the projector is installed, as sudden changes in temperature may lead to moisture condensation and cause damage to the projector.

Avoid installing the projector in a location subject to excessive dust



Do not cover the ventilation holes (exhaust)



Do not cover the front ventilation holes; otherwise, internal heat may build up.

Do not install the projector on a deep-pile carpet

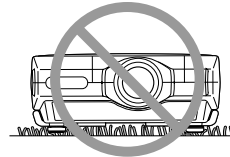

If you install the projector on a deep-pile carpet, the ventilation holes (intake) at the bottom may be blocked, causing an internal heat build-up.

Do not tilt the projector more than 20 degrees

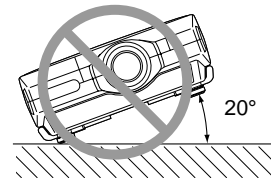

Avoid tilting the projector side to side more than 20 degrees or installing it other than on the floor or ceiling. Such installations may cause malfunctions such as color irregularity or shortening of lamp life.

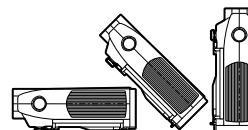

The front to back tilt angle of this projector is not limited.

Installing the Projector on the Floor

This section describes the installation arrangements for installing the projector on the floor.

For ceiling installation, consult with qualified Sony personnel.

For details on installation examples with projection distances, see the supplied "Projection Distance Charts."

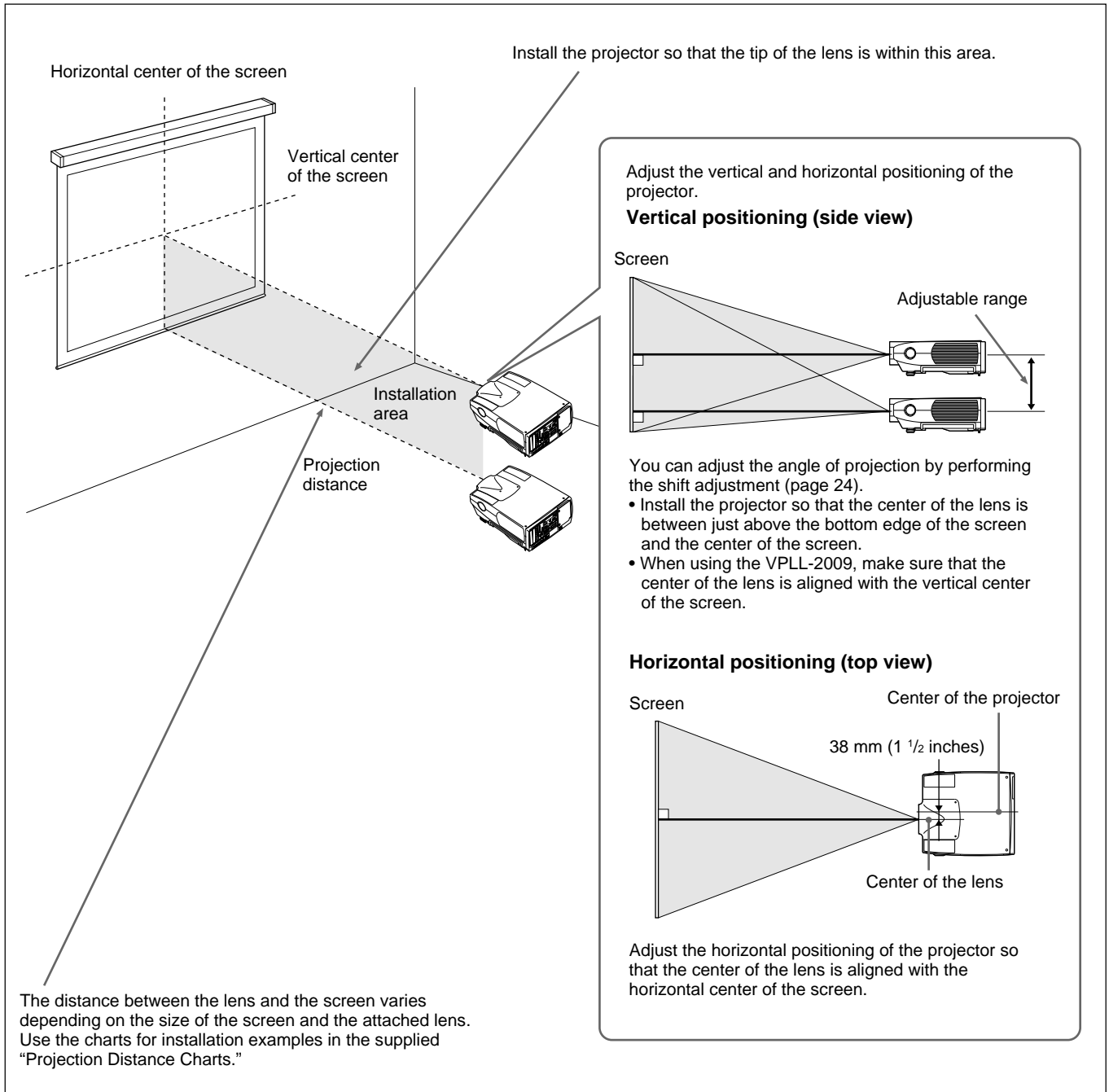

Connecting to LAN

This section describes how to connect the LAN PC card or wireless LAN PC card and install the memory card. For details on how to connect other equipment, see pages 21 and 32 to 34. Also refer to the instruction manuals of the equipment to be connected.

Installing a PC card

When you use the LAN PC card, wireless LAN PC card or memory card, insert the card into the PC card slot of INPUT C of the projector and set the INPUT C/RS-232C/RS-422A select switch to INPUT C.

When the PC card is inserted into the slot, the eject button pops out.

To remove the PC card from the slot, press the eject button.

Notes

- For details of the recommended PC card or wireless LAN access point, see the attached “Recommended PC card/wireless LAN access point.”
- When you use LAN, you must set the IP address. For details of setting IP address, etc., see the attached “Operating Instructions for Networking.”

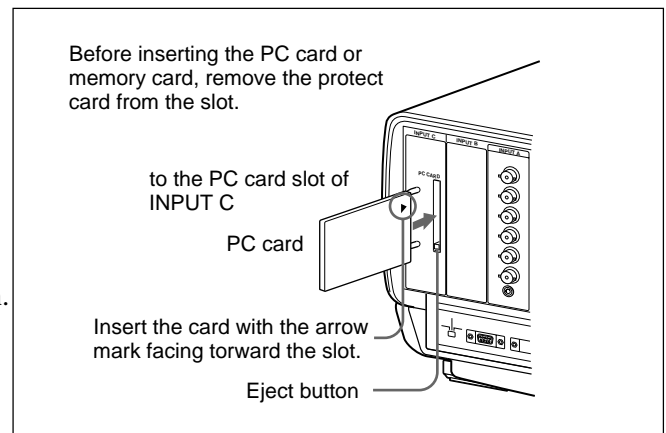

Connection of LAN PC card

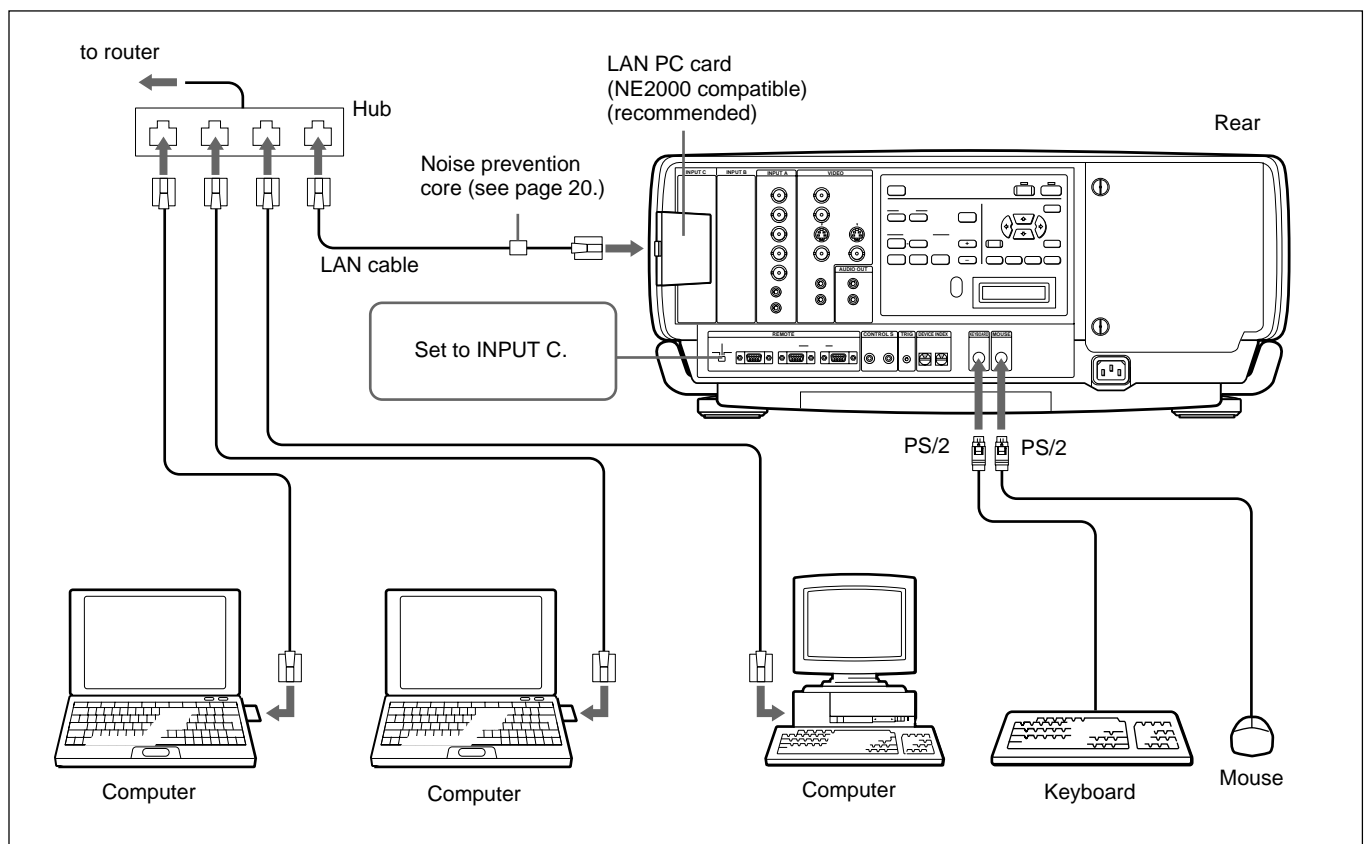

Connecting to LAN

When connecting the projector to LAN

Attach the supplied noise prevention core near to the projector of the LAN cable.

When the shielded LAN cable is used, you do not need to attach the noise prevention core.

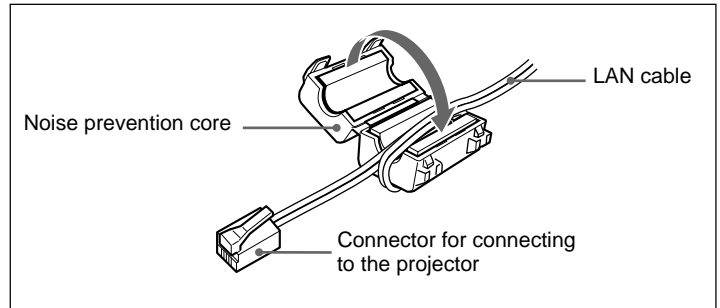

Connection of wireless LAN PC card

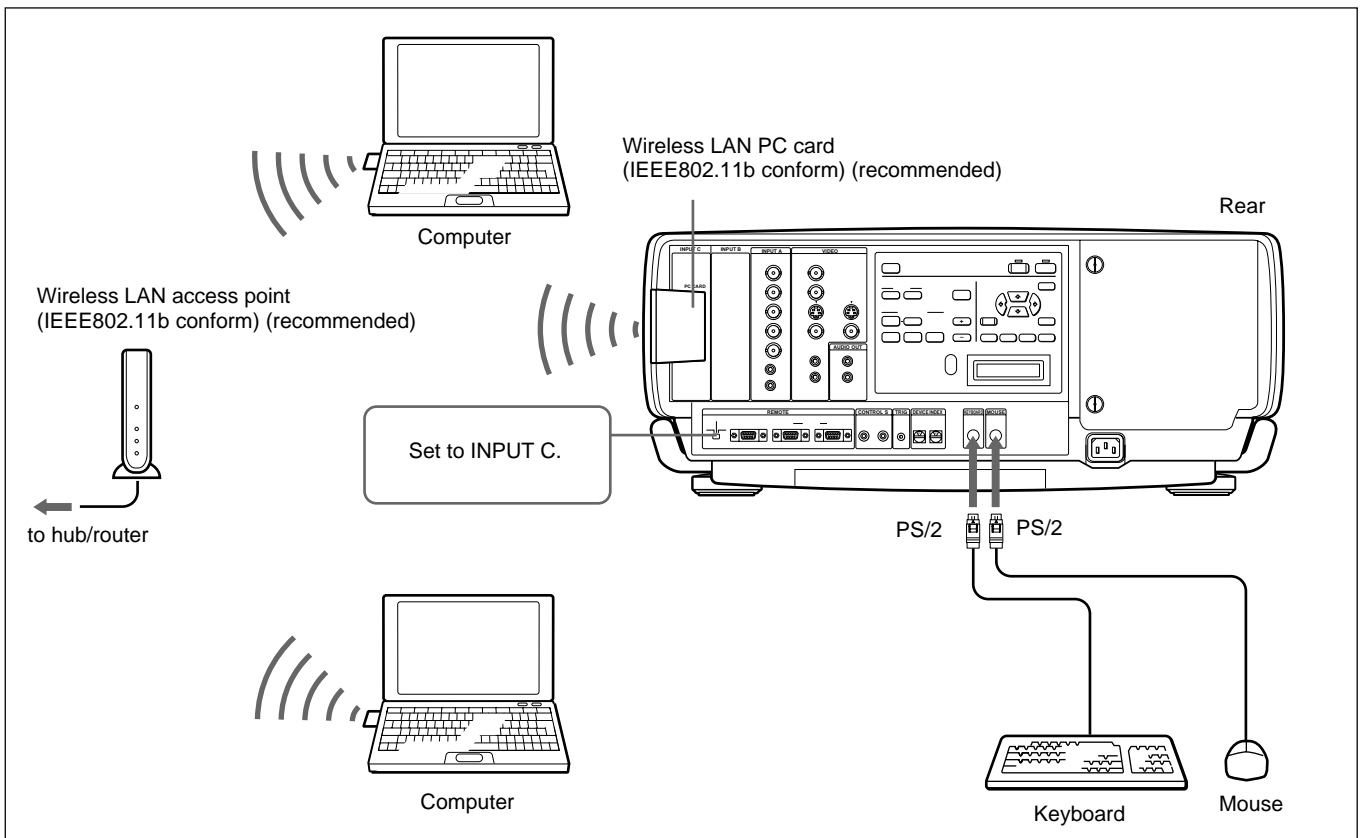

Installing a memory card

You can memorize the presentation file made by the Microsoft PowerPoint¹⁾ in the memory card and show the file by inserting the memory card into the PC card slot of the projector.

For attaching and removing the memory card, see “Installing a PC card” on page 19.

For details of the recommended PC card, see the attached “Recommended PC card/wireless LAN access point.”

1) PowerPoint is a registered trademark of Microsoft Corporation in the United States and/or other countries.

Connecting with a Computer or a VCR

This section describes how to connect the projector with a computer, VCR, and external active speakers.

For details on how to connect other equipment, see pages 32 to 34.

Also refer to the instruction manuals of the equipment to be connected.

When making connections, be sure to:

- turn off all equipments before making any connections.
- use the proper cables for each connection.
- insert the plugs of the cables properly; plugs that are not fully inserted often generate noise. When pulling out a cable, be sure to pull it out by the plug, not the cable itself.

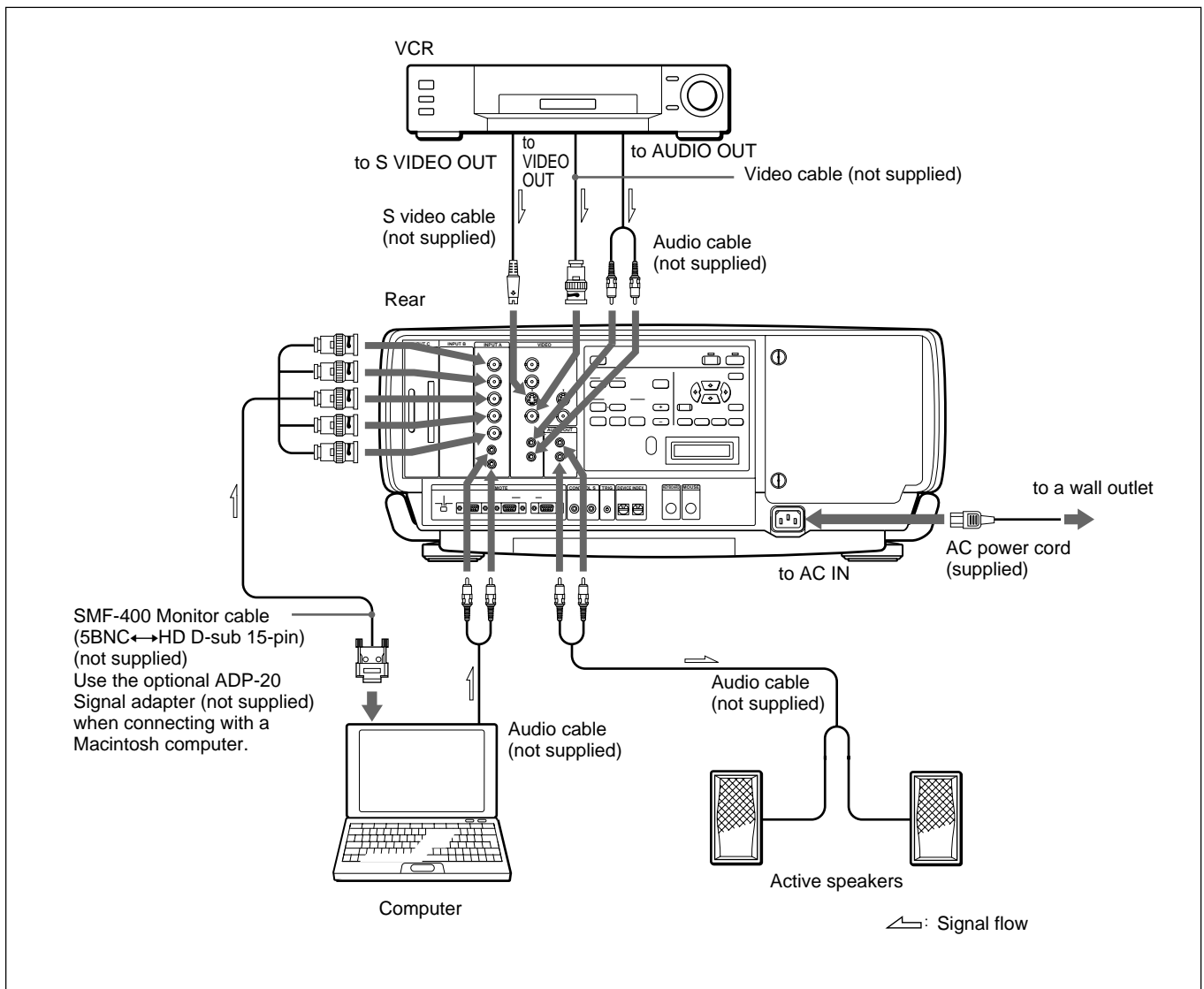

Note

Set INPUT-A in the SIGNAL SELECT menu to COMPUTER.
For details, see page 31.

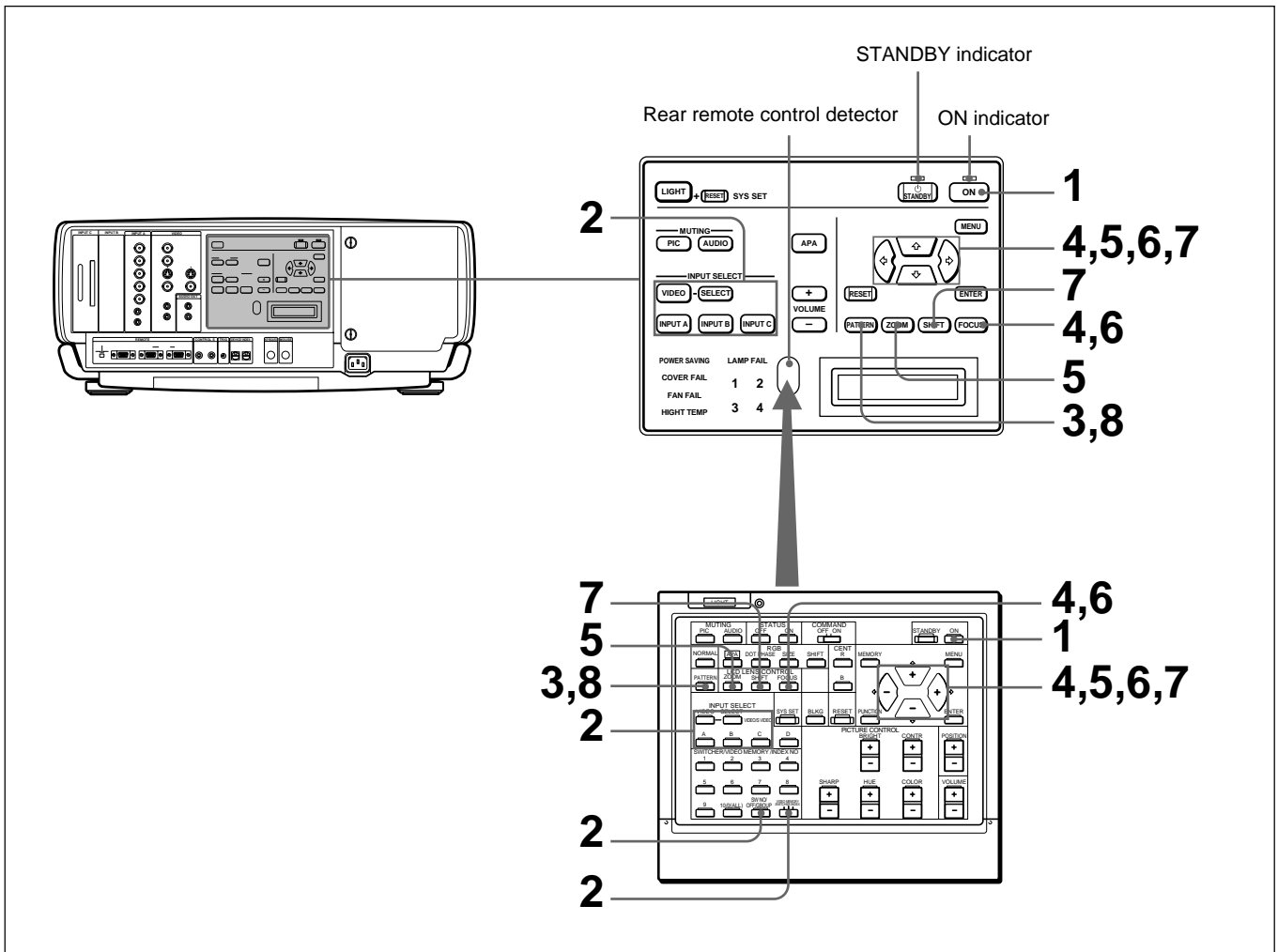

1 Press the ON key on the Remote Commander or the control panel.

The ON indicator lights in green.

2 Turn on the power of equipment connected to the projector. Press the INPUT SELECT keys on the Remote Commander or the control panel to select the input source.

VIDEO: Selects the video signal input from the VIDEO or S VIDEO connectors and the audio signal input from the AUDIO IN L/R jacks. To switch the VIDEO or S VIDEO connectors, use the SELECT key.

SELECT: Each time you press this key, the input signal is switched between VIDEO and S VIDEO.

INPUT A: Selects the audio and video signals input from the INPUT A connectors.

INPUT B: Selects the signal input from the connectors on the optional interface board which is installed in the INPUT B section.

INPUT C: Selects the Windows CE.

When you input the signal from equipment connected to the PC-3000 signal interface switcher (not supplied), set the SWITCHER/VIDEO MEMORY/INDEX select switch on the Remote Commander to the SWITCHER position and press the number keys to select the input. When multiple switchers are connected, press the SW NO/OFF/ GROUP key, then press the number keys to select the input.

Note

Press the SYS SET key when you make the system connections using the PC-3000 switcher.

- 3** Press the PATTERN key on the Remote Commander or the control panel to display the HATCH pattern.

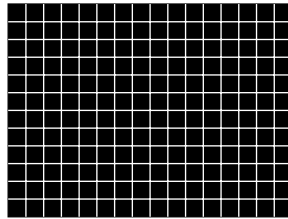

- 4** Press the FOCUS key then the \blacktriangle or \blacktriangledown key on the Remote Commander or the control panel to adjust the focus.

“FOCUS” appears on the screen during adjustment.

- 5** Press the ZOOM key then the \blacktriangle or \blacktriangledown key on the Remote Commander or the control panel to adjust the picture size.

“ZOOM” appears on the screen during adjustment.

Note

If the optional VPLL-2075, VPLL-2014, VPLL-2009 or VPLL-3050 lens is installed, you cannot adjust the zoom.

- 6** Press the FOCUS and arrow keys on the Remote Commander or the control panel to adjust the focus again.

“FOCUS” appears on the screen during adjustment.

(continued)

- 7 Press the SHIFT key then the arrow keys on the Remote Commander or the control panel to adjust the vertical position of the picture.

“PICTURE SHIFT” appears on the screen during adjustment.

- 8 Press the PATTERN key again to clear the HATCH pattern.

| To | Press |
|---------------------|---|
| Adjust the volume | the VOLUME +/- keys. |
| Cut off the sound | the AUDIO MUTING key (also cuts off the signal output from the AUDIO OUT jacks.) To restore the sound, press the AUDIO MUTING key again or press the VOLUME + key. |
| Cut off the picture | the PIC MUTING key. To restore the picture, press the PIC MUTING key again. |

Note

Do not look into the lens when the projector lamp is on.

To turn off the power

- 1 Press the STANDBY key on the Remote Commander or the control panel.

The ON indicator flashes in green and the cooling fan keeps running for about six minutes to reduce the internal heat. The ON indicator flashes quickly for one minute. During this time, you will not be able to turn the power back on. After about one minute, you can turn on the power with the ON key.

When the fan stops running, the STANDBY indicator lights in red.

Note

To extend the lamp life, do not turn off the power for at least 10 minutes after turning on the power.

Using the Menu

The projector is equipped with an on-screen menu for making various adjustments and settings.

Unadjustable items are not displayed in the menu.

To change the language used in the menu, see page 30.

1 Press the MENU key.

The menu display appears.

The menu presently selected is highlighted in yellow.

| PICTURE CTRL | VIDEO |
|-----------------|-------|
| CONTRAST: 80 | |
| BRIGHT: 50 | |
| COLOR: 50 | |
| HUE: 50 | |
| SHARP: 50 | |
| D.PICTURE: OFF | |
| COLOR TEMP: LOW | |
| COLOR SYS: AUTO | |

2 Use the **▲** or **▼** key to select a menu, then press the **▶** or the ENTER key.

The setting items of the selected menu are displayed.

| Menus | Setting items |
|----------------------------|---------------|
| SET SETTING | INPUT-A |
| STATUS: ON | |
| SPEAKER: ON | |
| LANGUAGE: ENGLISH | |
| INSTALLATION: FLOOR-FRONT | |
| POWER SAVING: OFF | |
| SIRCS RECEIVER: FRONT&REAR | |
| GROUP INDEX: 0 1 | |
| DEVICE INDEX: 0 1 | |

3 Use the **▲** or **▼** key to select the item, then press the **▶** or the ENTER key.

4 Adjust an item.

• **When changing the adjustment level:**

To increase the number, press the **▲** or **▶** key.

To decrease the number, press the **▼** or **◀** key.

Press the ENTER key to restore the original screen.

• **When changing the setting:**

Press the **▲** or **▼** key to change the setting, then press the **◀** or the ENTER key.

The original screen is restored.

For details on setting individual items, see the relevant menu pages.

To erase the menu display

Press the MENU key. The menu display also disappears automatically if no key is pressed for one minute.

To reset settings that have been adjusted

Press the RESET key.

“Reset complete!” appears on the screen and the settings appearing on the screen will be reset to their factory preset values.

Items that can be reset are as follows:

CONTRAST, BRIGHT, COLOR, HUE, SHARP, DOT PHASE, SIZE, SHIFT and BLANKING.

About the memory of the settings

The settings are automatically stored in the projector memory.

The PICTURE CTRL Menu

The PICTURE CTRL menu is used for adjusting the picture. Unadjustable items are not displayed in the menu.

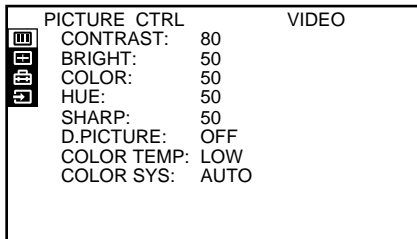

CONTRAST

Adjusts the picture contrast.
The higher the setting, the greater the contrast.
The lower the setting, the lower the contrast.

BRIGHT (Brightness)

Adjusts the picture brightness.
The higher the setting, the brighter the picture.
The lower the setting, the darker the picture.

COLOR

Adjusts color intensity.
The higher the setting, the greater the intensity.
The lower the setting, the lower the intensity.

HUE

Adjusts the color tones.
At high settings, the picture becomes greenish.
At low settings, the picture becomes purplish.

SHARP (Sharpness)

Adjusts the picture sharpness.
The higher the setting, the sharper the picture.
The lower the setting, the softer the picture.

D. (Dynamic) PICTURE

Emphasizes the black color.
ON: Emphasizes the black color to produce a bolder “dynamic” picture.
OFF: Reproduces the dark portions of the picture accurately, in accordance with the source signal.

COLOR TEMP (temperature)

Adjusts the color temperature.
HIGH: Makes the white color bluish.
LOW: Makes the white color reddish.

COLOR SYS (system)

Selects the color system of the input signal.
Normally, set to AUTO.
If the picture is distorted or colorless, select the color system (NTSC_{3.58}/PAL/SECAM/NTSC_{4.43}/PAL-M) according to the input signal.

GAMMA MODE

Select either position to obtain an optimum picture.
GRAPHICS: Improves the reproduction of half tones. Photos can be reproduced in natural tones.
TEXT: Contrasts black and white. Suitable for images with lots of text.

Input signals and adjustable/setting items

| Item | Input signal | | | | | |
|------------|---|---------|----------------------------------|--------------|--------------------------|------------------|
| | Video or S video | 15k RGB | Component/ progressive component | RGB (preset) | RGB (preset) (HDTV, DTV) | RGB (not preset) |
| CONTRAST | Y | Y | Y | Y | Y | Y |
| BRIGHT | Y | Y | Y | Y | Y | Y |
| COLOR | Y | Y | Y | N | Y | N |
| HUE | Y (NTSC 3.58/ 4.43 ¹⁾ only) | Y | Y | N | Y | N |
| SHARP | Y | Y | Y | N | Y | N |
| D. PICTURE | Y | N | Y | N | N | N |
| COLOR TEMP | Y | Y | Y | Y | Y | Y |
| COLOR SYS | Y | N | N | N | N | N |
| GAMMA MODE | N | N | N | Y | N | Y |

Y: Adjustable/can be set
N: Not adjustable/cannot be set

1) NTSC_{4.43} is the color system used when playing back a video recorded in NTSC color system on a NTSC_{4.43} system VCR.

The INPUT SETTING Menu

The INPUT SETTING menu is used to change the settings of the input signal. Unadjustable items, which vary according to the input signal, are not displayed in the menu.

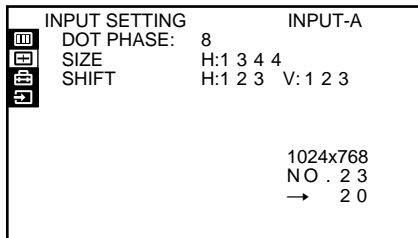

DOT PHASE

Adjusts the phase of the LCD panel and the input signal when H FILTER is set to OFF. Adjust the value to obtain the clearest picture.

SIZE

Adjusts the horizontal size of the picture. As the setting for H increases, the horizontal size of the picture becomes larger, and as the setting decreases, the size becomes smaller. Adjust the setting according to the input signal. Use the ◀ or ▶ key to adjust the horizontal size.

SHIFT

Adjusts the position of the picture. H adjusts the horizontal position of the picture, and V adjusts the vertical position. As the setting for H increases, the picture moves to the right, and as the setting decreases, it moves to the left. As the setting for V increases, the picture moves up, and as the setting decreases, it moves down. Use the ◀ or ▶ key to adjust the horizontal position and the ▲ or ▼ key for the vertical position.

SCAN CONV (converter)

Converts the signal to display the picture so that it fits the screen size.

ON: Displays the picture to fill the 4:3 screen. The picture will lose some clarity.

OFF: Displays the picture while matching one pixel of input picture element to that of the LCD. The picture will be clear but the picture size will be smaller.

Note

The function does not work for signals in Memory No. 32 and 33.

ASPECT

Sets the aspect ratio of the picture. When inputting 16:9 (squeezed) signal from equipment such as a DVD player, set to 16:9.

4:3: When the picture with ratio 4:3 is input

16:9: When the picture with ratio 16:9 (squeezed) is input

H FILTER

Corrects the vertical bands that appear on the picture. The vertical bands may occur when an RGB signal with horizontal resolution of more than 1280 × 1024 pixels is input. In such cases, set to ON. The picture will lose some clarity, but the vertical bands will be reduced. Set to OFF to associate a dot of the input signal with a pixel of the LCD.

BLANKING

Adjusts if excess signals are seen with the picture, or the whole picture is not seen clearly. Select BLANKING, then press the ENTER key to display the blanking adjustment screen. Use the ▲ or ▼ key to select the part to be adjusted (TOP, BOTTOM, RIGHT or LEFT), and the ◀ or ▶ key to adjust.

The INPUT SETTING Menu

Input signals and adjustable/setting items

| Item | Input signal | | | | |
|-----------|----------------------------|----------------------------|----------------------------------|--|--|
| | Video or S video | 15k RGB | Component/ Progressive component | RGB (preset) | RGB (not preset) |
| DOT PHASE | N | N | N | Y (except for HDTV, DTV) | Y |
| SIZE | N | N | Y | Y | Y |
| SHIFT | Y | Y | Y | Y | Y |
| SCAN CONV | N | N | N | Y (Only for lower resolution than SXGA) | Y (Only for lower resolution than SXGA) |
| ASPECT | Y | Y | Y | N | N |
| H FILTER | N | N | N | Y (UXGA only) | Y (UXGA only) |
| BLANKING | Y (TOP and BOTTOM only) | Y (TOP and BOTTOM only) | Y (TOP and BOTTOM only) | Y (HDTV, DTV only) | Y |

Y: Adjustable/can be set
N: Not adjustable/cannot be set

INPUT MEMORY No.

The upper number indicates the memory number of the current input signal. The lower number indicates the user memory number.

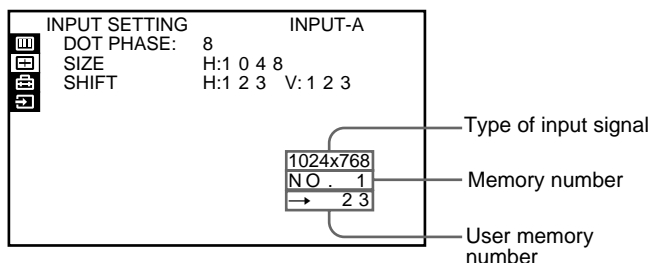

About the memory function

The adjustment data for 48 types of input signals are preset at the factory (preset memory).

When a signal is input to the projector, the signal type is automatically detected and the data for the signal is called from the memory to display an optimum picture. The data can be adjusted in the INPUT SETTING menu and the adjusted data will be saved as user memory.

When you save more than 200 user memories, the newest one always overwrites the oldest one.

The saved user memory number is displayed in the INPUT SETTING menu as → NO. □□.

When an RGB signal other than the preset signals is input to the projector, the memory number is displayed as 0 and the closest option is automatically selected from the preset 48 types of signals.

Notes

- When an RGB signal is input with sync on Green including external sync, the picture tone may be greenish. In this case, disconnect the external sync signal.
- When an HDTV 1035/60i signal is input, the picture will appear smaller. Adjust SIZE, SHIFT and BLANKING referring to the following levels as a standard.

SIZE H: 1479
SHIFT H: 321
V: 41
BLANKING TOP: 167
BOTTOM: 167
RIGHT: 27
LEFT: 27

- If SCAN CONV is set to ON when a signal in Memory No. 34–38 is input, the picture will appear widened. Adjust SIZE and SHIFT, referring to the following levels as a standard.

| Memory No. | 34 | 35 | 36 | 37 | 38 |
|------------|------|------|------|------|------|
| SIZE | 1590 | 1575 | 1590 | 1582 | 1620 |
| SHIFT | H | 181 | 170 | 182 | 154 |
| | V | 18 | 32 | 36 | 36 |

| Memory No. | Preset signal | fH (kHz) | fV (Hz) | Sync | Horizontal size | |
|------------|-----------------|-----------------------|---------|----------|-----------------|------|
| 1 | Video 60 Hz | 15.73 | 59.94 | — | — | |
| 2 | Video 50 Hz | 15.63 | 50.00 | — | — | |
| 3 | 15k RGB (60 Hz) | 15.73 | 59.94 | S on G | — | |
| 4 | 15k RGB (50 Hz) | 15.63 | 50.00 | S on G | — | |
| 5 | HDTV | 33.75 | 60.00 | S on Y/G | 1543 | |
| 6 | 640 × 350 | VGA-1 (VGA350) | 31.47 | 70.09 | H-pos V-neg | 800 |
| 7 | | VESA* 85(VGA350) | 37.86 | 85.08 | H-pos V-neg | 832 |
| 8 | 640 × 400 | NEC PC98 | 24.82 | 54.42 | H-neg V-neg | 848 |
| 9 | | VGA-2 (TEXT) /VESA70 | 31.47 | 70.09 | H-neg V-pos | 800 |
| 10 | | VESA 85 (VGA400) | 37.86 | 85.08 | H-neg V-pos | 832 |
| 11 | 640 × 480 | VGA VESA60 | 31.47 | 59.94 | H-neg V-neg | 800 |
| 12 | | Mac 13 | 35.00 | 66.67 | S on G | 864 |
| 13 | | VGA VESA 72 | 37.86 | 72.81 | H-neg V-neg | 832 |
| 14 | | VGA VESA 75 (IBM M3) | 37.50 | 75.00 | H-neg V-neg | 840 |
| 15 | | VGA VESA 85 (IBM M4) | 43.27 | 85.01 | H-neg V-neg | 832 |
| 16 | 800 × 600 | SVGA VESA 56 | 35.16 | 56.25 | H-pos V-pos | 1024 |
| 17 | | SVGA VESA 60 | 37.88 | 60.32 | H-pos V-pos | 1056 |
| 18 | | SVGA VESA 72 | 48.08 | 72.19 | H-pos V-pos | 1040 |
| 19 | | SVGA VESA 75 (IBM M5) | 46.88 | 75.00 | H-pos V-pos | 1056 |
| 20 | | SVGA VESA 85 | 53.67 | 85.06 | H-pos V-pos | 1048 |
| 21 | 832 × 624 | Mac 16 | 49.72 | 74.55 | H-neg V-neg | 1152 |
| 22 | 1024 × 768 | XGA VESA 43 (8514) | 35.52 | 86.96 | H-pos V-pos | 1264 |
| 23 | | XGA VESA 60 | 48.36 | 60.00 | H-neg V-neg | 1344 |
| 24 | | XGA VESA 70 | 56.48 | 69.96 | H-neg V-neg | 1328 |
| 25 | | XGA VESA 75 | 60.02 | 75.03 | H-pos V-pos | 1312 |
| 26 | | XGA VESA 85 | 68.68 | 85.00 | H-pos V-pos | 1376 |
| 27 | 1152 × 864 | VESA 70 | 64.00 | 70.02 | H-pos V-pos | 1472 |
| 28 | | VESA 75 | 67.50 | 75.00 | H-pos V-pos | 1600 |
| 29 | | VESA 85 | 77.49 | 85.06 | H-pos V-pos | 1568 |
| 30 | 1152 × 900 | SUN LO | 61.80 | 65.96 | H-neg V-neg | 1504 |
| 31 | | SUN HI | 71.71 | 76.05 | C-neg | 1472 |
| 32 | 1280 × 960 | VESA 60 | 60.00 | 60.00 | H-pos V-pos | 1800 |
| 33 | | VESA 75 | 75.00 | 75.00 | H-pos V-pos | 1728 |
| 34 | 1280 × 1024 | SXGA VESA 43 | 46.43 | 86.87 | H-pos V-pos | 1696 |
| 35 | | SXI-5 | 53.32 | 50.06 | H-neg V-neg | 1680 |
| 36 | | SXGA VESA 60 | 63.97 | 60.01 | S on G | 1696 |
| 37 | | SXGA VESA 75 | 79.98 | 75.03 | H-pos V-pos | 1688 |
| 38 | | SXGA VESA 85 | 91.15 | 85.02 | H-pos V-pos | 1728 |

| Memory No. | Preset signal | fH (kHz) | fV (Hz) | Sync | Horizontal size | |
|------------|---------------------------------|--------------|---------|--------|-----------------|------|
| 39 | 1600 × 1200 | UXGA VESA 60 | 75.00 | 60.00 | H-pos V-pos | 1689 |
| 40 | | UXGA VESA 65 | 81.91 | 65.53 | H-pos V-pos | 1689 |
| 41 | | UXGA VESA 75 | 93.75 | 75.00 | H-pos V-pos | 1689 |
| 43 | 480/60p (Progressive component) | 31.47 | 60.00 | S on G | 1605 | |
| 44 | 575/50p (Progressive component) | 31.25 | 50.00 | S on G | 1616 | |
| 45 | 1080/50i | 28.13 | 50.00 | — | 1852 | |
| 47 | 720/60p | 45.00 | 60.00 | — | 1736 | |
| 48 | 720/50p | 37.50 | 50.00 | — | 2084 | |
| 49 | 1080/24PsF | 27.00 | 48.00 | — | 1929 | |

* VESA is a registered trademark of Video Electronics Standard Association.

The SET SETTING Menu

The SET SETTING menu is used for changing the initial settings of the projector. Unadjustable items are not displayed in the menu.

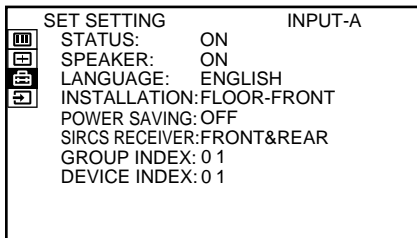

STATUS

Sets up the on-screen display.

ON: Shows all of the on-screen displays.

OFF: Turns off the on-screen displays except for the menus and warning messages.

SPEAKER

Set to OFF to cut off the sound of the internal speaker when external speakers are connected. When set to OFF, "SPEAKER OFF" appears on the screen when you turn on the power.

LANGUAGE

Selects the language used in the menu and on-screen displays.

Available languages are: English, French, German, Italian, Spanish, Japanese and Chinese.

INSTALLATION

Reverses the picture horizontally or vertically.

FLOOR-FRONT: The picture is not reversed.

CEILING-FRONT: The picture is reversed horizontally and vertically.

FLOOR-REAR: The picture is reversed horizontally.

CEILING-REAR: The picture is reversed vertically.

Note

In case of using a mirror, be careful of installation since the picture may be reversed.

POWER SAVING

When set to ON, the projector goes into the power saving mode and the lamp for light source turns off if no signal is input for about 10 minutes.

The power saving mode is canceled when a signal is input or any key is pressed.

SIRCS RECEIVER

Selects the remote control detectors to be activated. Change the setting if the wireless Remote Commander does not work properly due to the influence of the fluorescent lamp, etc.

FRONT & REAR: Activates both the front and rear detectors.

FRONT: Activates the front detector only.

REAR: Activates the rear detector only.

OFF: Activates neither the front nor rear detector.

Note

When set to OFF, the wireless Remote Commander does not function. Use the keys on the control panel or the wired Remote Commander.

GROUP INDEX

Groups multiple projectors or switchers to operate them simultaneously.

You can set the group index number to the desired number between 01 and 99.

For details for setting the group index, see pages 35 and 36.

DEVICE INDEX

Displays the index number set with the INDEX switches on the rear of the projector. You can check the device index number but cannot set it with this menu.

For details for setting the number, see page 35.

The SIGNAL SELECT Menu

The SIGNAL SELECT Menu is used for selecting the input signal.

Depending on the interface board installed in the projector, some items may not be displayed in the menu.

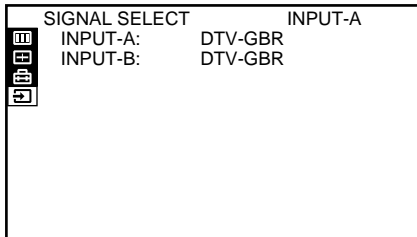

Use the **▲** or **▼** key to select the input, then press the ENTER key.

INPUT-A

Selects audio and video signals input from the INPUT A connectors.

COMPUTER: Inputs the signal from a computer or the RGB signal for a still picture.

COMPONENT: Inputs the component signal.

DTV-YP_BPR: Inputs the DTV (YP_BPR) or HDTV (YP_BPR) signal.

DTV-GBR: Inputs the DTV (GBR) or HDTV (GBR) signal.

Note

When the PC-3000 signal interface switcher is connected to the INPUT A connectors, you cannot select the item.

INPUT-B

Selects the input signal from the connectors on the optional IFB-12A interface board installed in the INPUT B section.

COMPUTER: Inputs the signal from a computer or the RGB signal for a still picture.

COMPONENT: Inputs the component signal.

DTV-YP_BPR: Inputs the DTV (YP_BPR) or HDTV (YP_BPR) signal.

DTV-GBR: Inputs the DTV (GBR) or HDTV (GBR) signal.

VIDEO: Inputs the composite video signal.

S-VIDEO: Inputs the S video signal.

Note

This item is not displayed when the optional interface board other than the IFB-12A is installed in the INPUT B section, or when the output mode is selected on the IFB-12A.

Connection Examples

For details on how to connect to LAN, see page 19.
For details on how to connect a computer, VCR or external active speakers, see page 21. Also refer to the instruction manual of the equipment to be connected.

When making connections, be sure to:

- turn off all equipments before making any connections.
- use the proper cables for each connection.
- insert the plugs of the cables properly; plugs that are not fully inserted may generate noise. When pulling out a cable, be sure to pull it out from the plug, not the cable itself.

Connecting a BNC connector

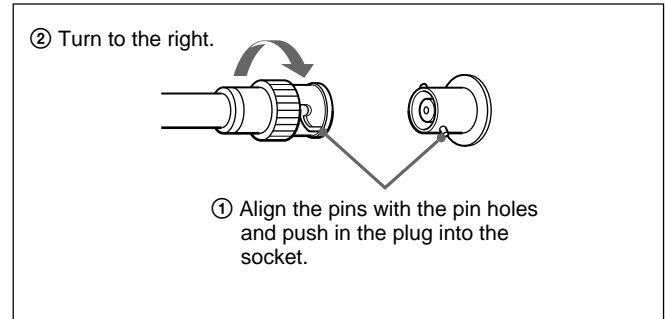

Connecting 15k RGB/Component Equipment

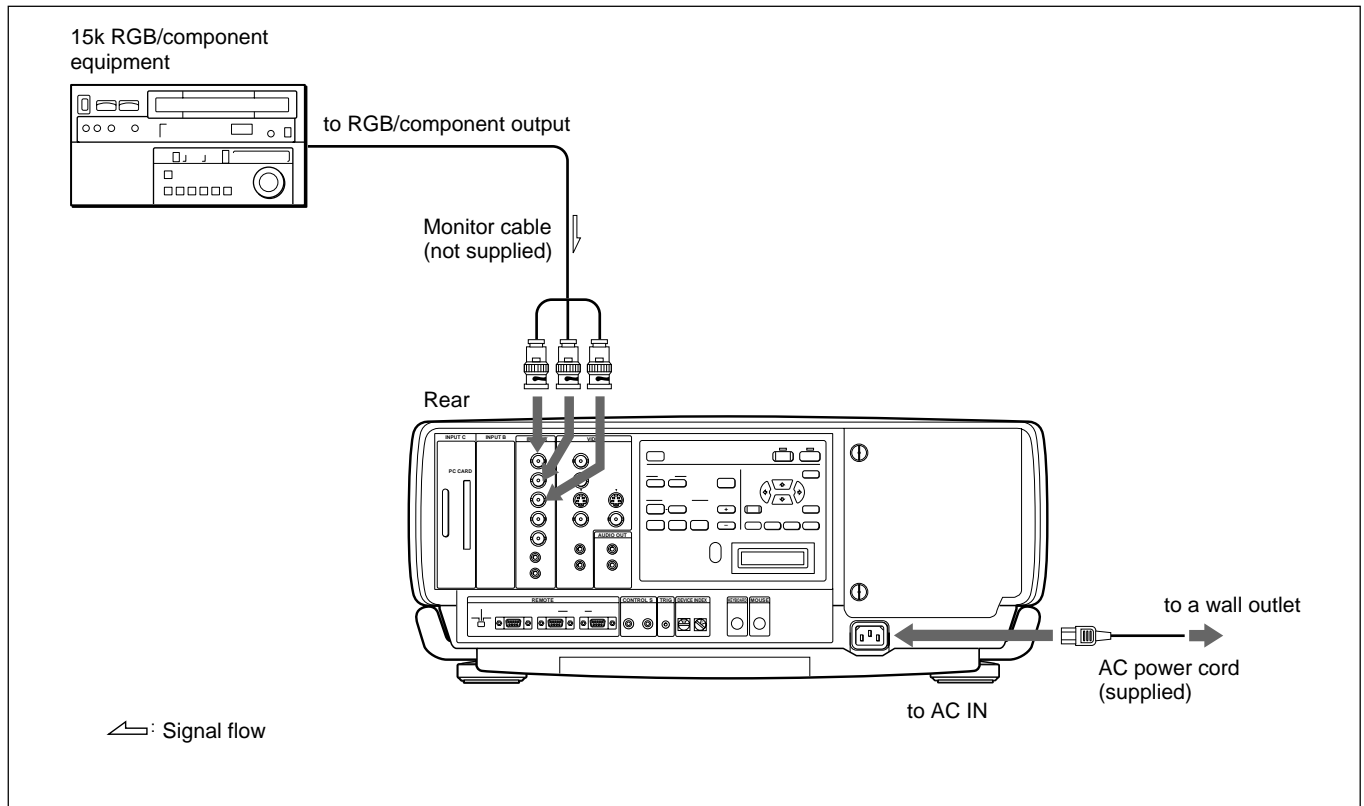

Note

Switch the input signal with the INPUT-A item in the SIGNAL SELECT menu.

For details, see page 31.

Connecting the Switcher

Use the optional PC-3000 Signal Interface Switcher for connecting various video equipment. The input can be selected by pressing the SWITCHER/VIDEO MEMORY/INDEX keys on the Remote Commander. *For selecting the input from the switcher, see page 15.*

Notes

- When you select the input from the switcher, be sure to set the SWITCHER/VIDEO MEMORY/INDEX select switch to the SWITCHER position.

- When connecting the switcher, use the wired Remote Commander. If you use the wireless Remote Commander, it activates the remote control detector on only one unit of the equipment connected through the PJ COM connector. For the other equipment, set SIRCS RECEIVER in the SET SETTING menu to OFF to deactivate the remote control detectors. *For details, see page 30.*
- After all the connections are completed, attach the terminator (supplied) to the PJ COM connector on both the projector and switcher to which nothing is connected.

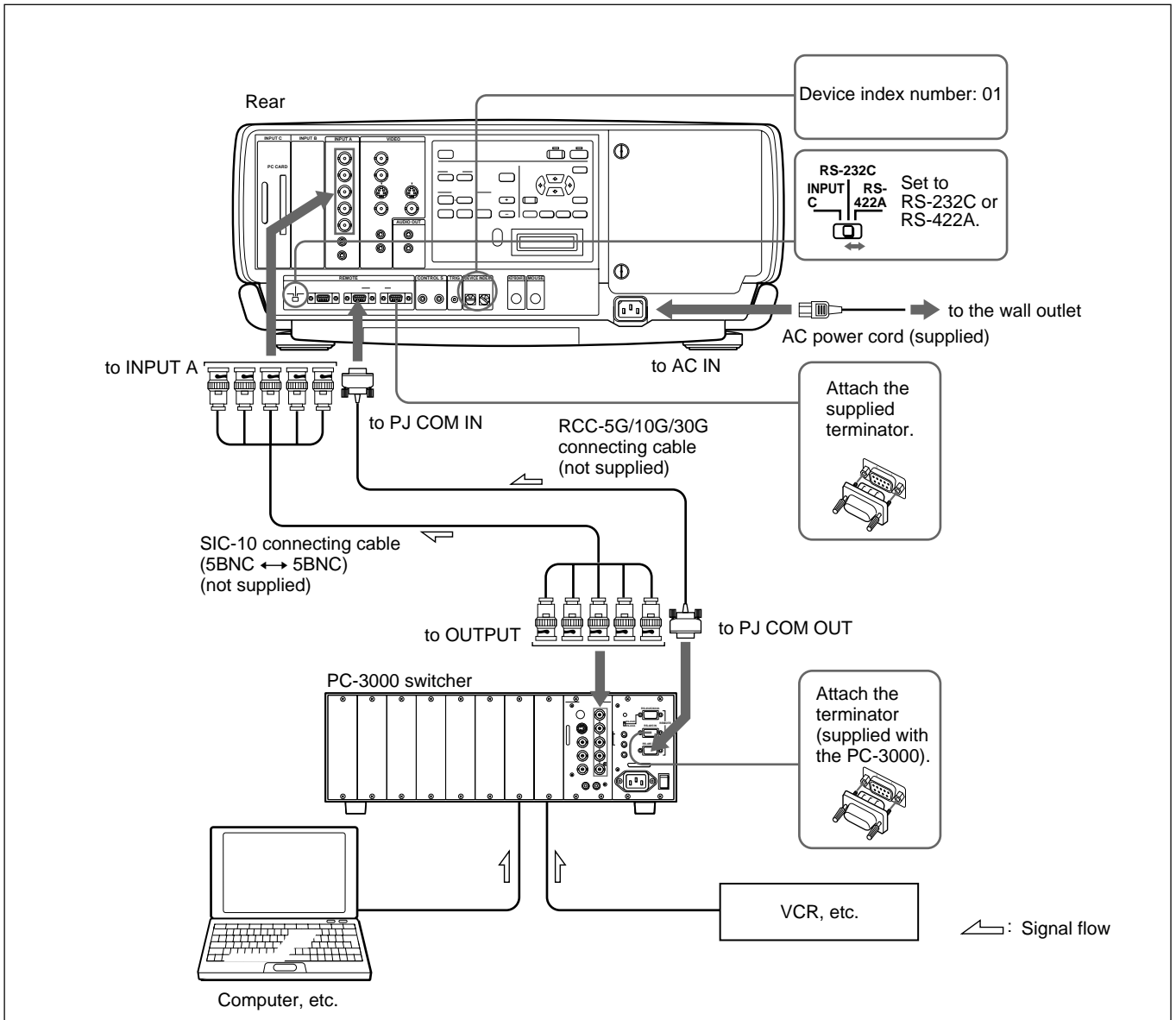

Confirming the System Construction

After all the connections are complete, confirm that equipment of the system is properly setup.

- 1** Connect the AC cords of all equipment to the AC outlets.
- 2** Press the SYS SET key on the Remote Commander.
You can also press the LIGHT and RESET keys simultaneously on the control panel for the same effect.
Information on the system construction and the settings of the interface boards, etc. are automatically confirmed. Then the message disappears.

Note

When you want to use the projector without connecting the switcher after using the switcher in the system connections, it is necessary to confirm the system construction again by pressing the SYS SET key or the LIGHT and RESET keys after all the connections are completed. If you press the key(s), “Master Switcher not exist” appears, but the system construction is automatically recognized.

When a system error is detected

The following messages are displayed on the screen and display window:

| Message | Remedy |
|---|--|
| Master Switcher not exist. | Set the switcher that outputs the signal to the projector to number 1. |
| Same DEVICE INDEX for Projector detected. | Change either number of the projectors that have the same number. |
| Same DEVICE INDEX for Switcher detected. | Change either number of the switchers that have the same number. |

Note

If the switcher is in standby mode, the message appears only in the message display window.

Setting the Index Numbers

When you connect multiple projectors in your system, you have to set the group index and device index numbers for each projector.

To set the group index number

If you set the same group index number for multiple projectors, you can operate multiple projectors and switchers simultaneously (such as input selection) by designating the number.

The group index number can be set in the menu.

For group index number setting, see page 30.

To set the device index number

If you set the device index number, you can control each projector individually with the supplied Remote Commander.

The device index number can be set with the DEVICE INDEX switches on the rear of the projector. It is set to "01" at the factory.

If only one projector is connected, set it to "01."

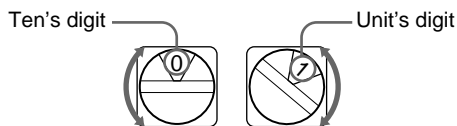

Notes

- Do not set the same device index number for the projectors in the same system.
- Do not set the number to "00." If you do, the projector will be operated only with the keys on the control panel. It cannot be controlled with the wired or wireless Remote Commander, or with an external equipment to which the PJ COM connectors are connected.

Notes on setting of the index number

- Set the same group index number for all equipment of the same system connection (those on the signal route between the signal source and the projector).

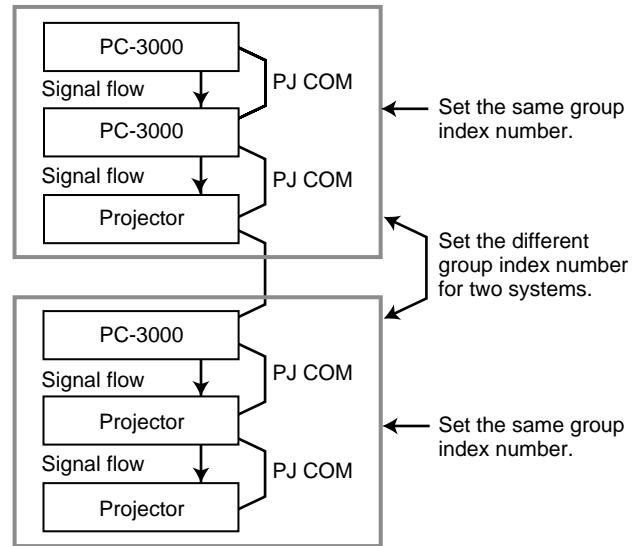

For setting the group index number, see "GROUP INDEX" on page 30.

- Set the correct group and device index numbers and the switcher number.

Do not set the same device index number or the same switcher number in one group.

For example, if there are different pieces of equipment with the switcher number 1, the error message will appear when the SYS SET key is pressed.

- Set the switcher that outputs the signal to the projector to number 1.

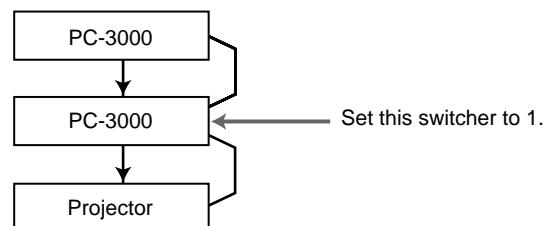

Setting the Index Numbers

Notes on connections when two or more switchers are used

- Mount the IFB-12A interface board to the slot 1 of the number n switcher and connect the output connector of the number (n+1) switcher to the IFB-12A.
- You can attach the IFB-12A signal interface board (when the IN/OUT switch is set to OUT) only to the number 1 switcher.

To select the projector by designating the index numbers

When the switchers and projectors are connected as illustrated, select the desired projector by pressing the keys on the Remote Commander as shown below.

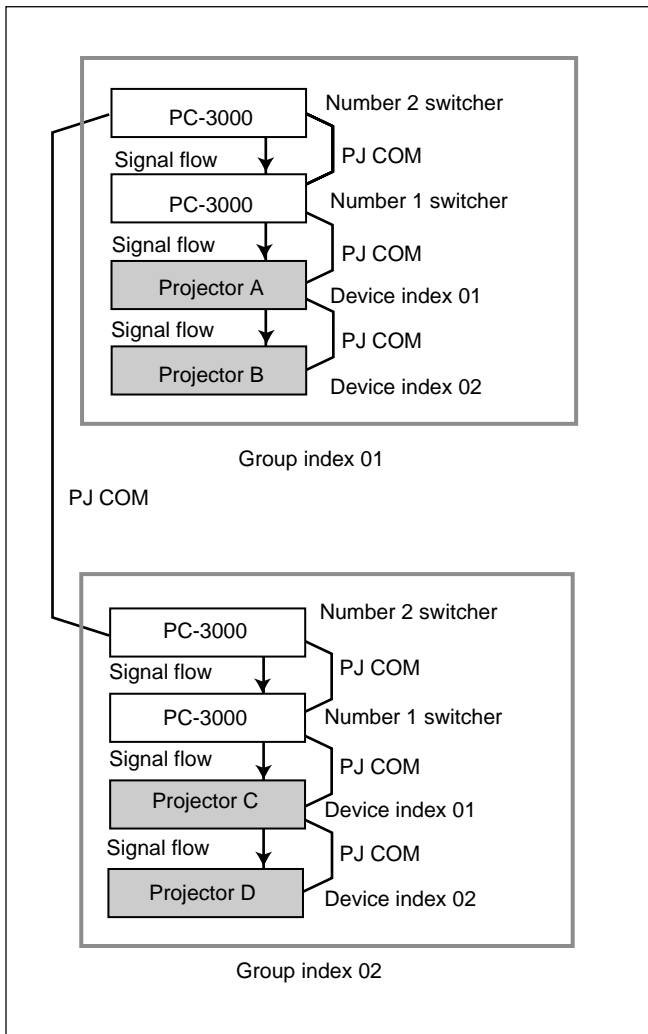

Example:

To select all the projectors
 GROUP → ALL → ENTER → ALL →
 ENTER
 Projectors A, B, C and D are selected.

To select projectors with device index 01 from all the groups
 GROUP → ALL → ENTER → 1 → ENTER
 Projectors A and C are selected.

To select a projector with device index 01 from group index 02
 GROUP → 2 → ENTER → 1 → ENTER
 Projector C is selected.

To select all the projectors from group index 02
 GROUP → 2 → ENTER → ALL → ENTER
 Projectors C and D are selected.

Notes

- Set the group index and device index numbers correctly. If more than two projectors are set to the same group index and device index numbers, an error message will be displayed when the SYS SET key is pressed.
- If the group index is a tens digit number, press the GROUP key before each press of the number key.

Example:

To select a projector with device index 13 of group index 12
 GROUP → 1 → GROUP → 2 → ENTER →
 1 → 3 → ENTER

Replacing the Lamp

When the lamp has burnt out, the LAMP FAIL indicators at the rear of the projector light. In this case, replace the lamp with a new LMP-Q130 Projector Lamp (not supplied).

Note

Immediately after turning off the power, the lamp is extremely hot. Wait at least one hour before changing the lamp to give it enough time to cool down.

Disposal of the used lamp

As the used lamp contains Mercury, dispose of the lamp according to local, state or federal laws.

As the materials used in this lamp are similar to those of a fluorescent lamp, you should dispose of a used projector lamp in the same way as a fluorescent lamp.

To remove the lamp

- 1 Press the STANDBY key to set the projector to standby mode, and unplug the power cord.
- 2 Remove the two screws with a coin or similar object, or a screwdriver, to open the lamp cover.

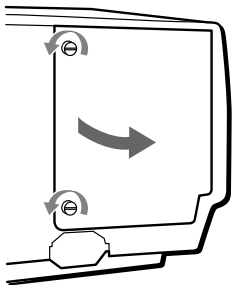

- 3 Loosen the two screws that fasten the lamp.

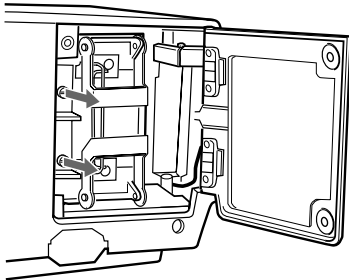

- 4 Fold out the levers up and down.

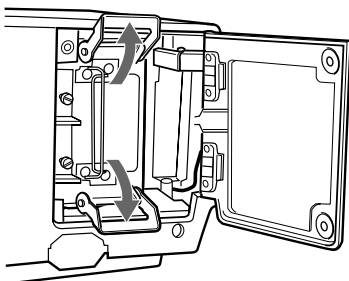

- 5 Pull out the lamp by holding the handles.

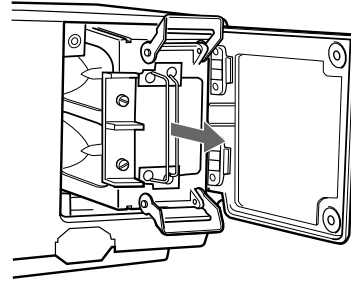

To install a new lamp

- 1 Mount the lamp with the grooves on the top and bottom aligned with the guides on the projector.

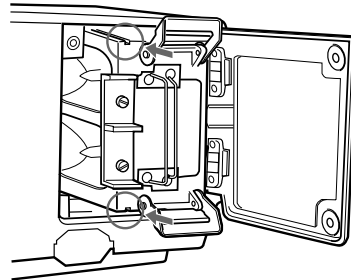

- 2 Push the lamp completely until it clicks. Fold down the levers to fix the lamp to the projector.

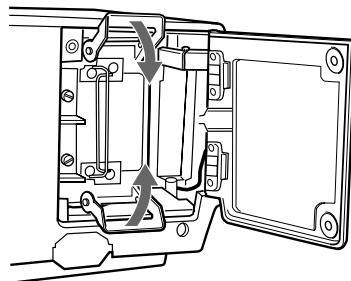

- 3 Tighten the two screws to secure the lamp.

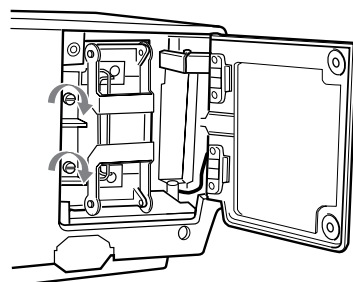

(continued)

Maintenance

- 4 Replace the lamp cover and push to tighten the two screws to fix the cover.

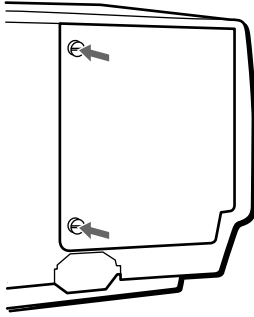

To reset the use time of the lamps in the message display window

- 1 Plug in the power cord and set the projector to standby mode.
- 2 Press the LIGHT, ←, → and ENTER keys on the control panel in sequence. Press each key within 5 seconds.

TIMER RESET?
LAMP: 1

- 3 Press the ↑, ↓, ← or → key to display ALL.

TIMER RESET?
LAMP: ALL

- 4 Press the ENTER key.

TIMER RESET??
LAMP: ALL

- 5 Press the ENTER key again to reset the time.
- 6 To exit the reset mode, display EXIT and press the ENTER key.

Cleaning the Air Filter

The air filter should be cleaned in every 100 hours. When it becomes difficult to remove the dust from the filter, replace the filter with a new one.

- 1 Turn off the power of the projector and unplug the power cord.
- 2 Remove the air filter cover on the bottom of the projector.

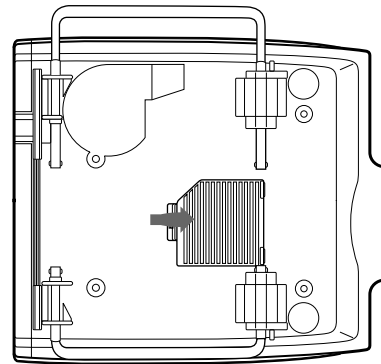

- 3 Remove the air filter.

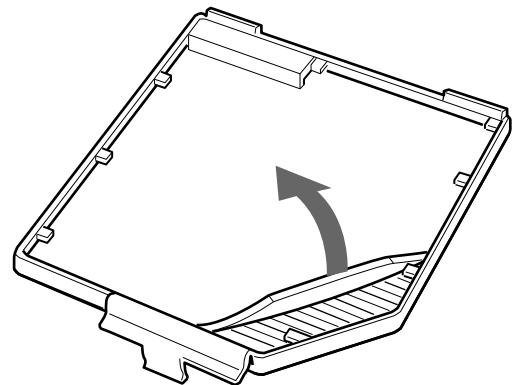

- 4 Remove the dust from the filter with a vacuum cleaner.
- 5 Attach the air filter and replace the cover.

Notes

- If the air filter is excessively dirty, wash it with mild detergent solution and dry it in a shaded place.
- Be sure to attach the air filter cover firmly; the power will not be turned on if it is not closed securely.

Troubleshooting

If the projector appears to be operating erratically, try to diagnose and correct the problem, using the following guide. If the problem still persists, consult with qualified Sony personnel.

| Symptom | Cause | Remedy |
|--|---|--|
| The power is not turned on. | The power has been turned off and on with the ON key at a short interval. | Wait for about one minute before turning on the power (<i>see page 10</i>). |
| | The lamp cover is detached. | Attach the lamp cover securely. |
| | The air filter cover is detached. | Attach the air filter cover securely (<i>see page 38</i>). |
| No picture and no sound. | Cable is disconnected. | Check that the proper connections have been made (<i>see pages 21, 32 and 33</i>). |
| | Input selection is not correct. | Select the input source correctly in the SIGNAL SELECT menu (<i>see page 31</i>). |
| No picture or no sound. | Either the picture or the sound is cut off. | Press the MUTING key to cancel the muting function (<i>see page 24</i>). |
| The picture is noisy. | Noise may appear on the background depending on the combination of the numbers of dot input from the connector and numbers of pixel on the LCD panel. | Change the desktop pattern on the connected computer. |
| The picture from INPUT A/B connector is colored strange. | Setting for INPUT-A or INPUT-B in the SIGNAL SELECT menu is incorrect. | Set INPUT-A or INPUT-B in the SIGNAL SELECT menu correctly according to the input signal (<i>see page 31</i>). |
| "Please check INPUT-A in SIGNAL SELECT" appears in spite of inputting the correct signal from INPUT A. | Setting for INPUT-A in the SIGNAL SELECT menu is incorrect. | Set INPUT-A in the SIGNAL SELECT menu correctly according to the input signal (<i>see page 31</i>). |
| "Please check INPUT-B in SIGNAL SELECT" appears in spite of inputting the correct signal from INPUT B. | Setting for INPUT-B in the SIGNAL SELECT menu is incorrect. | Set INPUT-B in the SIGNAL SELECT menu correctly according to the input signal (<i>see page 31</i>). |
| "NO INPUT" appears when 15k RGB or component signal is input. | The sync signal is incorrect. | Input the correct sync signal (composite sync or sync on G signal (sync on Y for component signal)). |
| On-screen displays do not appear. | STATUS in the SET SETTING menu is set to OFF. | Set STATUS in the SET SETTING menu to ON (<i>see page 30</i>). |
| Color balance is not correct. | Picture has not been adjusted properly. | Adjust the picture (<i>see page 26</i>). |
| | The color system of the input signal is not set correctly. | Set COLOR SYS in the PICTURE CTRL menu to match the color system of the input signal (<i>see page 26</i>). |
| The picture is too dark. | The lamp is nearing the end of its life. | Replace the lamp with a new one (<i>see page 37</i>). |
| | Contrast or brightness has not been adjusted properly. | Adjust CONTRAST or BRIGHT in the PICTURE CTRL menu properly (<i>see page 26</i>). |
| The picture is not clear. | The picture is out of focus. | Adjust the focus (<i>see page 23</i>). |
| | Moisture condensation has occurred on the lens. | Leave the projector for about two hours with the power on (<i>see page 17</i>). |
| The image from INPUT C is fixed. | Some trouble has occurred to the network. | Press the FUNCTION key and then RESET key on the Remote Commander within 5 seconds to reset the network. |



Troubleshooting

| Symptom | Cause | Remedy |
|--|---|--|
| The image from INPUT C does not appear. "NO INPUT" is displayed. | The INPUT C/RS-232C/RS-422A select switch is not set correctly. | Set the INPUT C/RS-232C/RS-422A select switch to INPUT C. |
| The PJ COM connectors do not function. | The INPUT C/RS-232C/RS-422A select switch is set to INPUT C. | Set the INPUT C/RS-232C/RS-422A select switch to RS-232C or RS-422A. |
| The mouse or keyboard does not function. | The mouse or keyboard is connected after the power of the projector is turned on. | Connect the mouse or keyboard before the power of the projector is turned on. You can use the mouse or keyboard when the INPUT C/RS-232C/RS-422A select switch is set to INPUT C and the INPUT C signal is selected. |
| The Remote Commander does not work. | The batteries are exhausted. | Replace the batteries with new ones (<i>see page 16</i>). |
| | The remote commander cable is connected to the Remote Commander although you are using it as a wireless Remote Commander. | Disconnect the remote control cable. |
| | The fluorescent lamp influences on the Remote Commander detector. | Change the setting of SIRCS RECEIVER in the SET SETTING menu (<i>see page 30</i>). |
| | You have selected a wrong index number. | Select the correct index number (<i>see pages 30 and 35</i>). |
| | You have set the index number to "00". | Select the correct index number (<i>see pages 30 and 35</i>). |
| The wireless Remote Commander does not function. | The SIRCS RECEIVER setting is not correct. | Change the setting of SIRCS RECEIVER in the SET SETTING menu (<i>see page 30</i>). |
| INPUT A cannot be selected. | The switcher is not connected, but is recognized to be connected. | If the PJ COM connector is connected to something other than the terminator, remove it then press the SYS SET key, or LIGHT and RESET keys on the control panel. |
| The COVER FAIL indicator lights. | The lamp cover or air filter cover is detached. | Attach the lamp cover or air filter cover securely (<i>see pages 37 and 38</i>). |
| The LAMP FAIL indicator lights. | The lamp with the same number of the indicator has reached the end of its life. | Replace the lamp (<i>see page 37</i>). |
| The FAN indicator lights. | The fan is broken. | Consult with qualified Sony personnel. |
| The HIGH TEMP indicator lights. | The internal temperature is unusually high. | Check to see if nothing is blocking the ventilation holes. |
| | | Clean the air filter. |
| When you press the ZOOM, SHIFT or FOCUS key, "LENS CONTROL is locked! Do you wish to unlock?" appears. | The lens control function is locked. | Consult with qualified Sony service personnel. |

Caution messages

Use the list below to check the meaning of the messages displayed on the screen.

| Message | Meaning | Remedy |
|--|--|---|
| High Temperature! Power off in 1 min. | Internal temperature becomes too high. | Turn off the power. (If not, the power is automatically turned off about one minute later.) Check to see if nothing is blocking the ventilation holes. Clean the air filter |
| Frequency is out of range! | The frequency of the input signal is out of the acceptable range. | Input a signal that is within the range of the frequency. |
| Please check INPUT-A in SIGNAL SELECT. | You have input the RGB signal from the computer when INPUT-A in the SIGNAL SELECT menu is set to COMPONENT, DTV-GBR or DTV-YP _B PR. | Set INPUT-A correctly. |
| Please check INPUT-B in SIGNAL SELECT. | You have input the RGB signal from the computer when INPUT-B in the SIGNAL SELECT menu is set to COMPONENT, VIDEO, S-VIDEO, DTV-GBR or DTV-YP _B PR. | Set INPUT-B correctly. |
| Backup Battery Very Low | The backup battery is worn out. | Consult with qualified Sony service personnel. |

Specifications

Optical characteristics

| | |
|-------------------|--|
| Projection system | 3 LCD panels, 1 lens, 3-primary color optical shutter system |
| LCD panel | 1.8-inch SXGA LCD panel, 3,932,160 pixels (1,310,720 pixels × 3) |
| Lens | Option |
| Light output | ANSI lumen ¹⁾ 4,000 lm |
| Lamp | 120 W UHP × 4 |

Electrical characteristics

| | |
|----------------------------|--|
| Color system | NTSC _{3.58} /PAL/SECAM/NTSC _{4.43} /PAL-M system, switched automatically |
| Resolution | 600 horizontal TV lines (video input) 1280 × 1024 dots (RGB input) |
| Acceptable computer signal | fH: 15 to 100 kHz fV: 40 to 120 Hz |
| Speakers | Max. 5 W, 90 × 50 mm (3 ⁵ / ₈ × 2 inches), monaural |

Input/Output

| | |
|---------------------|--|
| CONTROL S | IN/PLUG IN POWER: Stereo minijack, 5 Vp-p, plug in power, DC 5 V, maximum output 60 mA OUT: Stereo minijack, 5 Vp-p |
| REMOTE RS-232C/422A | D-sub 9-pin (female) (For details, see "Pin assignment" on page 45.) |
| PJ COM | IN: D-sub 9-pin (male) OUT: D-sub 9-pin (female) (For details, see "Pin assignment" on page 45.) |
| TRIG | Minijack Power on: DC 12 V, output impedance: 4.7 kilohms Power off: 0 V |

S VIDEO (priority to Y IN/C IN)

IN: Mini DIN 4-pin type (male)
Y (luminance): 1 Vp-p ± 2 dB sync negative, 75 ohms terminated
C (chrominance): Burst 0.286 Vp-p ± 2 dB (NTSC), 75 ohms terminated
Burst 0.3 Vp-p ± 2 dB (PAL), 75 ohms terminated
OUT: Loop-through mini DIN 4-pin type (male)
Loop-through output from the S VIDEO IN connector

Y IN: BNC type
1 Vp-p ± 2 dB sync negative, 75 ohms terminated
C IN: BNC type
Burst 0.286 Vp-p ± 2 dB (NTSC), 75 ohms terminated
Burst 0.3 Vp-p ± 2 dB (PAL), 75 ohms terminated

VIDEO

IN: BNC type
Composite video, 1 Vp-p ± 2 dB sync negative, 75 ohms terminated
OUT: Loop-through BNC type
Loop-through output from the VIDEO IN connector

AUDIO IN

Phono type (stereo)
500 mVrms, impedance more than 47 kilohms

INPUT A

Analog RGB/component: BNC type
R/R-Y: 0.7 Vp-p ± 2 dB positive, 75 ohms terminated
G: 0.7 Vp-p ± 2 dB positive, 75 ohms terminated
G with sync/Y: 1 Vp-p ± 2 dB sync negative, 75 ohms terminated
B/B-Y: 0.7 Vp-p ± 2 dB positive, 75 ohms terminated
SYNC/HD: Composite sync: 0.6–8 Vp-p, high impedance, sync positive/negative
Horizontal sync: 0.6–8 Vp-p, high impedance, sync positive/negative

1) ANSI lumen is a measuring method of American National Standard IT 7.228.

| | | |
|--------------------------|--|---|
| | VD: Vertical sync: 0.6–8 Vp-p, high impedance, sync positive/negative | |
| | AUDIO IN: Phono type (stereo) 500 m Vrms, impedance more than 47 kilohms | |
| | HDTV/DTV (YPbPr): BNC type Y: 1 Vp-p ± 2dB positive, 75 ohms terminated Tri-level sync: ± 0.3 Vp-p Bi-level sync: 0.3 Vp-p Pb/Pr: 0.35 Vp-p ± 2dB positive, 75 ohms terminated | |
| | HDTV/DTV (GBR): BNC type G with sync: 1 Vp-p ± 2 dB, 75 ohms terminated Tri-level sync: ± 0.3 Vp-p Bi-level sync: 0.3 Vp-p B/R: 0.7 Vp-p ± 2dB positive, 75 ohms terminated | |
| | <i>(For HDTV/DTV signals see “Acceptable HDTV/DTV signals” on page 45.)</i> | |
| Input C | PC card slot Type II | |
| AUDIO OUT (variable out) | Phono type, Max. 1 Vrms When input is 500 mVrms: impedance less than 5 kilohms | |
| MOUSE | Mini DIN 6-pin (female) <i>(For details, see “Pin assignment” on page 45.)</i> | |
| KEYBOARD | Mini DIN 6-pin (female) <i>(For details, see “Pin assignment” on page 45.)</i> | |
| Safety regulations | VPL-FE110U: UL1950, c-UL1950, FCC Class A, IC Class A VPL-FE110M: EN60 950 (NEMKO), CE, C-Tick | |
| | | General |
| | | Dimensions 562 × 237 × 649 mm (22 1/4 × 9 3/8 × 25 5/8 inches) (w/h/d) |
| | | Mass Approx. 34.5 kg (76 lb 1 oz) (excluding the optional lens) |
| | | Power requirements VPL-FE110U: AC 100 to 120 V/220 to 240 V, 50/60 Hz ¹⁾ VPL-FE110M: AC 220 to 240 V, 50/60 Hz |
| | | Power consumption Approx. 830 W Standby mode: 6.8W for VPL-FE110U, 12 W for VPL-FE110M (with the INPUT C/RS-232C/RS-422A set to INPUT C: 13.3 W for VPL-FE110U, 21 W for VPL-FE110M) |
| | | Heat dissipation 2833 BTU |
| | | Operating temperature 0°C to 40°C (32°F to 104°F) |
| | | Operating humidity 35% to 85% (no condensation) |
| | | Storage temperature -20°C to +60°C (-4°F to +140°F) |
| | | Storage humidity 10% to 90% |
| | | Supplied Accessories Remote Commander RM-PJ1001 (1) Size AA (R6) batteries (3) Remote commander cable (stereo) (15 m) (1) AC power cord (1) Terminator for the PJ COM connector (1) Lens ring (1) Noise prevention core (1) Operating Instructions (1) Operating Instructions for Networking (1) Installation Manual for Dealers (1) Protection Distance Chart (1) Recommended PC card/wireless LAN access point (1) CD-ROM Manual (1) Warranty Booklet (1) |

This projector is designed for business use.

Design and specifications are subject to change without notice.

(continued)

1) UL listed for 120 V operation.

Specifications

Optional accessories

Projector Lamp LMP-Q130 (for replacement)

Projector Lamp LMP-S120 (for replacement)

Interface Board

IFB-12A (Analog RGB/component/HDTV/
composite video/S video input with 5BNC type
connectors)

IFB-21 (Analog RGB input/output with HD D-sub
15-pin type connector)

IFB-50 (serial digital video input/output with BNC
type connector)

IFB-1000 (Composite video input with BNC type
connector/S video input with mini DIN 4-pin
type connector)

SIC Cable SIC-10

Monitor Cable

SMF-400 (HD D-sub 15-pin (male) ↔ 5BNC
(female))

SMF-410 (HD D-sub 15-pin (male) ↔ HD D-sub
15-pin (female))

Remote Commander RM-PJM610

Projection Lens

Fixed short focus lens VPLL-2009

Fixed short focus lens VPLL-2014

1.3-times zoom standard focus lens VPLL-Z3020

1.6-times zoom long focus lens VPLL-Z2025

1.5-times zoom long focus lens VPLL-Z2039

Fixed long focus lens VPLL-3050

Fixed long focus lens VPLL-2075

Projector Stand SU-PJ2000 (for stacking)

Projector Suspension Support PSS-2000

Screens

VPS-100FH (100-inch, flat)

VPS-120FH (120-inch, flat)

Some of the items may not be available in some areas.

For details, please consult your nearest Sony office.

Pin assignment

RS-232C/422A connector (D-sub 9-pin, female)

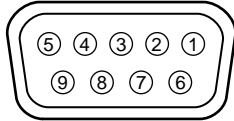

RS-232C

| | | | | | |
|---|------|---------------------|---|-------|-----------------|
| 1 | NC | | 6 | DSR* | Data Set Ready |
| 2 | RD | Receive Data | 7 | RTS** | Request to Send |
| 3 | TD | Transmit Data | 8 | CTS** | Clear to Send |
| 4 | DTR* | Data Terminal Ready | 9 | NC | |
| 5 | GND | Ground | | | |

* Circuit between pins 4 and 6 is short-circuited in the projector.

** Circuit between pins 7 and 8 is short-circuited in the projector.

RS-422A

| | | | | | |
|---|------------------------|----------|---|------------------------|----------|
| 1 | GND | Ground | 6 | GND | Ground |
| 2 | $\overline{\text{TX}}$ | Transmit | 7 | TX | Transmit |
| 3 | RX | Receive | 8 | $\overline{\text{RX}}$ | Receive |
| 4 | GND | Ground | 9 | GND | Ground |
| 5 | NC | | | | |

PJ COM connector (D-sub 9-pin, female)

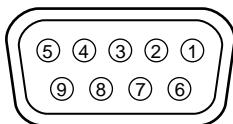

| | | | | | |
|---|--------------------------|------------------|---|---------------------------|------------------|
| 1 | GND | Ground | 6 | GND | Ground |
| 2 | $\overline{\text{BUSY}}$ | Busy | 7 | BUSY | Busy |
| 3 | TX/RX | Transmit/Receive | 8 | $\overline{\text{TX/RX}}$ | Transmit/Receive |
| 4 | GND | Ground | 9 | GND | Ground |
| 5 | NC | | | | |

KEYBOARD/MOUSE connectors (mini DIN 6-pin)

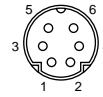

| | |
|---|-------|
| 1 | DATA |
| 2 | NC |
| 3 | GND |
| 4 | +5V |
| 5 | CLOCK |
| 6 | NC |

S VIDEO connector (mini DIN 4-pin)

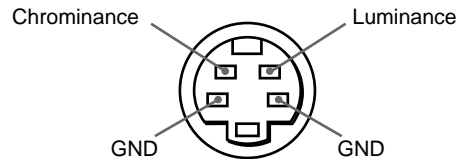

Acceptable HDTV/DTV formats

| Format | Scanning rate (kHz) | Frame rate (Hz)* | Scanning format | Aspect ratio | Standard |
|------------|---------------------|------------------|-----------------|--------------|---------------------------|
| 1035/60i | 33.75 | 30 | 2:1 interlace | 16:9 | BTA S-001B |
| 1080/60i | 33.75 | 30 | 2:1 interlace | 16:9 | SMPTE 274M/ BTA S-001B |
| 480/60P | 31.5 | 60 | Progressive | 16:9/4:3 | SMPTE 293M |
| 575/50P | 31.25 | 50 | Progressive | 16:9/4:3 | - |
| 1080/24PsF | 27 | 24 | 2:1 interlace | 16:9 | - |
| 1080/50i | 28.13 | 25 | 2:1 interlace | 16:9 | SMPTE 274M |
| 720/60P | 45 | 60 | Progressive | 16:9 | SMPTE 293M |
| 720/50P | 37.5 | 60 | Progressive | 16:9 | - |

* Each of the frame rates is also compatible with 1/1.001.

A

Adjusters 9
Adjusting

- picture 26
- picture size/shift 27
- zoom 23

Air filter 38
ASPECT 27
AUDIO MUTING 24

B

Battery

- Installation 16
- notes 16

BLANKING 27
BNC connector 32
BRIGHT 26

C

Carrying handles 9
Caution messages 40
COLOR 26
COLOR SYS (System) 26
COLOR TEMP 26
Connecting to LAN 19
Connections

- active speakers 21
- BNC connector 32
- computer 21
- 15k RGB/component equipment 32
- LAN 19
- Remote Commander 16
- switcher 33
- VCR 21

CONTRAST 26
Cut off

- the picture 24
- the sound 24

D, E

D. (Dynamic) PICTURE 26
Device index 30, 35
DOT PHASE 27
DRC (Digital Reality Creation) 7

F

fH (Horizontal frequency) 29
FOCUS 23
fV (Vertical frequency) 29

G

GAMMA MODE 26
Group index 30, 35

H

Handle lever 9
H FILTER 27
HUE 26

I, J, K

INPUT-A 31
INPUT-B 31
INPUT MEMORY No. 28
INPUT SETTING menu 27
Input signal selection 22
Installation on a floor 18

L

Lamp replacement 37
LANGUAGE 30
Location and function of controls

- control panel 10
- front 8
- rear 12
- Remote Commander 14

M, N

Memory card 20
Menu

- Clearing the menu display 25
- INPUT SETTING menu 27
- PICTURE CTRL menu 26
- SET SETTING menu 30
- SIGNAL SELECT menu 31
- Using the menu 25

Moisture condensation 17

O

On-screen display 30
On-screen messages 40
Optional accessories 42

P, Q

PC-3000 Signal Interface Switcher 33
PC card 19
PIC MUTING 24

PICTURE CTRL menu 26
PICTURE SHIFT 24
Pin assignment 43
PJ COM connector 33
Power

- turn off 24
- turn on 22

POWER SAVING 30
Precautions 6
Precautions on installation 17
Projecting 22

R

Remote Commander

- battery installation 16
- connecting to the projector 16
- location and function of controls 14
- notes 16

Remote control (SIRCS) detector

- front 8
- rear 11

Reset

- resetting the item 25
- resetting the Windows CE 15

RS-232C/422A connector 13

S

SCAN CONV 27
SET SETTING menu 30
SHARP 26
SHIFT 27
SIGNAL SELECT menu 31
SIRCS RECEIVER 30
SIZE 27
Slot 19
SPEAKER 30
Specifications 41
STATUS 30
Supplied accessories 42

T, U, V, W, X, Y

Troubleshooting 39

Z

ZOOM 23

