

Stereo Cassette Deck

Operating Instructions

TC-WE835S
TC-WE635

Warning

To prevent fire or shock hazard, do not expose the unit to rain or moisture.

NOTICE FOR THE CUSTOMERS IN THE U.S.A.

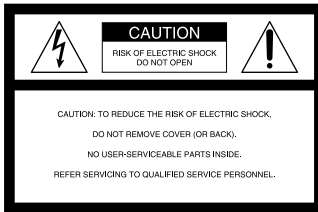

This symbol is intended to alert the user to the presence of uninsulated “dangerous voltage” within the product’s enclosure that may be of sufficient magnitude to constitute a risk of electric shock to persons.



This symbol is intended to alert the user to the presence of important operating and maintenance (servicing) instructions in the literature accompanying the appliance.

Owner’s Record

The model and serial numbers are located on the rear panel of the unit. Record the serial number in the space provided below. Refer to them whenever you call upon your Sony dealer regarding this product.

Model No. _____
Serial No. _____

INFORMATION

This equipment has been tested and found to comply with the limits for a Class B digital device, pursuant to Part 15 of the FCC Rules. These limits are designed to provide reasonable protection against harmful interference in a residential installation. This equipment generates, uses, and can radiate radio frequency energy and, if not installed and used in accordance with the instructions, may cause harmful interference to radio communications. However, there is no guarantee that interference will not occur in a particular installation. If this equipment does cause harmful interference to radio or television reception, which can be determined by turning the equipment off and on, the user is encouraged to try to correct the interference by one or more of the following measures:

- Reorient or relocate the receiving antenna.
- Increase the separation between the equipment and receiver.
- Connect the equipment into an outlet on a circuit different from that to which the receiver is connected.
- Consult the dealer or an experienced radio/TV technician for help.

CAUTION

You are cautioned that any changes or modification not expressly approved in this manual could void your authority to operate this equipment.

NOTICE FOR THE CUSTOMERS IN CANADA

CAUTION

TO PREVENT ELECTRIC SHOCK, DO NOT USE THIS POLARIZED AC PLUG WITH AN EXTENSION CORD, RECEPTACLE OR OTHER OUTLET UNLESS THE BLADES CAN BE FULLY INSERTED TO PREVENT BLADE EXPOSURE.



A946

Welcome!

Thank you for purchasing the Sony Stereo Cassette Deck. Before operating the unit, please read this manual thoroughly and retain it for future reference.

About This Manual

The instructions in this manual are for models TC-WE835S and WE635. Check your model number by looking at the rear panel of your tape deck. In this manual, the TC-WE835S is the model used for illustration purposes. Any difference in operation is clearly indicated in the text, for example, “TC-WE835S only.”

Differences between the models

The two models covered by this manual differ with respect to the features shown in the table below. Check the table to verify whether the features are available on your tape deck before you start operating it.

	Model WE835S	WE635
High-speed Fast-forwarding and Rewinding	•	
Dolby S	•	

The power switch

The power switch is different, depending on the model and the place you purchased the tape deck.

Where purchased The power switch

U.S.A. and Canada I/O*

Other countries ①

* ① for the TC-WE635 U.S.A. and Canadian models.

Convention

- Instructions in this manual describe the controls on the cassette deck. You can also use the controls on the optional remote (supplied for TC-WE835S U.S.A. model only) if they have the same or similar names as those on the deck.
- The following icons are used in this manual:



Indicates a task that requires use of the remote.



Indicates hints and tips for making the task easier.

TABLE OF CONTENTS

Getting Started

- Unpacking 4
 - Hooking Up the System 4
-

Playing a Tape 5

Recording on a Tape 6

Advanced Playback Operations

- Locating a Track (Multi-AMS/Auto Play/Memory Play) 8
 - Creating Your Own Program (RMS Play) 9
-

Advanced Recording Operations

- Adjusting Bias and Recording Level Calibration Automatically 11
 - Adjusting the Recording Level Automatically (Auto Rec Level) 12
 - Fading In and Out (Fader) 13
 - Dubbing a Tape 13
 - Recording on Both Decks in Succession (Relay Recording) 14
 - Recording the Same Source on Both Decks (Simultaneous Recording) 15
 - Recording Your Own Program (RMS Dubbing) 15
 - Inserting a Blank Space During Recording (Record Muting) 16
 - Syncro-recording With a CD Player Through a Control A1 Cord 16
 - Syncro-recording With a CD Player Using a Remote 17
-

Additional Information

- Precautions 18
 - Notes on Cassette Tapes 18
 - Cleaning 19
 - Troubleshooting 20
 - Specifications 21
 - Glossary 22
-

Index 22

Unpacking

Check that you received the following items:

- Audio connecting cords (2)
- Remote commander (remote) RM-J910 (1)*
- Sony R6 (size AA) batteries (2)*
- Control A1 cord (1)**

* Supplied for TC-WE835S U.S.A. model only

** Supplied for Canadian models only

Inserting batteries into the remote (TC-WE835S U.S.A. model only)

Insert two R6 (size-AA) batteries, matching the + and - on the batteries with the markings inside the battery compartment. When using the remote, point it at the remote control sensor  on the tape deck.

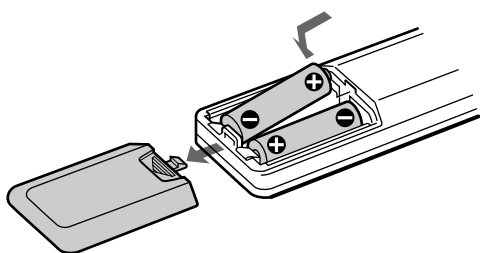

Hooking Up the System

This section describes how to hook up the tape deck to an amplifier or a CD player equipped with CONTROL A1 connectors. Be sure to turn off the power of each component before making the connections.

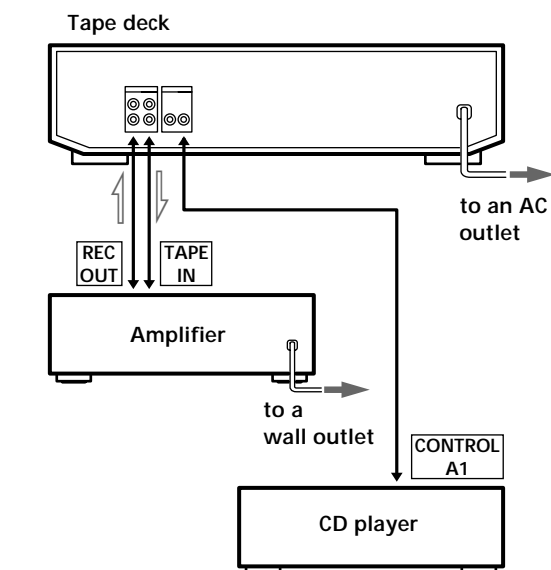

→: Signal flow

Hookups

- Connecting the tape deck to an amplifier
Connect the amplifier to the LINE IN/OUT connectors using the supplied audio connecting cords. When connecting an audio connecting cord, be sure to match the color-coded cord to the appropriate jacks on the components: Red (right) to Red and White (left) to White. Be sure to make connections firmly to avoid hum and noise.

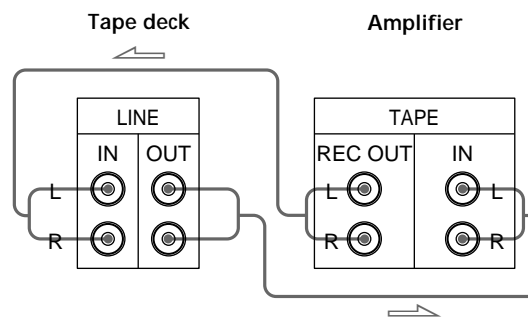

→: Signal flow

- Connecting the tape deck to a CD player equipped with CONTROL A1 connectors
For information on connections through the CONTROL A1 connectors, refer to the pamphlet included with this manual.

Setting the voltage selector (only on models supplied with a voltage selector)

Check that the voltage selector on the rear panel of the tape deck is set to the local power line voltage. If not, set the selector to the correct position using a screwdriver before connecting the AC power cord to an AC outlet.

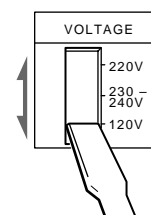

Connecting the AC power cord

Connect the AC power cord to an AC outlet.

Where do I go next?

Now you're ready to use your tape deck.

For basic operations, go to pages 5 to 7; for advanced operations, go to the sections starting from page 8.

Playing a Tape

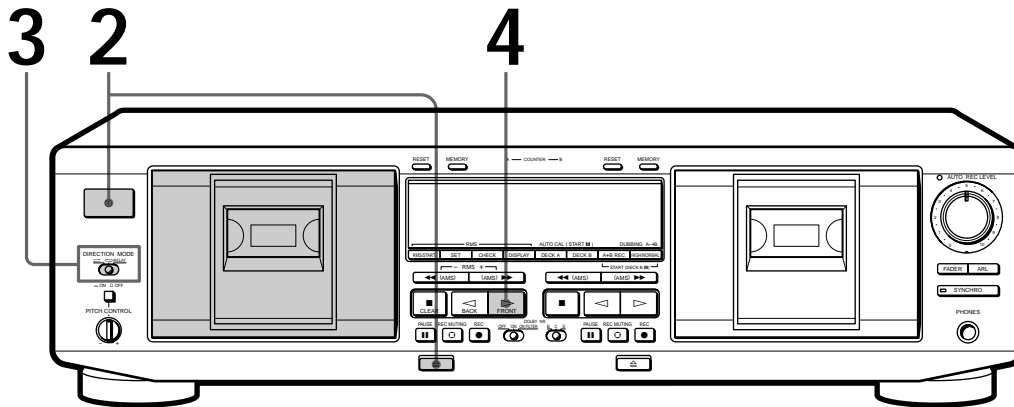

- See page 4 for hookup information.
- You can use either deck for playback.

To adjust the pitch (Pitch Control function)



Push in the PITCH CONTROL button to activate the Pitch Control function and turn the control clockwise to raise the pitch or counterclockwise to lower it. You can adjust the pitch during playback on deck A or normal-speed dubbing (but not during RMS play or RMS dubbing).

To play a tape recorded with the Dolby* NR Set DOLBY NR to ON and select the same position that the tape was recorded in—B, C, or S (TC-WE835S only).

You can connect the headphones to the PHONES jack

* “DOLBY”, the double-D symbol and “HX Pro” are trademarks of Dolby Laboratories Licensing Corporation.

1 Turn on the amplifier and select the tape deck position.

2 Press (or I/⏻), and press fully to open the cassette holder, then insert a cassette.

With the side you want to play facing you

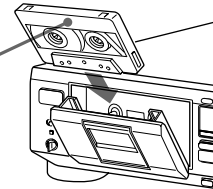

3 Set DIRECTION MODE.

To play back	Set to
One side only	
Both sides continuously*	
Both decks in succession*	RELAY

* The deck automatically stops after playing back five times.

4 Press . The deck starts playing. Adjust the volume on the amplifier.

Do not press (or I/⏻) or while the tape deck is operating. If you do so, the tape may be damaged.

To	Press
Stop playing	
Start playback from the reverse side	
Pause	PAUSE . Press the button again to resume play.
Fast-forward or rewind	or when the deck is stopped
Increase the tape fast-forward or rewind speed (High-speed Fast-forwarding and Rewinding functions) (TC-WE835S only)	or again during fast-forwarding or rewinding
Take out the cassette	after stopping playing

Recording on a Tape

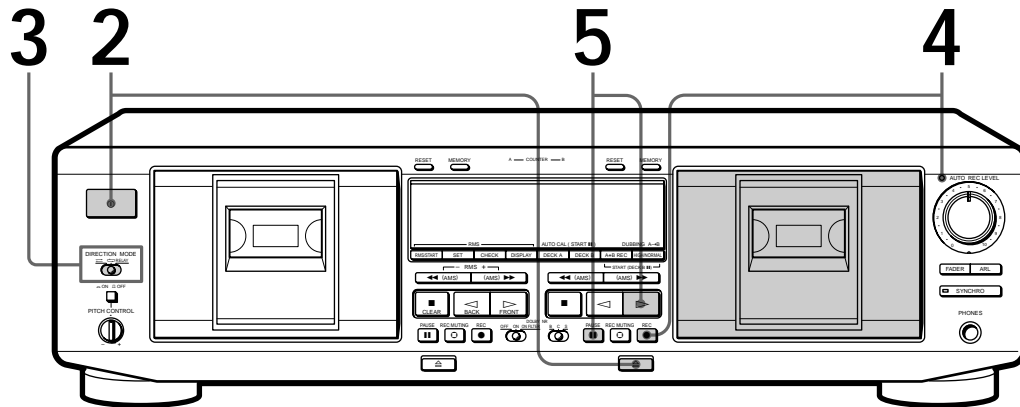

- See page 4 for hookup information.
- You can use either deck for recording.
- See “Dubbing a Tape” (page 13) to make a copy of the tape.

To check the approximate remaining time on a tape (TC-WE835S only)

- 1 Locate the end of the recorded portion on the tape and press RESET for the deck you’re using to reset the tape counter to “0.00”.
- 2 Press **▶▶** to fast-forward the tape to its end. The tape counter shows the approximate remaining time.

Note

Since the counter is not a digital clock, the displayed value will differ slightly from the actual elapsed recording or playing time.

1 Turn on the amplifier and play the program source you want to record.

2 Press **⏏** (or **I/⏏**), and press **⊞** fully to open the cassette holder, then insert a cassette.

With the side you want to record facing you

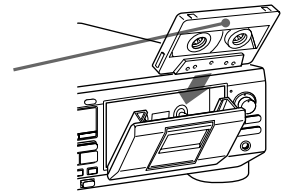

3 Set DIRECTION MODE.

To record on	Set to
Only one side	⇄
Both sides*	↻

* Recording stops when the tape reaches the end of reverse side.

4 Press REC ●.

▷ lights up for recording on the side facing you. If it doesn’t, press **▷** once.

The tape deck automatically adjusts the recording level (see page 12). After the AUTO indicator lights up continuously, stop playing the program source. If you wish to adjust the recording level manually, see “To adjust the recording level manually” on page 7.

Do not press **⏏** (or **I/⏏**) or **⊞** while the tape deck is operating. If you do so, the tape may be damaged.

 To protect recordings against accidental erasure Break out the record-protect tab(s) (see page 18).

5 Press PAUSE **||** or **▷**.
Recording starts.

6 Start playing the program source.

To	Press
Stop recording	■
Start recording from the reverse side	◁ twice in Step 5
Pause	PAUSE . Press the button again to resume recording.
Take out the cassette	⏏ after stopping recording

 The Dolby HX Pro* automatically works during recording. Distortion and noise in the high-frequency response are reduced to produce high-quality sound that can be enjoyed even during playback on other tape decks.

Use the following selectors and control to perform additional operations

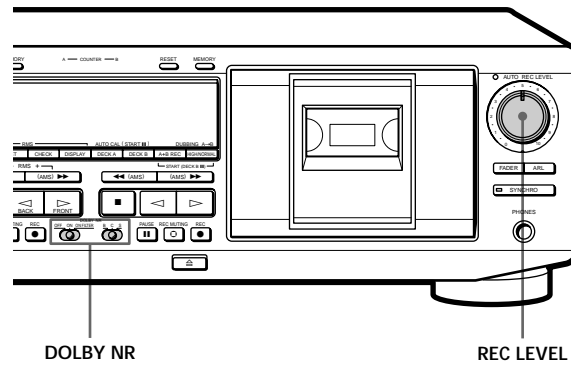

To record with the Dolby NR

Set DOLBY NR to ON, and select B, C, or S (TC-WE835S only) before you start recording.

To record FM broadcasts with the Dolby NR

If the FM reception is unsatisfactory, set DOLBY NR to ON FILTER (multiplex filter) (see page 22).

To adjust the recording level manually

After pressing REC **●** in Step 4 on page 6, turn REC LEVEL so that the peak level meters reach the recommended level for the corresponding tape type. After completing the adjustments, stop playing the program source, then continue the procedure from Step 5.

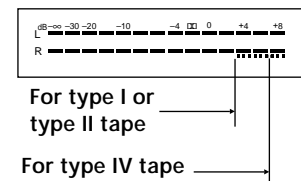

Note

Even after adjusting the recording level, distortion may occur depending on the source that you're recording from. If this happens, turn REC LEVEL counterclockwise to lower the level.

* HX Pro headroom extension originated by Bang & Olufsen and manufactured under license from Dolby Laboratories Licensing Corporation.

“DOLBY”, the double-D symbol  and “HX Pro” are trademarks of Dolby Laboratories Licensing Corporation.

Locating a Track (Multi-AMS/ Auto Play/Memory Play)

You can locate the following/previous tracks within a range of 30 tracks (Multi-AMS: Automatic Music Sensor) or the beginning of a tape quickly (Auto Play). You can even locate a specific point anywhere on a tape (Memory Play).

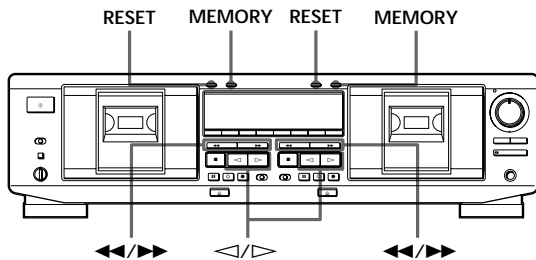

Note

Check the direction indicator of the deck you use. When you locate a track on the reverse side (when \triangleleft lights up), press the button(s) in the parentheses.

To locate	Press
The beginning of the next or succeeding tracks (Multi-AMS)	$\blacktriangleright\blacktriangleright$ (or $\blacktriangleleft\blacktriangleleft$) as many times as you want during playback. For example, to locate 2 tracks ahead, press twice.
The beginning of the current track (Multi-AMS)	$\blacktriangleleft\blacktriangleleft$ (or $\blacktriangleright\blacktriangleright$) once during playback.
The beginning of the preceding tracks (Multi-AMS)	$\blacktriangleleft\blacktriangleleft$ (or $\blacktriangleright\blacktriangleright$) as many times as you want during playback. For example, to locate 2 tracks behind, press three times.
The beginning of a tape (Auto Play)	MEMORY on the deck being used repeatedly until "M" disappears in the display. Then press $\blacktriangleleft\blacktriangleleft$ (or $\blacktriangleright\blacktriangleright$) while holding down \blacktriangleright (or \blacktriangleleft).
A particular point on a tape (Memory Play)	MEMORY on the deck being used repeatedly until "M" appears in the display. Find the point you want, then press RESET to reset the tape counter and to memorize the point. To locate the memorized point and start playback, press $\blacktriangleleft\blacktriangleleft$ (or $\blacktriangleright\blacktriangleright$) while holding down \blacktriangleright (or \blacktriangleleft). (Press $\blacktriangleleft\blacktriangleleft$ or $\blacktriangleright\blacktriangleright$ to stop at "0.00" (TC-WE835S only) or at "0000" (TC-WE635 only).)

Notes

- The Multi-AMS function may not work correctly if:
 - the blank space between tracks is less than 4 seconds long.
 - there is a passage of low frequencies or very low volume within a track.
 - the signal strength of the left and right channels are very different.
- The Multi-AMS function is inoperative on a deck whenever the other deck is playing, recording (except during dubbing), or in pause.
- Even if the DIRECTION MODE selector is set to \curvearrowright , the deck stops when the current side reaches the end during Multi-AMS operation.
- The tape counters are reset to "0.00" (TC-WE835S only) or to "0000" (TC-WE635 only) when you turn off the tape deck.

Creating Your Own Program (RMS Play)

By creating a program, you can play back tracks on deck A in any order that you want. The Random Music Sensor (RMS) function lets you create a program of up to 28 tracks, from the 1st to the 14th tracks on each side of the tape.

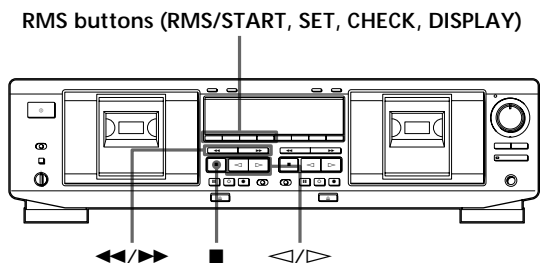

- 1 Press RMS/START. "RMS" and a flashing cursor appear in the display.
- 2 Press ◀ (BACK) or ▶ (FRONT) to select the side of the tape. ◀ or ▶ appears in the display.
- 3 Press ◀◀ or ▶▶ repeatedly until the track number you want appears in the display.

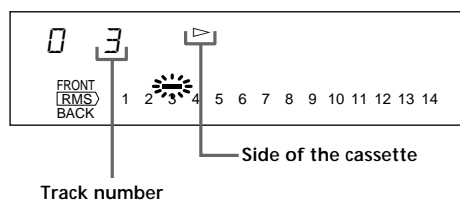

- 4 Press SET to store your selection. To program the same track again, press SET once more.

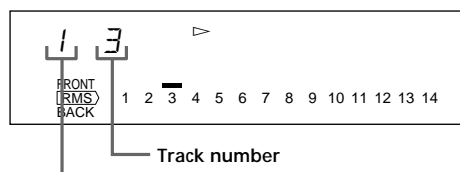

- 5 Repeat Steps 2 to 4 to program more tracks.

If "FULL" appears in the display

This means that you've already programmed 28 tracks and can't program any more.

- 6 Press RMS/START to start RMS Play. The peak level meters appear in the display.

To stop RMS Play

Press ■ (CLEAR) once. The RMS program still remains.

To cancel RMS Play

Press ■ (CLEAR) repeatedly until the peak level meters appear in the display or eject the tape in deck A. When RMS Play is canceled, the RMS program is automatically erased.

To alternate between the RMS and peak level meter displays

Press DISPLAY.

You can play the program again after RMS Play ends. Press RMS/START.

Notes

- During RMS Play, you can only use the CHECK, DISPLAY, and ■ buttons on deck A, and the ■, ◀◀, and ▶▶ buttons on deck B.
- The RMS function may not work properly if a blank space between tracks is short.
- If there is a long blank space between tracks, the deck may fast-forward a portion of the blank space.
- If your program includes a number for a track that does not exist, the deck will skip that number during RMS Play.

Checking the order of tracks in the program

Press CHECK.

Each time you press this button, the display shows the track numbers in the order they were programmed. After the last track in the program, "End" appears in the display.

(Continued)

Adding tracks to the end of a program

Press ■ (CLEAR) once, and follow Steps 2 to 5 in “Creating Your Own Program (RMS Play)” on page 9.



To create another program

Press ■ (CLEAR) until the order on the program returns to 0 and the cursor flashes above track number 1 in the display, then follow Steps 2 to 5 on page 9.



You can use your Sony remote to perform RMS programming

If your Sony stereo receiver's remote has RMS buttons, do the following steps.

- 1 Turn on the receiver and press TAPE.
- 2 Press RMS/START.
- 3 Press ▷ or ◁ to select the front or reverse side of the tape, and the number keys and the >10 key to specify the tracks.
- 4 Press RMS/START again to start RMS Play.

Note

For more information on the availability of Sony stereo receiver remotes with RMS capability, contact your nearest Sony dealer.

Adjusting Bias and Recording Level Calibration Automatically

Since there are many different types of cassettes on the market, your tape deck automatically sets the appropriate equalization characteristics and bias current for each tape type (ATS: Automatic Tape Selection). However, you can get better recording results by doing the automatic bias current and the recording level calibration.

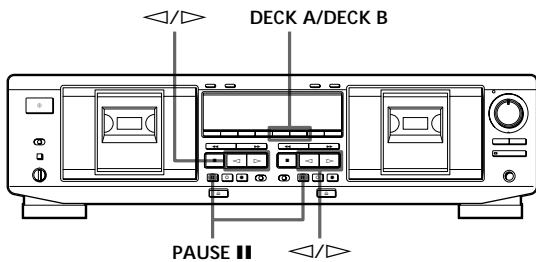

- 1 Insert the cassette you want to record on into either deck.
Make sure the record-protect tabs on the cassette have not been removed.
- 2 Press DECK A or DECK B until "CAL" appears in the display.
- 3 Press \triangleright or \triangleleft to select the side of the tape to be recorded.

To select	Press
The front side	\triangleright
The reverse side	\triangleleft

- 4 Press PAUSE ■ .
The automatic calibration procedure starts (i.e., recording test tones, rewinding, and playing back).
During the calibration, the counter changes from 9 to 0.

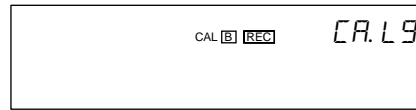

When the automatic calibration procedure ends, the tape rewinds to the original position, the counter returns to normal and the tape deck stops.

- 5 Start the actual recording (see page 6).

To cancel the Automatic Calibration function
Press ■ on the deck you're using.

If "[A]" or "[B]" flashes continuously

The automatic calibration procedure has been interrupted by:

- The end of the tape. Reverse the tape direction or rewind the tape to a new position that allows recording of the test tone.
- Damaged tape or dirty heads. Change the cassette or clean and demagnetize the heads (see page 19).

Updating the calibration setting

If you insert a cassette and "[A] CAL" or "CAL [B]" appears in the display, it means that automatic calibration data in that deck for that tape type (I, II or IV) exists. However, we recommend that you repeat the automatic calibration procedure each time you insert a new cassette since cassettes of the same type also vary in their characteristics.

Before recalibrating, be sure to turn off "[A] CAL" or "CAL [B]" by pressing the DECK A or DECK B button. Then start from Step 2 of the automatic calibration procedure.

Adjusting the Recording Level Automatically (Auto Rec Level)

The Auto Rec Level function automatically measures the peak signal level and adjusts the recording level accordingly. The Auto Rec Level function operates during normal recording, Relay Recording or Simultaneous Recording on either deck.

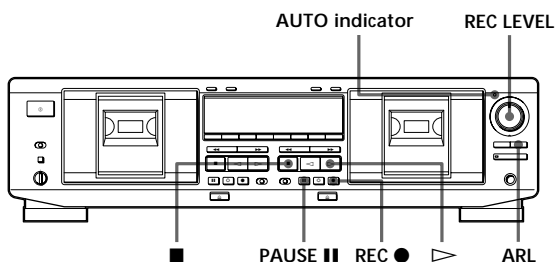

- 1 Follow Steps 1 to 3 of “Recording on a Tape” on page 6.
Make sure that record-protect tabs on the cassette have not been removed.
- 2 Press REC ●.
The AUTO indicator flashes and the deck automatically adjusts the recording level. The AUTO indicator lights up continuously after the recording level has been adjusted.
- 3 Press PAUSE ■■ or ▷.
Recording starts.

To cancel the Auto Rec Level function

Press ARL or turn REC LEVEL to turn off the AUTO indicator. If you do either of these during recording, recording will continue but with the Auto Rec Level function turned off.

To stop recording

Press ■.

💡 How the Auto Rec Level function adjusts the recording level

While the AUTO indicator is flashing, the deck sets the recording level as high as possible without causing distortion. If the signal level rises excessively after the start of recording, the deck gradually decreases the recording level.

💡 You should adjust the recording level manually with the REC LEVEL control in the following cases:

- The recording level cannot be adjusted properly due to excessive noise in the program source.
- The program source level is too low and the recording level does not increase.
During a quiet passage in a program source such as classical music, the recording level may not increase for some time. If a high sound level is expected later on in the track, play that portion first so that the right adjustment can be obtained.
- The recording level does not decrease for a long time. The Auto Rec Level function may not work properly when you try to record sound produced by a graphic equalizer that has extremely high-level signals.

💡 To record with the optimum recording level

- To prevent changes in the recording level after recording starts, press REC ● while playing the highest sound level portion of the program source to be recorded. The result is a more natural-sounding recording.
- If you play the entire program source after the AUTO indicator has stopped flashing and is lit continuously, the deck will set the recording level for the portion of the program source with the highest signal level.

💡 Recording level setting remains even after the recording has ended

After you have finished recording with the Auto Rec Level function, the AUTO indicator remains on and the recording level setting remains the same. To cancel the setting, do one of the following:

- Press ARL to turn off the AUTO indicator
- Turn REC LEVEL
- Turn the deck off.

Fading In and Out (Fader)

You can gradually increase the recording level at the beginning of a recording (fade in) or gradually decrease the recording level at the end of a recording (fade out).

It is convenient to use this function, for example, when the tape reaches to its end and you don't want the track to be cut off abruptly.

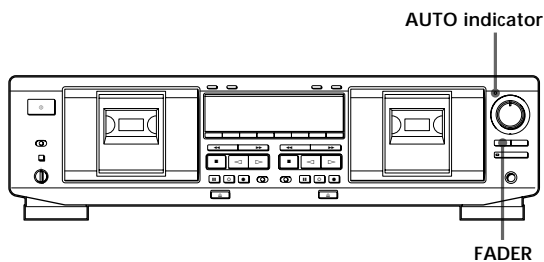

To	Do the following:
Fade in	<ol style="list-style-type: none"> Follow Steps 1 to 4 of "Recording on a Tape" on page 6. Start playing the program source and press FADER at the point where you want the fade-in to start. During fade-in, the AUTO indicator flashes. When the fade-in has completed, the AUTO indicator lights up if the Auto Rec Level function is working, or goes off if the Auto Rec Level function is not working.
Fade out	While you're still recording, press FADER at the point where you want the fade-out to start. When the fade-out has completed, "REC" flashes in the display and the deck pauses.

Note

Fade-in or fade-out is not possible when the REC LEVEL control is manually set to 0 (minimum) (see page 7).

Dubbing a Tape

You can copy a tape in deck A to a tape in deck B at normal or high speed.

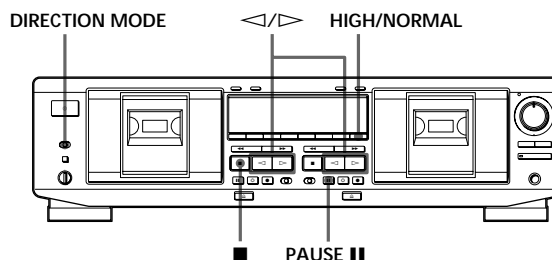

- 1 Insert a recorded cassette into deck A and a blank cassette into deck B. Make sure the record-protect tabs on the cassette in deck B have not been removed.

- 2 Select the side(s) to be recorded on.

To record on	Set DIRECTION MODE to
One side	↔
Both sides	 Recording on the reverse side on deck B starts independently of playback on deck A. RELAY. Recording on the reverse side on deck B starts simultaneously with playback of the reverse side on deck A.

- 3 Select the dubbing speed.

To select	Press HIGH/NORMAL
Normal speed	Once
High speed	Twice

"HIGH" or "NORM" appears in the display. The deck changes to dubbing standby.

- 4 Select the side from which to start dubbing.

To record from	Press
The front side	▷
The reverse side	◁

- 5 Press PAUSE ■■ on deck B to start dubbing.

(Continued)

To stop dubbing

During	Press
Normal-speed dubbing	■ on deck B
High-speed dubbing	■ on either deck

 **During high-speed dubbing**
Only the ■ button is operative.

 **You don't have to adjust the recording level or select the Dolby NR during dubbing**
Dubbing is automatically performed with the same recording level and Dolby NR as the original in deck A. If, however, you want to monitor the sound during normal-speed dubbing, set the DOLBY NR selector to match the tape in deck A (see page 5).

 **You can adjust the pitch of the playback on deck A**
See page 5.

Note

If a TV set is placed near the tape deck, noise may occur during high-speed dubbing. In that case, turn the television set off or move it away from the tape deck.

Dubbing only specific portions

You can do this only during the normal-speed dubbing.

- 1 Press ■ on deck A at the portion you want to skip.
Deck B changes to recording pause.
- 2 Locate the point you want to resume recording on deck A, then stop the tape.
- 3 Press PAUSE ■■ on deck B to resume dubbing.

Recording on Both Decks in Succession (Relay Recording)

You can make a continuous recording that starts on a cassette in deck A and ends on a cassette in deck B.

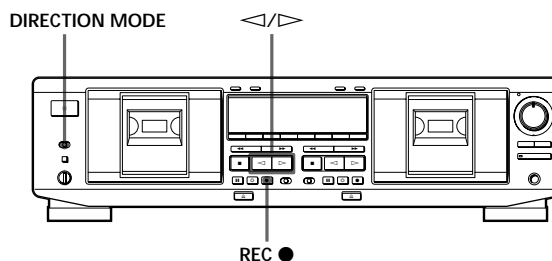

- 1 Insert blank cassettes into both decks.
Make sure that record-protect tabs on the cassettes have not been removed.
- 2 Select the Dolby NR (see page 7).
- 3 Set DIRECTION MODE to RELAY.
- 4 Press REC ● on deck A.
Deck A changes to recording pause.
- 5 Start playing the program source.
- 6 Adjust the recording level manually, if necessary (see page 7).
- 7 Start recording.

To record from	Press
The front side	▷ on deck A
The reverse side	◁ on deck A

To stop Relay Recording

During	Press
Recording on deck A	■ on deck A
Recording on deck B	■ on deck B

Note

Make sure that ▷ on deck B appears in the display. If it doesn't, press ▷ on deck B once; otherwise, Relay Recording stops when the reverse side of the cassette in deck B finishes.

Recording the Same Source on Both Decks (Simultaneous Recording)

You can record the same source on cassettes in deck A and B at the same time.

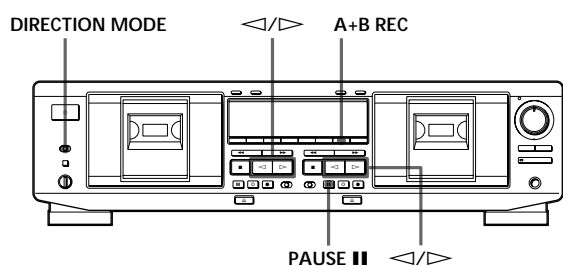

1 Insert blank cassettes into both decks. Make sure that record-protect tabs on the cassettes have not been removed.

2 Select the Dolby NR (see page 7).

3 Select the side(s) to be recorded on.

To record on	Set DIRECTION MODE to
Only one side	⇄
Both sides	↻

4 Press A+B REC. Both decks change to recording pause.

5 Start playing the program source.

6 Adjust the recording level manually, if necessary (see page 7).

7 Select the side you want to start recording from on both decks.

To record from	Press
The front side	▷
The reverse side	◁

8 Press PAUSE II on deck B. Simultaneous Recording starts.

To stop Simultaneous Recording

Press ■ on both decks.

💡 The PAUSE II and REC MUTING ○ (see page 16) buttons on deck B can control both decks at the same time. During Simultaneous Recording, the PAUSE II and REC MUTING ○ buttons on deck B control both decks, but not the PAUSE II and REC MUTING ○ buttons on deck A.

Recording Your Own Program (RMS Dubbing)

You can record an RMS program that you've created (see "Creating Your Own Program (RMS Play)" on page 9). This function works only at normal speed.

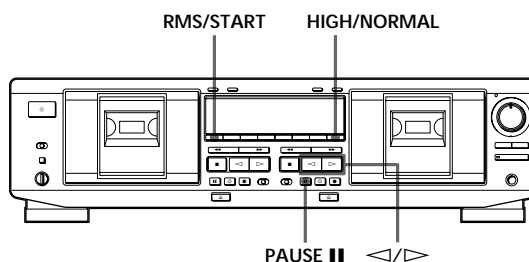

1 Insert a recorded cassette into deck A and a blank cassette into deck B. Make sure the record-protect tabs on the cassette in deck B have not been removed.

2 Program tracks on deck A (see Steps 1 to 5 on page 9).

3 Press HIGH/NORMAL once to change the tape deck to dubbing standby.

4 Select the side of the tape in deck B you want to record on.

To start recording	Press
On the front side	▷
On the reverse side	◁

5 Press RMS/START or PAUSE II on deck B to start RMS Dubbing.

To stop RMS Dubbing

Press ■ on deck B. The RMS program remains even after RMS Dubbing stops.

💡 To insert a blank space on the tape before you start RMS Dubbing. You can insert a blank space of 4 seconds or more on the tape in deck B by pressing the REC MUTING ○ button after Step 4. For details, see "Inserting a Blank Space During Recording (Record Muting)" on page 16.

💡 A blank of 10 seconds is automatically inserted on the tape when you start RMS Dubbing if:

- you insert a new cassette into deck B.
- the tape in deck B is completely rewound to its beginning and automatically stopped.

Inserting a Blank Space During Recording (Record Muting)

You can insert a blank space of 4 seconds between the tracks. The blank spaces allow you to locate the start of specific tracks afterwards using the Multi-AMS function (see page 8). You can also use this function to erase unwanted portions on a tape.

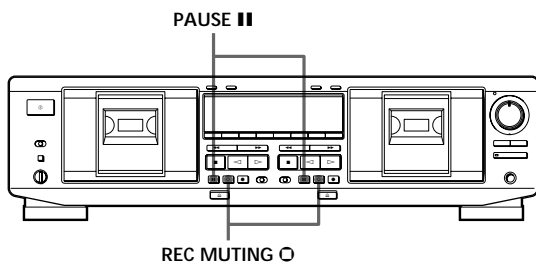

- 1 Follow Steps 1 to 5 of “Recording on a Tape” on pages 6 and 7. Recording starts.
- 2 Press REC MUTING where you want to insert a blank space. “REC” flashes in the display and a blank is recorded on the tape. After 4 seconds, lights up and the tape deck changes to recording pause.
- 3 Press PAUSE to resume recording.

If you want to insert a blank space longer than 4 seconds
 Hold down REC MUTING as long as you want. After 4 seconds, “REC” flashes faster. When you release REC MUTING , lights up and the tape deck changes to recording pause. Press PAUSE to resume recording.

Synchro-recording With a CD Player Through a Control A1 Cord

By pressing the SYNCHRO button, you can perform synchro-recording on your tape deck with a Sony CD player connected to the CONTROL A1 connector through a Control A1 cord (see page 4). The Control A1 cord supports advanced functions not possible with the commander-based CD synchro-recording function on previous models. Further information on the various operations made possible by a Control A1 cord is provided in the pamphlet attached to this manual.

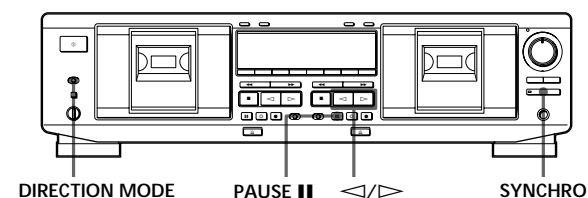

- 1 Set the source selector on the amplifier to CD player.
- 2 Insert a CD into the CD player.
- 3 Select the play mode (CONTINUE, SHUFFLE, or PROGRAM) of the CD player.
- 4 Insert a cassette into deck B.
- 5 Select the side(s) to be recorded on.

To record on	Set DIRECTION MODE to
Only one side	
Both sides	or RELAY

- 6 Select the side you want to start recording from on deck B.

To record from	Press
The front side	
The reverse side	

- 7 Press SYNCHRO.

If your CD player has the Peak Search function
 The SYNCHRO button indicator lights up and the CD player locates the highest signal level among the tracks to be recorded as the tape deck adjusts the recording level. When the recording level adjustment is completed, CD Synchro-recording starts.

If your CD player does not have the Peak Search function

The CD player changes to play pause and deck B to recording pause. Press PAUSE **||** on deck B to start Synchro-Recording.

To stop CD Synchro-recording

Press **■** on deck B or the CD player.

💡 You can use an optional remote (supplied for TC-WE835S U.S.A. model only) to operate the CD player. To start CD play, press **||** twice; to pause CD play, press **||** once; to locate a CD track, press **◀◀** or **▶▶**.

💡 If the SYNCHRO button indicator goes off after flashing rapidly

The tape cannot be recorded on because the record-protect tab(s) on the cassette has (have) been removed.

💡 Length of tape used for recording

Tracks on a CD differ in length. Classical music CDs and others often have tracks that exceed the recording time of a single cassette side. In this case, record the tape manually.

💡 When recording from the middle of the tape

A tape that is inserted and has not been played or recorded on is assumed by the deck to be a new tape, even if the present location is in the middle of the tape. The deck will transport the tape for 10 seconds before starting CD Synchro-recording to bypass the portion corresponding with the leader. To begin CD Synchro-recording without the ten-seconds delay, play or record on the tape for about 10 seconds before starting the CD Synchro-recording procedure.

💡 If the tape ends during CD Synchro-recording on the front side of the tape (**▷** lights up) and the DIRECTION MODE selector is set to **↺** or RELAY

Recording of the track ends immediately, the tape direction is reversed, and recording starts again from the beginning of the track. If the tape ends on the reverse side of the tape (**◁** lights up), CD Synchro-recording stops and the CD player stops playing.

Notes

- To prevent interruption of the recording process, do not press any operation buttons on the CD player during CD Synchro-recording.
- Certain operation buttons on the tape deck are disabled during CD Synchro-recording.

Synchro-recording With a CD Player Using a Remote

By pressing the START button on the optional remote RM-J910 (supplied for TC-WE835S U.S.A. model only), you can perform Synchro-recording on your tape deck with a Sony CD player. This function is possible only with Sony CD players with remote control capability.

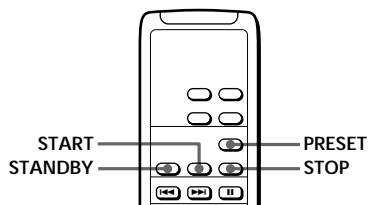

- 1 Set the source selector on the amplifier to CD player.
- 2 Insert a CD into the CD player and select the play mode (CONTINUE, SHUFFLE, or PROGRAM) of the CD player.
- 3 Insert a cassette into deck B and select the side(s) to be recorded.

To record on	Set DIRECTION MODE to
Only one side	↔
Both sides	↻ or RELAY

- 4 Press STANDBY.
▷ lights up and the CD player changes to play pause and deck B to recording pause. If **▷** doesn't light up, press **▷** once.

To record on the reverse side
Press **◁** once.

- 5 Press START.

To stop Synchro-recording

Press STOP.

💡 If your CD player has the Peak Search function
After performing Steps 1 to 3 above, press PRESET to turn on the Auto Rec Level function (see page 12). Then continue from Step 4.

💡 You can use the remote to operate the CD player
To start CD play, press **||** twice; to pause CD play, press **||** once; to locate a CD track, press **◀◀** or **▶▶**.

Note

Some CD player might not start playback when you press START. In this case, press **||** on the CD player to start playback.

Precautions

On safety

- Do not disassemble the cabinet — this may result in an electrical shock. Refer servicing to qualified personnel only.
- Should any solid object or liquid fall into the cabinet, unplug the tape deck and have it checked by qualified personnel before operating it any further.

On power sources

- Before operating the tape deck, check that the operating voltage of the tape deck is identical with your local power supply. The operating voltage is indicated on the nameplate at the rear of the tape deck.
- The unit is not disconnected from the AC power source (mains) as long as it is connected to the wall outlet, even if the unit itself has been turned off (TC-WE835S U.S.A. and Canadian models only).
- If you are not going to use the tape deck for a long time, be sure to disconnect the tape deck from the wall outlet. To disconnect the AC power cord, grasp the plug itself; never pull the cord.
- AC power cord must be changed only at the qualified service shop.

On operation

- Because of a safety mechanism, the function buttons will not operate if the cassette holder is not completely closed, if there is no cassette in the cassette holder, or if a cassette has been incorrectly inserted into the cassette holder.
- Be sure to stop the tape before turning off the tape deck. Otherwise, the tape may be damaged.

On placement

- Place the tape deck in a location with adequate ventilation to prevent heat build-up in the tape deck.
- Do not place the tape deck:
 - on a soft surface such as a rug that might block the ventilation holes on the bottom.
 - in a location near heat sources.
 - in a place subject to direct sunlight.
 - in an inclined position.
 - in a place subject to excessive dust or mechanical shock.

On cleaning the tape deck

Clean the cabinet, panel and controls with a soft cloth slightly moistened with a mild detergent solution. Do not use any type of abrasive pad, scouring powder or solvent such as alcohol or benzene.

If you have any questions or problems concerning your tape deck, please consult your nearest Sony dealer.

Notes on Cassette Tapes

To protect a recording on side A or B
Break out the respective tab.

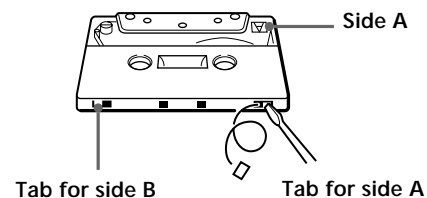

To record on a tape with a missing record-protect tab

Cover the respective tab hole with adhesive tape.

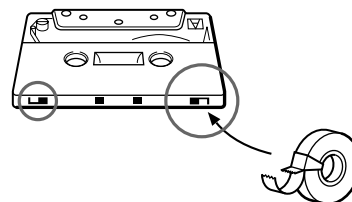

When you are using a type II or type IV tape, be careful not to cover the detector slots that the deck uses to determine the tape type.

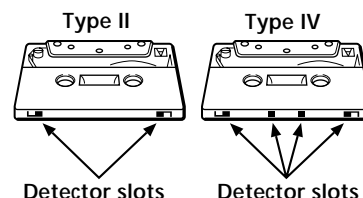

On tapes longer than 90 minutes

We do not recommend the use of tapes longer than 90 minutes except for a long continuous recording or playback. They are very thin and tend to stretch easily.

On handling cassettes

- To prevent the heads and tape path from getting dirty, avoid touching the tape surface of a cassette.
- Place cassettes away from equipment with magnets, such as speakers and amplifiers, which may cause tape distortion or erase the recordings.
- Do not expose cassettes to direct sunlight, extremely cold temperature, or moisture.

Cleaning

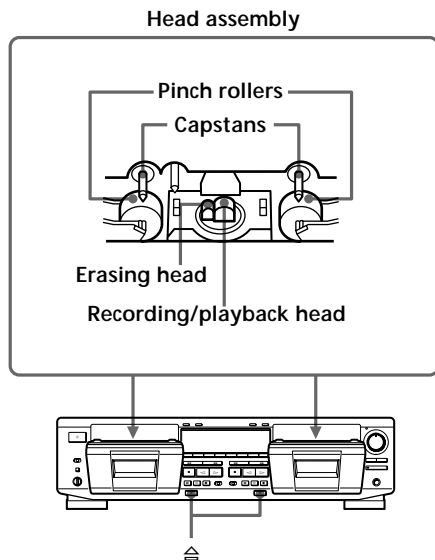

Demagnetizing the heads

After 20 to 30 hours of use, or when you notice a hissing sound or loss of high frequencies, demagnetize the heads with a commercially available demagnetizer for tape decks. Please refer to the instructions of the demagnetizer.

Cleaning the heads and tape path

Clean the heads and tape path of the tape deck after every 10 hours of operation to guard against:

- low-quality sound
- a decrease in sound level
- excessive wow or flutter
- sound dropout
- incomplete erasure
- impairment of recording function

To ensure better recording, we recommend that you clean the heads and tape path before every recording.

- 1** Press  to open the cassette holder. Grasp the front cover on both sides and gently lift to remove it.
- 2** With the tape deck turned off, wipe the heads, the pinch rollers and the capstans with a cotton swab slightly moistened with alcohol or a commercially available cleaning fluid for tape decks.
- 3** Replace the front cover.

Troubleshooting

If you've experienced any of the following difficulties while using the tape deck, use this troubleshooting guide to help you remedy the problem. Should the problem persist, consult your nearest Sony dealer.

The function buttons do not work.

- ➔ The tape deck has been just turned on and does not operate for about 3 seconds. Wait until **II** stops flashing.
- ➔ Check that the cassette is inserted correctly and the cassette holder is closed completely.

The tape deck does not play or record.

- ➔ There is no cassette in the cassette holder.
- ➔ The tape has come to the end.
- ➔ The tape is slack. Take up the tape slack.
- ➔ The record-protect tab has been removed from the cassette (see page 18).
- ➔ Make sure the amplifier setting is correct.
- ➔ Check that the tape deck connections are secure.
- ➔ The heads and tape path are dirty. Clean them (see page 19).
- ➔ The recording/playback head is magnetized. Demagnetize it (see page 19).

There is excessive wow, flutter or sound drop-out.

- ➔ The capstans and pinch rollers are dirty. Clean them (see page 19).

There is a decrease in sound level, sound drop-out, or poor reproduction of high frequencies./The tape does not erase completely./Noise increases.

- ➔ The recording/playback or erasing head and tape path are dirty. Clean them (see page 19).
- ➔ The recording/playback or erasing head is magnetized. Demagnetize it (see page 19).

There is hum or noise.

- ➔ The tape deck is placed near a TV or VCR. Move the tape deck away from the TV or VCR.
- ➔ The tape deck is placed on or under the amplifier. Move the tape deck away from the amplifier.

There is an unbalanced tone.

- ➔ Check that DOLBY NR position is the same as when the tape was recorded. An unbalanced tone may result when a tape recorded in the S Dolby NR is played back in B or C, or when a tape recorded in the B or C Dolby NR is played back in the S (TC-WE835S only).
- ➔ The tape deck is placed near a TV or VCR. Move the tape deck away from the TV or VCR.

The tape stops before the tape has been fully rewind.

- ➔ The tape is slack. Take up the tape slack.
- ➔ If "M" is shown in the display, press MEMORY repeatedly until "M" disappears.
- ➔ The cassette shell is bent. Use another cassette.

The Multi-AMS function does not work properly.

- ➔ One of the tracks contains a long pause, a passage of low frequencies or very low volume, or a gradual increase or decrease in volume.
- ➔ The space before a track is less than 4 seconds long. Insert a blank space of 4 seconds using the REC MUTING **□** button.
- ➔ The signal strength of the left and right channels are very different.
- ➔ There is noise in the space before a track.
- ➔ You pressed the **▶▶** (or **◀◀**) button immediately before the beginning of the next track or immediately after the beginning of the current track.

The Dolby NR function does not work properly during playback.

- ➔ The Pitch Control function is on and the frequency characteristics of the sound is altered. Push the PITCH CONTROL button again to turn off the function.

The High-Speed Fast-Forwarding and Rewinding functions do not work (TC-WE835S only).

- ➔ You pressed the **▶▶** (or **◀◀**) button when there is little tape remaining in that direction. This is to protect the tape.
- ➔ To protect the tape, the high-speed fast-forwarding or rewinding function may operate for only a short time or not at all when activated in the middle of the tape.

There is excessively loud tape transport noise during fast-forwarding or rewinding.

- ➔ This noise is caused by the cassette and is not a mechanical problem.

⊞ does not work.

- ➔ The tape deck is playing back or recording. Press the **■** or PAUSE **II** button to stop playback or recording before pressing the **⊞** button.
- ➔ A power failure has occurred, the tape deck has been turned off or the power cord has been disconnected during tape operation. Reconnect the power or turn off the tape deck, then on again.

Specifications

System

Recording system

4-track 2-channel stereo

Fast-winding time (approx.)

TC-WE835S: 90 sec. (with Sony C-60 cassette)

TC-WE635: 100 sec. (with Sony C-60 cassette)

High-speed fast-winding time (approx.) (TC-WE835S only)

45 sec. (with Sony C-60 cassette)

Bias

AC bias

Signal-to-noise ratio (at peak level and weighted with Dolby NR off)

Type I tape, Sony Type I (NORMAL): 55 dB

Type II tape, Sony Type II (HIGH): 57 dB

Type IV tape, Sony Type IV (METAL): 58 dB

S/N ratio improvement (approximate values)

With Dolby B NR on: 5 dB at 1 kHz, 10 dB at 5 kHz

With Dolby C NR on: 15 dB at 500 Hz, 20 dB at 1 kHz

With Dolby S NR on (TC-WE835S only): 10 dB at 100 Hz, 24 dB at 1 kHz

Harmonic distortion

0.4% (with Type I tape, Sony Type I (NORMAL):
160 nWb/m 315 Hz, 3rd H.D.)

1.8% (with Type IV tape, Sony Type IV (METAL):
250 nWb/m 315 Hz, 3rd H.D.)

Frequency response (Dolby NR off)

Tape type

Type I tape, Sony Type I (NORMAL)	30 – 16,000 Hz (±3 dB, IEC), 20 – 17,000 Hz (±6 dB)
-----------------------------------	--

Type II tape, Sony Type II (HIGH)	30 – 17,000 Hz (±3 dB, IEC), 20 – 18,000 Hz (±6 dB)
-----------------------------------	--

Type IV tape, Sony Type IV (METAL)	30 – 19,000 Hz (±3 dB, IEC), 20 – 20,000 Hz (±6 dB), 30 – 13,000 Hz (±3 dB, –4 dB recording)
------------------------------------	--

Wow and flutter

TC-WE835S:

±0.13% W. Peak (IEC)

0.07% W. RMS (NAB)

±0.18% W. Peak (DIN)

TC-WE635:

±0.13% W. Peak (IEC)

0.1% W. RMS (NAB)

±0.2% W. Peak (DIN)

Variable pitch range (approx.)

–30 to +30%

Inputs

Line inputs (phono jacks)

Sensitivity: 0.16 V

Input impedance: 47 kilohms

Outputs

Line outputs (phono jacks)

Rated output level: 0.5 V at a load impedance of 47 kilohms

Load impedance: Over 10 kilohms

Headphones (stereo phone jack)

Output level: 0.25 mW at a load impedance of 32 ohms

General

Power requirements

Where purchased	Power requirements
U.S.A. and Canada	120 V AC, 60 Hz
U.K., Continental Europe, China and certain countries in Asia	220 – 230 V AC, 50/60 Hz
Australia	240 V AC, 50/60 Hz
Other countries	120/220/230 – 240 V AC, 50/60 Hz

Power consumption

TC-WE835S: 30 W

TC-WE635: 22 W

Dimensions (approx.) (w/h/d)

Model for U.K. and Australia:

430 × 120 × 310 mm

Model for other countries:

430 × 120 × 290 mm

(17 × 4³/₄ × 11¹/₂ in.)

including projecting parts and controls

Mass (approx.)

4.3 kg (9 lbs 8 oz)

Supplied accessories

See page 4.

Optional accessory

Remote commander RM-J910 (except TC-WE835S U.S.A. model)

For more information on the availability of the remote commander, contact your nearest Sony dealer.

Design and specifications are subject to change without notice.

Glossary

ATS

Automatic Tape Selection. The tape deck automatically sets the appropriate equalization characteristics and bias current according to the type of tape inserted in the deck.

Automatic calibration

The automatic adjustment of the bias current and recording level for the inserted tape.

This adjustment works together with the deck's ATS (Automatic Tape Selection, see above) to get the best possible recording results on any tape.

Auto Rec Level function

A function that automatically sets the recording level according to the peak signal level of the program source prior to recording.

When active, this function gradually decreases the recording level when the signal level rises excessively during recording.

Dolby HX Pro

A system that reduces distortion, and increases high-frequency headroom during recording. A tape recorded with this system produces the same high-quality sound even when played on other tape decks.

Dolby NR (noise reduction)

A system that eliminates tape hiss noise by boosting low-level signals in the high-frequency range during recording, then lowering them during playback.

There are four types: A, B, C and S (TC-WE835S only). Type A is for professional use (and is not available on your tape deck), and types B, C and S are for consumer use. Type S has the maximum noise reduction capability, followed by types C and B.

Multi-AMS

Multi-Automatic Music Sensor is a function that locates the beginning of up to 30 tracks before or after the current track by detecting the blank space (of over 4 seconds) between tracks.

Multiplex filter

A filter for eliminating the 19-kHz stereo carrier and the 38-kHz sub-carrier signals that may impair the Dolby NR system. Though tuners are usually equipped with this filter, if you got poor results when recording FM broadcasts with the Dolby NR, your tuner may not have a filter or the filter may not be working. In this case, set the DOLBY NR selector on the tape deck to ON FILTER.

Test tones

Signals (10-kHz and 400-Hz) generated by the tape deck for bias current and recording level calibration.

Index

A, B

- Accessories
 - optional 21
 - supplied 4
- Adjusting
 - recording level automatically. *See* Auto rec level
 - recording level manually 7
 - volume 5
- ATS 11, 22
- Audio connecting cord 4
- Auto play 8
- Automatic Music Sensor. *See* Multi-AMS
- Automatic calibration 11, 22
- Automatic Tape Selection. *See* ATS
- Auto rec level 12, 22

C

- Cassette. *See* Tape
- CD synchro-recording
 - through a control A1 cord 16
 - using a remote 17
- Cleaning
 - cabinet 18
 - heads and tape path 19
- Connecting. *See* Hooking up
- Control A1 cord 4, 16

D, E, F, G

- Difference between the models 2
- Dolby HX Pro 7, 22
- Dolby NR 5, 7, 22
- Dubbing
 - high-speed dubbing 13
 - normal-speed dubbing 13
 - only specific portions 14
 - RMS dubbing 15
- Fader 13
- Fading
 - in. *See* Fader
 - out. *See* Fader
- FILTER. *See* Multiplex filter

H, I, J, K

- Heads
 - cleaning 19
 - demagnetizing 19
- High-speed
 - fast-forwarding function 5
 - rewinding function 5
- Hooking up
 - hookups 4
 - overview 4
- Insert
 - blank space 16
 - cassette 5, 6

L

- Locating
 - beginning of the tape 8
 - particular point 8
 - tracks 8

M, N, O

- Memory play 8
- Multi-AMS 8, 22
- Multiplex filter 7, 22

P, Q

- Pitch control function 5
- Playing
 - auto play 8
 - basic play 5
 - memory play 8
 - RMS play 9

R

- Random Music Sensor. *See* RMS play or dubbing
- Recording
 - basic recording 6
 - CD synchro-recording 16
 - FM broadcasts 7
 - on both decks in succession. *See* Relay recording
 - the same source on both decks. *See* Simultaneous recording
- Record muting 16
- Relay recording 14
- Remote commander 4, 17, 21
- RMS dubbing 15
- RMS play
 - adding tracks 10
 - checking the order of tracks 9

S

- Searching. *See* Locating
- Simultaneous recording 15
- Specifications 21

T

- Tape
 - ejecting 5, 7
 - notes 18
 - path cleaning 19
 - protect the recording 18
 - type 18
- Test tones 11, 22
- Troubleshooting 20

U, V, W, X, Y, Z

- Unpacking 4

Names of Controls**Buttons**

- A+B REC (simultaneous recording) 15
- ARL (automatic recording level adjustment) 12
- CHECK 9
- DECK A/DECK B 11
- DISPLAY 9
- FADER 13
- HIGH/NORMAL 13, 15
- MEMORY 8
- PAUSE ■ 6, 11 – 13, 15, 16
- PITCH CONTROL 5
- REC (recording) ● 6, 12, 14
- REC MUTING (record muting) ○ 16
- RESET 8
- RMS/START 9, 15
- SET 9
- SYNCHRO 16
- ⊞ (eject) 5, 6, 19
- (stop/RMS CLEAR) 9, 12, 13
- ▷ (forward play/RMS FRONT) 5, 6, 8, 9, 11 – 16
- ◁ (reverse play/RMS BACK) 8, 9, 11, 13 – 16
- ▶▶, ◀◀ (fast-forwarding and rewinding/AMS/RMS +/-) 8, 9

Selectors

- DIRECTION MODE 5, 6, 13 – 16
- DOLBY NR 7

Switches

- Ⓞ (or I/Ⓞ) (power) 5, 6

Controls

- PITCH CONTROL 5
- REC (recording) LEVEL 7, 12

Jacks

- CONTROL A1 4
- LINE IN 4
- LINE OUT 4
- PHONES 5

Others

- AUTO indicator 6, 12, 13
- Cassette holder 5, 6, 19
- Peak level meters 7
- SYNCHRO button indicator 17

