

# ***CD Radio Cassette-Corder***

---

Operating Instructions

***CFD-S47***

## Warning

To prevent fire or shock hazard, do not expose the player to rain or moisture.

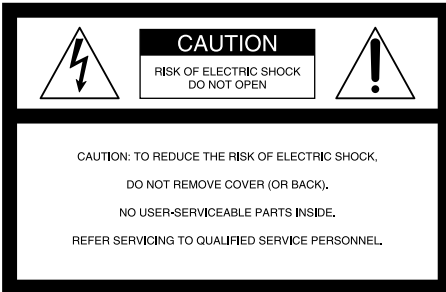

This symbol is intended to alert the user to the presence of uninsulated “dangerous voltage” within the product’s enclosure that may be of sufficient magnitude to constitute a risk of electric shock to persons.



This symbol is intended to alert the user to the presence of important operating and maintenance (servicing) instructions in the literature accompanying the appliance.

## CAUTION

The use of optical instruments with this product will increase eye hazard.

## WARNING

Do not install the appliance in a confined space, such as a bookcase or built-in cabinet.

### For customers in Canada

To prevent electric shock, match wide blade of plug to wide slot, fully insert.

## Information

### For customers in the United States

This equipment has been tested and found to comply with the limits for a Class B digital device, pursuant to Part 15 of the FCC Rules. These limits are designed to provide reasonable protection against harmful interference in a residential installation. This equipment generates, uses and can radiate radio frequency energy and, if not installed and used in accordance with the instructions, may cause harmful interference to radio communications. However, there is no guarantee that interference will not occur in a particular installation. If this equipment does cause harmful interference to radio or television reception, which can be determined by turning the equipment off and on, the user is encouraged to try to correct the interference by one or more of the following measures:

- Reorient or relocate the receiving antenna.
- Increase the separation between the equipment and receiver.
- Connect the equipment into an outlet on a circuit different from that to which the receiver is connected.
- Consult the dealer or an experienced radio/TV technician for help.

You are cautioned that any changes or modifications not expressly approved in this manual could void your authority to operate this equipment.

## Owner's Record

The model number is located at the bottom and the serial number is located in the battery compartment.

Record the serial number in the space provided below. Refer to these numbers whenever you call upon your Sony dealer regarding this product.

Model No. CFD-S47

Serial No. \_\_\_\_\_

---

# Table of contents

---

## Basic Operations

- 4 Playing a CD
  - 6 Listening to the radio
  - 8 Playing a tape
  - 10 Recording on a tape
- 

### The CD Player

- 12 Using the display
- 13 Locating a specific point in a track
- 14 Playing tracks repeatedly (Repeat Play)
- 15 Playing tracks in random order (Shuffle Play)
- 16 Creating your own program (Program Play)
- 18 Enjoying sound effects (LOOP/FLASH)

### The Radio

- 19 Presetting radio stations
- 20 Playing preset radio stations

### The Timer

- 21 Setting the clock
- 22 Waking up to music
- 24 Falling asleep to music

### Setting Up

- 25 Choosing the power sources
- 27 Selecting the audio emphasis (Sound Mode/MEGA BASS)

### Additional Information

- 28 Precautions
- 30 Troubleshooting
- 32 Maintenance
- 33 Specifications
- 34 Index

# Playing a CD

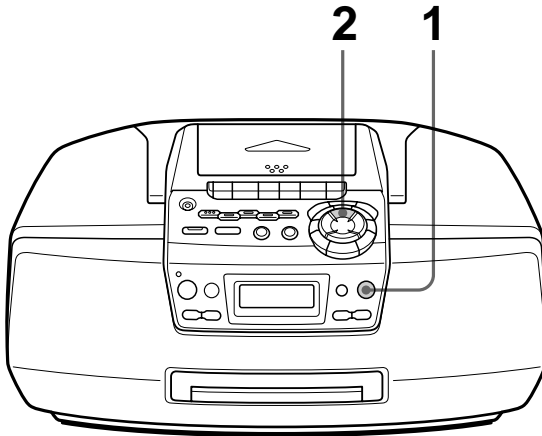

Connect the supplied AC power cord (see page 25).

1



Press  CD OPEN/CLOSE (direct power-on) and place the CD on the CD tray.

With the label side up

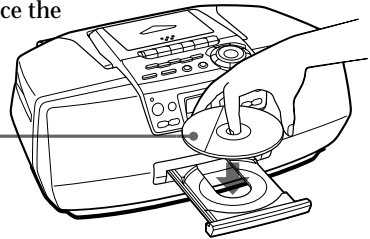

2

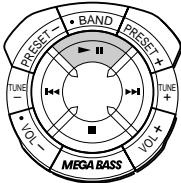

Press .

The CD tray closes and the player plays all the tracks once.

Display

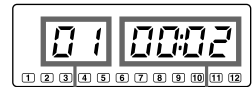

Track number

Playing time

Use these buttons for additional operations

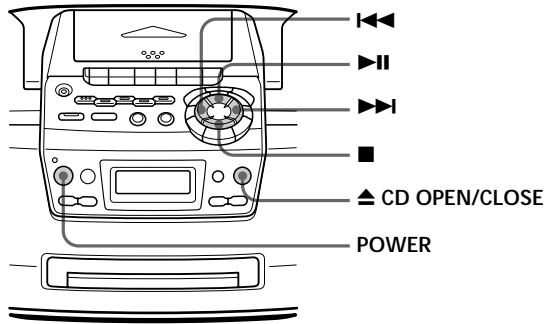

Tip

Next time you want to listen to a CD, just press ►||. The player turns on automatically and starts playing the CD.

To	Press
adjust the volume	VOL +, -
stop playback	■
pause playback	►   (   on the remote) Press the button again to resume play after pause.
go to the next track	►►
go back to the previous track	◄◄
remove the CD	▲ CD OPEN/CLOSE
turn on/off the player	POWER

# Listening to the radio

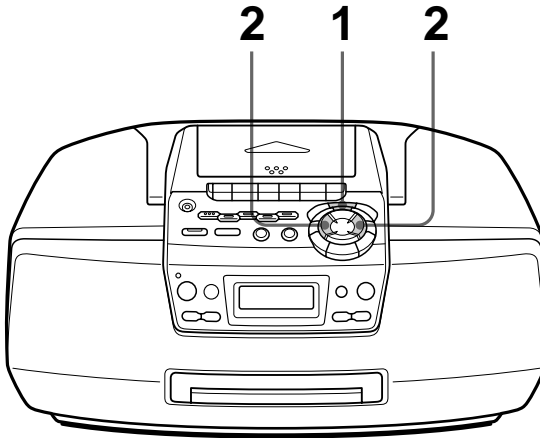

Connect the supplied AC power cord (see page 25).

1

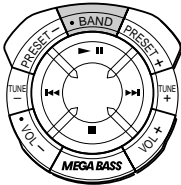

Press **BAND** until the band you want appears in the display (direct power-on).

Display

2

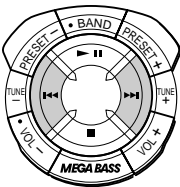

Hold down **TUNE +** / **▶▶▶** or **TUNE -** / **◀◀◀** (TUNE + or - on the remote) until the frequency digits begin to change in the display.

Indicates an FM stereo broadcast

The player automatically scans the radio frequencies and stops when it finds a clear station.

If you can't tune in a station, press the button repeatedly to change the frequency step by step.

### Use these buttons for additional operations

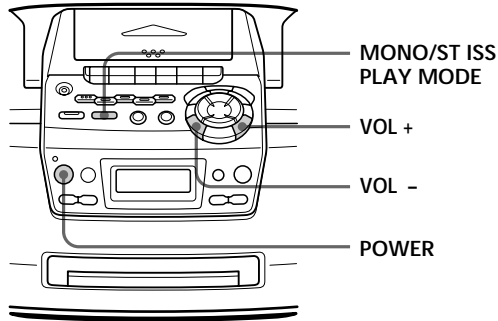

#### Tips

- If the FM broadcast is noisy, press MONO/ST ISS •PLAY MODE until "Mono" appears in the display and the radio will play in monaural.
- Next time you want to listen to the radio, just press BAND. The player turns on automatically and starts playing the previous station.

To	Press
adjust the volume	VOL +, -
turn on/off the radio	POWER

#### To improve broadcast reception

Reorient the antenna for FM. Reorient the player itself for AM.

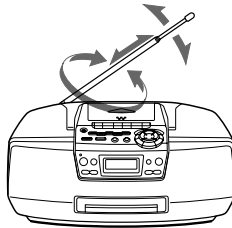

for FM

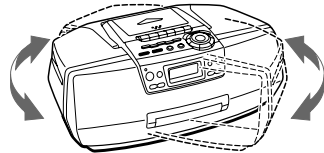

for AM

# Playing a tape

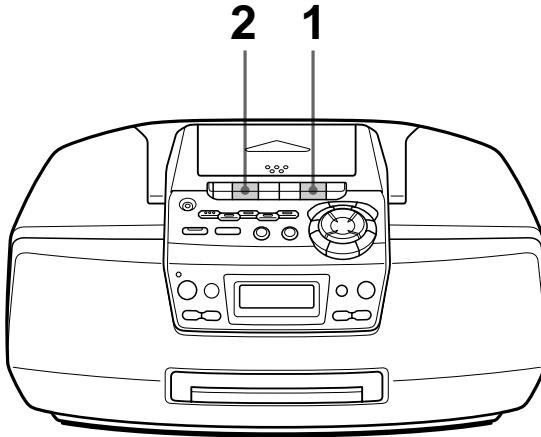

Connect the supplied AC power cord (see page 25).

1

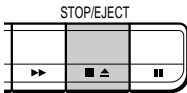

Press  to open the tape compartment and insert a recorded tape. Use TYPE I (normal) tape only. Close the compartment.

With the side you want to play facing upward

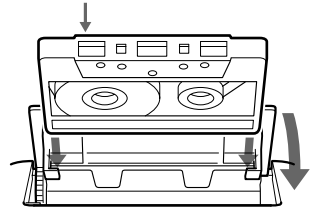

2

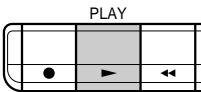

Press .

The player turns on (direct power-on) and starts playing.

Display

TAPE

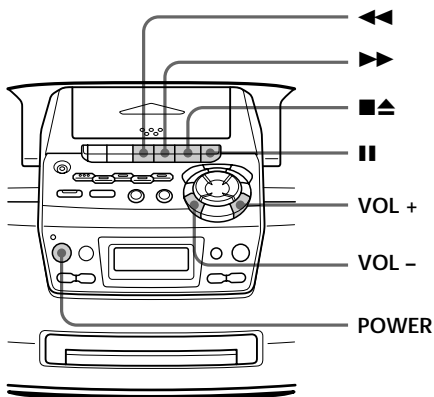

## Use these buttons for additional operations

**Tip**

Next time you want to listen to a tape, just press ►. The player turns on automatically and starts playing the tape.

To	Press
adjust the volume	VOL +, -
stop playback	■▲
fast-forward or rewind the tape	▶▶ or ◀◀
pause playback	 Press the button again to resume play after pause.
eject the cassette	■▲
turn on/off the player	POWER

# Recording on a tape

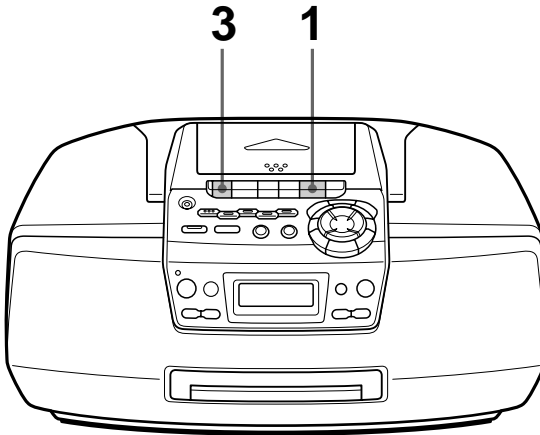

Connect the supplied AC power cord (see page 25).

1

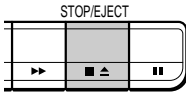

Press to open the tape compartment and insert a blank tape. Use TYPE I (normal) tape only.

With the side you want to record on facing upward

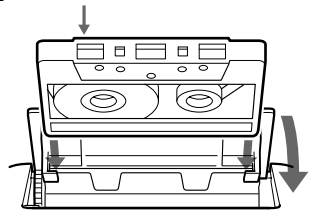

2

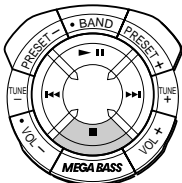

Select the program source you want to record.

To record from the CD player, insert a CD (see page 4) and press on the CD section.

Display

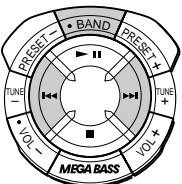
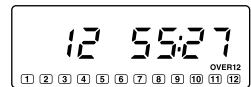

To record from the radio, tune in the station you want (see page 6).

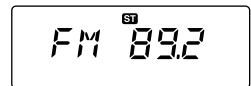

3

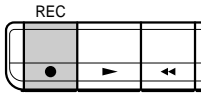

Press ● to start recording  
(▶ is depressed automatically).

Use these buttons for additional operations

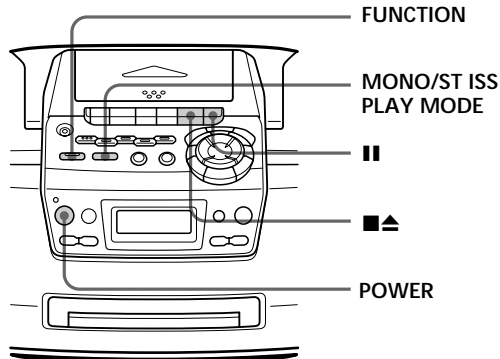

#### Tips

- Adjusting the volume or the audio emphasis (see page 27) will not affect the recording level.
- If the AM program makes a whistling sound after you've pressed ● in step 3, press MONO/ST ISS•PLAY MODE (Interference Suppress switch) repeatedly until the noise is at a minimum.
- For the best results, use the AC power as a power source.
- To erase a recording, proceed as follows:
  - 1 Insert the tape whose recording you want to erase.
  - 2 Press FUNCTION to select "TAPE".
  - 3 Press ●.

To	Press
stop recording	■▲
pause recording	 Press the button again to resume recording.
turn on/off the player	POWER

# Using the display

You can check information about the CD using the display.

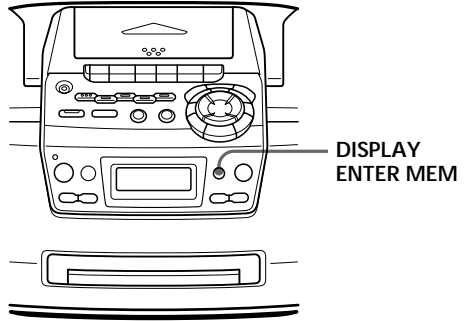

## Checking the total track number and playing time

Check the display in stop mode.

If the CD has more than 12 tracks, "OVER 12" appears in the display.

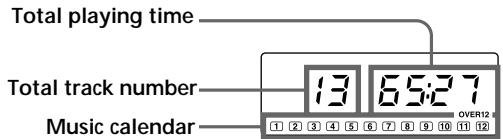

## Checking the remaining time

Press DISPLAY•ENTER MEM while playing a CD.

The track numbers in the music calendar disappear after they are played.

To display	Press DISPLAY•ENTER MEM
the current track number and the remaining time on the current track*	once
the number of tracks left and remaining time on the CD	twice
the current track number and playing time	three times

\* For a track whose number is more than 20, the remaining time appears as "--:--".

# Locating a specific point in a track

You can quickly find a specific point in a track while playing a CD.  
You can also locate any track using the number buttons on the remote.

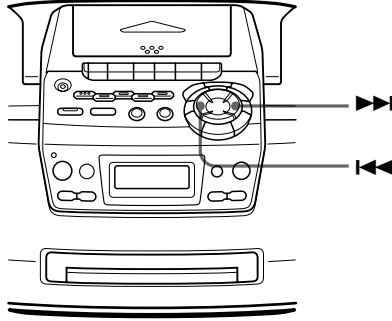

To locate	Press
a point while listening to the sound	▶▶ (forward) or ◀◀ (backward) while playing and hold down until you find the point
a point while observing the display	▶▶ (forward) or ◀◀ (backward) in pause and hold down until you find the point
a specific track directly	the number button of the track on the remote

## Note

You cannot locate a specific track if “SHUF” or “PGM” is lit in the display. Turn off the indication by pressing ■.

## Tip

When you locate a track numbered over 10, press >10 first, then the corresponding number buttons.

Example:

To play track number 23, press >10 first, then 2 and 3.

# Playing tracks repeatedly

## (Repeat Play)

You can play tracks repeatedly in normal, shuffle or program play modes (see page 16).

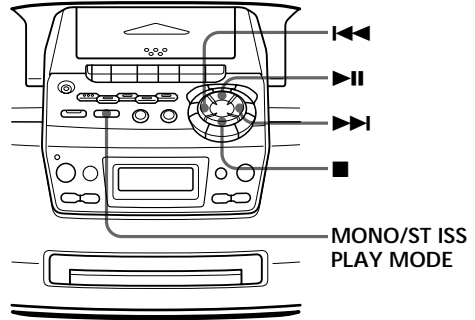

### On the remote

- 1 Press ■.
- 2 Press MODE until the repeat mode you want appears in the display.
- 3 Do either of the following to start repeat play:
  - When you've selected "REP 1", select the track by pressing the number button.
  - When you've selected "REP ALL" or "SHUF REP", press ►.
  - When you've selected "PGM REP", program tracks (see step 3 on page 16), then press ►.

- 1 Press ■.  
"Cd" appears in the display.

- 2 Proceed as follows.

To repeat	Do this
a single track	<ol style="list-style-type: none"> <li>1 Press MONO/ST ISS • PLAY MODE until "REP 1" appears.</li> <li>2 Press ◀◀ or ▶▶ to select the track that you want to repeat.</li> <li>3 Press ►►.</li> </ol>
all the tracks	<ol style="list-style-type: none"> <li>1 Press MONO/ST ISS • PLAY MODE until "REP ALL" appears.</li> <li>2 Press ►►.</li> </ol>
tracks in random order	<ol style="list-style-type: none"> <li>1 Press MONO/ST ISS • PLAY MODE until "SHUF REP" appears.</li> <li>2 Press ►►.</li> </ol>
programmed tracks	<ol style="list-style-type: none"> <li>1 Press MONO/ST ISS • PLAY MODE until "PGM REP" appears.</li> <li>2 Program tracks (see step 3 on page 16).</li> <li>3 Press ►►.</li> </ol>

### To cancel Repeat Play

Press MONO/ST ISS • PLAY MODE until "REP" disappears from the display.

# Playing tracks in random order

## (Shuffle Play)

You can play tracks in random order.

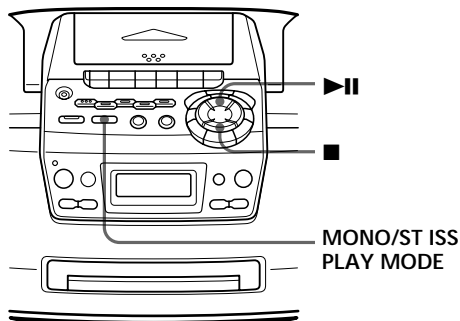

### On the remote

- 1 Press ■.
- 2 Press MODE repeatedly until "SHUF" appears in the display.
- 3 Press ►.

- 1 Press ■.  
"Cd" appears in the display.
- 2 Press MONO/ST ISS•PLAY MODE until "SHUF" appears in the display.
- 3 Press ► to start shuffle play.

### To cancel Shuffle Play

Press MONO/ST ISS•PLAY MODE until "SHUF" disappears from the display.

# Creating your own program

## (Program Play)

You can arrange the playing order of up to 20 tracks on a CD.

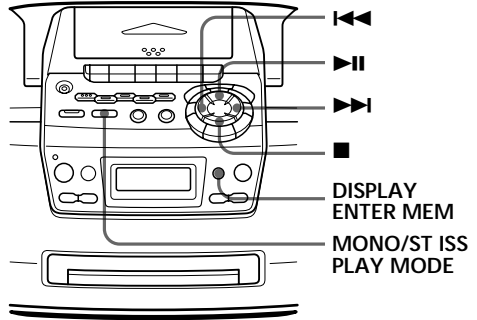

### On the remote

- 1 Press ■.
- 2 Press MODE until “PGM” appears in the display.
- 3 Press the number buttons for the tracks you want to program in the order you want.
- 4 Press ►.

- 1 Press ■.  
“Cd” appears in the display.
- 2 Press MONO/ST ISS•PLAY MODE until “PGM” appears in the display.
- 3 Press the ◀◀ or ▶▶ then press DISPLAY•ENTER MEM for the tracks you want to program in the order you want.

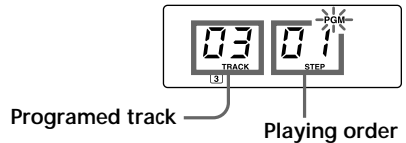

The programed tracks appear in the music calender.

- 4 Press ▶▶ to start program play.



### Tips

- You can play the same program again, since the program is saved until you open the CD tray.
- You can record your own program. After you've created the program, insert a blank tape and press ● to start recording.

### To cancel Program Play

Press MONO/ST ISS•PLAY MODE until "PGM" disappears from the display.

### To check the order of tracks before play

Press DISPLAY•ENTER MEM.

Every time you press the button, the track number appears in the programmed order.

### To change the current program

Press ■ once if the CD is stopped and twice if the CD is playing. The current program will be erased. Then create a new program following the programming procedure.

# Enjoying sound effects (LOOP/FLASH)

You can repeat part of a CD (LOOP) and can “flash” the CD sound (FLASH) during playback.

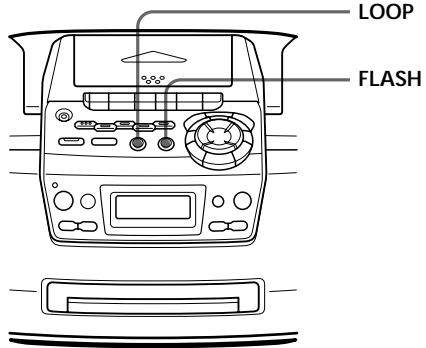

- 1 Play a CD.
- 2 Press and hold LOOP or FLASH at the point you want to start the function.

To	Press and hold
repeat a selected part of a CD	LOOP
“flash” the CD sound	FLASH

## To cancel the LOOP or FLASH function

Release the button.

The player returns to normal play.

# Presetting radio stations

You can store radio stations into the player's memory. You can preset up to 20 radio stations, 10 for each band in any order.

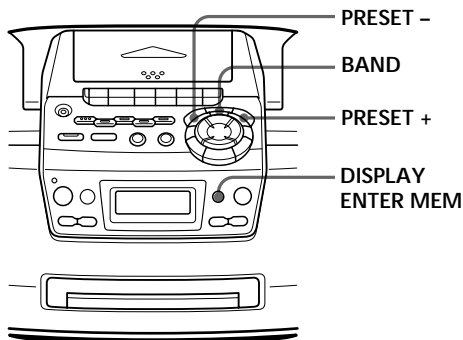

## On the remote

- 1 Press **BAND** to select the band.
- 2 Set the frequency to the station you want.
- 3 Hold down the number buttons that you want to preset the new station on for 2 seconds.

The frequency digits flash in the display and the station is stored into the player's memory.

- 1 Press **BAND** until the band you want appears in the display.
- 2 Set the frequency to the station you want.
- 3 Hold down **DISPLAY • ENTER MEM** for 2 seconds.
- 4 Press **PRESET +** or **-** until the preset number (1 to 10) you want for the station flashes in the music calender.
- 5 Press **DISPLAY • ENTER MEM** again.  
The new station replaces the old one.

# Playing preset radio stations

Once you've preset the stations, use the number buttons on the remote or PRESET +/- on the player to tune in to your favorite stations.

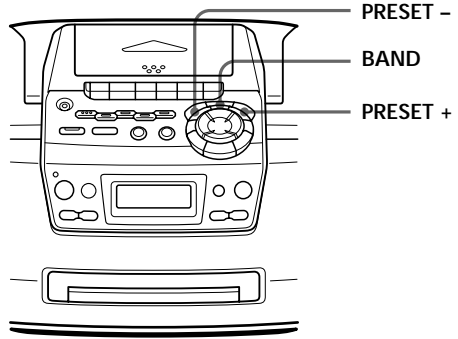

## On the remote

- 1 Press BAND to select the band.
- 2 Press the number buttons to tune in the stored station.

- 1 Press BAND to select the band.
- 2 Press PRESET + or - to tune in the stored station.

# Setting the clock

“--:--” indication appears in the display until you set the clock.

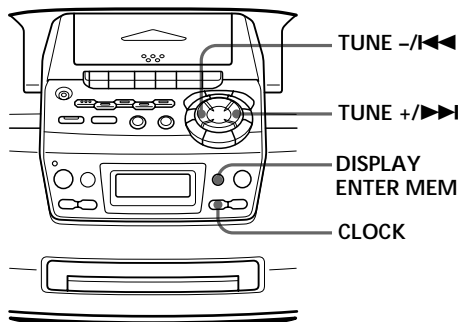

## Tip

The time display system:  
12-hour system

- 1 Press **CLOCK** for 2 seconds until the hour digit flashes.

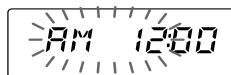

- 2 Press **TUNE +/>>>** or **TUNE -/I<<<** until you set the current hour. Then press **DISPLAY • ENTER MEM**.

The minute digits flash. Set the minutes by pressing **TUNE +/>>>** or **TUNE -/I<<<** until the correct minute is displayed.



- 3 Press **DISPLAY • ENTER MEM**.  
The clock starts from 00 seconds.

# Waking up to music

You can wake up to music or a radio program at a preset time. Make sure you have set the clock (“Setting the clock” on page 21).

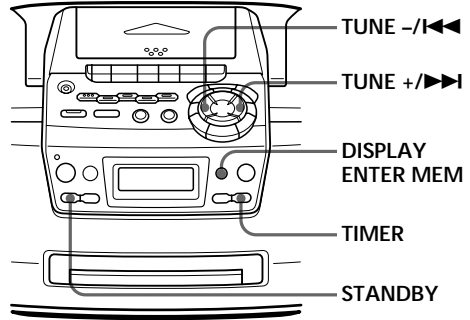

Before you begin, make sure the ☹ (clock) indication is not lit in the display. If it is lit, press STANDBY.

## 1 Prepare the music source you want to play.

To play	Do this
the radio	Tune in a station
a CD	Insert a CD

## 2 Press TIMER.

The ☹ (clock) and the music source (“Cd” or “RADIO”) flash.

## 3 Select the music source (“Cd” or “RADIO”) by pressing TUNE +/▶▶ or TUNE -/I◀◀, then DISPLAY • ENTER MEM.

## 4 Set the timer to the hour you want the music to start by pressing TUNE +/▶▶ or TUNE -/I◀◀, then DISPLAY • ENTER MEM.

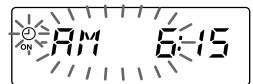

Set the minutes, then press DISPLAY • ENTER MEM.

## 5 Set the timer to the hour and the minutes you want the music to go off. (Do as step 4.)

**Tips**

- The display window does not light while the waking up timer is on.
- You can have the player go on the next day at the same time. Just press STANDBY until the ☉ indication appears in the display. The preset settings remain until you reset them.

- 6** Press TUNE +/▶▶▶ or TUNE -/◀◀◀ to set the volume, then DISPLAY•ENTER MEM.

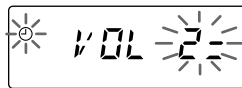

- 7** Press STANDBY.

The ☉ indication lights up and the power goes off.

At the preset time, the power will go on, and the music will play. Then the power will go off at the preset time, and the player will enter into the standby mode.

**To check/change when the playback will start**

Press TIMER, then DISPLAY•ENTER MEM. Each time you press DISPLAY•ENTER MEM, a stored setting is displayed in the set order. To change the setting, display the setting you want to change and re-enter it.

**To use the player before a timer playback starts**

Just turn on the player, and then you can use it.

If you turn off the player before the preset time, timer playback will start at the preset time.

In case of the radio, however, if you listen to the station which is different from the one you tuned in in step 1 on page 22, you will hear that station at the preset time. Make sure to tune in the station you want to listen to before you turn off the player.

**To stop play**

Press POWER to turn off the power.

# Falling asleep to music

You can set the player to turn off automatically after 10, 20, 30, 60, 90, and 120 minutes, allowing you to fall asleep while listening to music.

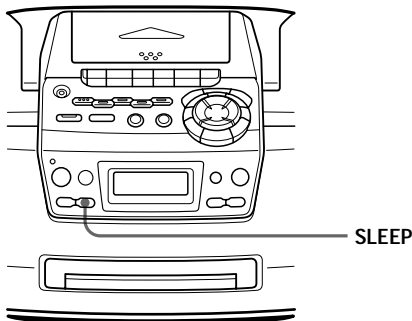

## Tips

- The display window does not light while the sleeping timer is on.
- You can fall asleep and wake up to different music. Set the waking up timer first (see page 22), turn on the power, and then set the sleeping timer. However, you cannot store different radio stations.

## Note

When you are playing a tape using this function:

If the tape length of one side is longer than the set time, the player will not go off until the tape reaches the end.

- 1 Play the music source you want.
- 2 Press SLEEP to display "SLEEP."
- 3 Press SLEEP to select the minutes until the player goes off automatically.

Each time you press the button, the indication changes as follows: "60" → "90" → "120" → no indication → "10" → "20" → "30."



## To cancel the sleep function

Press POWER to turn off the power.



# Choosing the power sources

You can use the AC power or batteries as a power source.

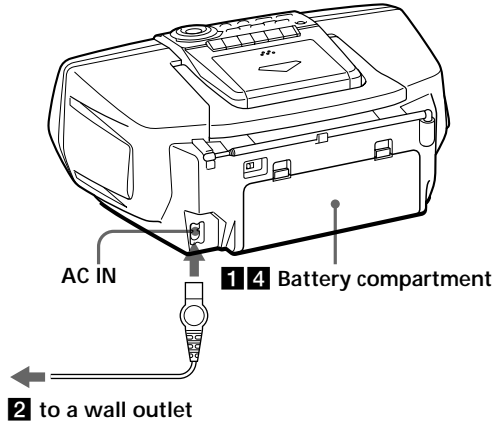

## 1 Inserting the back-up batteries

Insert four size AA (R6) batteries (not supplied) into the battery compartment. These batteries work to save the memory data.

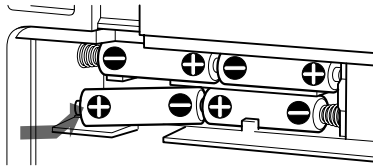

## Replacing batteries

Take out the batteries as illustrated.

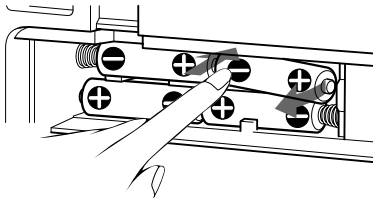

## 2 Connecting the AC power cord

Insert one end of the supplied AC power cord to the AC IN socket located at the rear of the player, and the other end to the wall outlet.

continued

## Choosing the power sources (continued)

### 3 Inserting batteries into the remote

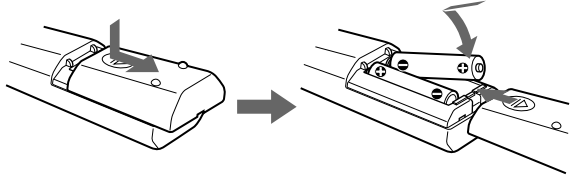

Insert two size AA (R6) batteries (not supplied)

### Replacing batteries

With normal use, the batteries should last for about six months. When the remote no longer operates the player, replace all the batteries with new ones.

### 4 Using the player on batteries

Insert six size D (R20) batteries (not supplied) into the battery compartment.

To use the player on batteries, disconnect the AC power cord from the player.

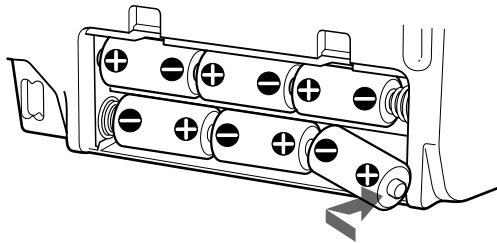

### Note

- When you operate the player on batteries,
- the backlight in the display does not light.
  - you cannot turn on the player using the remote.

### Tip

Replace the batteries when the OPR/BATT indicator dims or when the player stops operating. Replace all the batteries with new ones. Before you replace the batteries, be sure to take out the CD from the player.

# Selecting the audio emphasis (Sound Mode/MEGA BASS)

You can adjust the audio emphasis of the sound you are listening to.

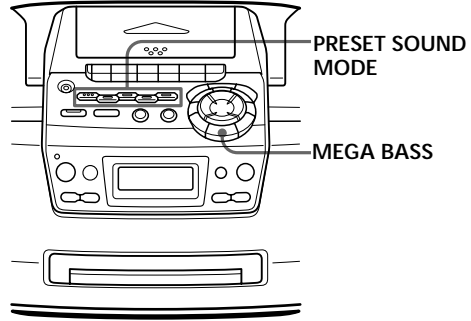

**On the remote**  
Press SOUND repeatedly to select the audio emphasis you want.

## Selecting the sound characteristic

Press one of the PRESET SOUND MODE buttons to select the audio emphasis you want.

Choose	To get
OFF	the whole dynamic range for music such as classical music
ROCK	powerful, clean sounds, emphasizing low and high range audio
POP	light, bright sounds emphasizing high and middle range audio
LIVE	percussive sounds, emphasizing bass audio
VOCAL	the presence of vocals, stressing middle range audio

## Reinforcing the bass sound

Press MEGA BASS.

"MEGA BASS" appears in the display.

To return to normal sound, press the button again.

# Precautions

## On safety

- As the laser beam used in the CD player section is harmful to the eyes, do not attempt to disassemble the casing. Refer servicing to qualified personnel only.
- Should any solid object or liquid fall into the player, unplug the player, and have it checked by qualified personnel before operating it any further.

## On power sources

- For AC operation, use the supplied AC power cord; do not use any other type.
- The player is not disconnected from the AC power source (mains) as long as it is connected to the wall outlet, even if the player itself has been turned off.
- Unplug the player from the wall outlet when it is not to be used for an extended period of time.
- For battery operation, use six size D (R20) batteries.
- When the batteries are not to be used, remove them to avoid damage that can be caused by battery leakage or corrosion.
- The nameplate indicating operating voltage, power consumption, etc. is located at the bottom.

## On placement

- Do not leave the player in a location near heat sources, or in a place subject to direct sunlight, excessive dust or mechanical shock.
- Do not place the player on an inclined or unstable place.
- Do not place anything within 10 mm of the side of the cabinet. The ventilation holes must be unobstructed for the player to operate properly and prolong the life of its components.
- If the player is left in a car parked in the sun, be sure to choose a location in the car where the player will not be subjected to the direct rays of the sun.
- Since a strong magnet is used for the speakers, keep personal credit cards using magnetic coding or spring-wound watches away from the player to prevent possible damage from the magnet.

## On operation

- If the player is brought directly from a cold to a warm location, or is placed in a very damp room, moisture may condense on the lens inside the CD player section. Should this occur, the player will not operate properly. In this case, remove the CD and wait about an hour for the moisture to evaporate.
- If the player has not been used for a long time, set it in the playback mode to warm it up for a few minutes before inserting a cassette.

If you have any questions or problems concerning your player, please consult your nearest Sony dealer.

### Notes on CDs

- Before playing, clean the CD with a cleaning cloth. Wipe the CD from the center out.



- Do not use solvents such as benzene, thinner, commercially available cleaners or anti-static spray intended for vinyl LPs.
- Do not expose the CD to direct sunlight or heat sources such as hot air ducts, nor leave it in a car parked in direct sunlight as there can be a considerable rise in temperature inside the car.
- Do not stick paper or sticker on the CD, nor scratch the surface of the CD.
- After playing, store the CD in its case.

If there is a scratch, dirt or fingerprints on the CD, it may cause tracking error.

### Notes on cassettes

- Break off the cassette tab from side A or B to prevent accidental recording. If you want to reuse the tape for recording, cover the broken tab with adhesive tape.

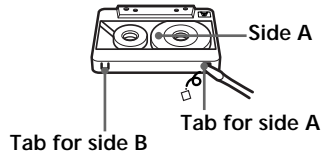

- The use of a cassette with more than 90 minutes of play time is not recommended except for long, continuous recording or playback.

# Troubleshooting

	Symptom	Remedy
General	The power is not on.	<ul style="list-style-type: none"> <li>• Connect the AC power cord to a wall outlet securely.</li> <li>• Make sure the batteries are inserted correctly.</li> <li>• You cannot turn on the player with the remote when you operate the player on batteries.</li> </ul>
	There is no audio.	<ul style="list-style-type: none"> <li>• Make sure the function you want to use appears in the display window.</li> <li>• Adjust the volume.</li> <li>• Unplug the headphones when listening through speakers.</li> </ul>
	“no disc” lights in the display even when a CD is in place.	<ul style="list-style-type: none"> <li>• Insert the CD with the label surface up.</li> </ul>
CD Player	The CD does not play.	<ul style="list-style-type: none"> <li>• Make sure that the CD tray is closed.</li> <li>• Place the CD with the label surface up.</li> <li>• Clean the CD.</li> <li>• Take out the CD and leave the CD tray open for about an hour to dry moisture condensation.</li> <li>• Make sure “Cd” appears in the display.</li> </ul>
	The sound drops out.	<ul style="list-style-type: none"> <li>• Reduce the volume.</li> <li>• Clean the CD, or replace it if the CD is badly damaged</li> <li>• Place the player in a location free from vibration.</li> </ul>
	The audio is weak or has poor quality.	<ul style="list-style-type: none"> <li>• Replace all the batteries with new ones if they are weak.</li> <li>• Move the player away from the TV.</li> <li>• If you are using the remote while listening to AM radio, noise may be heard. This is unavoidable.</li> </ul>
Radio	The picture of your TV becomes unstable.	<ul style="list-style-type: none"> <li>• If you are listening to an FM program near the TV with an indoor antenna, move the player away from the TV.</li> </ul>

	Symptom	Remedy
Tape Player	The tape does not move when you press an operation button.	<ul style="list-style-type: none"> <li>• Close the tape compartment securely.</li> </ul>
	The REC ● button does not function/The tape does not play.	<ul style="list-style-type: none"> <li>• Make sure the safety tab on the cassette is in place.</li> <li>• Make sure "TAPE" appears in the display.</li> </ul>
	The tape does not erase completely.	<ul style="list-style-type: none"> <li>• Clean the erasing head (see page 32)</li> <li>• Replace all the batteries with new ones if they are weak.</li> <li>• The source which was recorded on TYPE II (high position) or TYPE IV (metal) tape using this unit is being played. Record on TYPE I (normal) tape and play.</li> </ul>
	The tape does not record.	<ul style="list-style-type: none"> <li>• Make sure the tape is inserted properly.</li> <li>• Make sure the safety tab of the cassette is in place.</li> </ul>
	The audio is weak/The audio quality is poor.	<ul style="list-style-type: none"> <li>• Clean the heads, pinch roller and capstan (see page 32).</li> <li>• Demagnetize the heads using a demagnetizer (see page 32).</li> </ul>
	The sound is distorted.	<ul style="list-style-type: none"> <li>• The TYPE II (high position) or TYPE IV (metal) tape is being used. Use TYPE I (normal) tape only.</li> </ul>
Timer	The timer does not operate.	<ul style="list-style-type: none"> <li>• Make sure the time on the clock is correct.</li> <li>• Check to see if the AC power had been cut off.</li> <li>• Make sure the ☹ (clock) indication is displayed.</li> </ul>
	The remote does not function.	<ul style="list-style-type: none"> <li>• Replace all the batteries in the remote with new ones if they are weak.</li> <li>• Make sure that you are pointing the remote at the remote sensor on the player.</li> <li>• Remove any obstacles in the path of the remote and the player.</li> <li>• Make sure the remote sensor is not exposed to strong light such as direct sunlight or fluorescent lamp light.</li> <li>• Move closer to the player when using the remote.</li> </ul>
Remote		

After trying the above remedies, if you still have problems, unplug the AC power cord and remove all the batteries. After all the indications in the display disappear, plug the power cord and insert the batteries again. If the problem persists, please consult your nearest Sony dealer.

# Maintenance

## Cleaning the tape heads and tape path

Wipe the heads, the pinch roller and the capstan with a cleaning swab slightly moistened with cleaning fluid or alcohol after every 10 hours of operation for optimum playback and recording quality. To make the best possible recording, however, we recommend that you clean all surfaces over which tape travels before each recording.

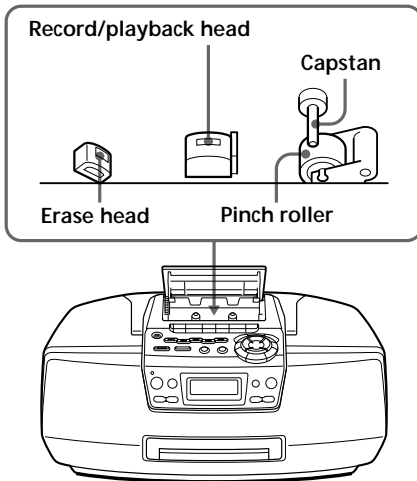

After cleaning, insert a tape when the areas cleaned are completely dry.

## Demagnetizing the tape heads

After 20 to 30 hours of use, enough residual magnetism will have built up on the tape heads to begin to cause loss of high frequency sound and hiss. At this time, you should demagnetize the heads and all metal parts in the tape path with a commercially available tape head demagnetizer.

## Cleaning the cabinet

Clean the cabinet, panel and controls with a soft cloth slightly moistened with a mild detergent solution. Do not use any type of abrasive pad, scouring powder, or solvent, such as alcohol or benzine.



# Specifications

## AUDIO POWER SPECIFICATIONS

### POWER OUTPUT AND TOTAL HARMONIC DISTORTION

With 6-ohm loads, both channels driven from 100 - 10,000 Hz; rated 3.5 W per channel-minimum RMS power, with no more than 10 % total harmonic distortion in AC operation.

## Other Specifications

### CD player section

#### System

Compact disc digital audio system

#### Laser diode properties

Material: GaAlAs

Wave length: 780 nm

Emission duration: Continuous

Laser output: Less than 44.6  $\mu$ W

(This output is the value measured at a distance of about 200 mm from the objective lens surface on the optical pick-up block with 7 mm aperture.)

#### Spindle speed

200 r/min (rpm) to 500 r/min (rpm) (CLV)

#### Number of channels

2

#### Frequency response

20 - 20,000 Hz +1/-2 dB

#### Wow and flutter

Below measurable limit

### Radio section

#### Frequency range

FM: 87.6 - 108 MHz

AM: 530 - 1,710 kHz

#### Aerials

FM: Telescopic aerial

AM: Built-in ferrite bar aerial

### Cassette-corder section

#### Recording system

4-track 2 channel stereo

#### Fast winding time

Approx. 150 sec. with Sony cassette C-60

#### Frequency response

TYPE I (normal): 80 - 10,000 Hz

## General

### Speaker

Full range: 8 cm (3 1/4 in.) dia., 6 ohms, cone type (2)

### Outputs

Headphones jack (stereo minijack)

For 16 - 68 ohms impedance headphones

### Power output (except US model)

3.5W + 3.5W (at 6 ohms, 10% harmonic distortion)

### Power requirements

For CD radio cassette-corder:

120 V AC, 60 Hz

9 V DC, 6 size D (R20) batteries

For memory back-up:

6 V DC, 4 size AA (R6) batteries

For remote control:

3 V DC, 2 size AA (R6) batteries

### Power consumption

AC 25 W

### Battery life

For CD radio cassette-corder:

---

#### FM recording

Sony R20P: approx. 3.5 h

Sony alkaline LR20: approx. 10 h

---

#### Tape playback

Sony R20P: approx. 1.5 h

Sony alkaline LR20: approx. 5 h

---

#### CD playback

Sony R20P: approx. 1 h

Sony alkaline LR20: approx. 4 h

### Dimensions

Approx. 420  $\times$  177  $\times$  281 mm (w/h/d)

(16 3/8  $\times$  7  $\times$  11 1/8 inches) (incl. projecting parts)

### Mass

Approx. 5.1 kg (11 lb. 4 oz) (incl. batteries)

### Supplied accessories

AC power cord (1)

Remote control (1)

Design and specifications are subject to change without notice.

## Optional accessories

Sony MDR headphones series

---

# Index

## A

Audio emphasis 27

## B

Batteries

- for player 26
- memory back-up 25
- for remote 26

## C

CD player 12  
Choosing power sources 25  
Cleaning

- cabinet 32
- tape heads and tape path 32

Connecting AC power cord 25  
Creating your own program 16

## D, E

Demagnetizing the tape heads 32  
Display 12

## F, G, H

FLASH 18

## I, J, K

Improving broadcast reception 7

## L

Listening to the radio 6  
Locating a specific point 13  
LOOP 18

## M, N, O

MEGA BASS 27

## P, Q

Playing

- a CD 4
- a tape 8
- preset radio stations 20
- tracks repeatedly 14

Power sources 25  
Presetting radio stations 19  
Program Play 16

## R

Radio stations

- playing 20
- presetting 19

Recording on a tape 10  
Repeat Play 14

## S

Selecting

- audio emphasis 27
- tracks 5

Setting the clock 21  
Setting up 25  
SOUND 27

## T

Timer

- Falling asleep to music 24
- Waking up to music 22

Troubleshooting 30

## U, V, W, X, Y, Z

Using the display 12



