

SONY®

3-859-548-12(1)

Compact-Hi-Fi Stereo System

Operating Instructions

Owner's Record

The model and serial numbers are located on the rear panel. Record the serial number in the space provided below. Refer to them whenever you call upon your Sony dealer regarding this product.

Model No. MHC-G202/MHC-C20

Serial No.

f

MHC-G202/MHC-C20

—
©1997 by Sony Corporation

WARNING

To prevent fire or shock hazard, do not expose the unit to rain or moisture.

To avoid electrical shock, do not open the cabinet. Refer servicing to qualified personnel only.

Do not install the appliance in a confined space, such as a bookcase or built-in cabinet.

Laser component in this product is capable of emitting radiation exceeding the limit for Class 1.

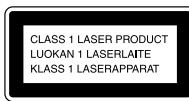

This appliance is classified as a CLASS 1 LASER product. The CLASS 1 LASER PRODUCT MARKING is located on the rear exterior.

This caution label is located inside the unit.



NOTICE FOR THE CUSTOMERS IN THE U. S. A.

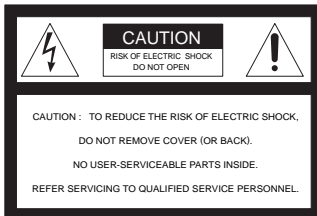

This symbol is intended to alert the user to the presence of uninsulated "dangerous voltage" within the product's enclosure that may be of sufficient magnitude to constitute a risk of electric shock to persons.



This symbol is intended to alert the user to the presence of important operating and maintenance (servicing) instructions in the literature accompanying the appliance.

CAUTION

The use of optical instruments with this product will increase eye hazard.

INFORMATION

This equipment has been tested and found to comply with the limits for a Class B digital device, pursuant to Part 15 of the FCC Rules. These limits are designed to provide reasonable protection against harmful interference in a residential installation. This equipment generates, uses, and can radiate radio frequency energy and, if not installed and used in accordance with the instructions, may cause harmful interference to radio communications. However, there is no guarantee that interference will not occur in a particular installation. If this equipment does cause harmful interference to radio or television reception, which can be determined by turning the equipment off and on, the user is encouraged to try to correct the interference by one or more of the following measures:

- Reorient or relocate the receiving antenna.
- Increase the separation between the equipment and receiver.
- Connect the equipment into an outlet on a circuit different from that to which the receiver is connected.
- Consult the dealer or an experienced radio/TV technician for help.

CAUTION

You are cautioned that any changes or modifications not expressly approved in this manual could void your authority to operate this equipment.

Note on CATV system installer:

This reminder is provided to call CATV system installer's attention to Article 820-40 of the NEC that provides guidelines for proper grounding and, in particular, specifies that the cable ground shall be connected to the grounding system of the building, as close to the point of cable entry as practical.

NOTICE FOR THE CUSTOMERS IN CANADA

CAUTION:

TO PREVENT ELECTRIC SHOCK, DO NOT USE THIS POLARIZED AC PLUG WITH AN EXTENSION CORD, RECEPTACLE OR OTHER OUTLET UNLESS THE BLADES CAN BE FULLY INSERTED TO PREVENT BLADE EXPOSURE.

Table of Contents

Getting Started

Step 1: Hooking up the system	4
Step 2: Setting the time	5
Step 3: Presetting radio stations	6
Connecting optional outdoor antennas	7
Playing a CD	9
Recording a CD	10
Listening to the radio	11
Recording from the radio	12
Playing a tape	13
Recording from a tape	14

The CD Player

Playing the CD tracks repeatedly	15
Playing the CD tracks in random order	16
Programming the CD tracks	16
Playing only the beginning of each track	17

The Tape Deck

Recording a CD by specifying track order	18
---	----

Sound Adjustment

Adjusting the sound	19
Selecting the Preset Equalizer menu .	19

Other Features

Falling asleep to music	20
Waking up to music	20

Additional Information

Precautions	22
Troubleshooting	23
Specifications	25
Index	27

Getting Started

Step 1: Hooking up the system

Do the following procedures 1 to 4 to hook up your system using the supplied cords and accessories. To complete the setup, do steps 2 and 3 also.

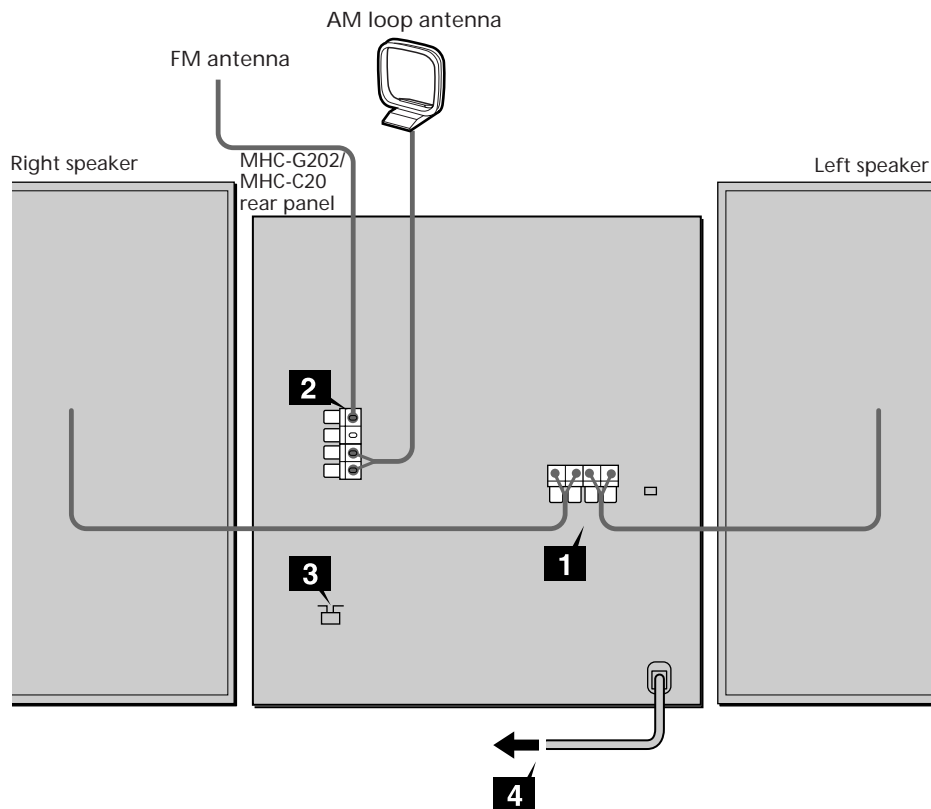

1 Connect the speakers.

Connect the speaker cords to the SPEAKER jacks of the same color .
Keep the speaker cords away from the antennas to prevent noise.

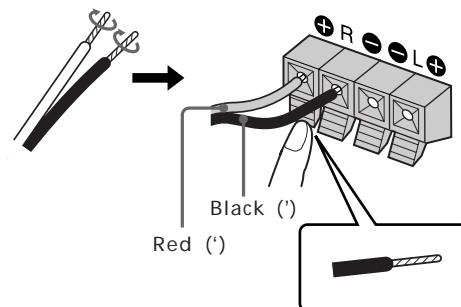

2 Connect the FM/AM antennas.

Set up the AM loop antenna, then connect it. Extend the FM lead antenna horizontally.

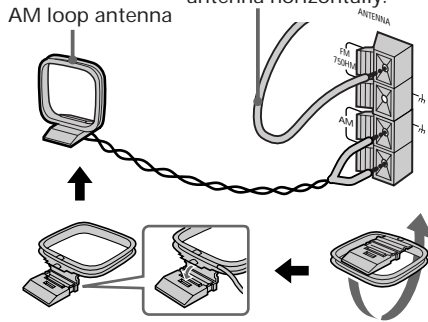

3 Set VOLTAGE SELECTOR to the position of your local power line voltage (Except for North American, Mexican, and Australian models).

VOLTAGE SELECTOR

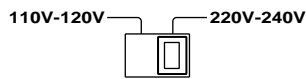

4 Connect the AC power cord to a wall outlet.

If the plug of this unit does not fit your wall outlet, detach the supplied adapter from the plug (Except for North American models).

Inserting two R03 (size AAA) batteries into the remote

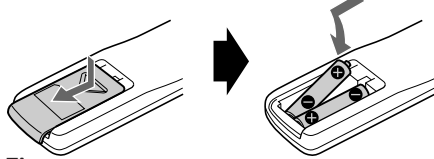

Tip

With normal use, the batteries should last for about six months. When the remote no longer operates the system, replace both batteries with new ones.

Note

If you do not use the remote for a long period of time, remove the batteries to avoid possible damage from battery leakage.

Step 2: Setting the time

You must set the time beforehand to use the timer function.

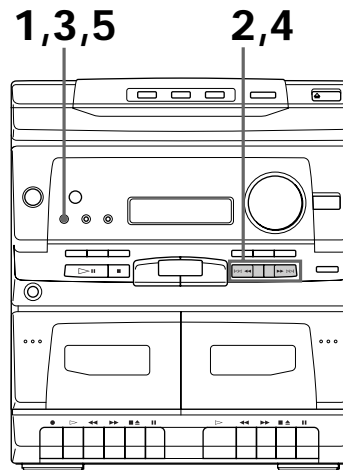

1 Press CLOCK SET for a few seconds, when the power is off.
“--:--” appears.

2 Press)± or 0 and set the hour.
“A” indicates AM and “P” indicates PM.

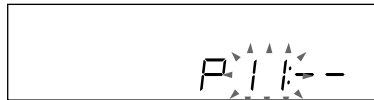

3 Press CLOCK SET.
The minute indication flashes.

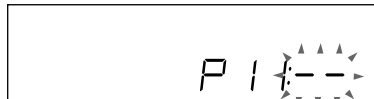

4 Press)± or 0 and set the minute.

continued

Setting the time (continued)

5 Press CLOCK SET.

The clock starts working.

To light up the display

Press TIMER SET when the power is off. The light on the display turns on for five seconds.

To check the clock when the power is on

Press CLOCK SET. The clock is displayed for a few seconds.

Step 3: Presetting radio stations

You can preset up to 30 stations.

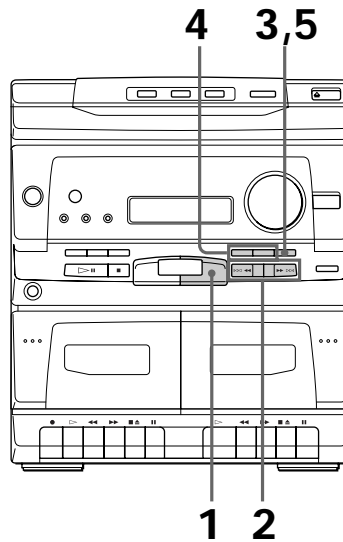

1 Press TUNER/BAND repeatedly until the band you want appears in the display.

Each time you press the button, the band changes as follows:

FM ~ AM

2 Press)± or 0 for a second.

The frequency indication changes and scanning stops when the system tunes in a station. "TUNED" and "STEREO" (for a stereo program) appear.

3 Press MEMORY.

"MEMORY" flashes.

- 4** Press PRESET + or – and select the preset number you want.

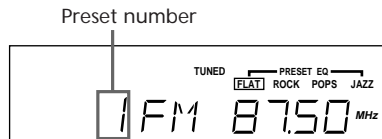

- 5** Press MEMORY.
The station is stored.

- 6** Repeat steps 1 to 5 to store other stations.

To tune in a station with a weak signal

Press)± or 0 repeatedly to tune in the station.

To change the preset number

Start again from step 1.

To change the AM tuning interval (except for North American, Mexican, Australian and Middle Eastern models)

The AM tuning interval is factory-preset to 9 kHz (10 kHz in some areas). To change the AM tuning interval, turn off the power and change the position of the AM TUNING STEP switch on the rear panel to 10 kHz (or 9 kHz). Then turn the power back on. To reset the interval, repeat the same procedure.

Tip

The preset stations are retained for a week even if you pull out the AC power cord or if a power failure occurs.

Connecting optional outdoor antennas

Connect the outdoor antenna to improve the reception.

FM antenna

Connect the optional FM outdoor antenna. You can also use the TV antenna instead.

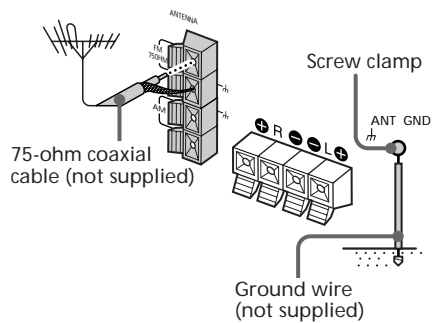

Connecting optional outdoor antennas (continued)

AM antenna

Connect a 6- to 15- meter (20- to 50- feet) insulated wire to the AM antenna terminal. Leave the supplied AM loop antenna connected.

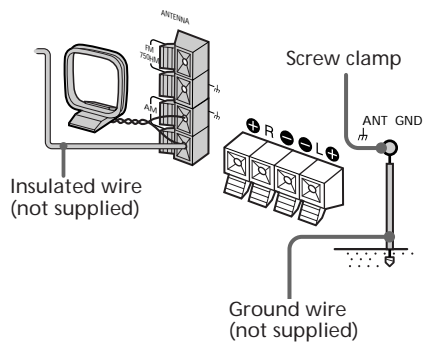

Important

Ground the external antenna from y terminal against lightning. To prevent a gas explosion, do not connect the ground wire to a gas pipe.

Basic Operations

Playing a CD

You can play up to three CDs continuously.

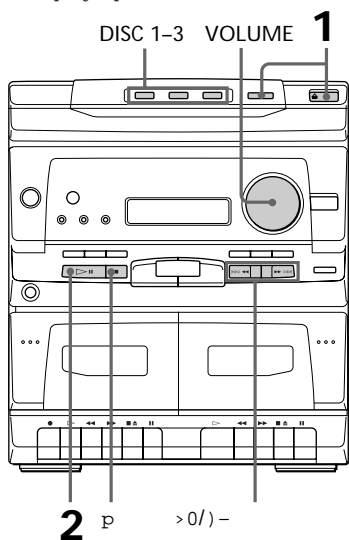

- 1 Press **P** and place a CD on the disc tray.

With the label side up. When you play a single CD, place it on the inner circle of the tray.



To place the third disc, press DISC SKIP to rotate the disc tray.

- 2 Press **P**.

The disc tray closes and play starts from the CD loaded on the tray whose button is lit green.

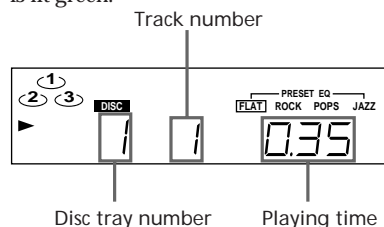

To	Do this
Stop play	Press p .
Pause	Press -P . Press again to resume play.
Select a track	Press)± or 0 (or + or = on the remote).
Find a point in a track	Press and hold down)± or 0 during play and release it at the desired point.
Select a CD	Press DISC 1 - 3 or DISC SKIP .
Remove or exchange the CD	Press § .
Adjust the volume	Turn VOLUME (or press VOL + or - on the remote).

Tips

- Pressing **-P** when the power is off automatically turns the power on and starts CD playback if there is a CD on the tray (One Touch Play).
- You can switch from another source to the CD player and start playing a CD just by pressing **-P** (Automatic Source Selection).
- When the disc tray is selected or the CD loaded on the tray is playing, the DISC 1 - 3 button for the tray is lit green.

Recording a CD

Use a TYPE I (normal) tape.

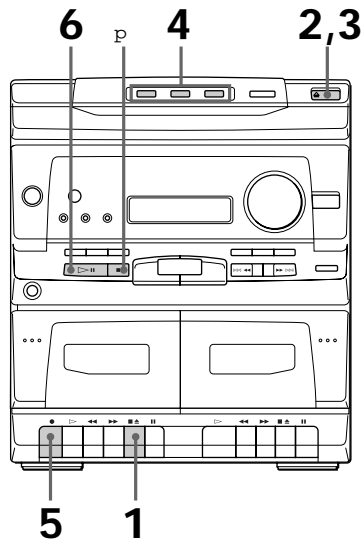

- 1 Press **p6** and insert a blank tape into deck A.

With the side you want to record on facing forward

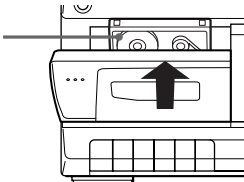

- 2 Press **§** and insert a CD on the disc tray.

With the label side up. When you play a single CD, place it on the inner circle of the tray.

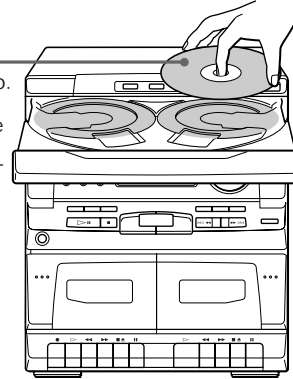

- 3 Press **§**.
The disc tray closes.
- 4 Press one of the **DISC 1 - 3** buttons to select a CD.
- 5 Press **r** on deck A.
Recording starts.
- 6 Press **.P.**
CD play starts.

To stop recording

Press **p6** on deck A and **p** on the CD player.

Note

You cannot listen to other sources while recording.

Listening to the radio

-- Preset Tuning

Firstly preset radio stations in the tuner's memory (see page 6).

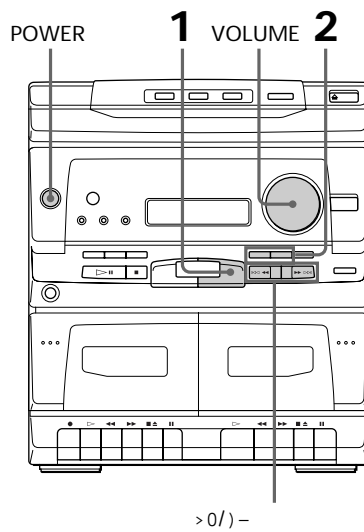

- 1 Press **TUNER/BAND** repeatedly until the band you want appears. Each time you press the button, the band changes as follows:

FM ~ AM

- 2 Press **PRESET + or -** to tune in the desired preset station.

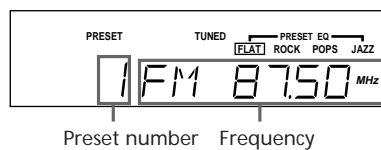

To	Do this
Turn off the radio	Press POWER .
Adjust the volume	Turn VOLUME (or press VOL + or - on the remote).

To listen to non-preset radio stations

Press **)±** or **0** repeatedly to tune in the desired station.

Tips

- Pressing **TUNER/BAND** when the power is off automatically turns the power on and tunes to the last received station (One Touch Play).
- You can switch from another source to the tuner just by pressing **TUNER/BAND** (Automatic Source Selection).
- To improve broadcast reception, reorient the supplied antennas.

Recording from the radio

You can record the radio program on a tape by calling up a preset station. Use a TYPE I (normal) tape.

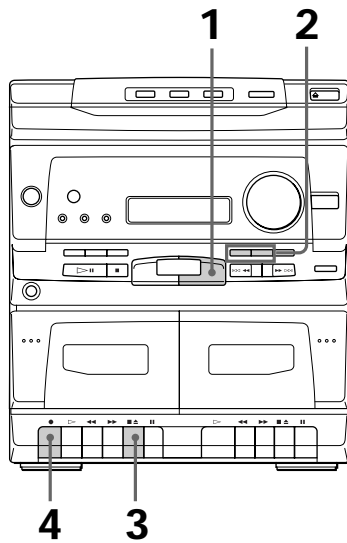

- 1** Press TUNER/BAND to select the band you want.
- 2** Press PRESET + or - to tune in a preset station.
- 3** Press p6 and insert a blank tape into deck A.

With the side you want to record on facing forward

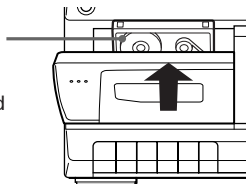

- 4** Press r. Recording starts.

To stop recording

Press p6 on deck A.

Tips

- To record non-preset stations, press \pm or 0 repeatedly to tune in the desired station.
- If noise is heard while recording an AM radio, move the AM antenna to reduce the noise.

Playing a tape

Use a TYPE I (normal) tape.

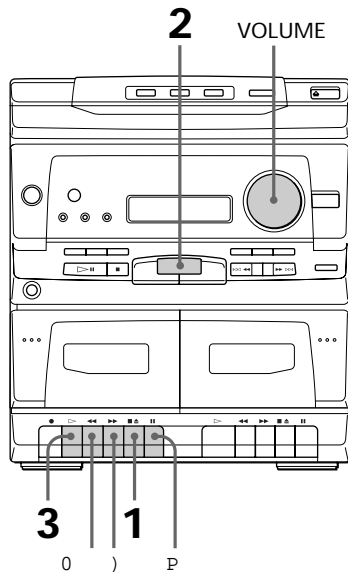

- 1 Press p6 and insert a recorded tape in deck A or B.

With the side you want to play facing forward

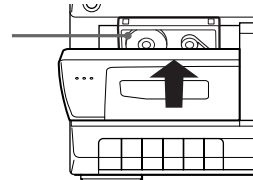

- 2 Press TAPE.
"TAPE" appears in the display.

- 3 Press .
The tape starts playing*.

* The deck stops automatically when the playback of the tape ends.

To play both decks in succession (relay play)

You can listen to one side of the tapes in deck B and deck A in succession.

When the tape in deck B finishes playing, the tape in deck A starts playing.

- 1 Press p6 on deck B and insert a recorded tape in deck B.
- 2 Press . on deck B. The tape on deck B starts playback.
- 3 Press p6 on deck A and insert a recorded tape in deck A.
- 4 Press P and . on deck A. The tape on deck A is paused and automatically released when the playback on deck B ends.

To	Do this
Stop play	Press p6.
Pause	Press P. Press again to resume play.
Fast-forward	Press p6 then press).
Rewind	Press 0.
Remove the cassette	Press p6.
Adjust the volume	Turn VOLUME (Press VOL + or - on the remote).

Tip

If you play both decks at the same time, you'll hear the sound from deck B.

Recording from a tape

— Dubbing

Use a TYPE I (normal) tape.

To stop recording

Press p6 on deck A and B.

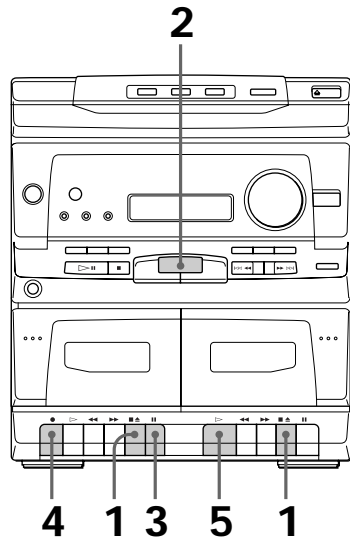

- 1** Press p6 and insert a blank tape in deck A and a recorded tape in deck B.

With the side you want to play/record on facing forward

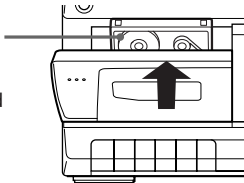

- 2** Press TAPE.
"TAPE" appears in the display.
- 3** Press P on deck A.
- 4** Press r on deck A.
Deck A stands by for recording.
- 5** Press · on deck B.
The tape starts dubbing.

The CD player

Playing the CD tracks repeatedly

-- Repeat Play

This function lets you repeat a single CD or all CDs in normal play, Shuffle Play and Program Play.

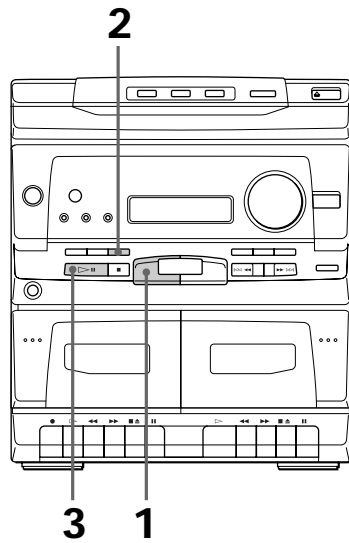

1 Press CD and place a CD on the disc tray.

2 Press REPEAT.

3 Press .P.
Repeat Play starts. Do the following procedure to change the repeat mode.

To repeat	Press
Only one track	REPEAT repeatedly until "REPEAT 1" appears in the display while playing the track you want to repeat.
All the tracks on the current CD	REPEAT repeatedly until "REPEAT 1 DISC" appears in the display.
All the tracks on all CDs	REPEAT repeatedly until "REPEAT ALL DISC" appears in the display.

To cancel Repeat Play

Press REPEAT so that "REPEAT", "REPEAT 1" or "REPEAT ALL DISC" disappears from the display.

Playing the CD tracks in random order

-- Shuffle Play

You can play all the tracks on one CD or all CDs in random order.

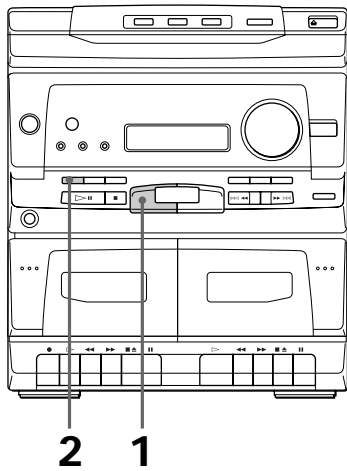

1 Press CD and place a CD on the disc tray.

2 Press SHUFFLE.
"SHUFFLE" appears, then all the tracks play in random order.

To cancel Shuffle Play

Press SHUFFLE so that "SHUFFLE" disappears.

Tips

- You can start Shuffle Play during normal play by displaying "SHUFFLE".
- To skip a track, press)±.

Note

You cannot select a CD even if you press DISC SKIP while shuffle play.

Programming the CD tracks

-- Program Play

You can make a program of up to 32 tracks from all the CDs in the order you want them to be played.

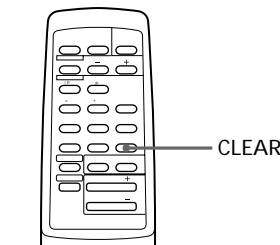
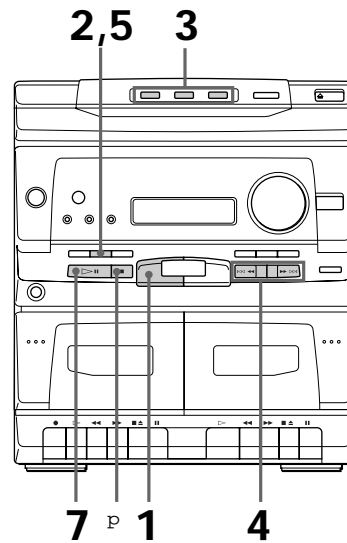

1 Press CD and place a CD on the disc tray.

2 Press PROGRAM.
"PROGRAM" appears.

3 Press one of the DISC 1 - 3 buttons to select a CD.

- 4** Press **)±** or **0** to select a track.

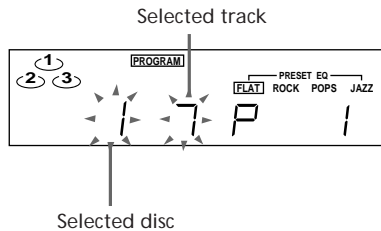

- 5** Press **PROGRAM**.

The track is programmed. The last programmed track appears.

- 6** To program additional tracks, repeat steps 3 to 5.

Skip step 3 if you select a track from the same disc.

- 7** Press **.P.**

All the tracks play in the order you selected.

To	Press
Program a pause	. P
Stop play	p
Cancel program play	p
Erase a track from the end	CLEAR on the remote in stop mode
Erase the entire program	p for more than two seconds

Tips

- The program you made remains after the Program Play has finished. To play the same program again, press **.P.**
- "FULL" appears when you have programmed more than 32 track numbers.

Playing only the beginning of each track

— Music Scan

The beginning of each track on all the CDs in the CD tray play for 10 seconds.

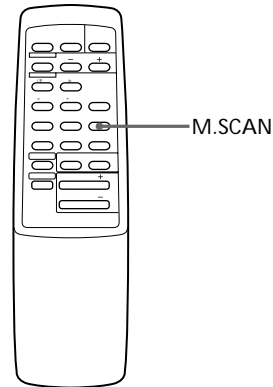

To play only the beginning of each track

Press **M. SCAN** on the remote.

Track number blinks during the scanning.

To cancel music scan

Press **M. SCAN** on the remote again.

The Tape Deck

Recording a CD by specifying track order

-- Program Edit

You can record tracks from all the CDs in the order you want. When programming, make sure the playing times for each side do not exceed the length of one side of the tape.

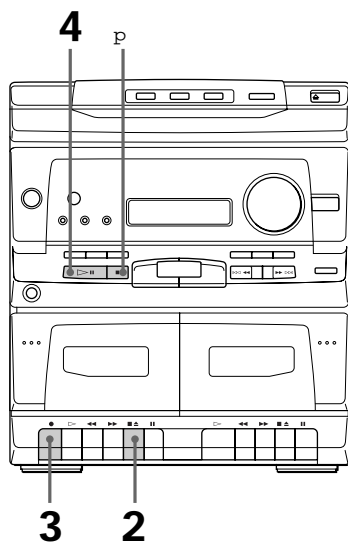

- 4 Press **P**.
CD play starts.

To stop recording

Press **p6** on deck A and **p** on the CD player.

To cancel Program Edit

Press **PROGRAM** so that "PROGRAM" disappears.

- 1 Follow step 1 - 6 in "Programming the CD tracks" (see p.16).

- 2 Press **p6** and insert a blank tape into deck A.

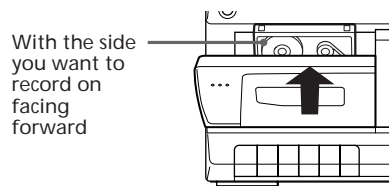

- 3 Press **r**.
Recording starts.

Sound Adjustment

Adjusting the sound

You can listen to music with strong bass.

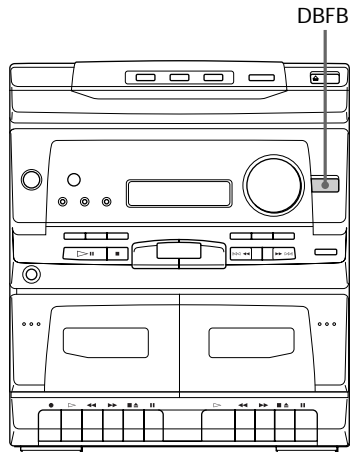

To reinforce the bass sound

Press DBFB (Dynamic Bass Feedback).

The lamp on the button lights up.

Press the button again to cancel DBFB.

Selecting the Preset Equalizer menu

The Preset Equalizer enables you to select the sound characteristic among four sound effects according to the sound you are listening to.

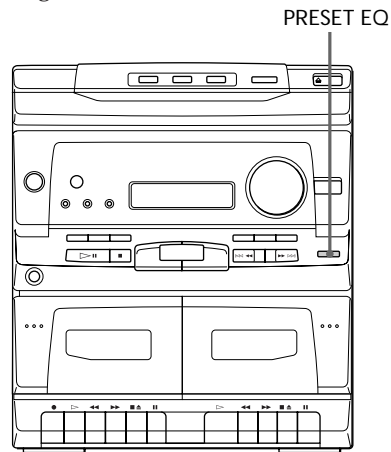

To select the sound characteristic

Press PRESET EQ repeatedly to select your desired sound effect.

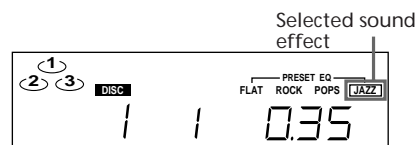

To cancel the Preset Equalizer

Press PRESET EQ until "FLAT" is selected.

Tip

The Preset Equalizer effect is not recorded on a tape.

Other Features

Falling asleep to music

— Sleep Timer

You can let the system turn off at a preset time, so you can sleep to the music. You can preset the time to be turned off by 10 minutes.

Make sure you have set the clock (see page 5).

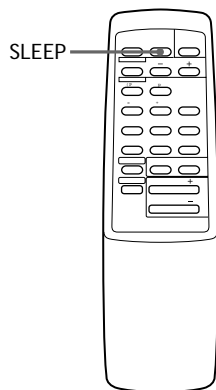

Press SLEEP on the remote.

"SLEEP" appears.

Each time you press the button, the minute display (the turn-off time) changes as follows:

SLEEP 90 n 80 n 70 n... n 10
 z _____ (Sleep off) _____

To check the remaining time

Press SLEEP once.

To change the time to turn off

Select the time you want by pressing SLEEP.

To cancel the Sleep Timer function

Press SLEEP repeatedly until "SLEEP" disappears.

Waking up to music

— Wake-up Timer

You can wake up to music at a preset time.

Make sure you have set the clock (see page 5).

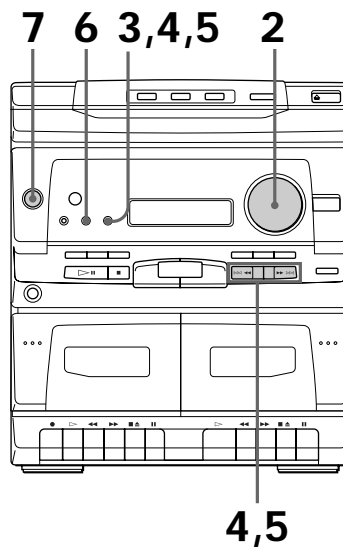

1 Prepare the music source you want to play.

- CD: Place a CD.
- Radio: Tune in a station (see page 11).

2 Turn VOLUME to adjust the sound volume.

3 Press TIMER SET.

4 Set the time to start play.

Press)± or 0 to set the hour, then press TIMER SET.

The minute indication starts flashing.



Press)± or 0 to set the minute, then press TIMER SET.

The hour indication flashes again.

5 Set the time to stop playback.

Press)± or 0 to set the hour, then press TIMER SET.
The minute indication starts flashing.

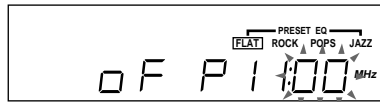

Press)± or 0 to set the minute, then press TIMER SET.
The start time, followed by the stop time, the music source and volume appear, then the original display appears.

6 Press TIMER MODE.

"TIMER" appears.

7 Press POWER to turn off the power.

To check the setting

Press TIMER SET. The start time and the stop time appears. To change the setting, start again from step 1.

To cancel the timer operation

Press TIMER MODE.
"TIMER" disappears.

Note

Do not operate the system from the time the power turns on until the playback starts (about 20 seconds).

Additional Information

Precautions

On operating voltage

Before operating the system, check that the operating voltage of your system is identical with the voltage of your local power supply.

On safety

- The unit is not disconnected from the AC power source (mains) as long as it is connected to the wall outlet, even if the unit itself has been turned off.
- Unplug the system from the wall outlet (mains) if it is not to be used for an extended period of time. To disconnect the cord (mains lead), pull it out by the plug. Never pull the cord itself.
- Should any solid object or liquid fall into the component, unplug the stereo system and have the component checked by qualified personnel before operating it any further.
- The mains lead must be changed only at a qualified service shop.

On placement

- Place the stereo system in a location with adequate ventilation to prevent heat build-up in the stereo system.
- Do not place the unit in an inclined position.
- Do not place the unit in locations where it is;
 - Extremely hot or cold
 - Dusty or dirty
 - Very humid
 - Vibrating
 - Subject to direct sunlight.

On operation

- If the stereo system is brought directly from a cold to a warm location, or is placed in a very damp room, moisture may condense on the lens inside the CD player. Should this occur, the system will not operate properly. Remove the CD and leave the system turned on for about an hour until the moisture evaporates.
- When you move the system, take out the disc.

If you have any questions or problems concerning your stereo system, please consult your nearest Sony dealer.

On the speaker system

Locate the speaker system further away from the TV set. Furthermore, be sure not to place objects in which magnets are attached or used near the TV set, such as audio racks, TV stands, toys etc. These may cause magnetic distortion to the picture due to their interaction with the system.

Notes on CDs

- Before playing, clean the CD with a cleaning cloth. Wipe the CD from the center out.
- Do not use solvents such as benzene, thinner, commercially available cleaners or anti-static spray intended for vinyl LPs.
- Do not expose the CD to direct sunlight or heat sources such as hot air ducts, nor leave it in a car parked in direct sunlight.

Cleaning the cabinet

Use a soft cloth slightly moistened with mild detergent solution.

To save a tape permanently

To prevent a tape from being accidentally recorded over, break off the cassette tab from side A or B as illustrated. If you later want to reuse the tape for recording, cover the broken tab with adhesive tape.

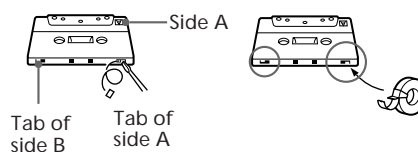

Before placing a cassette in the tape deck

Take up any slack in the tape. Otherwise the tape may get entangled in the parts of the tape deck and become damaged.

When using a tape longer than 90 minutes

The tape is very elastic. Do not change the tape operations such as play, stop, and fast-winding etc. frequently. The tape may get entangled in the tape deck.

Cleaning the tape heads

Clean the tape heads after every 10 hours of use.
When the tape heads become dirty

- the sound is distorted
- there is a decrease in sound level
- the sound drops out
- the tape does not erase completely
- the tape does not record

Make sure to clean the tape heads before you start an important recording or after playing an old tape. Use separately sold dry-type or wet-type cleaning cassette. For details, refer to the instructions of the cleaning cassette.

Demagnetizing the tape heads

Demagnetize the tape heads and the metal parts that have contact with the tape every 20 to 30 hours of use with a separately sold demagnetizing cassette. For details, refer to the instructions of the demagnetizing cassette.

Troubleshooting

If you run into any problem using this stereo system, use the following check list.

First, check that the mains lead is connected firmly and the speakers are connected correctly and firmly.

Should any problem persist, consult your nearest Sony dealer.

General

There is no sound.

- Rotate VOLUME clockwise.
- The headphones are connected.

There is severe hum or noise.

- A TV or VCR is placed too close to the stereo system. Move the stereo system away from the TV or VCR.

The timer does not function.

- Set the clock correctly.

The remote does not function.

- There is an obstacle between the remote and the system.
- The remote is not pointing in the direction of the system's sensor.
- The batteries have run down. Replace the batteries.

The color irregularity on a TV screen persists.

- Place the speakers farther away from the TV set.

Speakers

Sound comes from one channel or unbalanced left and right volume.

- Check the speaker connection and speaker placement.

continued

Troubleshooting (continued)

CD Player

The CD tray does not close. _____

- The CD is not placed properly.

The CD will not play. _____

- The CD is dirty.
- The CD is inserted label side down.
- Moisture condensation has built up. Remove the CD and leave the system turned on for about an hour until the moisture evaporates.

Play does not start from the first track. _____

- The player is in program or shuffle mode. Press SHUFFLE or PROGRAM so that "SHUFFLE" or "PROGRAM" disappears.

Tape Deck

The tape does not record. _____

- No tape in the cassette holder.
- The tab has been removed from the cassette (see "To save a tape permanently" on page 22).
- The tape has reeled to the end.

The tape does not record nor play or there is a decrease in sound level. _____

- The heads are dirty. Clean them (see "Cleaning the tape heads" on page 23).
- The record/playback heads are magnetized. Demagnetize them (see "Demagnetizing the tape heads" on page 23).

The tape does not erase completely. _____

- The record/playback heads are magnetized. Demagnetize them (see "Demagnetizing the tape heads" on page 23).

There is excessive wow or flutter, or the sound drops out. _____

- The capstans or pinch rollers are dirty. Clean them (see "Cleaning the tape heads" on page 23).

Noise increases or the high frequencies are erased. _____

- The record/playback heads are magnetized. Demagnetize them (see "Demagnetizing the tape heads" on page 23).

Tuner

Severe hum or noise ("TUNED" or "STEREO" flashes in the display. _____

- Adjust the antenna.
- The signal strength is too weak. Connect the external antenna.

If the system malfunctions due to a cause other than the ones mentioned above

This system coordinates its performance by using built-in microcomputer chips. Therefore there may be a case where the system does not operate properly if the condition of its power source etc. is unstable. In such a case, turn the system's power off and then turn it on again. If the system still does not operate properly, consult your nearest Sony dealer.

Specifications

For the U.S. model

AUDIO POWER SPECIFICATIONS

POWER OUTPUT AND TOTAL HARMONIC DISTORTION:

With 6 ohm loads, both channels driven, from 70 – 20,000 Hz; rated 32 watts per channel minimum RMS power, with no more than 0.9% total harmonic distortion from 250 milliwatts to rated output.

Amplifier section

Continuous RMS power output	40 + 40 watts (6 ohms at 1 kHz, 10% THD)
Music power output (North American model only)	75 + 75 W
Peak music power output (Except for North American models)	550 watts
Outputs	PHONES (stereo phone jack): accepts headphones of 8 ohms or more. SPEAKER: accepts impedance of 6 to 16 ohms.

CD player section

System	Compact disc and digital audio system
Laser	Semiconductor laser ($\lambda=780 - 790$ nm) Emission duration: continuous
Laser output	Max. $400\mu\text{W}^*$ *This output is the value measured at a distance of 200 mm from the objective lens surface on the Optical Pick-up Block with 7 mm aperture.
Frequency response	40 Hz – 16 kHz (± 0.5 dB)

Tape player section

Recording system	4-track 2-channel stereo
Frequency response	60 – 13,000 Hz (± 3 dB), using Sony TYPE I cassette
Wow and flutter	0.1% WRMS $\pm 0.3\%$ (DIN)

Tuner section

FM stereo, FM/AM superheterodyne tuner

FM tuner section

Tuning range	87.5 – 108.0 MHz
Antenna	FM lead antenna
Antenna terminals	75 ohm unbalanced
Intermediate frequency	10.7 MHz

AM tuner section

Tuning range	North American and Mexican models: 530 – 1,710 kHz (with the tuning interval set at 10 kHz) Australian model: 531 – 1,602 kHz (with the tuning interval set at 9 kHz) Other models: 531 – 1,602 kHz (with the tuning interval set at 9 kHz) 530 – 1,710 kHz (with the tuning interval set at 10 kHz)
Antenna	AM loop antenna External antenna terminals
Intermediate frequency	450 kHz

Speaker

SS-G20 (For MHC-G202)	
SS-G15 (For MHC-C20)	
Speaker system	2-way, bass-reflex type
Speaker units	
Woofer:	13 cm dia., cone type
Tweeter:	2 cm dia., PIEZO type
Nominal impedance	6 ohms
Dimensions:	Approx. 220 x 320 x 197 mm ($8\frac{3}{4}$ x $12\frac{5}{8}$ x $7\frac{7}{8}$ in) (w/h/d) incl. projecting parts and controls
Mass:	Approx. 2.5 kg (5 lb 8 oz) net per speaker

continued

Specifications (continued)

General

Power requirements	North American models: 120 V AC, 60 Hz Mexican models: 120 V AC, 50/60 Hz Australian models: 220 – 240 V AC, 50/60 Hz Other models: 110 – 120 V or 220 – 240V AC, 50/ 60 Hz adjustable with voltage selector
Power consumption	195 watts
Dimensions	Approx. 280 × 320 × 340 mm (11 ¹ / ₈ × 12 ⁵ / ₈ × 13 ¹ / ₂ in) (w/h/d) incl. projecting parts and controls
Mass	Approx. 7.1 kg (15 lb 10 oz)
Supplied accessories:	AM loop antenna (1) Remote RM-SG20 (1) FM lead antenna (1)

Design and specifications are subject to change
without notice.

Index

Adjusting

- the sound 19
- the volume 9

Antennas 5, 7

Automatic Source Selection
9

Batteries 5

CD player 9, 15

Clock setting 5

Connecting. *See* Hooking up

DBFB 19

Display 5, 6

Hooking up

- the antennas 5, 7
- the power 5
- the system 4

M. Scan 17

One Touch Play 9, 11

Playing

a CD 9

a preset radio station 11

a tape 13

tracks in random order

(Shuffle Play) 16

tracks in the desired
order (Program Play) 16

tracks repeatedly
(Repeat Play) 15

Preset equalizer menu 19

Presetting radio stations 6

Preset tuning 11

Program Play 16

Protecting recordings 22

Radio stations

presetting 6

tuning in 11

Recording

a CD 10

a radio program 12

a tape 14

Repeat Play 15

Saving recordings 22

Setting the time 5

Shuffle Play 16

Sleep Timer 20

Sound adjustment 19

Speakers 4

Timer

falling asleep to music
20

waking up to music 20

Troubleshooting 23

Tuner 6, 11, 12

Wake-up timer 20

Sony Corporation Printed in China

MHC-G202/C20. 3-859-548-12. EN