

Trinitron[®] Color TV

Operating Instructions _____ **EN**

_____ **C1**

_____ **C2**

KV-V28

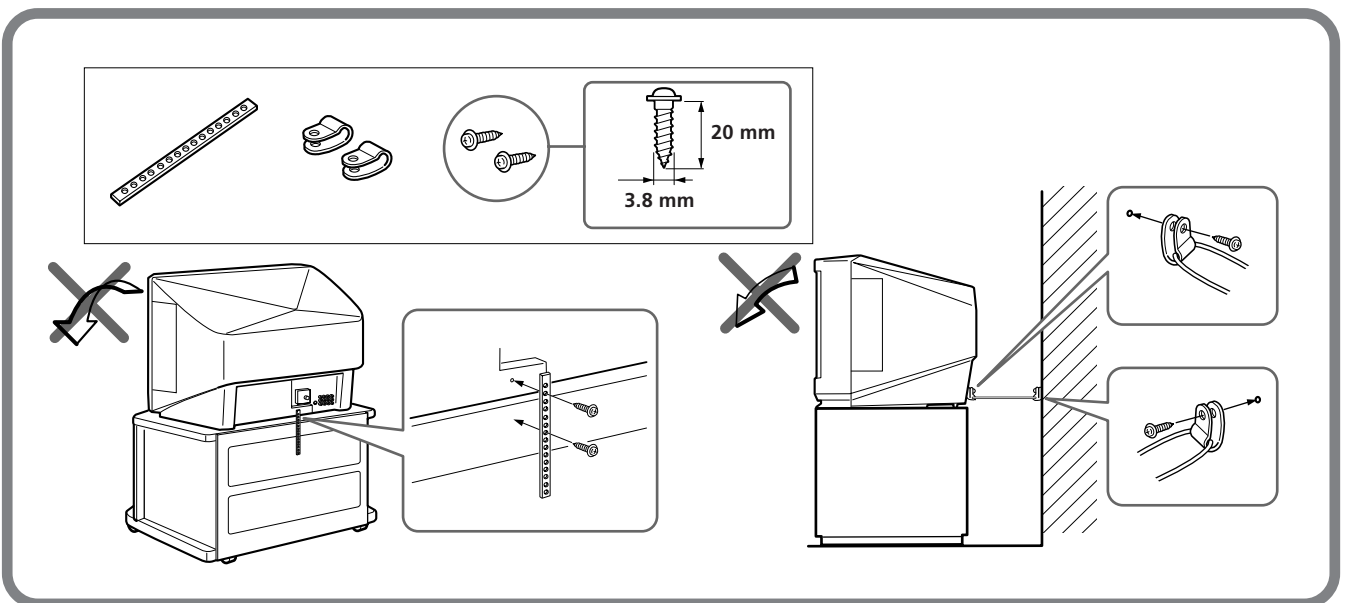
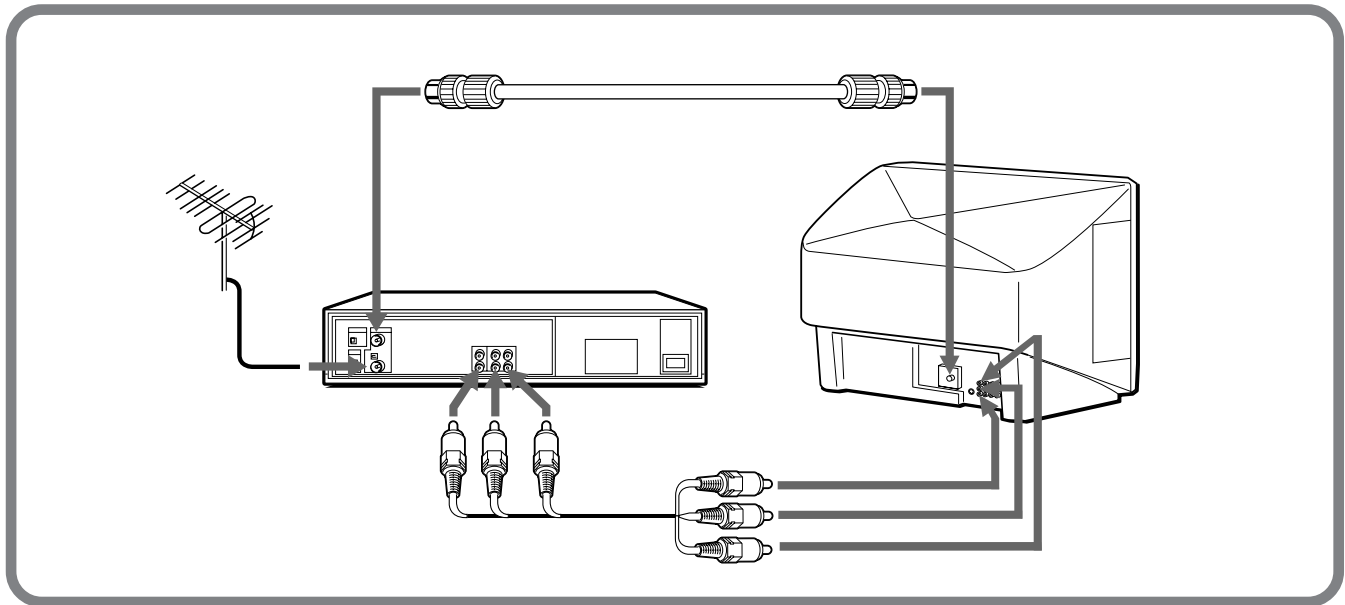
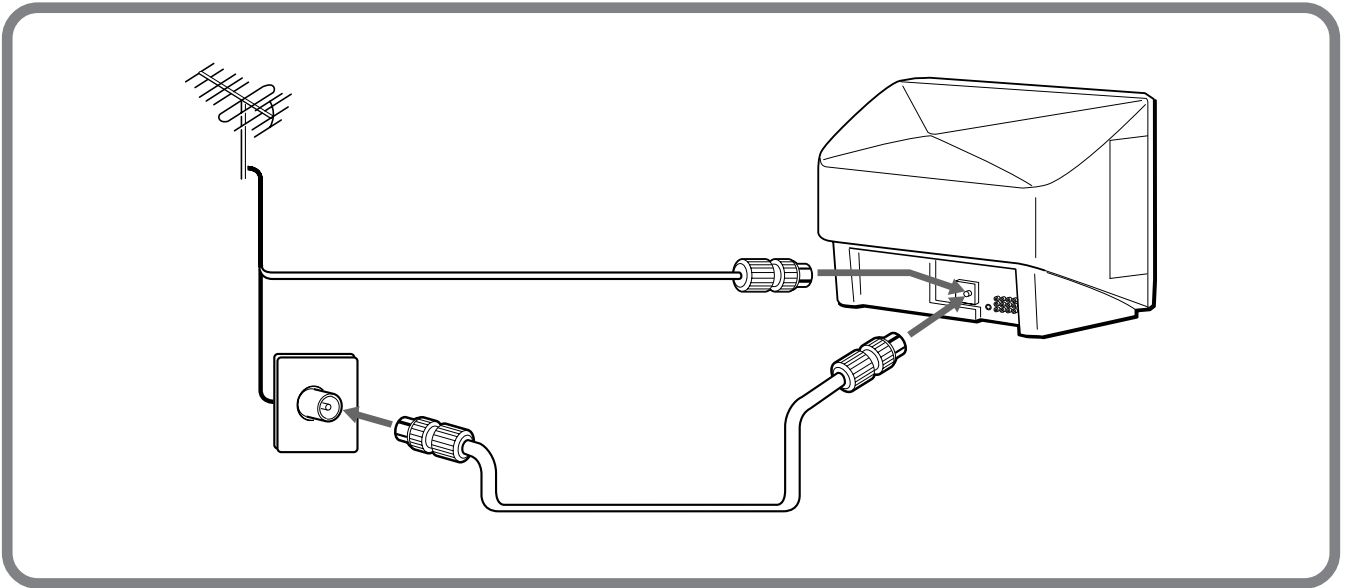

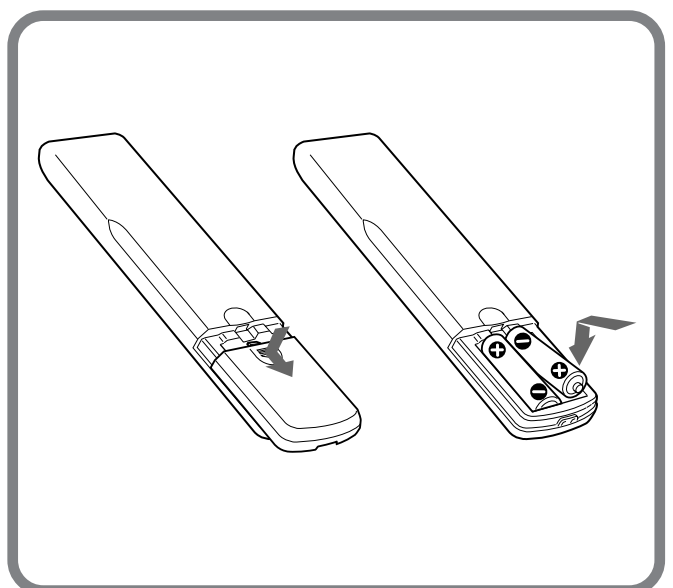
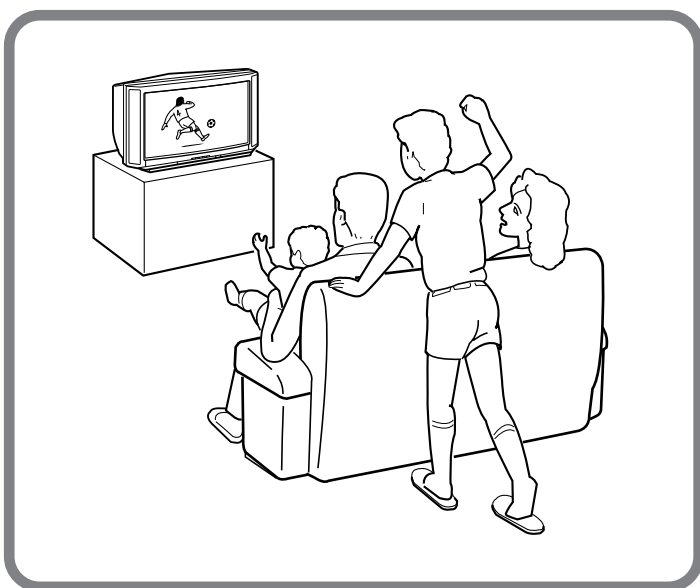
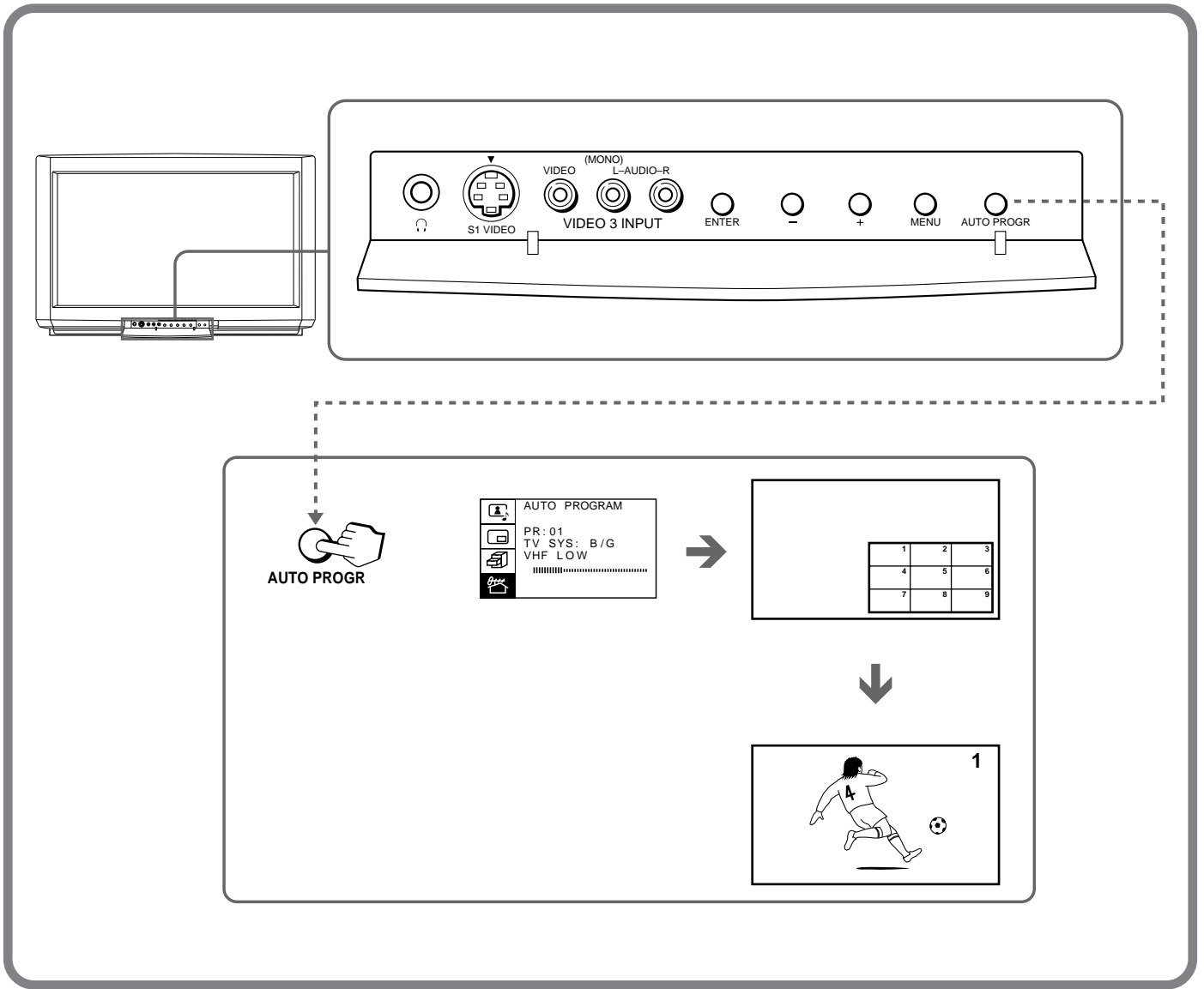

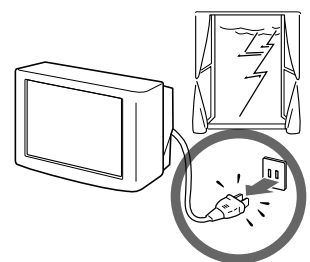
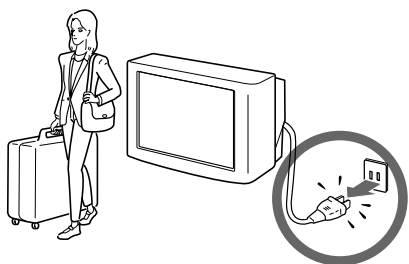
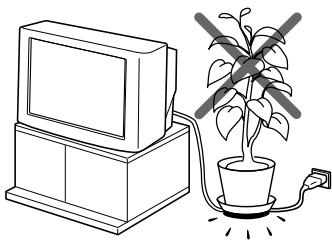
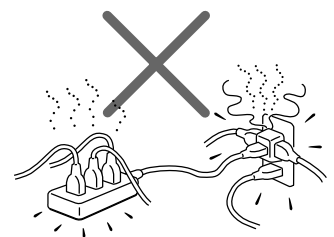
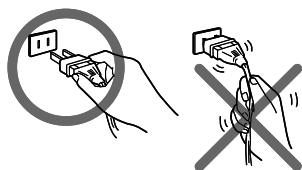
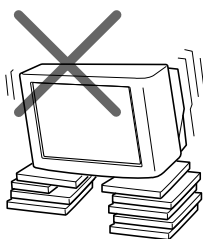
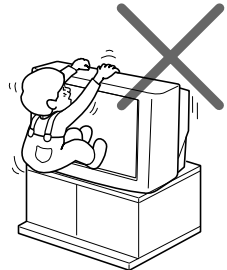
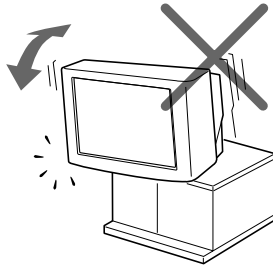
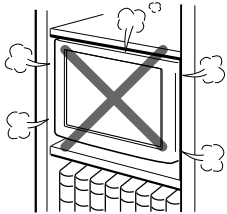
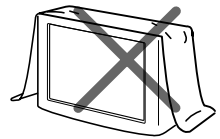
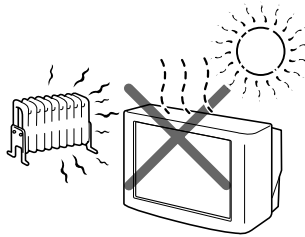
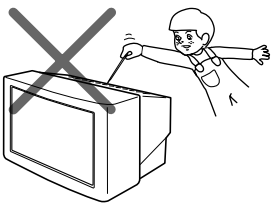
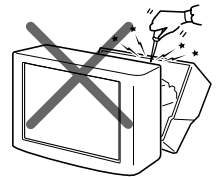
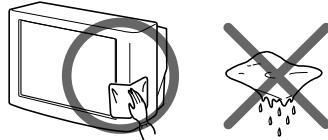
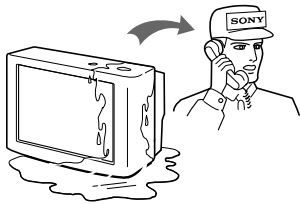
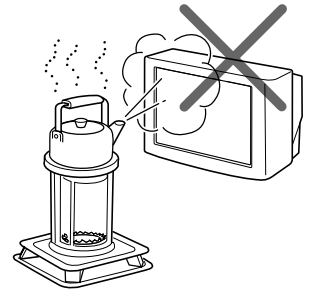
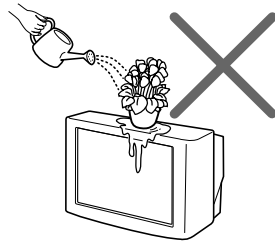
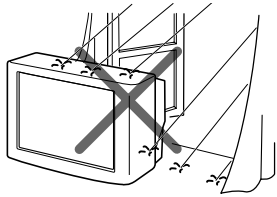

WARNING

- Dangerously high voltages are present inside the TV.
- Operate the TV only at 110-240 V AC.
- Do not open the cabinet and the rear cover of the TV. Refer servicing to qualified personnel.
- To prevent fire or shock hazard, do not expose the TV to rain or moisture.
- Do not operate the TV if any liquid or solid object falls into it. Have it checked immediately by qualified personnel only.
- Do not block the ventilation openings.
- Do not install the appliance in a confined space, such as a bookcase or built-in cabinet.
- Do not install the TV in hot, humid or excessively dusty places.
- Do not install the TV where it may be exposed to mechanical vibrations.
- Do not keep the TV plugged in if you are not going to use it for several days.
- Do not pull the power cord to disconnect the TV. Pull it out by the plug.
- Use only the supplied screws (as shown on page 2) to fasten the TV to the TV stand or to stabilize the TV against a wall or a pillar. Use of other screws may damage the TV.

Note on the remote commander

- The supplied remote commander is used on several models of the TV. If you do not find instructions for some controls that are on the remote commander, that means your TV does not employ the features of those controls, e.g. TEXT.

Notes

- When you turn on the TV, you may hear the "boon" sound that is caused by the demagnetization of the TV. This does not indicate a malfunction.
- The picture color may become abnormal if you change the direction of your TV. To obtain the normal picture color, press POWER on the TV to turn off the TV for five minutes and then turn it on again.

Table of contents

Getting Started

- 6 Connections
- 8 Getting to know the remote commander
- 9 Introducing the menus
- 10 Changing the menu language
- 11 Presetting channels

Operations

- 13 Watching the TV
- 16 Watching the picture in wide mode (WIDE MODE)
- 17 Scrolling a picture up or down (SCROLL)
- 18 Adjusting the picture and sound
- 20 Listening to the POWER BASSO sound
- 21 Listening to the surround sound (HYPER SURROUND)
- 22 Selecting a stereo or bilingual program
- 23 Viewing multiple programs at the same time (PROGRAM INDEX)
- 24 Displaying frame-by-frame pictures (STROBE)
- 24 Using the Picture-in-Picture (PIP) features
- 26 Viewing Teletext
- 28 Displaying Teletext on the PIP screen (PIP TEXT)
- 29 Viewing a video game screen
- 30 Customizing the TV

EN

Additional Information

- 31 Troubleshooting
- Back cover Specifications

All contents are subject to change without notice.
Design and specifications are subject to change without notice.

Connections

Connecting a VHF antenna or a combination VHF/UHF antenna — 75-ohm coaxial cable (round)

Attach an optional IEC antenna connector to the 75-ohm coaxial cable. Plug the connector into the Υ (antenna) socket at the rear of the TV.

Rear of TV

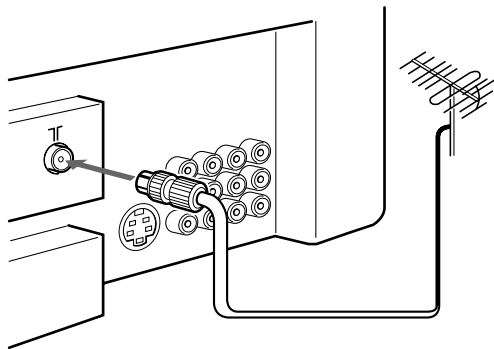

Rear of TV

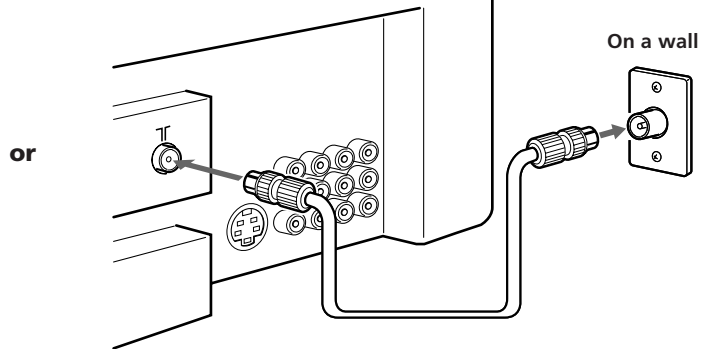

Connecting optional equipment

You can connect optional audio/video equipment to your TV such as a VCR, multi disc player, camcorder, video game or stereo system.

Connecting video equipment using video input jacks

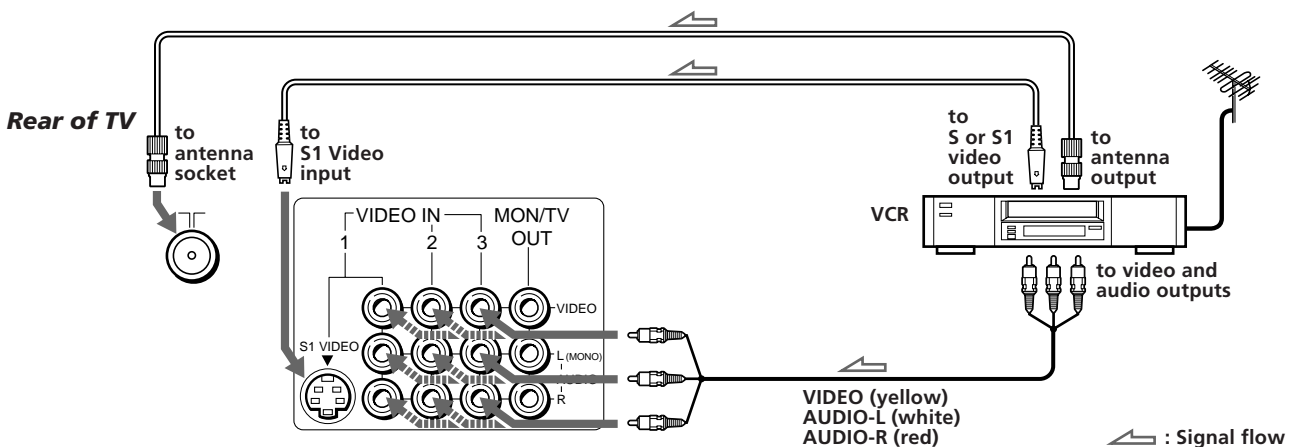

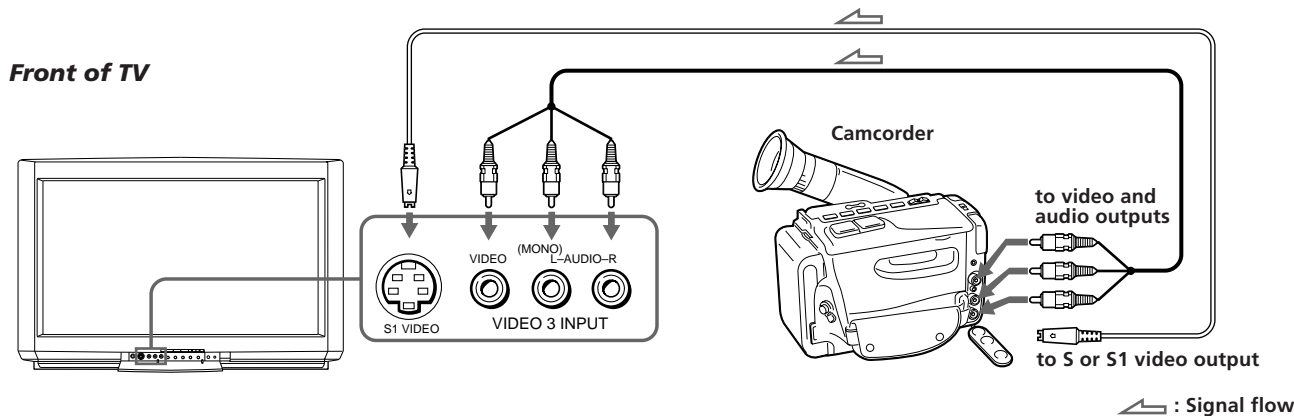

When connecting a monaural VCR

Connect the yellow plug to VIDEO and the black plug to AUDIO-L (MONO).

When connecting video game equipment

Connect video game equipment to the VIDEO 3 INPUT jacks at the front of your TV or the VIDEO IN 3 jacks at the rear of your TV.

When connecting a VCR to the Υ (antenna) terminal

Preset the signal output from the VCR to the program position 0.

When connecting video equipment to the VIDEO 3 INPUT jacks or the VIDEO IN 3 jacks

Do not connect video equipment to the VIDEO 3 INPUT jacks at the front and the VIDEO IN 3 jacks at the rear of your TV simultaneously; otherwise the picture will not be displayed properly on the screen.

If both S1 Video and video signals are input simultaneously

The S1 Video input signal is selected. To view a video input signal, disconnect the S1 Video connection.

Note on the video input

When no signal is input, the screen becomes blue.

Connecting audio/video equipment using MON/TV OUT jacks

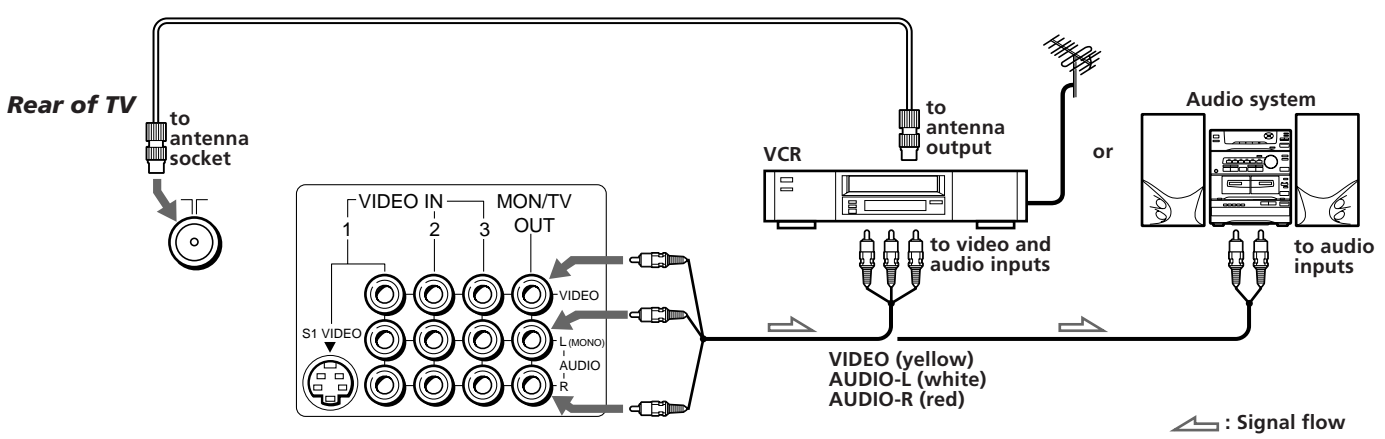

Getting to know the remote commander

Names of buttons on the remote commander are indicated in different colors to represent the available functions.

Label color	Button function
White	For general TV operations.
Green	For Teletext operations.
Yellow	For PIP and PROGRAM INDEX operations.
Blue	For the wide picture mode operations.

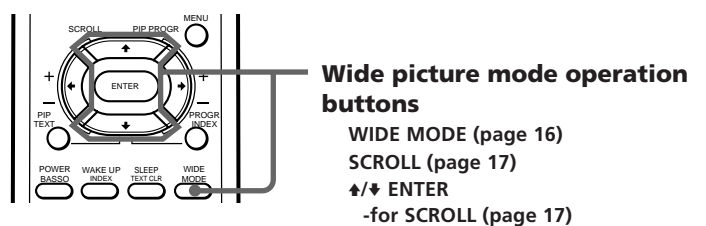
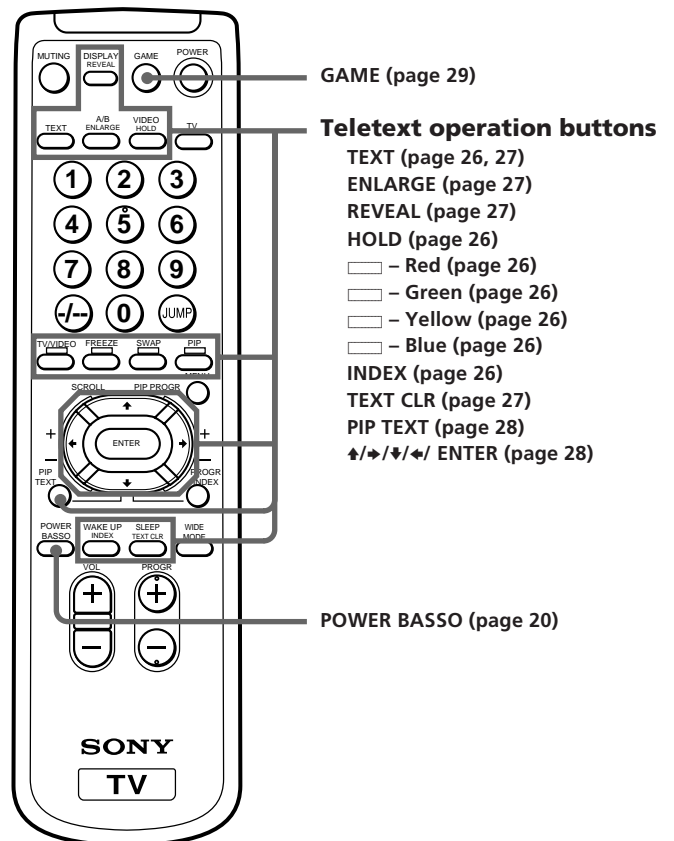
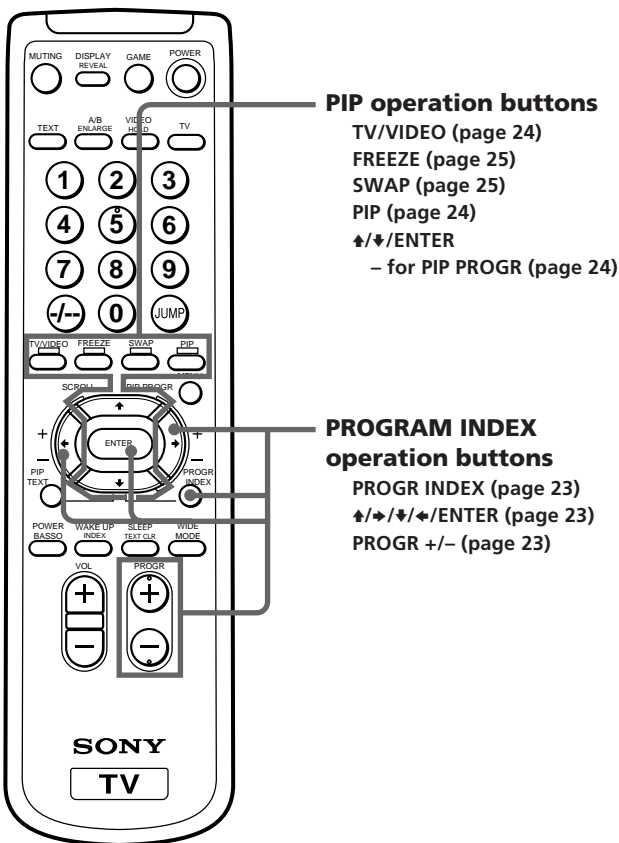

Note

- The Teletext operation buttons are used for KV-V28MN11 only.

Introducing the menus

You can preset TV channels, adjust the picture and sound qualities, and select some settings using the on-screen menus. You can use the buttons on the remote commander or the TV to operate the menus.

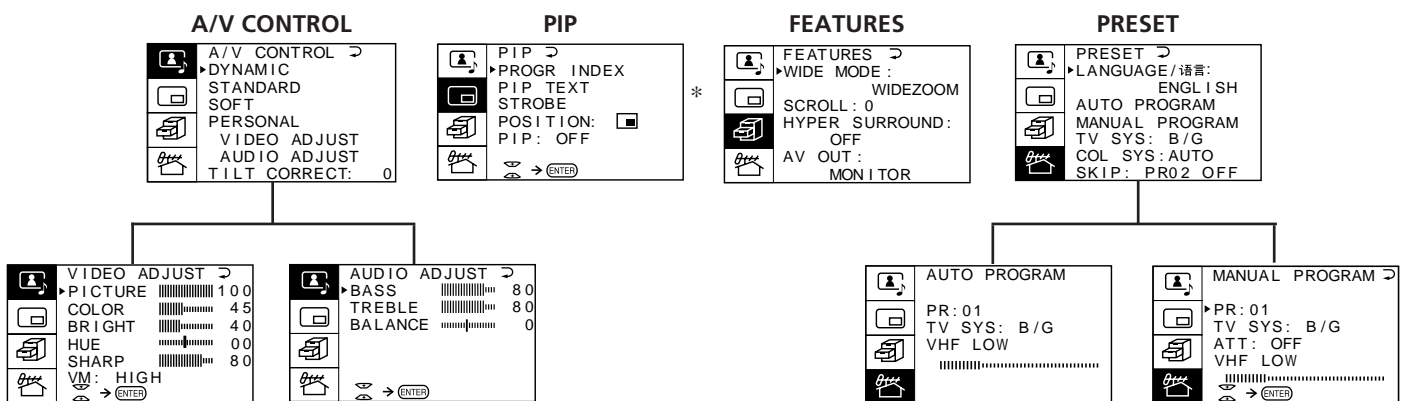

(* KV-V28MN11 only)

Getting back to the previous menu (except for AUTO PROGRAM)

Press **↑** or **↓** to move the cursor (▶) to the first line (↪) of each menu, and press **ENTER**.

Cancelling the menu screen

Press **MENU**.

Notes (except for AUTO PROGRAM)

- When a menu is selected after pressing **ENTER**, the color of both the menu and the menu symbol change and the cursor (▶) appears beside the first item of the menu.
- When an item on the menu is selected after pressing **ENTER**, the color of the item changes.
- You can refer to the guide (⏏ → **ENTER**) at the bottom of the menus (except for the A/V CONTROL, FEATURES, and PRESET menus) for the basic operations of the menu.
- If more than approximately 60 seconds elapse after you press a button, the menu screen disappears automatically.

Changing the menu language

If you prefer Chinese to English, you can change the menu language. You can use buttons on the remote commander or the TV.

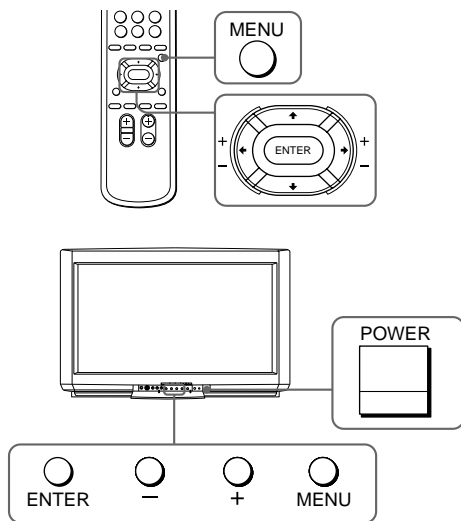

1 Press POWER to turn on the TV.

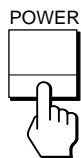

2 Press MENU.



3 Press ↑ or ↓ to move the cursor (▶) to the PRESET menu (PRESET), and press ENTER.

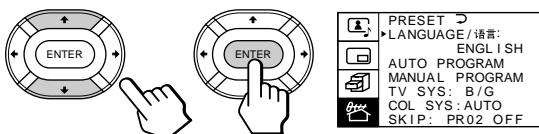

4 Make sure the cursor (▶) appears beside LANGUAGE/ ### and press ENTER.

5 Press ↑/↓/←/→ to select ###, and press ENTER.

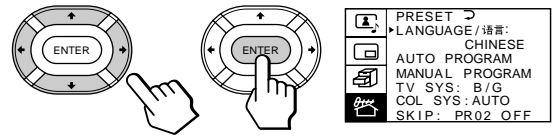

All of the menus change to Chinese.

6 Press MENU to return to the normal screen.



Presetting channels

You can preset TV channels easily by storing all the receivable channels automatically. You can also preset channels manually or disable program positions (see page 12).

Presetting channels automatically

You can preset up to 100 TV channels in numerical sequence from the program position 1. You can preset channels automatically using the button on the TV or the menu.

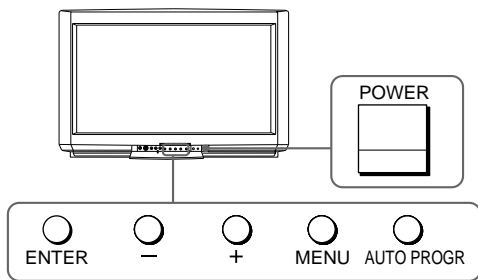

1 Press POWER to turn on the TV.

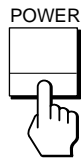

2 Press AUTO PROGR.

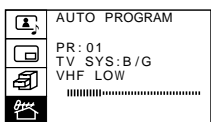

1	2	3
4	5	6
7	8	9

The TV starts scanning and presetting channels automatically. When all of the receivable channels are stored, the AUTO PROGRAM menu disappears and the first nine preset TV programs appear on the nine sub screens. The nine sub screens disappear after being displayed for several seconds.

Note

- If you want to return to the normal screen while the nine sub screens are being displayed, you can press PROGR INDEX on the remote commander.

To preset channels automatically using the menu

- Press MENU.
- Press \uparrow or \downarrow to move the cursor (\blacktriangleright) to the PRESET menu (), and press ENTER.
- Press \uparrow or \downarrow to move the cursor (\blacktriangleright) to AUTO PROGRAM, and press ENTER.

Presetting channels manually

To change the program position for a channel or to receive a channel with a weak signal which you cannot receive by automatic presetting, preset the channel manually.

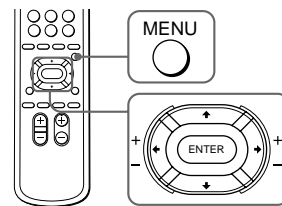

1 Press MENU.

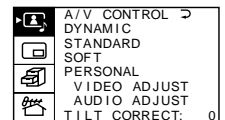

2 Press \uparrow or \downarrow to move the cursor (\blacktriangleright) to the PRESET menu (), and press ENTER.

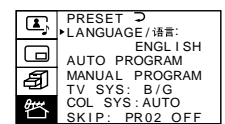
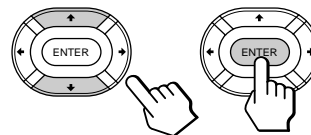

3 Select your local TV system.

- Press \uparrow or \downarrow to move the cursor (\blacktriangleright) to TV SYS, and press ENTER.
- Press $\uparrow/\rightarrow/\downarrow/\leftarrow$ until your local TV system appears on the menu, and press ENTER.

4 Press \uparrow or \downarrow to move the cursor (▶) to MANUAL PROGRAM, and press ENTER.

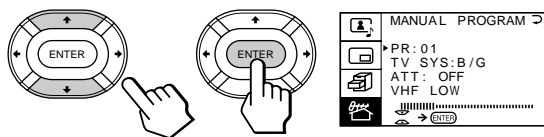

5 Select the program position to which you want to preset a channel.

- (1) Make sure the cursor (▶) appears beside PR, and press ENTER.
- (2) Press \uparrow / \rightarrow / \downarrow / \leftarrow until the program position you want appears on the menu, and press ENTER.

6 Select the desired channel.

- (1) Press \uparrow or \downarrow to move the cursor (▶) to VHF LOW, and press ENTER.
- (2) Press \uparrow / \rightarrow / \downarrow / \leftarrow until the desired channel picture appears on the TV screen, and press ENTER.

7 Press MENU to return to the normal screen.

If the TV signal is too strong

The picture may be distorted. You can reduce the picture distortion as described below.

- 1 Display the PRESET menu.
- 2 Press \uparrow or \downarrow to move the cursor (▶) to MANUAL PROGRAM, and press ENTER.
- 3 Press \uparrow or \downarrow to move the cursor (▶) to ATT, and press ENTER.
- 4 Press \uparrow / \rightarrow / \downarrow / \leftarrow to select ON, and press ENTER.

If the TV system is not properly selected

The picture color may be poor and/or the sound may be noisy. In this case, select the appropriate TV system.

- 1 Press PROGR +/- or the number buttons to select the program position.
- 2 Display the PRESET menu.
- 3 Press \uparrow or \downarrow to move the cursor (▶) to TV SYS, and press ENTER.
- 4 Press \uparrow / \rightarrow / \downarrow / \leftarrow until the appropriate TV system appears, and press ENTER.

Notes

- The TV system and the ATT (attenuator) settings are memorized for each program position.
- If you do not know your local TV system, consult your nearest Sony dealer or authorized service center.

Disabling program positions

By disabling unused or unwanted program positions, you can skip those positions when you press PROGR +/-.

- 1 Press MENU.
- 2 Press \uparrow or \downarrow to move the cursor (▶) to the PRESET menu (), and press ENTER.
- 3 Press \uparrow or \downarrow to move the cursor (▶) to SKIP, and press ENTER.
- 4 Press \uparrow or \downarrow until the unused or unwanted program position appears on the menu, and press ENTER.
- 5 Press \uparrow / \rightarrow / \downarrow / \leftarrow to select ON, and press ENTER.
- 6 To disable other program positions, repeat steps 4 and 5.
- 7 Press MENU to return to the normal screen.

To cancel the skip setting

- 1 Display the PRESET menu.
- 2 Press \uparrow or \downarrow to move the cursor (▶) to SKIP, and press ENTER.
- 3 Press \uparrow or \downarrow until the program position you want to cancel the skip setting appears, and press ENTER.
- 4 Press \uparrow / \rightarrow / \downarrow / \leftarrow to select OFF, and press ENTER.

Watching the TV

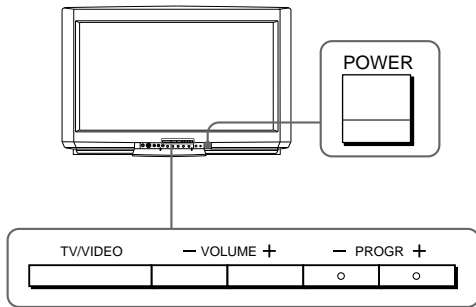

1 Press POWER to turn on the TV.

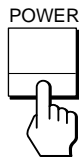

When the TV is turned on in the standby mode after pressing POWER on the TV, press POWER on the remote commander.

2 Select the TV program you want to watch.

To select a program position directly

Press the number button.

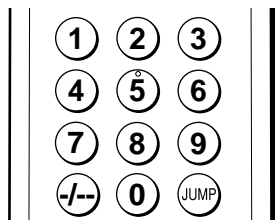

To select a two-digit program position, press “-/-” before the number buttons.

For example: to select program position 25, press “-/-,” then “2” and “5.”



To scan through program positions

Press PROGR +/- on the remote commander or the TV until the program position you want appears.

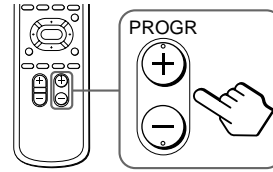

3 Press VOL +/- on the remote commander or VOLUME +/- on the TV to adjust the volume.

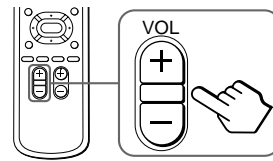

Turning off the TV

To turn off the TV temporarily

Press POWER on the remote commander. The STANDBY indicator lights up.

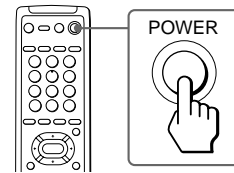

To turn off the TV completely

Press POWER on the TV.

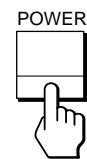

Watching the video input

Press VIDEO/HOLD on the remote commander or TV/VIDEO on the TV.

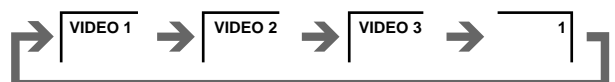
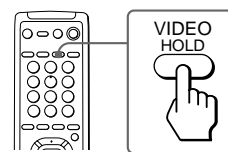

To watch TV

Press TV on the remote commander or TV/VIDEO on the TV.

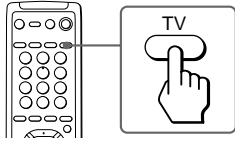

Switching back quickly to the previous channel

Press JUMP.

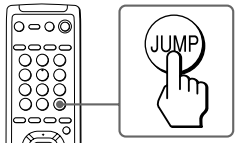

Muting the sound

Press MUTING.

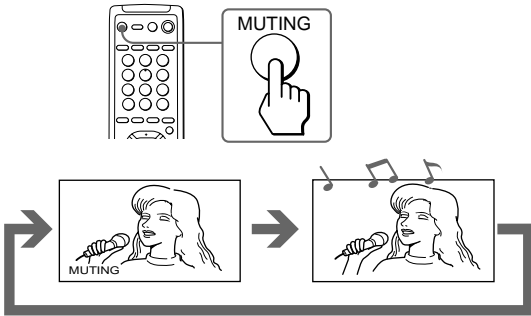

Displaying the on-screen information

Press DISPLAY/REVEAL.

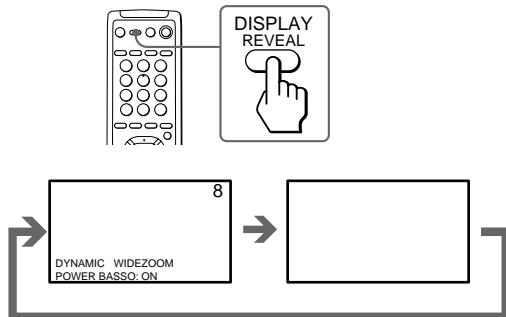

Note

- The on-screen display shows the program position or the video mode, the picture and sound information. The on-screen display for the picture and sound information disappear after being displayed for approximately three seconds.

Setting the Wake Up Timer

You can set the TV to turn on automatically after the period of time you want.

1 Press WAKE UP/INDEX repeatedly to set the timer.

The on-screen display appears.

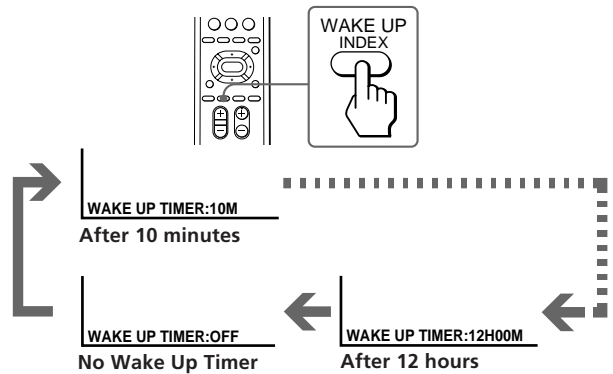

2 If you want a particular TV program or video mode to be displayed using the Wake Up Timer, select the TV program or video mode.

3 Press POWER on the remote commander or set the Sleep Timer to turn off the TV in the standby mode.

The WAKE UP indicator lights up in amber color.

To cancel the Wake Up Timer, press WAKE UP/INDEX repeatedly until "WAKE UP TIMER: OFF" appears, or turn off the main power of the TV.

Notes

- The Wake Up Timer starts immediately after the on-screen display disappears.
- The last TV program position or video mode just before the TV turns into the standby mode will appear when the TV is turned on using the Wake Up Timer.
- If no buttons or controls are pressed for more than two hours after the TV is turned on using the Wake Up Timer, the TV automatically turns into the standby mode. If you want to continue watching the TV, press any button or control on the TV or remote commander.

Setting the Sleep Timer

You can set the TV to turn off automatically after the period of time you want.

Press SLEEP.

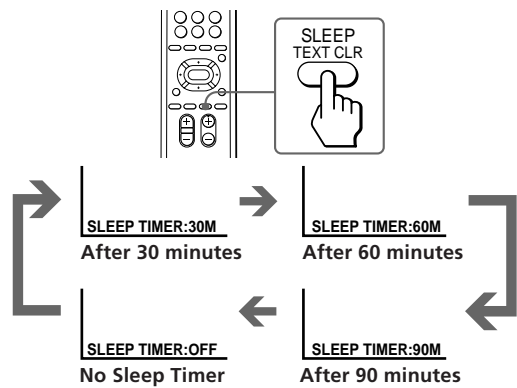

To cancel the Sleep Timer, press SLEEP repeatedly until "SLEEP TIMER: OFF" appears, or turn the TV off.

Watching the picture in wide mode (WIDE MODE)

The WIDE MODE feature allows you to watch a variety of wide mode pictures.

You can select the wide picture modes using the button on the remote commander or the menu.

Press WIDE MODE repeatedly until the wide picture mode you want appears on the screen.

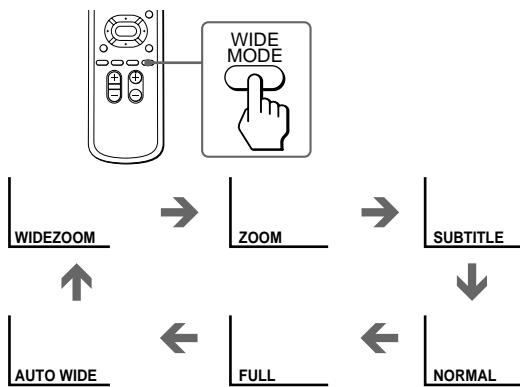

WIDEZOOM

The entire picture is enlarged to fully fit the screen. This mode is ideal for viewing a movie or a sport program.

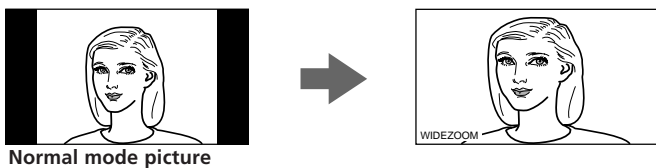

ZOOM

The entire picture is enlarged and the edges are cut off. This mode is ideal for viewing a movie with black bands.

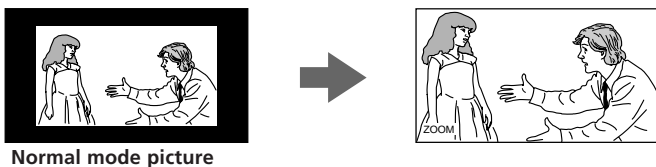

SUBTITLE

The entire picture is enlarged to fully fit the screen, and the height of the subtitle area is reduced. This mode is ideal for viewing a movie with subtitles.

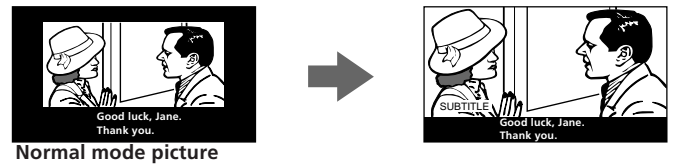

FULL

The width of the picture is increased. This mode is ideal for viewing a video game screen.

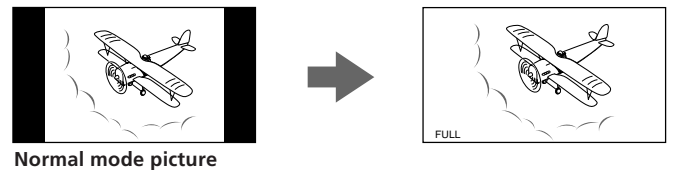

AUTO WIDE

The picture mode of a TV program or a video input changes automatically to the most suitable wide mode (WIDEZOOM, ZOOM, or SUBTITLE).

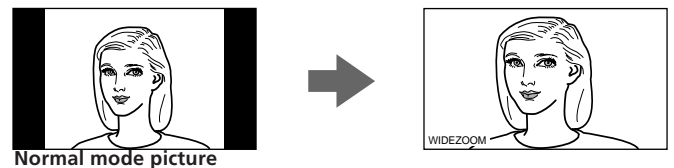

or

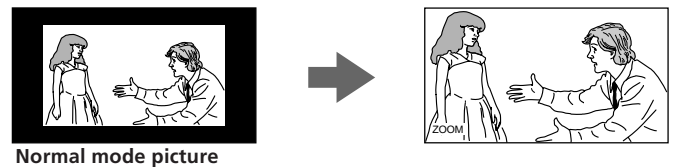

or

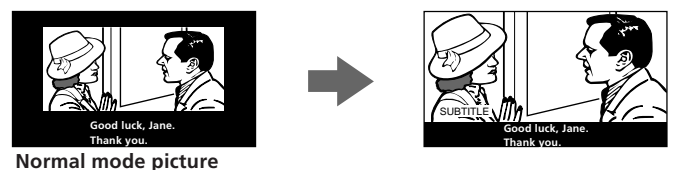

Notes

- If you display the PIP screen in the ZOOM mode, the bottom of the PIP screen may disappear. This does not indicate a malfunction.
- When using the AUTO WIDE function, the selected wide picture mode may not stick to a particular mode. In this case, select the wide mode you want using the WIDE MODE button.
- The AUTO WIDE function is not available for the SECAM color system.

To watch a picture in wide mode using the menu

- 1 Press MENU.

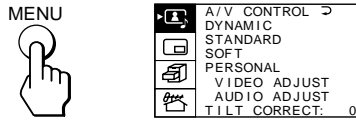

- 2 Press **↑** or **↓** to move the cursor (▶) to the FEATURES menu (📁), and press ENTER.

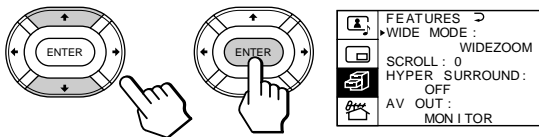

- 3 Make sure the cursor (▶) appears beside WIDE MODE, and press ENTER.

- 4 Press **↑/→/↓/←** to select the wide picture mode you want, and press ENTER.

- 5 Press MENU to return to the normal screen.

Scrolling a picture up or down (SCROLL)

The SCROLL feature allows you to scroll a picture up or down to view the hidden picture at the top or the bottom of the TV screen when watching a wide mode picture.

You can use the scroll feature when displaying the picture in the ZOOM or SUBTITLE mode.

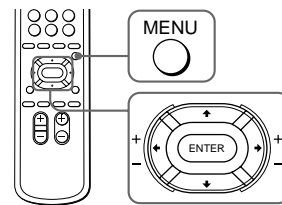

- 1 Press MENU.

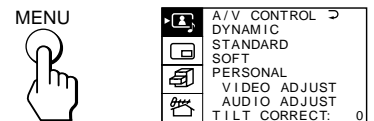

- 2 Press **↑** or **↓** to move the cursor (▶) to the FEATURES menu (📁), and press ENTER.

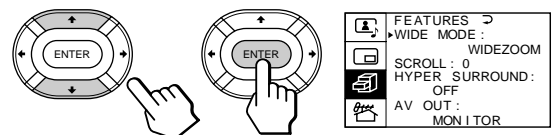

- 3 Press **↑** or **↓** to move the cursor (▶) to SCROLL, and press ENTER.

- 4 Press **↑** or **↓** to select the most suitable scroll position, and press ENTER.

SCROLL:

-5 ← -4 ← -3 ← -2 ← -1 ← 0 → +1 → +2 → +3 → +4 → +5
 Press ↓ Press ↑

Note

- If you scroll the picture with the PIP screen in the ZOOM or SUBTITLE mode, the bottom of the PIP screen may disappear. This does not indicate a malfunction.

Adjusting the picture and sound

Selecting the picture and sound modes

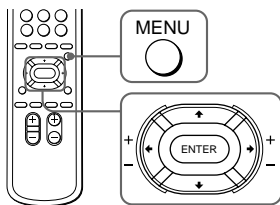

1 Press MENU.

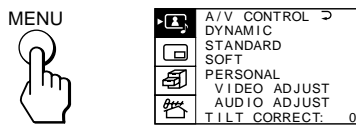

2 Make sure the cursor (▶) appears in the A/V CONTROL menu (⏏), and press ENTER.

3 Press ↑ or ↓ to move the cursor (▶) to DYNAMIC, STANDARD, SOFT, or PERSONAL, and press ENTER.

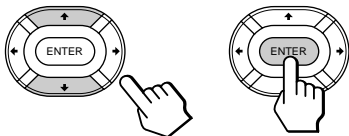

Select	To
DYNAMIC	Receive high contrast picture with powerful sound.
STANDARD	Receive normal contrast picture with medium listening sound.
SOFT	Receive mild picture with soft sound.
PERSONAL	Receive the last picture and sound settings that are adjusted using VIDEO ADJUST and AUDIO ADJUST.

4 Press MENU to return to the normal screen.



Adjusting the picture settings (VIDEO ADJUST)

You can adjust the picture settings to suit your taste with the VIDEO ADJUST option. The adjusted settings are stored in the PERSONAL option.

1 Press MENU.

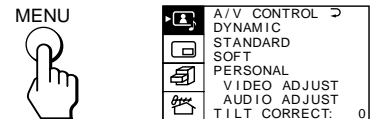

2 Make sure the cursor (▶) appears in the A/V CONTROL menu (⏏), and press ENTER.

3 Press ↑ or ↓ to move the cursor (▶) to VIDEO ADJUST, and press ENTER.

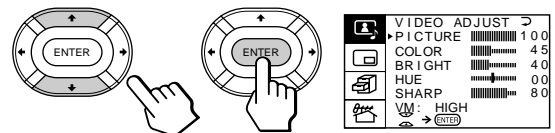

4 Press ↑ or ↓ to move the cursor (▶) to the item you want to adjust, and press ENTER.

5 Press ↑/→/↓/← to adjust the selected item, and press ENTER.

For details on each item, see "Description of adjustable items" below.

6 To adjust other items, repeat steps 4 and 5.

7 Press MENU to return to the normal screen.

Description of adjustable items

Item	Press ↓/←	Press ↑/→
PICTURE	Decrease picture contrast.	Increase picture contrast.
COLOR	Decrease color intensity.	Increase color intensity.
BRIGHT	Darken the picture.	Brighten the picture.
HUE	Make picture tones become reddish.	Make picture tones become greenish.
SHARP	Soften the picture.	Sharpen the picture.
VM	Decrease emphasis on picture edges.	Increase emphasis on picture edges.

Note

- You can adjust HUE for the NTSC system only.

If the picture is slightly snowy

You may try to improve the picture by changing the VM setting as described below:

- 1 Display the VIDEO ADJUST menu.
- 2 Press **▲** or **▼** to move the cursor (▶) to VM, and press ENTER.
- 3 Press **▲/▶/▼/◀** to select LOW, and press ENTER.

If the picture color is abnormal when receiving programs through the ㊦ (antenna) terminal

Change the color system or the TV system from the PRESET menu as described below until the color becomes normal.

- 1 Display the PRESET menu.
- 2 Press **▲** or **▼** to move the cursor (▶) to COL SYS or TV SYS, and press ENTER.
- 3 Press **▲/▶/▼/◀** to change the color system or the TV system until the color becomes normal, and press ENTER.

Note

- Normally set the color system (COL SYS) to AUTO.

Adjusting the sound settings (AUDIO ADJUST)

You can adjust the sound settings to suit your taste with the AUDIO ADJUST option. The adjusted settings are stored in the PERSONAL option.

1 Press MENU.

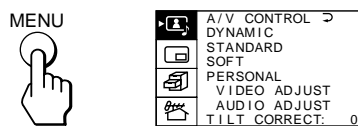

2 Make sure the cursor (▶) appears in the A/V CONTROL menu (A/V), and press ENTER.

3 Press ▲ or ▼ to move the cursor (▶) to AUDIO ADJUST, and press ENTER.

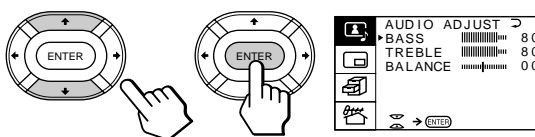

4 Press ▲ or ▼ to move the cursor (▶) to the item you want to adjust, and press ENTER.

5 Press ▲/▶/▼/◀ to adjust the selected item, and press ENTER.

For details on each item, see "Description of adjustable items" below.

6 To adjust other items, repeat steps 4 and 5.

7 Press MENU to return to the normal screen.

Description of adjustable items

Item	Press ▼/◀	Press ▲/▶
BASS	Decrease the bass sound.	Increase the bass sound.
TREBLE	Decrease the treble sound.	Increase the treble sound.
BALANCE	Increase the left speaker's volume	Increase the right speaker's volume.

If the sound is distorted or noisy when receiving programs through the ㊦ (antenna) terminal

Change the TV system from the PRESET menu as described below until the sound becomes normal.

- 1 Display the PRESET menu.
- 2 Press **▲** or **▼** to move the cursor (▶) to TV SYS, and press ENTER.
- 3 Press **▲/▶/▼/◀** to change the TV system until the sound becomes normal, and press ENTER.

Listening to the POWER BASSO sound

The POWER BASSO sound enables you to enjoy a high quality sound mode with the best combination of all types of sound. It reproduces dynamic and clear sounds and emphasizes low and high audio effects as well.

Press POWER BASSO.

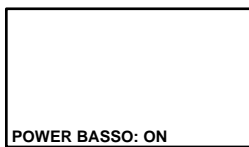
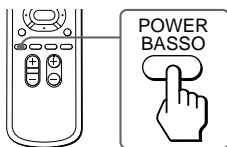

The sound mode of the TV program or the video input changes to the POWER BASSO sound.

To restore the previous sound mode

Press POWER BASSO again.

Note

- You can select any of the surround sound modes (HYPER SURROUND) to cancel the POWER BASSO sound.

Listening to the surround sound (HYPER SURROUND)

The HYPER SURROUND feature enables you to enjoy a surround sound effect that is like being in a concert hall or movie theater when receiving stereo signals.

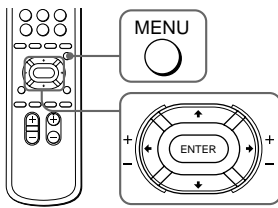

1 Press MENU.

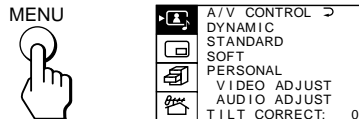

2 Press ↑ or ↓ to move the cursor (▶) to the FEATURES menu (FEATURES), and press ENTER.

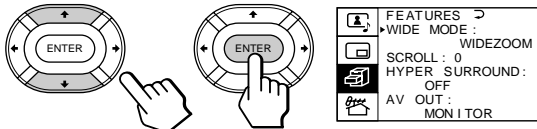

3 Press ↑ or ↓ to move the cursor (▶) to HYPER SURROUND, and press ENTER.

4 Press ↑/→/↓/← to select MOVIE, MUSIC, NEWS(BBE), HALL(SRS), or SPACE, and press ENTER.

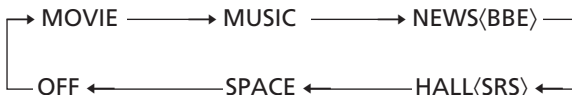

For details on each item, see “Description of adjustable items” below.

5 Press MENU to return to the normal screen.

Description of adjustable items

Select	To
MOVIE	Listen to a sound that emphasizes the bass audio effect of movie theater.
MUSIC	Listen to a dynamic and clear sound that emphasizes the low and high audio effect.
NEWS(BBE)	Listen to a sound that emphasizes voice.
HALL(SRS)	Listen to a sound that spreads out over a large area, giving the feeling of being at a concert hall.
SPACE	Listen to a monaural sound that gives a stereo-like effect.
OFF	Turn off the surround sound.

Notes

- The BBE is manufactured by Sony Corporation under license from BBE Sound, Inc. It is covered by U.S. Patent No. 4,638,258 and No. 4,482,866. The word “BBE” and the BBE symbol are the trademarks of BBE Sound, Inc.
- The (●)® SRS (SOUND RETRIEVAL SYSTEM) is manufactured by Sony Corporation under license from SRS Labs, Inc. It is covered by U.S. Patent No. 4,748,669. The word “SRS” and the SRS symbol (●) are registered trademarks of SRS Labs, Inc.

Selecting a stereo or bilingual program

You can enjoy stereo sound or bilingual programs of NICAM and A2 (German) stereo systems.

Press A/B/ENLARGE repeatedly until you receive the sound you want.

The on-screen display changes corresponding to the selected sound and the STANDBY/STEREO/WAKE UP indicator also lights up.

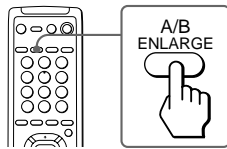

Receiving area for NICAM and A2 (German) programs

System	Receiving area
NICAM	Hong Kong, Singapore, New Zealand, etc.
A2 (German)	Australia, Malaysia, Thailand, etc.

Notes

- If the signal is very weak, the sound becomes monaural automatically.
- If the stereo sound is noisy when receiving a NICAM program, select "MONO." The sound becomes monaural, however, the noise will be reduced.

When receiving a NICAM program

Broadcasting	On-screen display (Selected sound)
NICAM stereo	<pre> NICAM (Stereo sound) → MONO (Regular sound) </pre>
NICAM bilingual	<pre> NICAM MAIN (Main sound) → NICAM SUB (Sub sound) → MONO (Regular sound) </pre>
NICAM monaural	<pre> NICAM MAIN (Main sound) → MONO (Regular sound) </pre>

When receiving an A2 (German) program

Broadcasting	On-screen display (Selected sound)
A2 (German) stereo	STEREO (Stereo sound)
A2 (German) bilingual	<pre> MAIN (Main sound) → SUB (Sub sound) </pre>

Viewing multiple programs at the same time (PROGRAM INDEX)

The PROGRAM INDEX feature allows you to view all the preset TV programs and the video inputs on the nine sub screens within the main screen at the same time.

You can view multiple programs on the nine sub screens using the button on the remote commander or the menu.

Press PROGR INDEX.

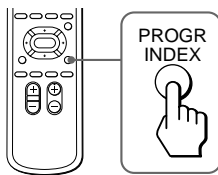

The first nine preset programs appear on the nine sub screens.

>>> 1	2	3
4	5	6
7	8	9

To view the next or the previous nine preset programs on the nine sub screens

Press PROGR +/- on the remote commander or the TV.

>>> 10	11	12
V1	V2	V3
1	2	3

↔

>>> 1	2	3
4	5	6
7	8	9

To select the program you want to watch directly after viewing multiple programs on the nine sub screens

Press the number buttons, VIDEO/HOLD, or press $\uparrow/\rightarrow/\downarrow/\leftarrow$ to move the cursor (>>>) that appears on the first screen to the screen of the program you want to watch, and press ENTER.

To restore the normal screen

Press PROGR INDEX again or PIP.

You can also select PROGR INDEX or PIP : OFF from the PIP menu, and press ENTER to restore the normal screen.

To view multiple programs on the nine sub screens using the menu

1 Press MENU.

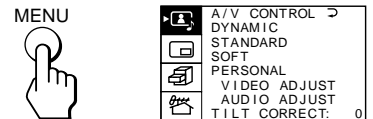

2 Press \uparrow or \downarrow to move the cursor (▶) to the PIP menu (PIP), and press ENTER.

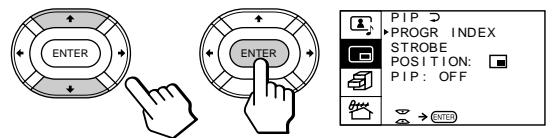

3 Make sure the cursor (▶) appears beside PROGR INDEX, and press ENTER.

Notes

- You can change the position of the nine sub screens using the PIP menu (as described in "Changing the position of the PIP screen" on page 25).
- You can hear the sound of the main screen when viewing multiple programs on the nine sub screens.
- You can use the number buttons on the remote commander to change the program position of the main screen when viewing multiple programs on the nine sub screens.

Displaying frame-by-frame pictures (STROBE)

You can watch a slow motion movement of the main screen picture which is displayed frame-by-frame on the nine sub screens within the main screen.

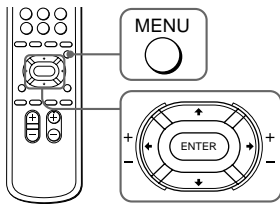

1 Press MENU.



2 Press ↑ or ↓ to move the cursor (▶) to the PIP menu (□), and press ENTER.

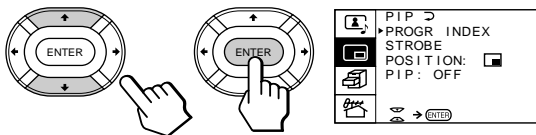

3 Press ↑ or ↓ to move the cursor (▶) to STROBE, and press ENTER.

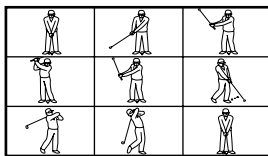

To restore the normal screen

Select STROBE again or PIP : OFF from the PIP menu, and press ENTER.

You can also press TV, VIDEO/HOLD, PROGR +/-, or PIP to restore the normal screen.

Notes

- You can change the position of the nine sub screens using the PIP menu (as described in "Changing the position of the PIP screen" on page 25).
- You can hear the normal sound when using the STROBE feature.

Using the Picture-in-Picture (PIP) features

With the Picture-in-Picture (PIP) feature, you can display a sub screen within the main picture of different TV programs or video inputs.

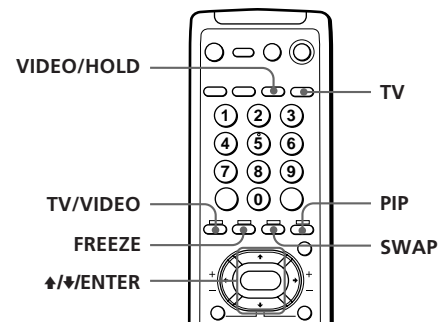

Displaying the PIP screen

You can display the PIP screen using the button on the remote commander or the menu.

Press PIP.

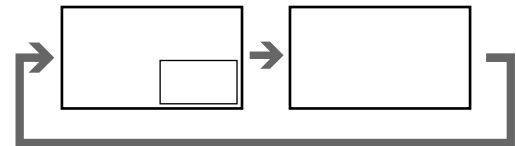

Selecting a TV program or video input in the PIP screen

To select a TV program, press ↑ or ↓, and press ENTER.

To select a video input, press TV/VIDEO.

To display the PIP screen using the menu

1 Press MENU.

2 Press ↑ or ↓ to move the cursor (▶) to the PIP menu (□), and press ENTER.

3 Press ↑ or ↓ to move the cursor (▶) to PIP, and press ENTER.

4 Press +/- to select ON, and press ENTER.

5 Press MENU to return to the normal screen.

Changing the position of the PIP screen

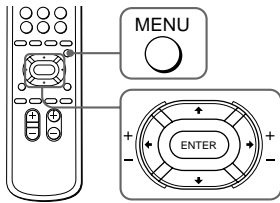

1 Press MENU.

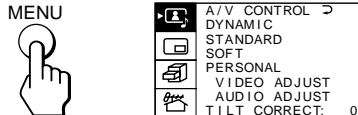

2 Press **↑** or **↓** to move the cursor (▶) to the PIP menu (📺), and press ENTER.

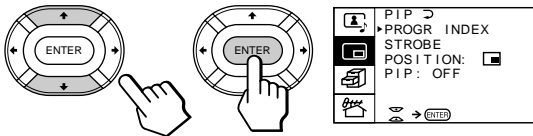

3 Press **↑** or **↓** to move the cursor (▶) to POSITION, and press ENTER.

4 Press **↔**/**↕**/**↔**/**↕** to select the position you want, and press ENTER.

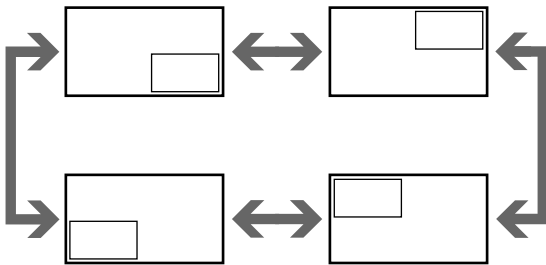

5 Press MENU to return to the normal screen.

Swapping pictures between the main and PIP screens

Press SWAP.

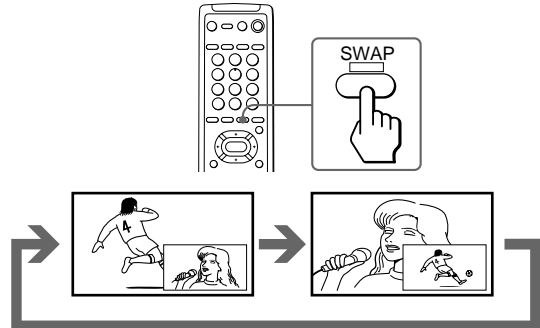

Freezing the PIP screen

Press FREEZE.

The PIP screen will freeze.

To restore the normal screen

Press FREEZE again.

Notes

- When you display a video input on the PIP screen at an abnormal speed, the picture may be noisy depending on the VCR.
- If you display different color systems on the main screen and the PIP screen, the size of the PIP screen may be different and the PIP picture may be noisy. This does not indicate a malfunction of the TV.

Viewing Teletext

■ KV-V28MN11 only

TV stations broadcast an information service called Teletext via a TV channel. Teletext service allows you to receive various information such as weather forecasts or news at any time.

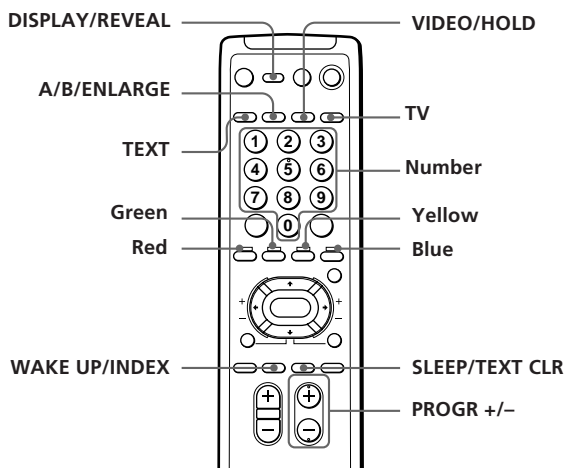

Displaying Teletext

1 Select a TV channel that carries the Teletext broadcast you want to watch.

2 Press TEXT to display the Teletext.

A Teletext page (normally the index page) is displayed. If there is no Teletext broadcast, "100" is displayed at the top left corner of the screen.

To turn off Teletext

Press TV.

Superimposing a Teletext page on the TV picture

Press TEXT.

Each time you press TEXT, the screen changes as follows:



Checking the contents of a Teletext service (INDEX)

Press WAKE UP/INDEX to display an overview of the Teletext contents and page numbers.

Using FASTEXT

This feature allows you to quickly access a Teletext page that uses FASTEXT. When a FASTEXT page is broadcasted, the colored-menus appear at the bottom of the screen. The colors of the menus correspond to the red (TV/VIDEO), green (FREEZE), yellow (SWAP), and blue (PIP) color-coded buttons on the remote commander.

To access a FASTEXT menu

Press the color-coded button on the remote commander that corresponds to the colored menu which appears at the bottom of the screen. The menu page appears on the screen after several seconds.

Selecting a Teletext page

Press the number buttons to enter the three-digit page number of the Teletext page you want.

If you make a mistake, re-enter the correct page number.

To access the next or previous page

Press PROGR +/-.

You can also access a Teletext page of any page numbers that appear in the colored column at the bottom of the screen using the corresponding color-coded button on the remote commander.

Holding a Teletext page (HOLD)

A Teletext page may consist of several subpages. You can stop the page scrolling in order to read the text at your own pace.

Press VIDEO/HOLD.

The HOLD symbol "⏸" appears at the top left corner of the screen.

To resume normal Teletext operation

Press VIDEO/HOLD again or TEXT.

Revealing concealed information (REVEAL)

The REVEAL option lets you disclose concealed information, such as an answer to a quiz that you find on some of the Teletext pages.

Press DISPLAY/REVEAL.

To conceal the information

Press DISPLAY/REVEAL again.

Enlarging the Teletext display (ENLARGE)

Press A/B/ENLARGE.

Each time you press A/B/ENLARGE, the Teletext display changes as follows:

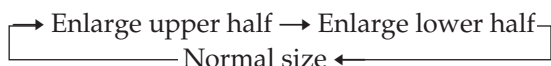

Waiting for a Teletext page while watching a TV program (TEXT CLEAR)

- 1 Key in the page number of the Teletext that you want to refer, then press SLEEP/TEXT CLR.**
- 2 When the page number is displayed on the screen, press TEXT to turn on the Teletext.**

Displaying Teletext on the PIP screen (PIP TEXT)

■ KV-V28MN11 only

The PIP TEXT feature enables you to display a Teletext page on the PIP screen while watching a TV program.

You can display the Teletext on the PIP screen using the button on the remote commander or the menu.

1 Select a TV channel that carries the Teletext broadcast you want to watch.

2 Press PIP TEXT.

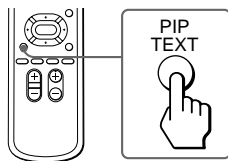

To restore the normal screen

Press PIP TEXT again, TV, VIDEO/HOLD, or PROGR +/-.

You can also select PIP : OFF from the PIP menu, and press ENTER to restore the normal screen.

To display a Teletext page on the PIP screen using the menu

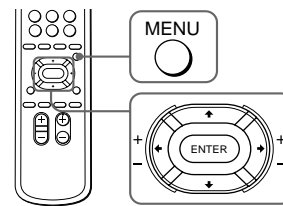

1 Press MENU.



2 Press ↑ or ↓ to move the cursor (▶) to the PIP menu (☐), and press ENTER.

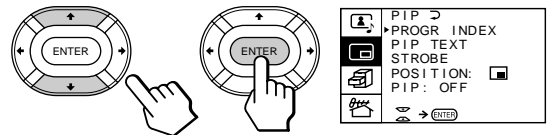

3 Press ↑ or ↓ to move the cursor (▶) to PIP TEXT, and press ENTER.

4 Press ↑/→/↓/← to select the Teletext page you want to watch.

Notes

- You can also use the color-coded buttons (see page 26) while displaying a Teletext page on the PIP screen.
- To select a Teletext page on the PIP screen, press ↑/→/↓/← once only. If you press ↑/→/↓/← continuously, the Teletext page numbers also change continuously at a fast speed.
- You can change the position of a Teletext page on the PIP screen using the PIP menu (as described in "Changing the position of the PIP screen" on page 25).

Viewing a video game screen

You can view a video game screen in the optimum mode that gives soft picture and dynamic sound effect.

Press GAME.

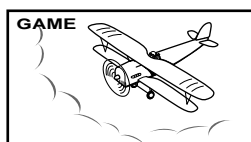
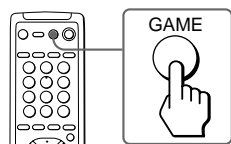

The picture and sound change to the mode that is suitable for a video game.

To restore the normal picture and sound modes

Press TV, VIDEO/HOLD, or PROGR +/-.

Notes

- If you press the GAME button when the TV is in the standby mode, the TV turns on automatically and the picture and sound change to the mode that is suitable for a video game.
- To display a video game screen, connect the video game equipment to the VIDEO 3 INPUT jacks at the front of the TV or the VIDEO IN 3 jacks at the rear of the TV.

Customizing the TV

Using the AV OUT (advanced rec-out) terminal

You can select the output signal from the MON/TV OUT jacks at the rear of the TV. However, the signals of the PROGRAM INDEX, STROBE, PIP modes, and the Teletext broadcast (for KV-V28MN11 only) cannot be output even though MONITOR is selected.

1 Press MENU.

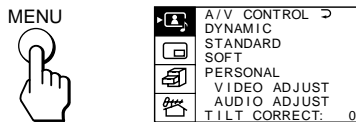

2 Press ↑ or ↓ to move the cursor (▶) to the FEATURES menu (FEATURES), and press ENTER.

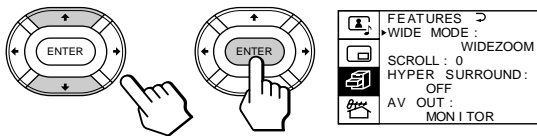

3 Press ↑ or ↓ to move the cursor (▶) to AV OUT, and press ENTER.

4 Press ↑/↓/←/→ to select the output signal, and press ENTER.

Select	To
TV	Output the signal of the TV broadcast.
MONITOR	Output the signal of the picture you are watching as a main picture.

Note

- Do not change the channel while recording with a VCR through the MON/TV OUT jacks. If you change the channel, it also changes the channel you are recording.

Adjusting the picture tilt

You can adjust the picture tilt if it is not aligned to the TV screen. This may happen due to the direction of the earth's magnetic fields in relation to the TV position.

1 Press MENU.

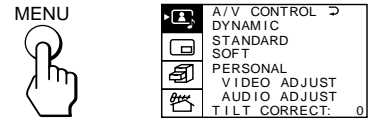

2 Make sure the cursor (▶) appears in the A/V CONTROL menu (A/V CONTROL), and press ENTER.

3 Press ↑ or ↓ to move the cursor (▶) to TILT CORRECT, and press ENTER.

4 Press ↑/↓/←/→ to select the most suitable value to adjust the picture tilt, and press ENTER.

TILT CORRECT:

-5 ← -4 ← -3 ← -2 ← -1 ← 0 → +1 → +2 → +3 → +4 → +5
 Press ↓/← Press ↑/→

Troubleshooting

If you have any problems, read this manual again and check the countermeasure for each of the symptoms listed below.

If the problem persists, contact your nearest Sony dealer or authorized service center.

Snowy picture Noisy sound

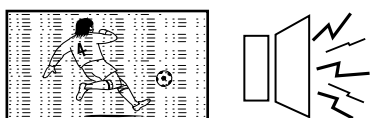

- Check the antenna.
- Check the antenna connection on the TV and on the wall.
- Check the TV system (TV SYS) setting.
- Check the ATT (attenuator) setting.

Dotted lines or stripes

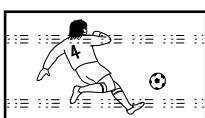

- This may be caused by local interference (e.g. cars, neon signs, hair dryers, etc.). Adjust the antenna for minimum interference.

Double images or "ghosts"



- This may be caused by reflections from nearby mountains or buildings. A highly directional antenna may improve the picture.

Good picture Noisy sound



- Check the TV system (TV SYS) setting.

No picture No sound

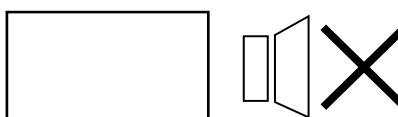

- Press POWER.
- Press POWER to turn off the TV for about five seconds and then turn it on again.
- Check the power cord connection.
- Check the antenna connection.
- Check the VCR connections.

Good picture No sound

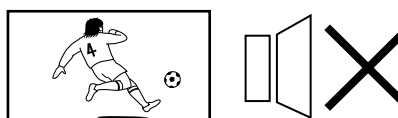

- Press VOL +.
- Press MUTING.
- Press A/B/ENLARGE.

No color



- Adjust the COLOR level in the VIDEO ADJUST menu of the PERSONAL option.
- Check the color system (COL SYS) setting.

TV cabinet creaks

- Even if the picture or the sound is normal, changes in the room temperature sometimes make the TV cabinet expand or contract, making a noise. This does not indicate a malfunction.

Specifications

	KV-V28MH1, KV-V28MN11	Note
Power requirements	110-240 V AC, 50/60 Hz	
Power consumption (W)	Indicated on the rear of TV	
Television system	B/G, I, D/K, M	
Color system	PAL, PAL 60, SECAM, NTSC4.43, NTSC3.58	
Stereo system	NICAM Stereo B/G, I ; A2 Stereo (German) B/G	
Teletext language	English, German, Swedish, Italian, French, Spanish	KV-V28MN11
Channel coverage		
B/G	VHF : E2 to E12 / UHF : E21 to E69 / CATV : S01 to S03, S1 to S41	
I	UHF : B21 to B68 / CATV : S01 to S03, S1 to S41	
D/K	VHF : C1 to C12, R1 to R12 / UHF : C13 to C57, R21 to R60 / CATV: Z1 to Z39, S01 to S03, S1 to S41	
M	VHF : A2 to A13 / UHF : A14 to A79/ CATV: A-8 to A-2, A to W+4, W+6 to W+84	
Antenna	75-ohm external terminal	
Audio output (speaker)	15W + 15W	
Number of Terminal		
Video	Input: 4 Output: 1	Phono jacks; 1 Vp-p, 75 ohms
Audio	Input: 4 Output: 1	Phono jacks; 500 mVrms
S1 Video	Input: 2	Y: 1 Vp-p, 75 ohms, unbalanced, sync negative C: 0.286 Vp-p, 75 ohms
Headphone	Output: 1	Mini jack
Picture tube	28 in. (Wide Trinitron Plus)	
Tube size (cm)	71	Measured diagonally
Screen size (cm)	66	Measured diagonally
Dimensions (w/h/d, mm)	768 × 511 × 518	
Mass (kg)	44.5	
Accessory (optional)	TV stand (SU-V28G)	

Design and specifications are subject to change without notice.