

# *Trinitron Color TV*

---

## Operating Instructions \_\_\_\_\_

**GB**

- Before operating the unit, please read this manual thoroughly and retain it for future reference.

# WEGA

*KV-AW212*









# A Specifications

	KV-AW212M83	KV-AW212M80	Note
<b>Power requirements</b>	110-240 V AC, 50/60 Hz		
<b>Power consumption (W)</b>	Indicated on the rear of the TV		
<b>Television system</b>	B/G, I, D/K		
<b>Color system</b>	PAL, PAL 60, SECAM, NTSC3.58 (AV IN), NTSC4.43		
<b>Channel coverage</b>			
<b>B/G</b>	VHF : E2 to E12 / UHF : E21 to E69 / CATV : S01 to S03, S1 to S41		
<b>I</b>	UHF : B21 to B68 / CATV : S01 to S03, S1 to S41		
<b>D/K</b>	VHF : C1 to C12, R1 to R12 / UHF : C13 to C57, R21 to R60 / CATV : S01 to S03, S1 to S41, Z1 to Z39		
<b>⌚ (Antenna)</b>	75-ohm external terminal		
<b>Audio output (Speaker)</b>	3 W + 3 W		
<b>3D Woofer</b>	12 W	—	
<b>Number of terminal</b>			
<b>Ⓜ (Video)</b>	Input: 2	Output: 1	Phono jacks; 1 V <sub>p-p</sub> , 75 ohms
<b>🎵 (Audio)</b>	Input: 2	Output: 1	Phono jacks; 500 mVrms
<b>Picture tube</b>	21 in.		
<b>Tube size (cm)</b>	54		Measured diagonally
<b>Screen size (cm)</b>	51		Measured diagonally
<b>Dimensions (w/h/d, mm)</b>	600 × 584 × 481	600 × 465 × 481	
<b>Mass (kg)</b>	28	25	

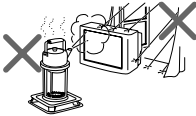
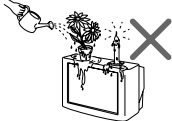
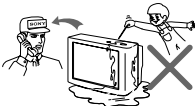
Design and specifications are subject to change without notice.

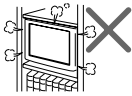
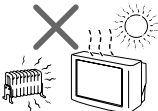
# **B** WARNING

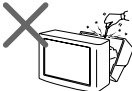
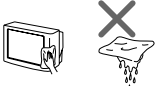
- Dangerously high voltages are present inside the TV.
- TV operating voltage: 110 – 240 V AC.
- Do not plug in the power cord until you have completed making all other connections; otherwise a minimum leakage current might flow through the antenna and other terminals to ground.
- To avoid battery leakage and damage to the remote, remove the batteries from the remote if you are not going to use it for several days. If any liquid leaks from the batteries and touches your skin, immediately wash it away with water.

 <p>For your own safety, do not touch any part of the TV, the power cord and the antenna cable during lightning storms.</p>	 <p>For children's safety, do not leave children alone with the TV. Do not allow children to climb onto it.</p>	 <p>To prevent fire or shock hazard, do not expose the TV to rain or moisture.</p>
 <p>Do not place any objects on the TV. The apparatus shall not be exposed to dripping or splashing and that no objects filled with liquids, such as vases, shall be placed on the apparatus.</p>	 <p>Do not operate the TV if any liquid or solid object falls into it. Have it checked immediately by qualified personnel only.</p>	 <p>Install the TV on a stable TV stand and floor which can support the TV set weight. Ensure that the TV stand surface is flat and its area is larger than the bottom area of the TV.</p>
 <p>Do not block the ventilation openings of the TV. Do not install the TV in a confined space, such as a bookcase or built-in cabinet.</p>	 <p>Your TV is recommended for home use only. Do not use the TV in any vehicle or where it may be subject to excessive dust, heat, moisture or vibrations.</p>	 <p>Do not plug in too many appliances to the same power socket. Do not damage the power cord.</p>
 <p>Do not open the cabinet and the rear cover of the TV as high voltages and other hazards are present inside the TV. Refer servicing and disposal of the TV to qualified personnel.</p>	 <p>Clean the TV with a dry and soft cloth. Do not use benzine, thinner, or any other chemicals to clean the TV. Do not attach anything (e.g., adhesive tape, cellophane tape, glue) on the painted cabinet of the TV. Do not scratch the picture tube.</p>	 <p>Pull the power cord out by the plug. Do not pull the power cord itself. Even if your TV is turned off, it is still connected to the AC power source (mains) as long as the power cord is plugged in. Unplug the TV before moving it or if you are not going to use it for several days.</p>

# C Getting Started

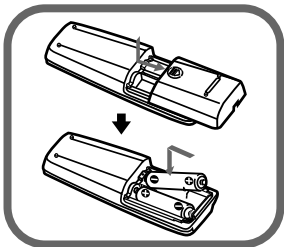

## Step 1

Insert the batteries (supplied) into the remote.

-  • Do not use old or different types of batteries together.

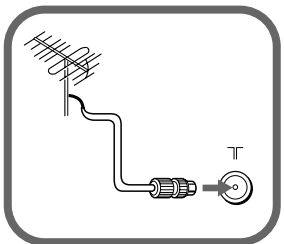

## Step 2

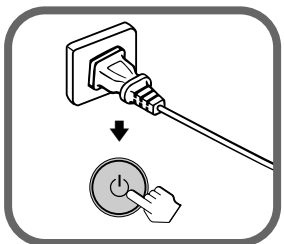

Connect the antenna cable (not supplied) to  (antenna input) at the rear of the TV.

-  • You can also connect your TV to other optional components (see **F**).



## Step 3

Plug in the power cord, then press  on the TV to turn it on.

-  • The  (standby) indicator flashes green for a few seconds when turning on the TV. This does not indicate a malfunction.



## Step 4

Set up the TV by following the instructions of the "Initial Setup" menu (see **D**).

# D Setting up your TV (“Initial Setup”)

When you turn on your TV for the first time, the “Initial Setup” menu will appear. You can adjust settings below using the buttons on the remote control or TV front panel. Press **↑**, **↓**, **←** or **→** to select or adjust items, then press **⏏**.

- 1 Select the desired menu language.

Initial Setup		
Language:	English	
	عربي	
Select <b>⏏</b>	Confirm <b>⏏</b>	End <b>⏏</b>

- 2 Select “Yes” to preset the channels automatically.  
To skip automatic channel presetting, select “No”.

Initial Setup		
First please connect cable/antenna		
Start Auto Program now?		
	Yes	
	No	
Select <b>⏏</b>	Confirm <b>⏏</b>	End <b>⏏</b>

- 3 The “Program Sorting/Edit” menu enables you to sort and edit the channels (see **L**).

Program Sorting/Edit			
PROG	Label	Skip	⏏
001	-----	Off	⏏
002	-----	Off	⏏
003	-----	Off	⏏
004	-----	Off	⏏
Sorting: <b>⏏</b>		Edit: <b>⏏</b>	
Select <b>⏏</b>	Confirm <b>⏏</b>	Exit <b>⏏</b>	

- 4 To prevent this “Initial Setup” menu from appearing again when you turn on the TV by pressing **⏏**, select “No”.

To allow this menu to appear again, select “Yes”.

Initial Setup	
Display this menu next time?	
	Yes
	No
Select <b>⏏</b>	Confirm <b>⏏</b>

- ⚠**: • You can immediately go to the end of the “Initial Setup” menu by pressing WEGA GATE.

# **E** 3D WOOFER

▶ KV-AW212M83 only

You can enjoy high quality sound by connecting the 3D WOOFER as follows:

## Step 1

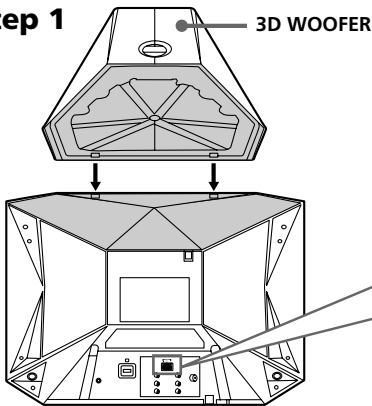

## Step 2

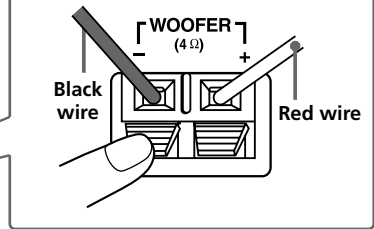

- :
- Connect only the supplied 3D WOOFER; otherwise your TV may malfunction.
  - Unplug your TV from the wall outlet when connecting the 3D WOOFER.
  - To prevent a malfunction caused by a short circuit of the terminals, make sure that none of the 3D WOOFER wire strands stick out, making contact with the neighbouring 3D WOOFER terminal.

# F Connecting optional components

You can connect a wide range of optional components to your TV. Connecting cables are not supplied.

## Connecting to the TV (front)

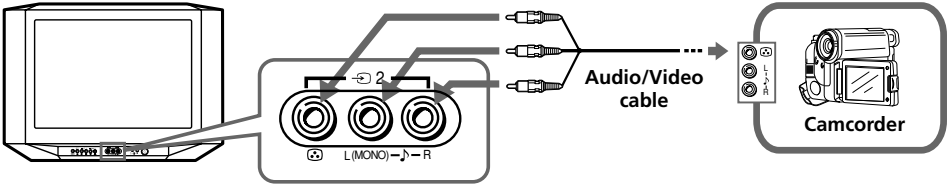

## Connecting to the TV (rear)

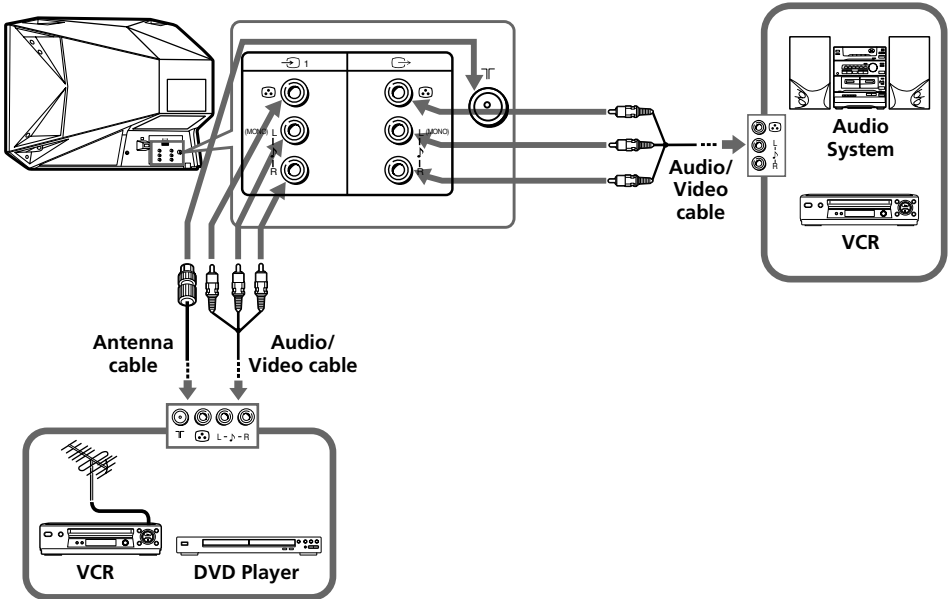

• If you connect a VCR to T (antenna input), preset the signal output from the VCR to the program number 0 on the TV (see **L**).

# **G** Troubleshooting

If you find any problem while viewing your TV, you can either use the “Factory Settings” function (see **M**) or check the Troubleshooting guide below. If the problem persists, contact your Sony dealer.

## **Snowy picture, noisy sound**

- Check the antenna setup and other connections.
- Preset the channel manually again (see **L**).
- Set the “Signal Booster” to “Auto” (see **L**) or try using an external booster.

## **Distorted picture, noisy sound**

- Set the “Signal Booster” to “Off” (see **L**), or turn off or disconnect any external booster in use.

## **Good picture, noisy sound**

- Select the appropriate “TV System” (see **L**).

## **No picture, no sound**

- Check the power cord, antenna setup and other connections.
- Press **I**/**⏻** (power) to turn on the TV.
- Press **⏻** (main power) on the TV to turn off the TV for about five seconds, then turn it on again.

## **Good picture, no sound**

- Press **⏻** + to increase the volume level or press **⏻** to cancel the muting.

## **Dotted lines or stripes**

- Do not use a hair dryer or other equipment near the TV.
- Check the antenna setup.

## **Double images or “ghosts”**

- Use the fine tuning (“Fine”) function (see **L**).
- Check the antenna setup or use a highly directional antenna.
- Turn off or disconnect any external booster in use.

## **No color**

- Adjust the “Color” level from “Picture Adjustment” (see **J**).
- Select the appropriate “Color System” (see **M**).
- Check the antenna setup.

## **Picture slant**

- Keep external speakers or other electrical equipment away from the TV.

## **Abnormal color patches**

- Keep external speakers or other equipment away from the TV. Do not move the TV while the TV is turned on. Press **⏻** (main power) on the TV to turn off the TV for about 15 minutes, then turn it on again to demagnetize the TV.

## **The **⏻** (standby) indicator on your TV flashes red several times after every three seconds.**

- Count the number of times the **⏻** (standby) indicator flashes. Press **⏻** on the TV to turn it off, disconnect the AC power cord and inform your dealer or Sony service center of how the indicator flashes (duration and interval).

## **The TV screen sometimes goes blank for slightly longer than usual during channel change.**

- The “Signal Booster” is functioning to detect a weak signal. This does not indicate a malfunction.

## **TV cabinet creaks.**

- Changes in room temperature sometimes make the TV cabinet expand or contract, causing a noise. This does not indicate a malfunction.

## **A small “boom” sound is heard when the TV is turned on.**

- The TV’s demagnetizing function is working. This does not indicate a malfunction.



# H TV buttons and remote control

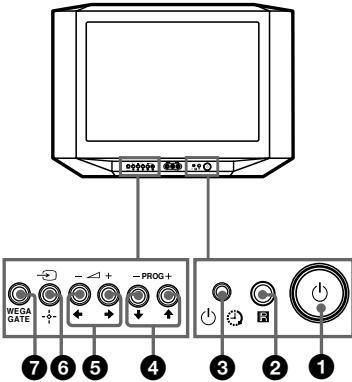

- 1 Turn off or turn on the TV.
- 2 Remote control sensor.
- 3 Wake Up indicator.
- 3 Standby indicator.
- 4 PROG +/- Select program number.
- 5 +/- Adjust volume.
- 6 Select TV or video input.

## WEGA GATE menu operations (see I)

- 4, 5 Select or adjust items.
- 6 Confirm selected items.
- 7 WEGA GATE Display or cancel WEGA GATE menu.

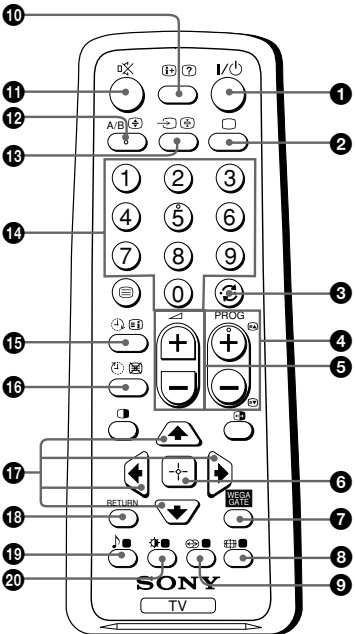

- 1 Turn off temporarily or turn on the TV.
- 2 Display the TV program.
- 3 Jump to last program number that has been watched for at least five seconds.
- 4 Select program number. To select quickly, press and hold until the desired program number appears.
- 5 Adjust volume.
- 8 Not function for your TV.
- 9 Select surround mode options (see K).
- 10 Display on-screen information.
- 11 Mute the sound.
- 12 Not function for your TV.
- 13 Select TV or video input.
- 14 Input numbers. For program numbers 10 and above, enter the next digit within two seconds.

## TV buttons and remote control (continued)

- 19   
(KV-AW212M83  
only)

Select sound mode options with a 5-Band Graphic Equalizer display: “Dynamic”, “Standard”, “Custom”\* (see **K**).







\* When the “Custom” mode is selected, you can receive the last adjusted sound settings from the “Sound Adjustment” option in the menu.

- 20 



Select picture mode options: “Vivid”, “Standard”, “Custom”\* (see **J**).

\* When the “Custom” mode is selected, you can receive the last adjusted picture settings from the “Picture Adjustment” option in the menu.









### WEGA GATE menu operations (see **I**)

- 6  Confirm selected items.  
 7 WEGA GATE  Display or cancel WEGA GATE menu.  
 17  Select or adjust items.  
 18 RETURN  Return to the previous level.

### Timer operations

- 15  (Wake Up Timer) Set TV to turn on automatically according to the desired period of time (max. of 12 hours). The  indicator on TV lights up amber once you set the wake up timer. If no buttons or controls are pressed for more than three hours after the TV is turned on using the wake up timer, the TV automatically goes into standby mode.  
 16  (Sleep Timer) Set TV to turn off automatically according to the desired period of time (max. of one hour and 30 min.).

### Teletext operations (green icon)

- , , , ,  
, , , ,  
 (red, green, yellow, blue)
- Not function for your TV.

### PIP operations

- , ,  Not function for your TV.

# WEGA GATE navigator

WEGA GATE is a gateway that allows you access to preset TV channels, connected external inputs and “Settings” menu.

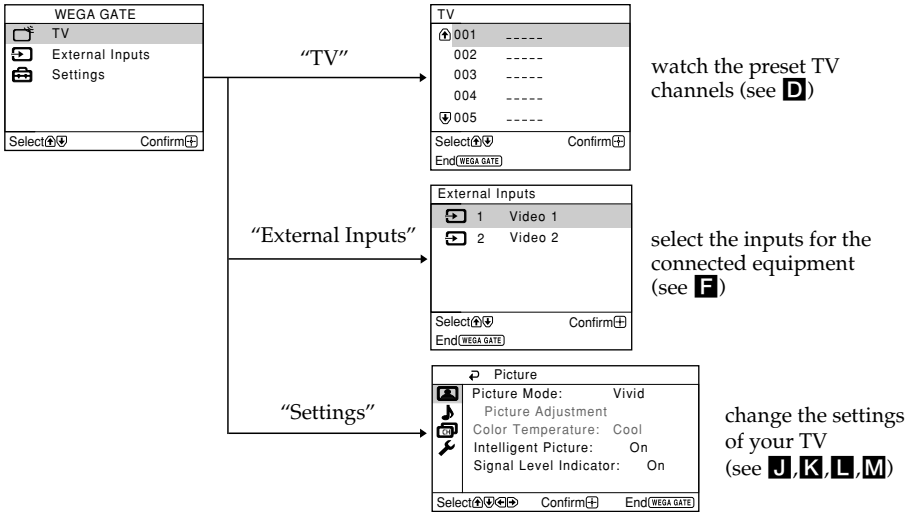

## How to use WEGA GATE

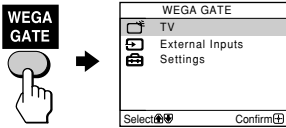

(1) Press WEGA GATE to display or cancel the WEGA GATE menu.

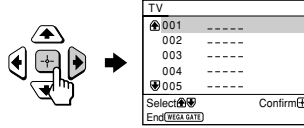

(2) Press **→** (or **↔**) to confirm your selection or go to the next level.

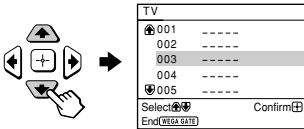

(3) Press **↑** or **↓** to select the desired item.

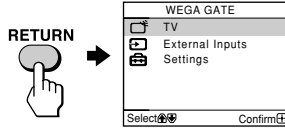



(4) Press RETURN to move to the previous level.

- When a feature is dimmed in the menu, it is not selectable.
- The WEGA GATE, **↔** and **↑, ↓, ↕, ↔** buttons on the front panel can also be used for the operations above.

# J "Picture" setting

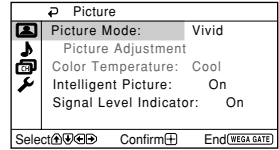
Press WEGA GATE and select "Settings".  
Make sure the "Picture" icon (🖥️) is selected, then press [↵].



"Picture Mode"	Choose either "Vivid" (bright, contrast and sharp), "Standard" (normal) or "Custom"*.
"Color Temperature"	Adjust white color tint. Choose either "Cool" (blue tint), "Neutral" (neutral tint) or "Warm" (red tint).
"Intelligent Picture"	Optimize picture quality. Press ↑ or ↓ to select "On", then press [↵]. To cancel, select "Off", then press [↵].
"Signal Level Indicator"	Display the signal level when the "Intelligent Picture" is functioning. "Intelligent Picture Signal Level" indicator will be displayed, followed by picture improvement when you change the program number or the input mode.  red (weak)    amber (average)    green (fair ..... good) Press ↑ or ↓ to select "On", then press [↵]. To cancel, select "Off", then press [↵]. "Intelligent Picture" is still functioning.

\* You can adjust the setting to your personal preference in the "Picture Adjustment" and "Color Temperature" options only when the "Custom" mode is selected.

## Adjusting the "Picture Adjustment" items under "Custom" mode

- 1 Press ↑ or ↓ to select either "Picture" (contrast), "Brightness", "Color", "Hue" (color tones) or "Sharpness", then press [↵].  
Selecting "Reset" will set your TV to the factory settings.
- 2 Press ↑, ↓, ← or → to adjust the setting of your selected item, then press [↵].
- 3 Repeat the above steps to adjust other items.  
The adjusted settings will be received when you select "Custom".

- 🔧: • "Hue" can be adjusted for the NTSC color system only.
- Reducing "Sharpness" can also reduce picture noise.

# K "Sound" setting

Press WEGA GATE and select "Settings".

Press **▲** or **▼** to select the "Sound" icon (🔊), then press **[↵]**.

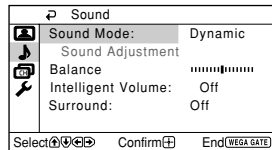

"Sound Mode" (KV-AW212M83 only)	Choose either "Dynamic" (low and high tones), "Standard" (voice and high tones) or "Custom"*.
"Balance"	Press <b>▼</b> or <b>◀</b> to emphasize the left speaker. Press <b>▲</b> or <b>▶</b> to emphasize the right speaker.
"Intelligent Volume"	Adjust the volume of all program numbers and video inputs automatically. Press <b>▲</b> or <b>▼</b> to select "On", then press <b>[↵]</b> . To cancel, select "Off", then press <b>[↵]</b> .
"Surround" (KV-AW212M83 only)	Choose either "On" (surround), "Simulated" (stereo-like monaural sound) or "Off".

\* You can adjust the setting to your personal preference in the "Sound Adjustment" option only when the "Custom" mode is selected.

## Adjusting the "Sound Adjustment" items under "Custom" mode (KV-AW212M83 only)

The 5-Band Graphic Equalizer feature allows you to adjust sound frequency settings of "Custom" mode in the menu.

**1** Make sure that "Adjust" is selected, then press **[↵]**.

Selecting "Reset" will set your TV to the factory settings.

**2** Press **◀** or **▶** to select the desired sound frequency, then press **▲** or **▼** to adjust the setting and press **[↵]**.

The adjusted settings will be received when you select "Custom".



- 🔊:
- Adjusting higher frequency will affect higher pitched sound and adjusting lower frequency will affect lower pitched sound.
  - You may display the settings directly by using the 🔊 button on the remote control (see **[H]**).

# L "Channel Setup" setting

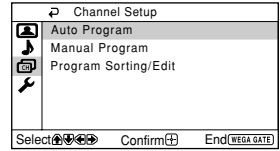
Press WEGA GATE and select "Settings".  
Press  $\uparrow$  or  $\downarrow$  to select the "Channel Setup"  
icon () , then press  $\leftarrow$ .



---

"Auto Program"	Preset channels automatically.
"Manual Program"	Manually preset desired channels and channels that cannot be preset automatically (see <b>Presetting channels manually</b> ).
"Program Sorting/Edit"	<p>Sort and edit the channels.</p> <p>(a) If you wish to keep the channels in the current condition, press WEGA GATE to exit.</p> <p>(b) Press <math>\uparrow</math> or <math>\downarrow</math> to select the program number with the channel you wish to change. The selected channel will appear on the screen.</p> <p>(c) If you wish to store the channels in a different order: (1) Press <math>\rightarrow</math> to enter sorting mode. (2) Press <math>\uparrow</math> or <math>\downarrow</math> to select the new program number position for your selected channel, then press <math>\leftarrow</math>.</p> <p>(d) If you wish to edit the channels, press <math>\leftarrow</math> to change to edit mode. Press <math>\rightarrow</math> until the mode that you wish to edit is highlighted: Label, Skip,  (block symbol). Then press <math>\leftarrow</math>.</p> <p>(1) To label, press <math>\uparrow</math> or <math>\downarrow</math> to select the alphanumeric characters for the label. Then press <math>\leftarrow</math>.</p> <p>(2) To skip the program number, press <math>\uparrow</math> or <math>\downarrow</math> to select "On". Then press <math>\leftarrow</math>. You can skip this program number when using PROG +/-.</p> <p>(3) To block unwanted program number, press <math>\uparrow</math> or <math>\downarrow</math> to select . Then press <math>\leftarrow</math>.</p> <p>(e) Repeat step (b) to (d) if you wish to change other channels.</p>

---

Press WEGA GATE to exit.





- :
- If you preset a blocked program number, that program number will be unblocked automatically.
  - If you sort a blocked program, that program will remain blocked.

## ***“Channel Setup” setting (continued)***

### **Presetting channels manually**



---

**1** After selecting “Manual Program”, select the program number to which you want to preset a channel.

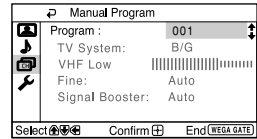





- (1) Make sure “Program” is selected, then press .
- (2) Press  or  until the program number you want to preset appears on the menu, then press .













**2** Select the desired channel.

- (1) Make sure either “VHF Low”, “VHF High” or “UHF” is selected, then press .
- (2) Press  or  until the desired channel’s broadcast appears on the TV screen, then press .

**3** If the sound of the desired channel is abnormal, select the appropriate TV system.







- (1) Press  or  to select “TV System”, then press .
- (2) Press  or  until the sound becomes normal, then press .

**4** If you are not satisfied with the picture and sound quality, you may be able to improve them by using the “Fine” tuning feature.

- (1) Press  or  to select “Fine”, then press .
- (2) Press  or  to select “Manual”, then press .
- (3) Press , ,  or  until the picture and sound quality are optimal, then press .

The + or – icon on the menu flashes while tuning.

**5** If the TV signal is too strong (picture distorted; picture with lines; signal interference) or weak (snowy picture), you may be able to improve the picture quality by setting the “Signal Booster” feature.

- (1) Press  or  to select “Signal Booster”, then press .
  - (2) Press  or  to select either “Off” (for picture distorted; picture with lines; signal interference) or “Auto” (for snowy picture), then press .
-

# M "Setup" setting

Press WEGA GATE and select "Settings".  
Press  $\blacktriangle$  or  $\blacktriangledown$  to select the "Setup" icon (🔧),  
then press  $\left[ \begin{smallmatrix} \blacktriangle \\ \blacktriangledown \end{smallmatrix} \right]$ .

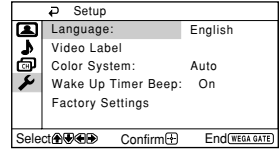

"Language"	Change the menu language. Press $\blacktriangle$ or $\blacktriangledown$ to select either "English" or "عربي" (Arabic), then press $\left[ \begin{smallmatrix} \blacktriangle \\ \blacktriangledown \end{smallmatrix} \right]$ .
"Video Label"	Label the connected equipment. (1) Select "Video Input" and press $\left[ \begin{smallmatrix} \blacktriangle \\ \blacktriangledown \end{smallmatrix} \right]$ . Press $\blacktriangle$ or $\blacktriangledown$ to select the input you want to label, then press $\left[ \begin{smallmatrix} \blacktriangle \\ \blacktriangledown \end{smallmatrix} \right]$ . (2) Select "Label" and press $\left[ \begin{smallmatrix} \blacktriangle \\ \blacktriangledown \end{smallmatrix} \right]$ , then press $\blacktriangle$ or $\blacktriangledown$ to select the label options: "Video 1"/"Video 2", "VCR", "SAT", "Game" or "Edit"*. * You may edit the video label to your favorite name. Press $\blacktriangle$ or $\blacktriangledown$ to select alphanumeric characters for the label, then press $\left[ \begin{smallmatrix} \blacktriangle \\ \blacktriangledown \end{smallmatrix} \right]$ .
"Color System"	Select the color system. Press $\blacktriangle$ or $\blacktriangledown$ to select either "Auto", "PAL", "SECAM", "NTSC3.58" or "NTSC4.43", then press $\left[ \begin{smallmatrix} \blacktriangle \\ \blacktriangledown \end{smallmatrix} \right]$ . Normally, set this to "Auto".
"Wake Up Timer Beep" (KV-AW212M83 only)	Allow your TV to emit beeping sound when TV switches on automatically using wake up timer. Press $\blacktriangle$ or $\blacktriangledown$ to select "On", then press $\left[ \begin{smallmatrix} \blacktriangle \\ \blacktriangledown \end{smallmatrix} \right]$ . To cancel, select "Off", then press $\left[ \begin{smallmatrix} \blacktriangle \\ \blacktriangledown \end{smallmatrix} \right]$ .
"Factory Settings"	Reset your TV to factory settings. Press $\left[ \begin{smallmatrix} \blacktriangle \\ \blacktriangledown \end{smallmatrix} \right]$ and press $\blacktriangle$ or $\blacktriangledown$ to select "Yes". Then press $\left[ \begin{smallmatrix} \blacktriangle \\ \blacktriangledown \end{smallmatrix} \right]$ . Your TV will go blank for a few seconds, then the "Initial Setup" menu will appear. To cancel, select "No", then press $\left[ \begin{smallmatrix} \blacktriangle \\ \blacktriangledown \end{smallmatrix} \right]$ .

- 🔊:
- To ensure the beeping sound can be heard, you must set an appropriate volume level on your TV and make sure the TV is not in mute condition.
  - To stop the beeping sound, press any buttons on the remote control or front panel.
  - If no button is pressed for three minutes, the beeping sound will automatically go off.