

Portable CD Player

Operating Instructions

About the area code

The area code of the location in which you purchased the CD player is shown on upper left of the bar code label on the package.

For accessories supplied with your CD player, check the area code of your model and see "Accessories (supplied/optional)."



"WALKMAN" is a trademark of Sony Corporation.

D-EJ775

WARNING

To prevent fire or shock hazard, do not expose the unit to rain or moisture.

Do not install the appliance in a confined space, such as a bookcase or built-in cabinet.

To prevent fire, do not cover the ventilation of the apparatus with newspapers, tablecloths, curtains, etc. And don't place lighted candles on the apparatus.

To prevent fire or shock hazard, do not place objects filled with liquids, such as vases, on the apparatus.

CAUTION

The use of optical instruments with this product will increase eye hazard.

Certain countries may regulate disposal of the battery used to power this product. Please consult with your local authority.

CAUTION

- INVISIBLE LASER RADIATION WHEN OPEN
- DO NOT STARE INTO BEAM OR VIEW DIRECTLY WITH OPTICAL INSTRUMENTS

For the customers in Australia

The supply cord of the AC power adaptor cannot be replaced; if the cord is damaged, the AC power adaptor should be discarded.

For the customers in the USA and Canada

RECYCLING NICKEL CADMIUM BATTERIES

Nickel cadmium batteries are recyclable. You can help preserve our environment by returning your used rechargeable batteries to the collection and recycling location nearest you.

Note: In some areas the disposal of nickel cadmium batteries in household or business trash may be prohibited.

For more information regarding recycling of rechargeable batteries, call toll free 1-800-822-8837, or visit <http://www.rbrc.org/>.

Caution: Do not handle damaged or leaking nickel cadmium batteries.



Table of Contents

Getting started

Locating the controls 4

Playing a CD

1. Connect your CD player. 6

2. Insert a CD. 6

3. Play a CD. 6

Playback options 8

Available features

G-PROTECTION function 9

Emphasizing the bass sound (SOUND) 9

Protecting your hearing (AVLS) 10

Locking the controls (HOLD) 10

Turning off the operation beep sound 11

Connecting your CD player

Connecting a stereo system 12

Connecting to a power source

Using the rechargeable batteries 13

Using the dry batteries 15

Notes on the power source 15

Additional information

Precautions 16

Maintenance 16

Troubleshooting 17

Specifications 19

Accessories (supplied/optional) .. Back cover

Getting started

Locating the controls

For details, see pages in parentheses.

CD player (front)

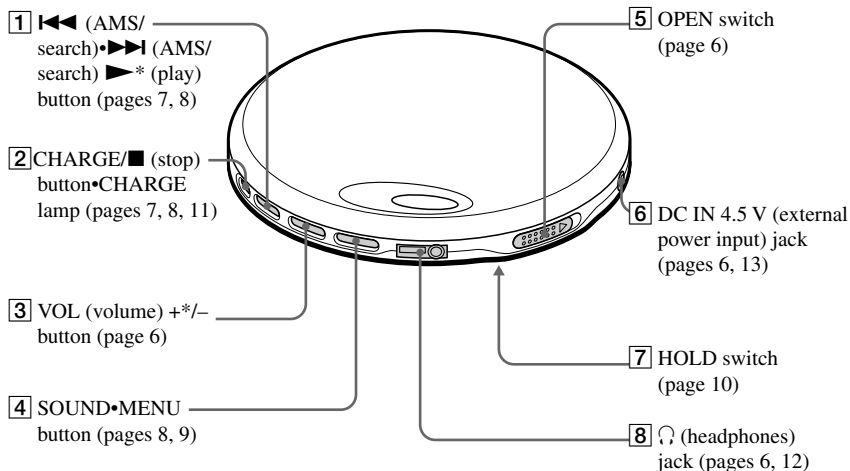

CD player (inside)

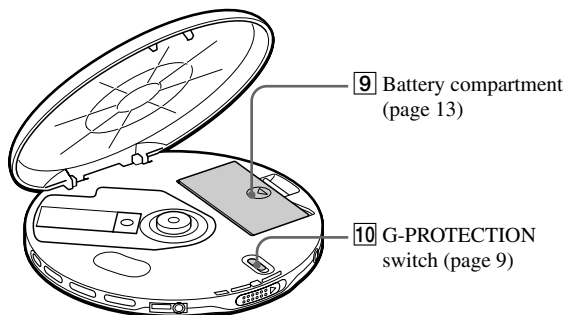

*The button has a tactile dot.

Remote control

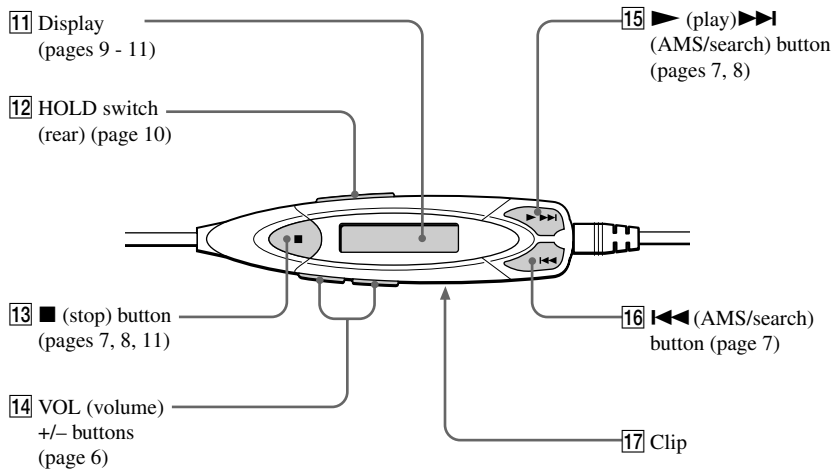

Note

Use only the supplied remote control. You cannot operate this CD player with the remote control supplied with other CD players.

Playing a CD

You can also use rechargeable batteries or dry batteries as a power source.

1. Connect your CD player.

- 1 Connect the AC power adaptor.
- 2 Connect the headphones/earphones with remote control.

For models supplied with the remote control

- Connect the plug of the headphones/earphones to the remote control.
- Connect the headphones/earphones to the remote control firmly. A loose connection may cause noise during playback.

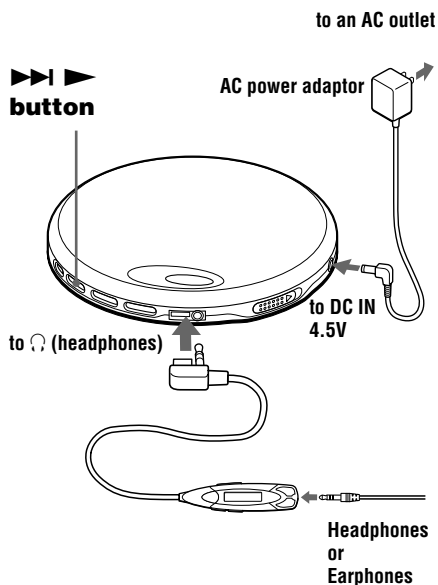

2. Insert a CD.

- 1 Slide OPEN to open the lid.

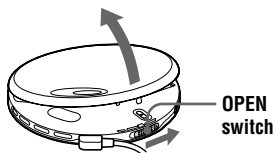

- 2 Place the CD on the tray and close the lid.

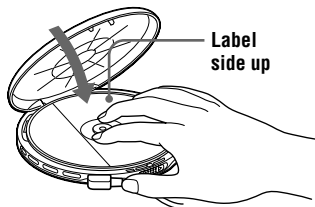

3. Play a CD.

Press .

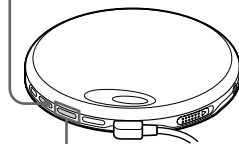

Adjust the volume by pressing VOL +/-.

| To | Press |
|---|--|
| Play (from the point you stopped) | ▶▶▶▶▶ (▶▶▶▶▶ for the remote control) |
| Play (from the first track) | ▶▶▶▶▶ (▶▶▶▶▶ for the remote control) for 2 seconds or more |
| Stop | CHARGE/■ (■ for the remote control)*2 |
| Find the beginning of the current track (AMS*1) | ◀◀◀ once quickly*2 |
| Find the beginning of the previous tracks (AMS) | ◀◀◀ repeatedly*2, *3 |
| Find the beginning of the next track (AMS) | ▶▶▶▶▶ (▶▶▶▶▶ for the remote control) once quickly*2, *3 |
| Find the beginning of the succeeding tracks (AMS) | ▶▶▶▶▶ (▶▶▶▶▶ for the remote control) repeatedly*2, *3 |
| Go backwards quickly (search) | Hold down ◀◀◀*2 |
| Go forward quickly (search) | Hold down ▶▶▶▶▶*2 (▶▶▶▶▶ for the remote control) |

*1 Automatic Music Sensor

*2 These operations can be done during play.

*3 After you have played the last track, you can return to the beginning of the first track by pressing ▶▶▶▶▶ (▶▶▶▶▶ for the remote control). Similarly, if you are at the first track, you can locate the last track by pressing ◀◀◀.

About the display

- When you press ▶▶▶▶▶ (▶▶▶▶▶ for the remote control) after changing the CD or turning off and on the player, the total number of tracks in the CD and total playing time appear for about two seconds.
- During play, the track number and the elapsed playing time of the current track appear.

If the volume level does not increase

- If “AVLS” flashes in the display, hold down SOUND until “AVLS” disappears from the display. For details, see “Protecting your hearing (AVLS).”

About CD-Rs/CD-RWs

This CD player can play CD-Rs/CD-RWs recorded in the CD-DA format*, but playback capability may vary depending on the quality of the disc and the condition of the recording device.

* CD-DA is the abbreviation for Compact Disc Digital Audio. It is a recording standard used for Audio CDs.

Removing the CD

Remove the CD while pressing the pivot in the center of the tray.

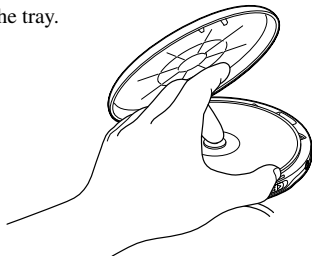

Playback options

You can enjoy various ways of playback using MENU.

MENU button

Each time you press the button, you can change the playback mode.

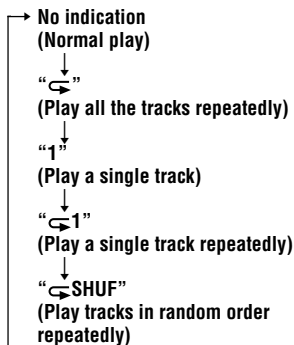

Display on the remote control

Display when MENU is pressed



button

CHARGE/■
button

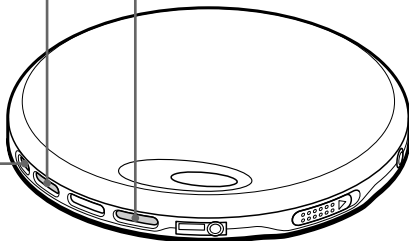

■ button

▶▶▶ button

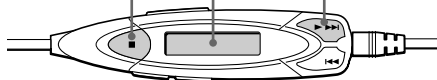

► Available features

G-PROTECTION function

The G-PROTECTION function has been developed to provide excellent protection against sound skipping while jogging. This function provides a higher level of shock protection than the traditional one.

Set G-PROTECTION (under the lid) to "ON."



While jogging, be sure to hold your CD player with the  jack facing upward.

To turn off the G-PROTECTION function

Set G-PROTECTION to "OFF."

Note

Sound may skip:

- if the CD player receives stronger continuous shock than expected,
- if a dirty or scratched CD is played or
- when using poor-quality CD-Rs/CD-RWs or if there is a problem with the recording device or application software.

Emphasizing the bass sound (SOUND)

You can emphasize the bass-boosted sound.

Press SOUND to select "BASS 1" or "BASS 2."

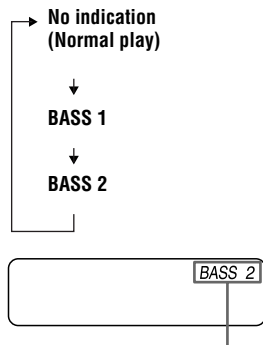

The selected sound mode is displayed.

"BASS 2" enhances the bass sound more than "BASS 1."

Note

If the sound is distorted when using the SOUND function, turn down the volume.

Protecting your hearing

(AVLS)

The AVLS (Automatic Volume Limiter System) function keeps down the maximum volume to protect your hearing.

Press and hold SOUND until “AVLS” appears in the display.

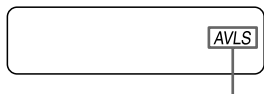

Flashes when the volume is turned up and beyond a certain level.

To turn off the AVLS function

Hold down SOUND until “AVLS” disappears from the display.

Locking the controls

(HOLD)

You can lock the controls on your CD player to prevent accidental button presses.

Slide HOLD in the direction of the arrow.

CD player



Remote control

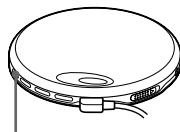

The CHARGE lamp flashes when the HOLD function is activated.

You can use the HOLD function with both the CD player and remote control. You can still operate your CD player using the remote control when HOLD on the remote control is set to off.

To unlock the controls

Slide HOLD in the opposite direction of the arrow.

Note

No display appears in the display on the remote control even when the HOLD function is activated.

Turning off the operation beep sound

You can turn off the beep sound that is heard from your headphones/earphones when you operate your CD player.

1 Remove the power source (AC power adaptor, rechargeable batteries or dry batteries) from the CD player.

2 Connect the power source while pressing CHARGE/■ on the CD player or ■ on the remote control.

To turn on the beep sound

Remove the power source and then connect the power source without pressing CHARGE/■ or ■.

► Connecting your CD player

Connecting a stereo system

You can listen to CDs through a stereo system and record CDs on a cassette tape. For details, see the instruction manual that comes with the connected device.

Be sure to turn off all connected devices before making connections.

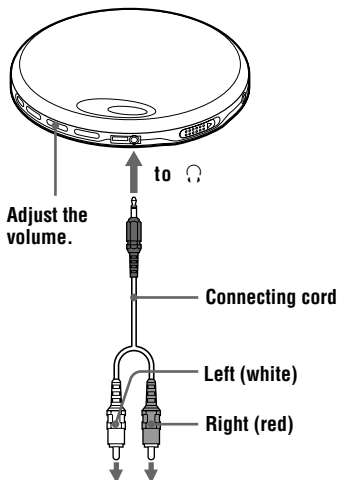

Notes

- Before you play a CD, turn down the volume of the connected device to avoid damaging the connected speakers.
- Use the AC power adaptor for recording. If you use the rechargeable batteries or dry batteries as a power source, batteries may become completely depleted during recording.
- Adjust the volume properly on the CD player and the connected device so that the sound will not be distorted or noisy.

About the G-PROTECTION function when using the connecting cord

- To record high quality CD sound, set the G-PROTECTION switch to "OFF."

► Connecting to a power source

You can use the following power sources:

- Rechargeable batteries
- AC power adaptor (see “Playing a CD”)
- LR6 (size AA) alkaline batteries

For the battery life and charging time of the rechargeable batteries, see “Specifications.”

Using the rechargeable batteries

Charge the rechargeable batteries before using them for the first time. You can use only the following rechargeable batteries for your CD player.

- NC-WMAA
- NH-WM2AA (NH-WMAA × 2)

- 1** Open the battery compartment lid inside your CD player.

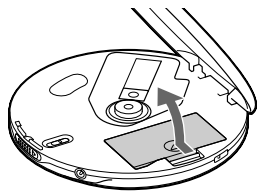



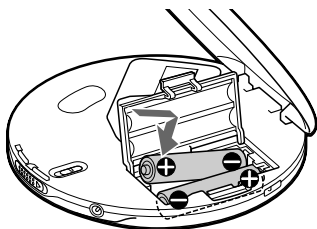

- 2** Insert two rechargeable batteries by matching the ⊕ to the diagram in the battery compartment and close the lid until it clicks into place.

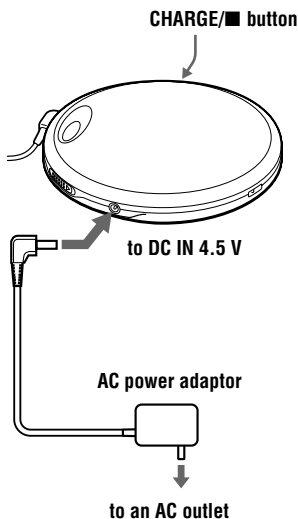

Insert the ⊖ end first (for both batteries)

- 3** Connect the AC power adaptor to the DC IN 4.5 V jack of your CD player and an AC outlet, then press CHARGE/■ to start charging.



The CD player charges the batteries. In the display on the remote control, the indicator sections of  light up in succession. The CHARGE lamp on the player turns on. When the batteries are completely charged, the CHARGE lamp and  indicator get turned off. If you press CHARGE/■ after the charge has already been completed, the  indicator flashes and “Full” appears in the display.

- 4** Disconnect the AC power adaptor.

(Continued)

Using the rechargeable batteries

To remove the rechargeable batteries

Remove the batteries as illustrated below.

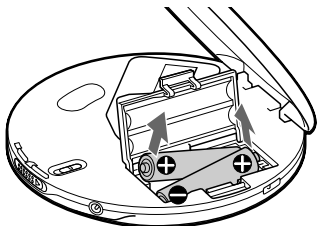

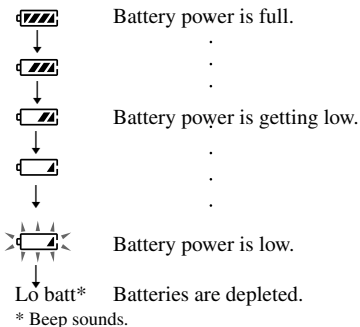

When to charge the rechargeable batteries

You can check the remaining power of the batteries in the display.



To keep the original battery capacity for a long time, charge the batteries only when they are completely depleted.

Notes

- The indicator sections of  roughly shows the remaining battery power. One section does not always indicate one-fourth of the battery power.
- Depending on operating conditions, the indicator sections of  may increase or decrease.

When to replace the rechargeable batteries

If the battery life becomes shorter by about half, replace the batteries with new rechargeable batteries.

Note on the rechargeable batteries

If the battery is new or has not been used for a long time, it may not be charged completely until you charge and discharge it several times.

Note on carrying the rechargeable batteries

Use the supplied battery carrying case to prevent unexpected heat. If the rechargeable batteries and the metallic objects get contacted, heat or fire may occur due to a short circuit.

To attach the battery compartment lid

If the battery compartment lid is detached by an accidental drop, excessive force, etc., attach it as illustrated below.

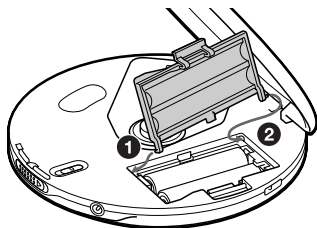

Using the dry batteries

Use only the following dry battery type for your CD player:

- LR6 (size AA) alkaline batteries

Note

Be sure to remove the AC power adaptor when using the dry batteries.

1 Open the battery compartment lid.

2 Insert two LR6 (size AA) batteries by matching the \oplus to the diagram in the battery compartment. Insert the \ominus end first (for both batteries)

To remove the batteries

Remove the batteries in the same way as rechargeable batteries.

When to replace the batteries

You can check the remaining power of the batteries in the display.



Battery power is full.



Battery power is getting low.



Battery power is low.

Lo batt* Batteries are depleted.

* Beep sounds.

When the batteries are depleted, replace both batteries with new ones.

Notes on the power source

Disconnect all power sources when the CD player is not used.

On AC power adaptor

- Use only the AC power adaptor supplied or recommended in “Accessories (supplied/ optional).” Do not use any other AC power adaptor. It may cause a malfunction.

Polarity of the plug



- When disconnecting the AC power adaptor from the AC outlet, grasp the adaptor itself. Do not pull it by the cord.
- Do not touch the AC power adaptor with wet hands.

On rechargeable batteries and dry batteries

- Do not charge the dry batteries.
- Do not throw the batteries into fire.
- Do not carry the batteries with coins or other metallic objects. It can generate heat if the positive and negative terminals of the battery are accidentally contacted by a metallic object.
- Do not mix rechargeable batteries with dry batteries.
- Do not mix new batteries with old ones.
- Do not use different types of batteries together.
- When the batteries are not to be used for a long time, remove them.
- If battery leakage occurs, wipe off any deposit in the battery compartment, and install new batteries. In case the deposit adheres to you, wash it off thoroughly.

► Additional information

Precautions

On safety

- Should any solid objects or liquid fall into the CD player, unplug it and have it checked by qualified personnel before operating it any further.
- Do not put any foreign objects in the DC IN 4.5 V (external power input) jack.

On the CD player

- Keep the lens on the CD player clean and do not touch it. If you do so, the lens may be damaged and the CD player will not operate properly.
- Do not put any heavy object on top of the CD player. The CD player and the CD may be damaged.
- Do not leave the CD player in a location near heat sources, or in a place subject to direct sunlight, excessive dust or sand, moisture, rain, mechanical shock, unlevelled surface, or in a car with its windows closed.
- If the CD player causes interference to the radio or television reception, turn off the CD player or move it away from the radio or television.
- Discs with non-standard shapes (e.g., heart, square, star) cannot be played on this CD player. Attempting to do so may damage the CD player. Do not use such discs.

On handling CDs

- To keep the CD clean, handle it by its edge. Do not touch the surface.
- Do not stick paper or tape onto the CD.

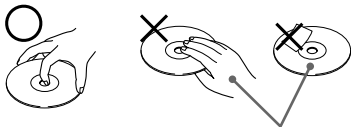

Not these ways

- Do not expose the CD to direct sunlight or heat sources such as hot air ducts. Do not leave the CD in a car parked under direct sunlight.

On headphones/earphones

Road safety

Do not use headphones/earphones while driving, cycling, or operating any motorized vehicle. It may create a traffic hazard and is illegal in some areas. It can also be potentially dangerous to play your headsets at high volume while walking, especially at pedestrian crossings. You should exercise extreme caution or discontinue use in potentially hazardous situations.

Preventing hearing damage

Avoid using headphones/earphones at high volume. Hearing experts advise against continuous, loud and extended play. If you experience a ringing in your ears, reduce volume or discontinue use.

Consideration for others

Keep the volume at a moderate level. This will allow you to hear outside sounds and to be considerate to the people around you.

Maintenance

To clean the casing

Use a soft cloth slightly moistened in water or a mild detergent solution. Do not use alcohol, benzine or thinner.

Troubleshooting

Should any problem persist after you have checked these symptoms, consult your nearest Sony dealer.

| Symptom | Cause and/or corrective actions |
|--|--|
| The volume does not increase even if you press the VOL + button repeatedly. | → Press and hold SOUND until "AVLS" disappears from the display. (page 10) |
| No sound, or noise is heard. | → Connect the plugs firmly. (page 6) → Plugs are dirty. Clean the plugs with a dry soft cloth periodically. |
| The playing time is too short when powered with the dry batteries. | → Check that you are using alkaline batteries and not manganese batteries. (page 15) → Replace the batteries with new LR6 (size AA) alkaline batteries. (page 15) |
| The playing time is too short when powered with the rechargeable batteries. | → Charge and discharge the rechargeable batteries several times. (pages 13, 14) |
| "Lo batt" or "00" appears in the display. The CD does not play. | → The rechargeable batteries are used up completely. Charge the batteries. (page 13) → Replace the batteries with new LR6 (size AA) alkaline batteries. (page 15) |
| "HI dc In" appears in the display. | → Use only the AC power adaptor or car battery cord in "Accessories (supplied/optional)." (page 20) → Remove all power sources, then insert the batteries or connect the AC power adaptor again. (pages 6, 13 - 15) |
| The CD does not play or "no DISC" appears in the display when a CD is placed in the CD player. | → The buttons are locked. Slide the HOLD switch back. (page 10) → The CD is dirty or defective. (page 16) → Check that the CD is inserted with the label side up. (page 6) → Moisture condensation has occurred. Leave the CD player aside for several hours until the moisture evaporates. → Close the lid of the battery compartment firmly. (page 13) → Make sure the batteries are inserted correctly. (pages 13 - 15) → Connect the AC power adaptor to an AC outlet securely. (page 6) → The CD-R/CD-RW was not finalized. Finalize the CD-R/CD-RW with the recording device. → There is a problem with the quality of the CD-R/CD-RW, recording device, or application software. |
| The CHARGE lamp on the player flashes when you press a button, and the CD does not play. | → The buttons are locked. Slide the HOLD switch back. (page 10) |

(Continued)

Troubleshooting

| Symptom | Cause and/or corrective action |
|---|--|
| The CD player does not start charging. | <ul style="list-style-type: none">→ During stop, press CHARGE/■. (page 13)→ You pressed ■ on the remote control. Press CHARGE/■ on the CD player. (page 11) |
| Playback starts from the point you stopped. (resume function) | → The resume function is working. To start play from the first track, press ►►►►► (►►►►► for the remote control) for 2 seconds or more, or open the lid of the CD player. Or remove all power sources, then insert the batteries or connect the AC power adaptor again. (pages 6, 7, 13, 15) |
| Rustling noise is heard from the CD. | → Close the lid of the battery compartment firmly. (page 13) |
| When closing the lid of the CD player, the CD starts to rotate. | → The CD player is reading the information on the CD. It is not malfunctioning. |
| You cannot operate the CD player properly using the remote control. | → The buttons on the CD player are kept pressed by mistake. |
| When using with a connected stereo system, the sound is distorted or noisy. | → Adjust the volume of the CD player and the connected device. (page 12) |

Specifications

System

Compact disc digital audio system

Laser diode properties

Material: GaAlAs

Wavelength: $\lambda = 780 \text{ nm}$

Emission duration: Continuous

Laser output: Less than $44.6 \mu\text{W}$

(This output is the value measured at a distance of 200 mm from the objective lens surface on the optical pick-up block with 7 mm aperture.)

D-A conversion

1-bit quartz time-axis control

Frequency response

40 - 20 000 Hz ± 1 dB (measured by JEITA CP-307)

Output (at 4.5 V input level)

Headphones (stereo minijack)

Approx. 5 mW + Approx. 5 mW at 16Ω

(Approx. 0.5 mW + Approx. 0.5 mW at 16Ω)*

*For the customers in France

Power requirements

For the area code of the model you purchased, check the upper left side of the bar code on the package.

- Two Sony NC-WMAA rechargeable batteries: 2.4 V DC
- Sony NH-WM2AA rechargeable batteries: 2.4 V DC
- Two LR6 (size AA) batteries: 3 V DC
- AC power adaptor (DC IN 4.5 V jack): U2/U/CA2/E92/MX2/TW2/BR3 model: 120 V, 60 Hz

CED/CET/CEW/CEX/CE7/EE/EE1/E13/G5/

G6/G7/G8/BR1 model:

220 - 230 V, 50/60 Hz

CEK/3CE7 model: 230 - 240 V, 50 Hz

AU2 model: 240 V, 50 Hz

JE.W/E33/EA3/KR4 model: 100 - 240 V, 50/60 Hz

HK2 model: 220 V, 50/60 Hz

AR1/CNA model: 220 V, 50 Hz

Battery life* (approx. hours)

(When you use the CD player on a flat and stable surface.)

Playing time varies depending on how the CD player is used.

| When using | G-PROTECTION function | |
|---|-----------------------|-----|
| | on | off |
| Two NC-WMAA (charged for about 3 hours**) | 12 | 8 |
| NH-WM2AA (charged for about 5 hours**) | 22 | 17 |
| Two Sony alkaline batteries LR6(SG) (produced in Japan) | 41 | 29 |

* Measured value by the standard of JEITA (Japan Electronics and Information Technology Industries Association).

** Charging time varies depending on how the rechargeable battery is used.

Operating temperature

5°C - 35°C (41°F - 95°F)

Dimensions (w/h/d) (excluding projecting parts and controls)

Approx. $136.0 \times 19.8 \times 136.0 \text{ mm}$

($5 \frac{3}{8} \times 25/32 \times 5 \frac{3}{8} \text{ in.}$)

Mass (excluding accessories)

Approx. 160 g (5.7 oz.)

Design and specifications are subject to change without notice.

Accessories (supplied/optional)

Supplied accessories

For the area code of the location in which you purchased the CD player, check the upper left side of the bar code on the package.

- AC power adaptor (1)
- Headphones/earphones with remote control (1)
- Rechargeable batteries (2)
- Battery carrying case (1)
- AC plug adaptor (1)*¹

*¹ Supplied with JE.W and E33 models

Optional accessories

| | |
|---|--------------------------|
| AC power adaptor | AC-E45HG |
| Active speaker system | SRS-T55 SRS-Z500 |
| Car battery cord | DCC-E345 |
| Car battery cord with car connecting pack | DCC-E34CP |
| Car connecting pack | CPA-9C |
| Connecting cord | RK-G129 RK-G136 |
| Rechargeable battery | NH-WM2AA |
| Earphones | MDR-E848LP MDR-EX70LP |
| Headphones | MDR-A44L MDR-A110LP |

When using optional headphones, use only headphones with stereo miniplugs. You cannot use headphones with micro plugs.

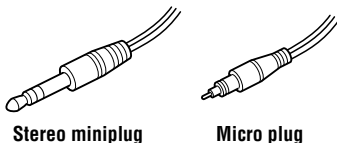

Your dealer may not handle some of the accessories listed above. Please ask the dealer for detailed information about the accessories in your country.