

# SONY



## IC Recorder

Operating Instructions  
ICD-B500

**IC RECORDER**

©2007 Sony Corporation Printed in China

### For the customers in the U.S.A.

The following FCC statement applies only to the version of this model manufactured for sale in the USA. Other versions may not comply with FCC technical regulations.

### INFORMATION

This equipment has been tested and found to comply with the limits for a Class B digital device, pursuant to Part 15 of the FCC Rules. These limits are designed to provide reasonable protection against harmful interference in a residential installation. This equipment generates, uses, and can radiate radio frequency energy and, if not installed and used in accordance with the instructions, may cause harmful interference to radio communications. However, there is no guarantee that interference will not occur in a particular installation. If this equipment does cause harmful interference to radio or television reception, which can be determined by turning the equipment off and on, the user is encouraged to try to correct the interference by one or more of the following measures:

- Reorient or relocate the receiving antenna.
- Increase the separation between the equipment and receiver.
- Connect the equipment into an outlet on a circuit different from that to which the receiver is connected.
- Consult the dealer or an experienced radio/TV technician for help.

### The unit does not operate.

- The batteries have been inserted with incorrect polarity.
- The batteries are weak.
- The buttons are locked with the HOLD switch. (If you press any button, "HOLD" will flash for 3 seconds.)

### No sound comes from the speaker.

- The ear receiver or headphones are plugged in.
- The volume is turned down completely.

### "FULL" is displayed and you cannot start recording.

- The memory is full. Erase some of the messages.
- 99 messages have been recorded in the selected folder. Select another folder or erase some of the messages.

### Noise is heard.

- An object, such as your finger, etc., accidentally rubbed or scratched the unit during recording so that noise was recorded.
- The unit was placed near an AC power source, a fluorescent lamp or a mobile phone during recording or playback.
- Plug of the connected microphone was dirty when recording. Clean the plug.
- Ear receiver/headphones plug is dirty. Clean the plug.

### Recording level is low.

- Set the microphone sensitivity to "H (high)" using the menu.

### Recording is interrupted.

- The advanced VOR function is activated. Set VOR to "OFF."

### Recording level is unstable (when recording music, etc.).

- This unit is designed to automatically adjust the recording level when recording meetings, etc., and is not suitable for music recording.
- "-Y-M-D-" or "-:-:-" is displayed.
- You have not set the clock.

### "-Y-M-D-" or "-:-:-" is displayed on the REC DATE display.

- The date and time of recording will not be displayed if you recorded the message when the clock was not set.

### You cannot divide a message.

- You cannot divide a message in a folder which has 99 messages.
- If you divide messages frequently, the unit may become unable to divide a message.
- You cannot divide a message in the first or the last 1 second of a message.

### It takes longer for the unit to start operation.

- If you divide messages too frequently while the unit is recording them, the following phenomenon may occur: The OPR indicator keeps flashing, and you cannot operate the unit for a certain period. This is not a malfunction. Wait until the OPR indicator goes off.

### You cannot record messages up to the maximum recording time.

- If you record messages in a mixture of HQ, SP and LP modes, the recordable time varies from the maximum HQ mode recording time to the maximum LP mode recording time.
- No more recording can be made when 99 messages each have been recorded in a folder.
- Due to the limitation of the IC recording system, this unit records in the minimum recording unit. If the length of each message cannot be divided by the minimum recording unit, the remaining recording time may decrease by more than the total length of the messages.

### The unit does not operate correctly.

- Take out the batteries and insert them again.

Please note that recorded messages may be erased during service or repair work.

### ▶Getting started

## Step 1: Installing the Batteries

### 1 Slide and lift the battery compartment lid.

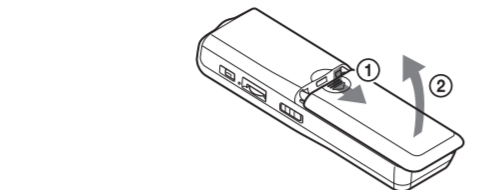

### 2 Insert two LR03 (size AAA) alkaline batteries with correct polarity, and close the lid.

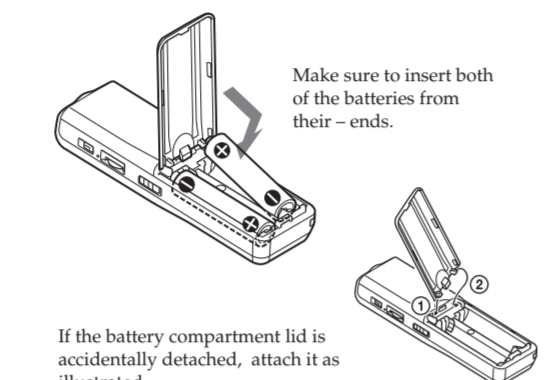

Clock setting display appears when you insert batteries for the first time, or when you replace the batteries with new ones. Please refer to Steps 2 to 3 in "Step 2: Setting the Clock" to set the date and time.

## Step 2: Setting the Clock

Clock setting display appears when you insert batteries for the first time, or when you replace the batteries with new ones. In this case, proceed from step 2. Remove the film on the display window before you use the IC recorder.

### 1 Display the clock setting display.

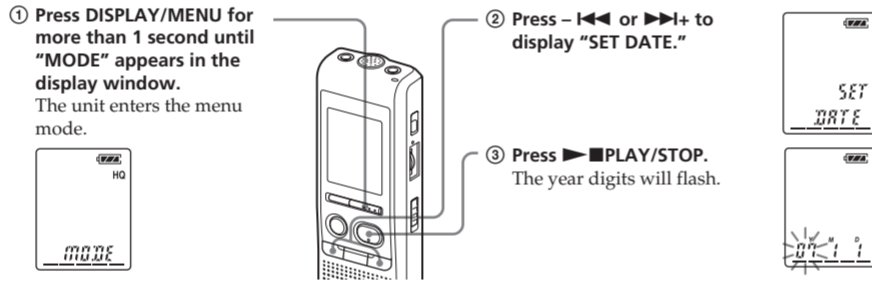

### 2 Set the date.

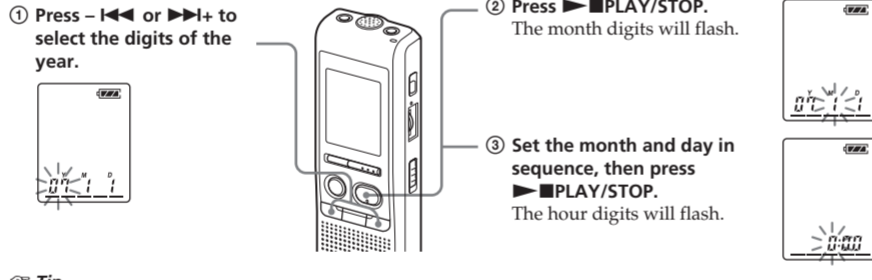

☞ Tip To set the date to Year 2007, display "07Y."

### 3 Set the time.

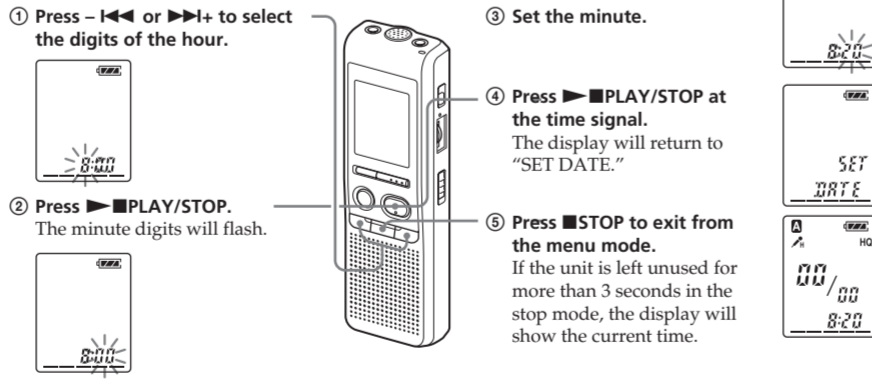

☞ Tip This unit does not have a power on/off switch. The display is shown at all times.

#### Power source

To turn the power off, slide the HOLD switch in the direction of the arrow in the stop mode.  
To turn the power on, slide the HOLD switch in the opposite direction from that of the arrow, and then press any operation button.

#### Replacing the batteries

The battery indicator in the display window shows the battery condition.  
When " " flashes, replace the batteries with new ones.  
When " " flashes, the batteries are exhausted and the unit will stop operation.

#### Battery life\*

With continuous use, approx. 11 hours recording/7.5 hours playback in the HQ mode, and approx. 22 hours recording/11 hours playback in the SP and LP modes is possible.  
\* Using Sony alkaline batteries LR03 (size AAA)  
\* When playing back through the internal speaker with the medium volume level  
The battery life may shorten depending on the operation of the unit.

#### Notes

- Do not use manganese batteries for this unit.
- When you replace the batteries with new ones, the clock setting display appears. In this case, set the date and time again. The recorded messages and alarm setting, however, will remain.
- When replacing the batteries, be sure to replace both batteries with new ones.
- Do not charge dry batteries.
- When you are not going to use the unit for a long time, remove the batteries to prevent damage from battery leakage and corrosion.
- The unit is accessing data while "ACCESS" appears in the display window. While accessing, do not remove the batteries. Doing so may damage the data.

### ▶Basic Operations

## Recording Messages

You can record up to 99 messages in each of the four folders (A, B, C, and D). Since a newly recorded message is automatically added behind the last recorded message, you can start recording quickly without searching for the end of the last recording.

e.g.

Message 1	Message 2	Newly recorded message	Blank space
-----------	-----------	------------------------	-------------

#### Note

Before making a long recording, be sure to insert new batteries and check the battery indicator.

### 1 Select the recording mode.

See "Changing the Recording Mode" on the reverse side.

### 2 Select the folder.

See "Selecting the Folder."

### 3 Start recording.

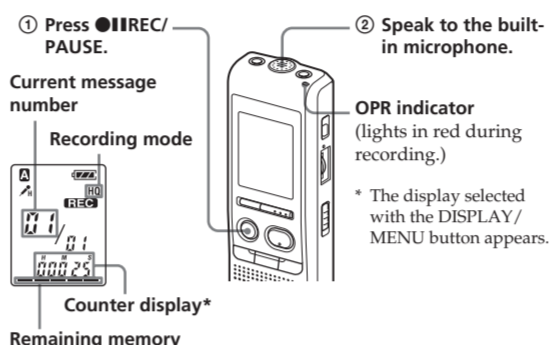

You do not need to keep pressing I/REC/PAUSE while recording.

### 4 Stop recording.



If you do not change the folder after you stop recording, the next time you record you will record in the same folder.

To	Do this
pause recording*	Press I/REC/PAUSE. During recording pause, the OPR indicator flashes in red and "PAUSE" flashes in the display window.
release pause and resume recording	Press I/REC/PAUSE. Recording resumes from that point. (To stop recording after pausing recording, press STOP.)
listen to the current	Press STOP to stop recording, then press recording. Press PLAY/STOP.
review the current recording instantly	Press PLAY/STOP during recording.
search backward during recording (Review)	Hold down LEFT during recording or recording pause. Recording mode will be released, and reviewing of the current recording starts. If you release the button, playback starts from that point.
select the microphone sensitivity	You can select the microphone sensitivity using the menu. See "Selecting the Microphone Sensitivity." H (high): To record at meeting or in a quiet and/or spacious place. L (low): To record for dictation or in a noisy place.

\* About one hour after you pause recording, recording pause is automatically released and the unit goes into the stop mode.

### Selecting the Folder

- Press DISPLAY/MENU for more than 1 second until "MODE" appears in the display window.
- Press LEFT or RIGHT to select "FOLDER" and press PLAY/STOP.
- Press LEFT or RIGHT to select the folder you want and press PLAY/STOP.
- Press STOP to exit the menu mode.



#### Note on recording

Noise may be recorded if an object, such as your finger, etc., accidentally rubs or scratches the unit during recording.

#### Maximum recording time

The maximum recording time of all the folders is as follows. You can record messages for the maximum recording time in a single folder.

HQ*	30 h. 25 min.
SP**	81 h. 15 min.
LP***	150 h. 15 min.

(h.: hours/min.: minutes)  
\* HQ: High quality recording mode (monaural sound)  
\*\* SP: Standard play recording mode (monaural sound)  
\*\*\*LP: Long play recording mode (monaural sound)

- #### Notes
- To record in better sound quality, select the HQ mode. For switching the recording mode, see "Changing the Recording Mode" on the reverse side.
  - Before making a long recording, be sure to check the battery indicator.
  - The maximum recording time and the number of messages you can make vary depending on the conditions of use.
  - When you record messages in the mixture of HQ, SP and LP mode, the maximum recording time will be between those of the HQ and LP modes.
  - Due to the limitation of the IC recording system, this unit records in the minimum recording unit of approx. 2 seconds at most, therefore the following symptoms may occur:
    - When a message is shorter than the minimum recording unit, it is still counted as approx. 2 seconds at most so the remaining recording time will decrease by more than the actual length of the message.
    - When the message is longer than the minimum recording unit, the remaining recording time will decrease by more than the actual length of the message if it cannot be divided by the minimum recording unit without a remainder.
    - The sum of the number on the counter (elapsed recording time) and the remaining recording time may be less than the unit's maximum recording time.

#### Remaining memory indication

During recording, the remaining memory indicator decreases one by one.

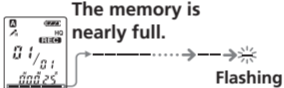

When the remaining time of recording reaches 5 minutes, the last one of the indication flashes. If the remaining recording time display mode is selected, "REMAIN" and the counter display flash when the remaining time reaches 1 minute. To continue recording, first erase some of the messages.

- #### Notes
- If you press I/REC/PAUSE when the memory is full, "FULL" will flash with an alarm sound. Erase some of the messages before you start recording again.
  - If you press I/REC/PAUSE after you have recorded 99 messages, "FULL" will flash with an alarm sound. Select another folder or erase some of the folders.

#### Starting recording automatically in response to the sound — Advanced VOR function

When VOR (voice operated recording) is set to "ON" in the menu, recording starts when the recorder detects sound. ("VOR" is displayed in the display window.)

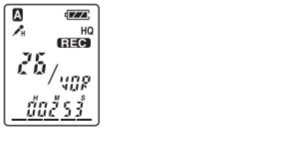

Recording stops when no sound is heard. ("VOR PAUSE" flashes in the display window.)

#### Note

VOR function is affected by the sound around you. Set the microphone sensitivity to "H (high)" or "L (low)" using the menu. If recording is not satisfactory after you have changed the microphone sensitivity, or for important recording, set VOR to "OFF."

### Selecting the Microphone Sensitivity

- Press DISPLAY/MENU for more than 1 second until "MODE" appears in the display window.
- Press LEFT or RIGHT to select "SENS" and press PLAY/STOP.
- Press LEFT or RIGHT to select "H (high sensitivity)" or "L (low sensitivity)" and press PLAY/STOP.
- Press STOP to exit the menu mode.

## Playing Back Messages

When playing back a previously recorded message, start from Step 1. When playing back a message you have just finished recording, start from Step 3.

### 1 Select the folder.

See "Selecting the Folder."

### 2 Select the message number.

Press LEFT or RIGHT to display the desired message number.

- LEFT: for smaller message number
- RIGHT: for larger message number

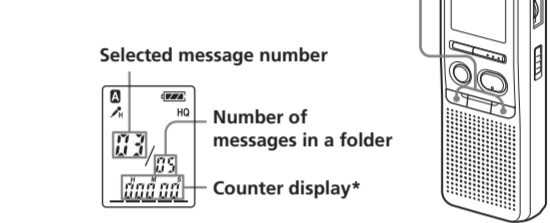

\* The display selected with the DISPLAY/MENU button appears (see the reverse side).

### 3 Start playback.

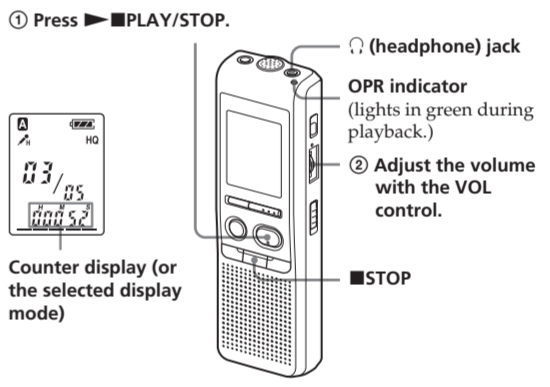

After playing back one message, the unit stops at the beginning of the next message. When the continuous play function is set to "ON" (see the reverse side), the unit stops after playing all messages in a folder. When the last message on a folder has been played back, the unit stops at the beginning of the last message.

#### For private listening

Connect an ear receiver or headphones (not supplied) to the (headphone) jack. The built-in speaker will be automatically disconnected. If noise is heard, wipe the headphones plug.

#### Other operations

To	Do this
stop at the current position	Press PLAY/STOP or STOP. To resume playback from that point, press PLAY/STOP again.
go back to the beginning of the current message	Press LEFT once.
skip to the next message	Press RIGHT once.
go back to previous messages/skip to succeeding messages	Press LEFT or RIGHT repeatedly. (During stop mode, keep the button pressed to skip the messages continuously.)

#### Playing back a message repeatedly

During playback, press PLAY/STOP for more than one second. " " will be displayed and the selected message will be played back repeatedly. To resume normal playback, press PLAY/STOP again. To stop playback, press STOP.

#### Playing back all messages in a folder continuously

#### Continuous Play

You can select the continuous play mode with "CONT" in the menu. When you set "CONT" to "ON," you can play back all messages in a folder continuously.

#### Searching forward/backward during playback (Cue/Review)

To search forward, keep RIGHT pressed during playback and release the button at the point you wish to resume playback. To search backward, keep LEFT pressed during playback and release the button at the point you wish to resume playback.

If you keep RIGHT or LEFT pressed, the unit starts to search at higher speed.

For the first 10 seconds of cue/review, fast playback sound can be heard. When searching at a higher speed, playback sound will not be heard. During cue/review, the counter will be displayed, regardless of the display mode setting.

☞ Tip When fast playback is done to the end of the last message, "END" flashes for 5 seconds. (You cannot hear the playback sound.) If you keep LEFT pressed while "END" is flashing, the messages are played back rapidly, and normal playback will start at the point you release the button. When "END" stops flashing and the OPR indicator goes off, the unit will stop at the beginning of the last message. If the last message is long and you wish to start playback at a later part of the message, keep RIGHT pressed to play back the message to the end and then press LEFT while "END" is flashing to go back to the desired point. (For messages other than the last one, go to the beginning of the next message and play backward to the desired point.)



# Erasing Messages

You can erase the recorded messages one by one or all messages in a folder at a time. Note that once a recording has been erased, you cannot retrieve it.

## Erasing messages one by one

When a message is erased, the remaining messages will advance and renumbered so that there will be no space between messages.

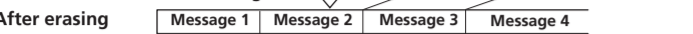
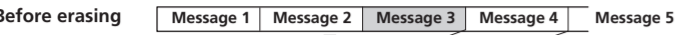

- Press ERASE while playing back the message you want to erase or press ERASE for more than 1 second during stop mode. A beep will sound and the message number and "ERASE" will flash while the whole message is played back 10 times.
- Press ERASE while the message is being played back. The message is erased and the remaining messages will be renumbered. (For example, if you erase Message 3, Message 4 will be renumbered as Message 3. When erasing is completed, the unit will stop at the beginning of the following message.)

**To cancel erasing**  
Press STOP before step ②.

**To erase other messages**  
Repeat steps ① and ②.

**To erase a message partially**  
First divide the message and then follow the steps to erase the message.

## Various Ways of Recording

### Adding a Recording to a Previously Recorded Message

You can add a recording to the message being played back. The added recording will be placed after the current message and counted as a part of the message.

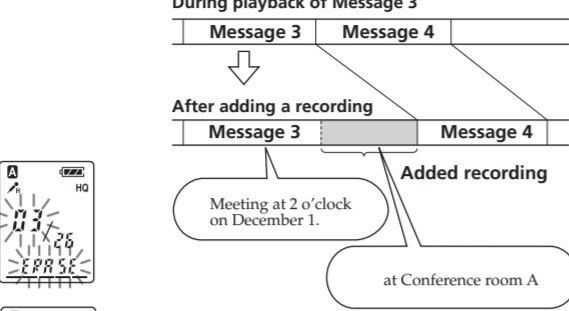

- During playback, press REC/PAUSE for more than 1 second. The "REC" indication appears and "ADD" will flash for 3 seconds in the display window. The OPR indicator will turn red. The new recording will be added at the end of the current message.
- Press STOP to stop the recording.

**Notes**

- You cannot add a recording if the remaining memory is not long enough.
- The added portion of a message will be recorded in the same recording mode (HQ, SP, or LP).

### Recording with an External Microphone or from Other Equipment

- Connect a plug-in-power type microphone or other equipment to the (microphone) jack.

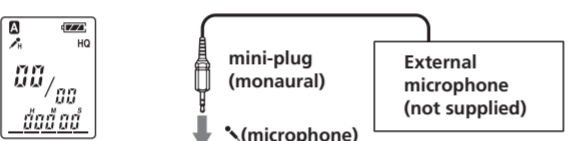

When you connect an external microphone, the built-in microphone is automatically cut off. When a plug in power type microphone is connected, power is automatically supplied to the microphone from the IC recorder.

### When recording from other equipment

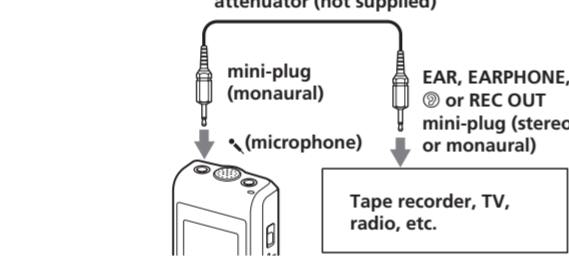

- Follow the steps in "Recording Messages" on the front side to record messages.

**Notes**

- Make sure that the plugs are connected securely.
- We recommend you make a trial recording to check the connections and volume control.
- When connecting equipment other than Sony's, refer to the instruction manual of the equipment.

### Starting Recording Automatically in Response to the Sound — Advanced VOR function

VOR ON: The VOR (Voice Operated Recording) function is activated. Recording starts when the unit detects sound and stops when no sound is heard, eliminating recording from soundless period.

VOR OFF: The VOR function is disabled. Normal recording operation is selected.

- Press DISPLAY/MENU for more than 1 second until "MODE" appears in the display window.
- Press  $\leftarrow$  or  $\rightarrow$  to display "VOR" and press PLAY/STOP. "OFF (or ON)" will flash.
- Press  $\leftarrow$  or  $\rightarrow$  to select "ON" or "OFF" and press PLAY/STOP. Now the setting is completed.
- Press STOP to exit the menu mode.

## Other Functions

### Dividing a Message

You can divide a message during recording or playback, so that the message is divided into two and the new message number is added to the divided message. By dividing a message, you can easily find the point you want to play back when you make a long recording such as a meeting. You can divide messages until the total number of messages in the folder becomes 99.

### While recording or playing back a message, press DIVIDE at the point you want to divide.

- When you press DIVIDE during recording:  
The new message number is added at the point you pressed the button, and the new message number and "DIVIDE" flash for 3 seconds. The message will be divided into two; however, the messages will be recorded without a break.

**Tip**  
You can divide a message during recording pause.

- When you press DIVIDE during playback:  
The message is divided into two at the point you pressed the button, and the new message number and "DIVIDE" flash for 3 seconds. The message numbers of the following messages will increase by one.

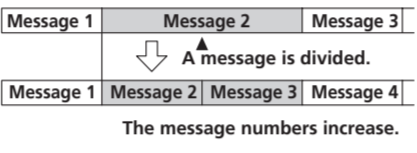

### To play the divided message

Press  $\leftarrow$  or  $\rightarrow$  to display the message number as the divided messages each have message numbers.

**Notes**

- If 99 messages have been recorded in a folder, you cannot divide a message. In that case, reduce the number of messages to 98 or less by erasing unnecessary messages or by moving some of the messages to another folder before dividing a message.
- If you divide a message with an alarm setting, the alarm setting remains only with the former message divided.

- You cannot divide a message in the first or the last 1 second.
- If you divide a message frequently, the unit may become unable to divide a message.
- Once a message is divided, you cannot combine the divided messages with the IC recorder.
- If you divide messages too frequently while the unit is recording them, the following phenomenon may occur: The OPR indicator keeps flashing, and you cannot operate the unit for a certain period. This is not a malfunction. Wait until the OPR indicator goes off.

### Moving Messages to a Different Folder — Move Function

You can move the recorded messages to another folder. Example: Moving Message 3 in Folder A to Folder C

- While the unit is stopped, select the message you want to move.
- Press DISPLAY/MENU for more than 1 second until "MODE" appears in the display window.
- Press  $\leftarrow$  or  $\rightarrow$  to select "MOVE" and press PLAY/STOP. The destination folder indication flashes.
- Press  $\leftarrow$  or  $\rightarrow$  to select the folder to which you want to move the message (C in this case).
- Press PLAY/STOP. The message is moved in the destination folder.
- Press STOP to exit the menu mode.

**To cancel moving the message(s)**  
Press STOP before step 5.

**Note**  
The move function does not duplicate a message in another folder. When you move a message to another folder, the one in the previous folder will be deleted.

### Playing Back a Message at a Desired Time with an Alarm

You can sound an alarm and start playback of a selected message at a desired time. If you select "B-ONLY" in Step 6, an alarm sounds only and playback will not start.

- Select the folder (See "Selecting the Folder" on the front side) and display the message you want to play back with an alarm.
- Enter the alarm setting mode.
  - Press DISPLAY/MENU for more than 1 second until "MODE" appears in the display window.
  - Press  $\leftarrow$  or  $\rightarrow$  to select "ALARM OFF" (If the alarm has already set to the selected message, "ALARM ON" is displayed. If you do not wish to change the setting, press STOP and exit the menu mode.)

**Note**  
"ALARM OFF (or ON)" will not appear and the alarm cannot be set if the clock has not been set or no message has been recorded in the selected folder.

- Press PLAY/STOP. "OFF" starts to flash.
- Press  $\leftarrow$  or  $\rightarrow$  to select "ON". "ON" starts to flash.
- Press PLAY/STOP. "DATE" will flash in the display window.

### Set the alarm date.

To play back on a desired date (the message will be played back at the same time on the same date every year until you erase the message)

- Press PLAY/STOP while "DATE" is flashing. The year digits will flash.
- Press  $\leftarrow$  or  $\rightarrow$  to select the year digits and press PLAY/STOP. The month digits will flash.
- Press  $\leftarrow$  or  $\rightarrow$  to select the month digits and press PLAY/STOP. The day digits will flash.
- Press  $\leftarrow$  or  $\rightarrow$  to select the day digits.

To play back once a week  
Press  $\leftarrow$  or  $\rightarrow$  to select the day of the week.

To play back at the same time every day  
Press  $\leftarrow$  or  $\rightarrow$  to select "DAILY."

- Set the alarm time.
  - Press  $\leftarrow$  or  $\rightarrow$  to select the hour digits and press PLAY/STOP. The minute digits will flash.
  - Press  $\leftarrow$  or  $\rightarrow$  to select the minute digits and press PLAY/STOP. "B-PLAY" will be displayed.
- Set the alarm sound.
  - Press  $\leftarrow$  or  $\rightarrow$  to select the alarm sound either from "B-PLAY" (playing back the message after the alarm) or "B-ONLY" (alarm only)
  - Press PLAY/STOP. "ALARM ON" will be displayed.
- Press STOP to exit the menu mode.

"\*" is displayed when the number of the message with alarm setting is selected. At the set time, the alarm will sound for about 10 seconds and the selected message will be played back. During playback, "ALARM" will flash in the display window. When the playback ends, the unit will stop automatically at the beginning of that message.

**To listen to the same message again**  
Press PLAY/STOP. The same message will be played back from the beginning.

### Turning off the Beep Sound

BEEP ON: A beep will sound to indicate that operation has been accepted.

BEEP OFF: No beep sound will be heard except for the alarm and timer.

- Press DISPLAY/MENU for more than 1 second until "MODE" appears in the display window.

- Press  $\leftarrow$  or  $\rightarrow$  to display "BEEP ON (or OFF)" and press PLAY/STOP. "ON (or OFF)" will flash.
- Press  $\leftarrow$  or  $\rightarrow$  to select "ON" or "OFF" and press PLAY/STOP. The setting is completed.

### Changing the Recording Mode

HQ: You can record with the high quality sound (monaural sound).

SP: You can record with better sound (monaural sound).

LP: You can record for longer time (monaural sound).

- Press DISPLAY/MENU for more than 1 second until "MODE" appears in the display window.
- Make sure that "MODE" is displayed and press PLAY/STOP. "HQ (or SP, LP)" will flash.

- Press  $\leftarrow$  or  $\rightarrow$  to select "ON" or "OFF" and press PLAY/STOP. Now the setting is completed.

### Preventing Accidental Operation — HOLD function

Slide the HOLD switch to "ON." "HOLD" will appear for 3 seconds, indicating that all the functions of the buttons are locked. When the HOLD function is activated during stop, all the display will be turned off after "HOLD" is displayed.

### To cancel the HOLD function

When the HOLD function is activated during recording, cancel the HOLD function first to stop recording.

**Tip**  
Even if the HOLD function is activated, you can stop the alarm playback. To stop the alarm or playback, press STOP.

### Selecting the Display Mode

You can select the display mode for the stop, recording and playback modes. Each time you press DISPLAY/MENU, the display mode will change as shown below:

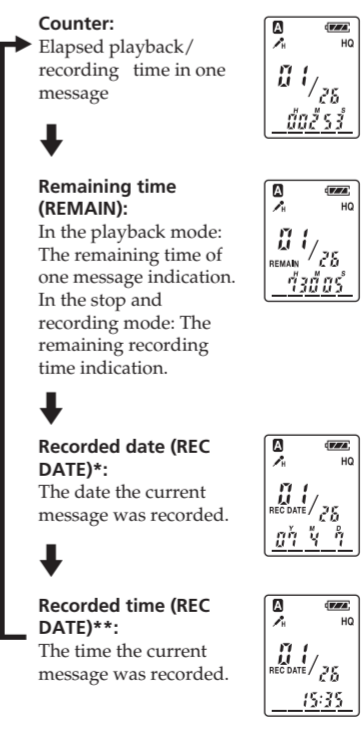

\* If the clock has not been set, "--Y--M--D" will be displayed.  
\*\* If the clock has not been set, "--:--" will be displayed.

## Precautions

- On power**
- Operate the unit only on 3 V DC. Use two LR03 (size AAA) alkaline batteries.
- On safety**
- Do not operate the unit while driving, cycling or operating any motorized vehicle.
- On handling**
- Do not leave the unit in a location near heat sources, or in a place subject to direct sunlight, excessive dust or mechanical shock.
  - Should any solid object or liquid fall into the unit, remove the batteries and have the unit checked by qualified personnel before operating it any further.
- On noise**
- Noise may be heard when the unit is placed near an AC power source, a fluorescent lamp or a mobile phone during recording or playback.
  - Noise may be recorded when an object, such as your finger, etc., rubs or scratches the unit during recording.
- On maintenance**
- To clean the exterior, use a soft cloth slightly moistened in water. Do not use alcohol, benzine or thinner.

If you have any questions or problems concerning your unit, please consult your nearest Sony dealer.

## Backup recommendations

To avoid potential risk of data loss caused by accidental operation or malfunction of the IC recorder, we recommend that you save a backup copy of your recorded messages on a tape recorder, etc.

## Specifications

- Recording media  
Built-in flash memory 256 MB, Monaural recording  
Actual usable capacity may be smaller.
- Recording time  
HQ: 30 hours 25 minutes  
SP: 81 hours 15 minutes  
LP: 150 hours 15 minutes
- Frequency range  
HQ: 260 Hz - 6,800 Hz  
SP: 220 Hz - 3,400 Hz  
LP: 220 Hz - 3,100 Hz
- Speaker  
approx. 2.8 cm (1 1/8 in.) dia.
- Power output  
250 mW
- Input/Output  
Headphone jack (minijack) for 8 - 300 ohms ear receiver/headphones  
Microphone jack (minijack, monaural)  
Plug in power  
Minimum input level 0.6 mV
- Power requirements  
Two LR03 (size AAA) alkaline batteries: 3 V DC
- Dimensions (w/h/d) (not incl. projecting parts and controls)  
34.6 × 109.5 × 18.0 mm (1 3/8 × 4 3/8 × 23/32 in.)
- Mass (incl. batteries)  
65 g (2.3 oz)
- Supplied accessories  
Operating instructions (1)  
LR03 (size AAA) alkaline batteries (2)  
Headphone (1) (excluding the U.S.A., Canada, Europe and Tourist model)  
Carrying pouch (1) (excluding the U.S.A., Canada, Europe and Tourist model)
- Optional accessories  
Electret Condenser Microphone ECM-DMSP, ECM-CZ10, ECM-TL1 (for telephone recording)  
Audio connecting cable RK-G64HG / RK-G69HG (excluding Europe)  
Active speaker SRS-T88, SRS-T80

Your dealer may not handle some of the above listed optional accessories. Please ask the dealer for detailed information.

Design and specifications are subject to change without notice.

## Erasing all messages in a folder

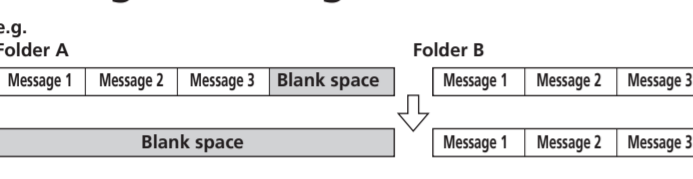

- Select the folder you want to erase using DISPLAY/MENU. (See "Selecting the Folder" on the front side.)

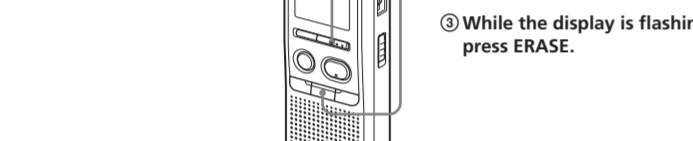

- While pressing STOP, press ERASE for more than 1 second. "ALL ERASE" will flash for 10 seconds.



- While the display is flashing, press ERASE.



**To cancel erasing**  
Press STOP before step ③.

# Index to Parts and Controls

