

One-Touch Wide-Conversion Lens

Operating Instructions

Mode d'emploi

Bedienungsanleitung

Manual de instrucciones

Gebruiksaanwijzing

Istruzioni per l'uso

Manual de instruções

Bruksanvisning

Инструкция по эксплуатации

AR

CT

KR

VCL-ES06A

© 2000 Sony Corporation Printed in Japan

1

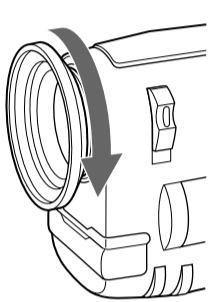

2

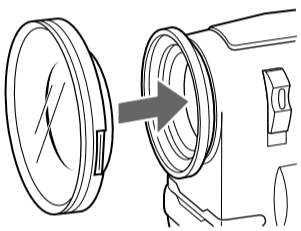

When removing

Retrait

Abnehmen

Al extraerlo

Verwijderen

Rimozione

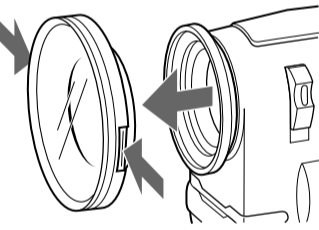

English

Before using this wide-conversion lens, please read this manual thoroughly and retain it for future reference.

The Sony VCL-ES06A wide-conversion lens is designed for use with the Sony video camera recorder and digital still camera. The lens reduces the focal length of the zoom lens by 0.6 times and allows a wider view. Attachment of this lens to the video camera recorder has no effect on light transmission nor on the sharpness of focus.

Notes on use

- Set the video camera to W (maximum width/widest point). This lens can only be used when set to W (widest). It will be out of focus if set to T (telescopic).
- Avoid rough handling or mechanical shock to the video camera recorder, especially when the lens is attached.
- Avoid keeping the lens in a very hot or humid place for a long period of time to prevent mold.
- Take the conversion lens off when transporting.
- Always attach the lens caps when storing.

Attachment (See illustrations)

The size is marked on the accessory adapter.

When the lens hood of the video camera recorder is detachable, first remove the lens hood.

- Install an adapter marked with the same size as the lens. → **1**
- Remove the caps of wide-conversion lens.
- Attach the wide-conversion lens firmly to the adaptor attached to the video camera recorder. → **2**

Focusing

- Focus with the video camera recorder's focus ring by watching the viewfinder or monitor screen.
- Use manual focus if it proves difficult to focus some video cameras having an auto focus function.

Notes on focusing

- Focus the video camera manually when using the PROGRAM AE function. If you set focus to AUTO mode, focus may not be clear.
- If you set focus to infinity mode, focus is unclear.

Cleaning

To remove dust on the lens, use a blower brush or a soft cleaning brush.

To remove fingerprints or smudges, clean with mild detergent and a soft cloth.

Specifications

Magnification	0.6 ×
Dimensions	Maximum diameter Approx. ø 75 mm (3 inch), Length Approx. 20.5 mm (¹³ / ₁₆ inch)
Mass (excluding the caps and adaptors)	Approx. 80 g
Supplied accessories	Lens caps (2) (for the front and back of the lens), Carrying Pouch (1), Instruction manual (1), Adaptors (3: 30 mm (1 ⁹ / ₁₆ inch), 37 mm (1 ¹ / ₂ inch), 52 mm (2 ¹ / ₈ inch))

Design and specifications are subject to change without notice.

	This mark indicates that this product is a genuine accessory for Sony video products. When purchasing Sony video products, Sony recommends that you purchase accessories with this "GENUINE VIDEO ACCESSORIES" mark.
--	--

Français

Avant d'utiliser cet objectif, veuillez lire attentivement ce mode d'emploi et le conserver pour toute référence ultérieure.

L'objectif de conversion grand angle Sony VCL-ES06A a été conçu pour les caméscopes et les appareils photo numériques Sony. L'objectif réduit la longueur focale du zoom de 0,6 fois et permet d'obtenir une vue plus large. Le fait de fixer cet objectif sur le caméscope n'a aucun effet sur la transmission de la lumière, ni sur la mise au point.

Remarques sur l'utilisation

- Réglez le caméscope sur W (largeur maximale/grand angle). Cet objectif peut être utilisé seulement avec le réglage effectué sur W (position grand angle). La mise au point ne sera pas correcte si le réglage est effectué sur T (téléobjectif).
- Évitez d'exposer le caméscope à des manipulations brusques ou des chocs mécaniques, en particulier lorsque l'objectif est en place.
- Évitez de laisser l'objectif dans des endroits très chauds ou très humides, afin d'éviter les moisissures.
- Avant de transporter le caméscope, enlevez l'objectif de conversion.
- Laissez toujours les capuchons d'objectif en place quand vous n'utilisez pas l'objectif.

Fixation (voir les illustrations)

Le format est inscrit sur l'adaptateur d'accessoires. Si le pare-soleil du caméscope est amovible, ôtez-le d'abord.

- Installez un adaptateur dont le format est le même que celui de l'objectif. → **1**
- Otez les capuchons de l'objectif de conversion grand angle.
- Fixez fermement l'objectif de téléconversion sur l'adaptateur fixé au caméscope. → **2**

Mise au point

- Faites la mise au point à l'aide de la bague de mise au point du caméscope en regardant dans le viseur ou l'écran du moniteur.
- Faites la mise au point manuelle si vous n'arrivez pas à la faire sur certains caméscopes avec autofocus.

Remarques sur la mise au point

- Faites la mise au point de votre caméscope manuellement lorsque vous utilisez la fonction PROGRAM AE. Si vous réglez la mise au point sur AUTO, elle n'est pas nette.
- Si vous réglez la mise au point sur infini, elle n'est pas nette.

Nettoyage

Pour dépeussierér l'objectif, utilisez un pinceau soufflant ou une brosse douce. Les traces de doigt et les taches rebelles s'enlèvent avec un chiffon doux imbibé d'une solution savonneuse neutre.

Spécifications

Puissance de l'objectif	0,6 ×
Dimensions	Diamètre maximal : env. ø 75 mm (3 inch), longueur : env. 20.5 mm (¹³ / ₁₆ inch)
Poids (sans les capuchons ni les adaptateurs)	Env. 80 g
Accessoires fournis	Capuchons (2) (pour l'avant et l'arrière de l'objectif), étui de transport (1), mode d'emploi (1), adaptateurs (3: 30 mm (1 ⁹ / ₁₆ inch), 37 mm (1 ¹ / ₂ inch), 52 mm (2 ¹ / ₈ inch))

La conception et les spécifications peuvent être modifiées sans préavis.

	GENUINE VIDEO ACCESSORIES <p>Ce logo indique qu'il s'agit d'un accessoire d'origine pour le matériel vidéo Sony. Lorsque vous achetez des produits vidéo Sony, Sony vous conseille de vous procurer les accessoires portant aussi ce logo.</p>
---	--

Deutsch

Lesen Sie diese Anleitung vor Inbetriebnahme des Weitwinkelkonverters bitte genau durch, und bewahren Sie sie zum späteren Nachschlagen sorgfältig auf.

Der Weitwinkelkonverter VCL-ES06A ist für Videokameras und digitale Standbildkameras von Sony konzipiert. Durch den Konverter verringert sich die Brennweite des Zoom-Objektivs um das 0,6fache, und es läßt sich ein breiterer Bildausschnitt erfassen.

Der Konverter hat bei einer Videokamera keinen Einfluß auf die Menge des einfallenden Lichts oder die Fokussierung.

Hinweise zur Verwendung

- Stellen Sie an der Videokamera die Position W (maximaler Weitwinkelbereich) ein. Der Konverter kann nur verwendet werden, wenn an der Kamera die Position W (maximaler Weitwinkelbereich) eingestellt ist. Wenn an der Kamera die Positlon T (Telebereich) eingestellt ist, läßt sich das Bild nicht scharfstellen.
- Behandeln Sie die Videokamera pfleglich, und schützen Sie sie vor Stößen, besonders, wenn der Konverter angebracht ist.
- Bewahren Sie den Konverter nicht längere Zeit an einem heißen oder feuchten Ort auf, da es andernfalls zu Schimmelbildung kommen kann.
- Nehmen Sie den Konverter ab, wenn Sie die Kamera transportieren wollen.
- Bringen Sie immer die Objektivschutzkappe an, wenn Sie den Konverter längere Zeit nicht verwenden.

Anbringen des Konverters (siehe Abbildungen)

Die Größe ist auf dem Zubehöradapter angegeben.

Wenn die Gegenlichtblende der Videokamera abgenommen werden kann, nehmen Sie zunächst die Gegenlichtblende ab.

- Bringen Sie einen Adapter derselben Größe wie der Konverter an. → **1**
- Nehmen Sie die Kappen des Weitwinkelkonverters ab.
- Bringen Sie den Weitwinkelkonverter fest am Adapter an der Videokamera an. → **2**

Fokussieren

- Stellen Sie das Bild im Sucher oder auf dem Monitorbildschirm mit dem Fokussierring der Videokamera scharf.
- Bei manchen Kameras mit Autofokus läßt sich das Bild unter Umständen nur schwer scharfstellen. Stellen Sie in diesem Fall den Fokus manuell ein.

Hinweise zum Fokussieren

- Stellen Sie den Fokus an der Videokamera manuell ein, wenn Sie die Funktion PROGRAM AE verwenden. Wenn der Fokus auf AUTO eingestellt ist, läßt sich das Bild möglicherweise nicht scharfstellen.
- Wenn Sie die Unendlicheinstellung wählen, läßt sich das Bild nicht scharfstellen.

Reinigung

Entfernen Sie Staub mit einem Staubbäler oder einem weichen Reinigungspinsel vom Konverter.

Fingerabdrücke oder sonstige Verschmutzungen entfernen Sie mit einem milden Reinigungsmittel und einem weichen Tuch.

Technische Daten

Vergroößerung	0,6 ×
Abmessungen	Maximaler Durchmesser ca. ø 75 mm, Länge ca. 20.5 mm
Gewicht (ohne Kappen und Adapter)	ca. 80 g
Mitgeliefertes Zubehör	Objektivschutzkappen (2) (für die Vorder- und die Rückseite des Konverters), Tragebeutel (1), Bedienungsanleitung (1), Adapter (3: 30 mm, 37 mm, 52 mm)

Änderungen, die dem technischen Fortschritt dienen, bleiben vorbehalten.

	Dieses Logo zeigt an, dass es sich bei diesem Produkt um Originalzubehör für Videogeräte von Sony handelt. Wenn Sie Videogeräte von Sony erwerben, achten Sie bitte auch beim Kauf von Zusatzkomponenten und -geräten darauf, daß sie mit dem Logo "GENUINE VIDEO ACCESSORIES" gekennzeichnet sind.
---	---

Español

Antes de utilizar este objetivo de conversión panorámica, lea este manual atentamente y consérvelo para consultarlo en el futuro.

El objetivo de conversión panorámica Sony VCL-ES06A está diseñado para utilizarse con videocámaras y cámaras digitales de imagen fija Sony. El objetivo reduce la distancia focal del objetivo zoom en 0,6 veces y permite obtener vistas más amplias. La instalación de este objetivo en la videocámara no tendrá efecto en la transmisión de la luz ni en la nitidez del enfoque.

Notas sobre la utilización

- Ajuste la videocámara en W (anchura máxima/punto más amplio). Este objetivo sólo puede utilizarse cuando está ajustado en W (valor más amplio). Se desenfocará si se ajusta en T (telescopico).
- Evite manejar con rudeza la videocámara, y golpearla, especialmente cuando le instale el objetivo.
- Evite guardar el objetivo en un lugar muy cálido o húmedo durante mucho tiempo a fin de evitar la formación de moho.
- Antes de transportar la videocámara, quitele el objetivo de conversión.
- Antes de guardar el objetivo, colóquele las tapas.

Instalación (Consulte las ilustraciones)

- El tamaño está marcado en el adaptador para accesorios. Cuando el pararas de la videocámara sea desmontable, quiteelo en primer lugar.
- Instale un adaptador marcado con el mismo tamaño que el del objetivo. → **1**
 - Extraiga las tapas del objetivo de conversión panorámica.
 - Fije el objetivo de conversión panorámica firmemente al adaptador instalado en la videocámara. → **2**

Enfoque

- Enfoque con el anillo de enfoque de la videocámara observando el visor o la pantalla del monitor.
- Si es difícil enfocar con algunas videocámaras con función de enfoque automático, utilice el enfoque manual.

Notas sobre el enfoque

- Realice el enfoque de la videocámara manualmente cuando utilice la función PROGRAM AE. Si ajusta el enfoque en AUTO, puede no ser nítido.
- Si ajusta el enfoque en el modo infinito, dicho enfoque no será nítido.

Limpeiza

Para limpiar el polvo del objetivo, utilice un cepillo soplador o un cepillo limpiador suave.

Para eliminar las huellas dactilares o las manchas, utilice un paño suave humedecido en una solución poco concentrada de detergente.

Especificaciones

Ampliación	0,6 ×
Dimensiones	Díametro máximo aprox. ø 75 mm (3 pulgadas), Longitud aprox. 20.5 mm (¹³ / ₁₆ pulgadas)
Peso (excluyendo las tapas y los adaptadores)	Aprox. 80 g
Accesorios suministrados	Tapas para objetivo (2) (para las partes frontal y posterior del objetivo), Bolsa de transporte (1), Manual de instrucciones (1), Adaptadores (3: 30 mm (1 ⁹ / ₁₆ pulgadas), 37 mm (1 ¹ / ₂ pulgadas),52 mm (2 ¹ / ₈ pulgadas))

El diseño y las especificaciones están sujetos a cambio sin previo aviso.

	Esta marca indica que este producto es un accesorio genuino para productos de vídeo Sony. Cuando adquiera productos de vídeo Sony, Sony recomienda que adquiera los que lleven la marca "GENUINE VIDEO ACCESORIES".
---	---

Nederlands

Voordat u deze groothoeklens in gebruik neemt, moet u deze gebruiksaanwijzing aandachtig lezen en bewaren zodat u ze later nog kunt raadplegen.

De Sony VCL-ES06A telelens is ontworpen voor gebruik met een Sony camcorder en digitale camera. De lens beperkt de brandpuntsafstand van de zoomlens met 0,6 keer en biedt een bredere kijkhoek. Het bevestigen van deze lens op de camcorder heeft geen invloed op de lichtdoorlaat noch de scherpstelling.

Opmerkingen bij het gebruik

- Zet de camcorder op W (maximum breedte/breedste punt). Deze lens kan alleen worden gebruikt in de stand W (breed). In de stand T (tele) is het beeld onscherp.
- Stel de camcorder niet bloot aan ruwe behandeling noch schokken, vooral wanneer de lens is bevestigd.
- Bewaar de lens niet gedurende lange tijd op een zeer warme of vochtige plaats om schimmelvorming te vermijden.
- Verwijder de lens tijdens het transport.
- Bevestig altijd de lenskap wanneer u de lens niet gebruikt.

Bevestiging (zie illustraties)

De maat is aangegeven op de accessoire-adapter.

Verwijder eerst de lenskap van de camcorder wanneer die kan worden verwijderd.

- Monteer een adapter met dezelfde maat als de lens. → **1**
- Haal de kappen van de groothoeklens.
- Bevestig de groothoeklens stevig op de adapter op de camcorder. → **2**

Scherpstelling

- Stel scherp met de scherpstelring van de camcorder in de beeldzoeker of naar het monitorscherm te kijken.
- Stel handmatig scherp wanneer u problemen ondervindt bij het automatisch scherpstellen.

Opmerkingen bij het scherpstellen

- Stel handmatig scherp bij gebruik van de PROGRAM AE functie. In de stand AUTO kan niet goed worden scherpgesteld.
- Indien u op oneindig scherpstelt, kan het beeld onscherp zijn.

Reiniging

Verwijder stof van de lens met behulp van een blaasborstel of een zachte reinigingsborstel.

Verwijder vingerafdrukken en vuil met een mild zeepsopje en een zachte doek.

Technische gegevens

Lensvermogen	0,6 ×
Afmetingen	Maximum diameter ong. ø 75 mm, lengte ong. 20,5 mm
Gewicht (zonder kappen en adapters)	Ong. 80 g
Meegeleverde toebehoren	Lenskappen (2) (voor de voorkant en de achterkant van de lens), draagtas (1), gebruiksaanwijzing (1), adapter (3: 30 mm, 37 mm, 52 mm)

Wijzigingen in ontwerp en technische gegevens voorbehouden zonder voorafgaande kennisgeving.

	Deze aanduiding kenmerkt dit product als een originele accessoire voor Sony videoapparatuur. Het is aanbevolen voor Sony videoapparatuur uitsluitend de originele accessoires aan te schaffen, die zijn voorzien van dit "GENUINE VIDEO ACCESSORIES" beeldmerk.
--	---

Italiano

Prima di utilizzare questo obiettivo ad ampia conversione, leggere attentamente il presente manuale e conservarlo per riferimenti futuri.

L'obiettivo ad ampia conversione VCL-ES06A Sony è stato progettato per essere utilizzato con una videocamera e con una macchina fotografica ferma digitale Sony. L'obiettivo riduce di 0,6 volte la lunghezza focale dell'obiettivo a focale variabile, fornendo così una visione più ampia. L'inserimento dell'obiettivo nella videocamera non ha alcun effetto sulla trasmissione della luce né sulla nitidezza della messa a fuoco.

Note sull'utilizzo

- Impostare la videocamera su W (punto massimo di ampiezza). Questo obiettivo, infatti, può essere utilizzato solo se è impostato su W (ampiezza massima). Se viene impostato su T (telescopico), l'immagine apparirà sfuocata.
- Maneggiare con cura la videocamera ed evitare di sottoporla ad urti, specialmente quando è inserito l'obiettivo.
- Non lasciare l'obiettivo in luoghi esposti a calore o umidità eccessivi per periodi di tempo prolungati, onde evitare eventuali formazioni di muffa.
- Rimuovere l'obiettivo dalla videocamera durante il trasporto.
- Applicare sempre il copriobiettivo quando l'obiettivo non è in uso.

Installazione (vedere l'illustrazione)

La dimensione è indicata sull'adattatore accessorio.

Rimuovere prima il copriobiettivo se è estraibile.

- Installare un adattatore della stessa dimensione dell'obiettivo. → **1**
- Rimuovere i cappucci di protezione dell'obiettivo ad ampia conversione.
- Inserire saldamente l'obiettivo ad ampia conversione nell'adattatore collegato alla videocamera. → **2**

Messa a fuoco

- Per la messa a fuoco, utilizzare il regolatore di focalizzazione della videocamera e osservare l'immagine nel mirino o sullo schermo del monitor.
- Utilizzare la messa a fuoco manuale se la focalizzazione risulta difficile con videocamere che dispongono della funzione di messa a fuoco automatica.

Note sulla messa a fuoco

- Utilizzare la messa a fuoco manuale quando è attivata la funzione PROGRAM AE. La messa a fuoco potrebbe risultare non chiara se è stata impostata su AUTO.
- La messa a fuoco potrebbe risultare non chiara se è stata impostata sul modo infinito.

Pulizia

Per eliminare la polvere dall'obiettivo, utilizzare un soffietto o una spazzola di pulizia morbida. Per eliminare impronte o altre macchie, utilizzare un detergente delicato e un panno morbido.

Caratteristiche tecniche

Ingrandimento	0,6 ×
Dimensioni	Diametro massimo circa 75 mm, lunghezza circa 20,5 mm
Peso (esclusi i copriobiettivi e gli adattatori)	Circa 80 g
Accessori in dotazione	Copriobiettivi (2) (per la parte anteriore e posteriore dell'obiettivo), Custodia per il trasporto (1), manuale per il funzionamento (1), adattatore (3: 30 mm, 37 mm, 52 mm)

Il design e caratteristiche tecniche sono soggetti a modifiche senza preavviso.

	Questo contrassegno indica che si tratta di un prodotto video originale Sony. Quando si acquistano prodotti video Sony, Sony consiglia di acquistare accessori con questo contrassegno "GENUINE VIDEO ACCESSORIES".
---	---

Sony online <http://www.world.sony.com/>

Printed on recycled paper

1

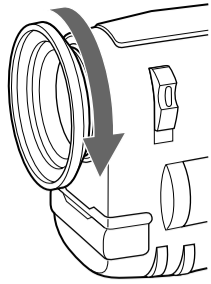

2

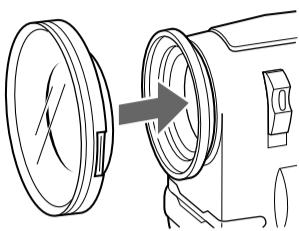

Quando retirar Ta bort**При удалении****When removing****When removing****When removing**

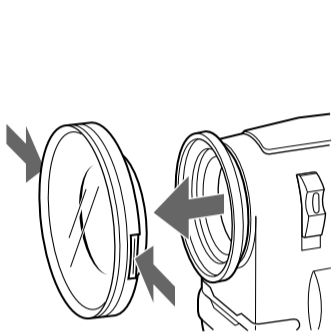

Português

Antes de utilizar a lente de conversão grande angular, leia este manual até ao fim e guarde-o para consulta futura.

A lente de conversão grande-angular VCL-ES06A da Sony destina-se a ser utilizada com as câmaras de vídeo e com as máquinas fotográficas digitais da Sony. A objectiva reduz a distância focal da lente de zoom em cerca de 0,6 vezes e permite uma visualização mais ampla.

A montagem desta lente na câmara de vídeo não tem efeitos sobre a transmissão da luz ou a nitidez de focagem.

Notas sobre a utilização

- Regule a câmara de vídeo para W (ponto máximo de grande angular). Esta lente só pode ser utilizada se estiver regulada para W (grande angular). Se a regular para T (teleobjectiva) fica desfocada.
- Manuseie a câmara com cuidado e não a exponha a choques fortes, sobretudo com a lente montada.
- Evite guardar a lente durante muito tempo, num local muito quente ou húmido, para evitar o bolor.
- Quando transportar a câmara retire a lente de conversão grande angular.
- Não guarde a lente sem colocar a tampa respectiva.

Montagem (Consulte as figuras)

O tamanho está indicado no adaptador do acessório.

Se a tampa da lente da câmara de vídeo for amovível, retire-a primeiro.

- Monte um adaptador cuja marca tenha um tamanho igual ao da lente. → **1**
- Retire as tampas da lente de conversão grande angular.
- Monte bem a lente de conversão grande angular no adaptador instalado na câmara de vídeo. → **2**

Focagem

- Foque utilizando o anel de focagem da câmara de vídeo olhando para o visor electrónico ou o ecrã do monitor.
- Utilize a focagem manual se tiver dificuldades de focagem nalgumas câmaras de vídeo equipadas com a função de focagem manual.

Notas sobre a focagem

- Quando utilizar a função PROGRAM AE, faça a focagem manualmente. Se regular a focagem para AUTO, esta pode não ficar nítida.
- Se regular a focagem para o modo infinito, esta não fica nítida.

Limpeza

Para limpar o pó da lente, utilize a escova de um soprador ou uma escova de limpeza macia.

Para retirar as dedadas ou manchas, limpe com um detergente suave e um pano macio.

Características técnicas

Aumento	0,6 ×
Dimensões	Diâmetro máximo Aprox. ø 75 mm (3 polegadas), Comprimento aprox. 20.5 mm (¹³ ⁄ ₁₆ polegadas)
Peso (excluindo as tampas e os adaptadores)	Aprox. 80 g
Acessórios fornecidos	Lente da objectiva (2) (para a parte da frente e a parte de trás da lente), Estojo de transporte (1), Manual de instruções (1), Adaptadores (3: 30 mm (1 ⁹ ⁄ ₁₆ polegadas), 37 mm (1 ¹ ⁄ ₂ polegadas), 52 mm (2 ¹ ⁄ ₈ polegadas))

Design e características técnicas sujeitas a alterações sem aviso prévio.

	Esta marca indica que este produto é um acessório genuíno para produtos de vídeo da Sony. Quando adquirir produtos de vídeo da Sony, deve adquirir acessórios com a marca "GENUINE VIDEO ACCESSORIES".
---	--

Svenska

Innan du använder det här vidvinkelobjektivet bör du läsa igenom handledningen noga och sedan spara den för framtida bruk.

Sonys vidvinkelobjektiv VCL-ES06A är konstruerat för Sonys videokameror och digitala stillbildskameror. Objektivet reducerar zoomobjektivets brännvidd 0,6 gånger och skapar ett bredare synfält. När du fäster det här objektivet på kameran påverkar du vare sig ljusflöde eller fokusering.

Användning

- Ställ videokameran på W (maximal vidd/vidvinkel). Det här objektivet kan bara användas i läget W (vidvinkel). I läget T (tele) hamnar det ur fokus.
- Hantera objektivet varsamt och undvik att utsätta kameran för stötar, särskilt när objektivet är monterat på den.
- Undvik att förvara objektivet någon längre tid där det är varmt och fuktigt, så undviker du mögelbildning.
- Ta bort objektivet under transporter.
- Förvara alltid objektivet med linsskyddet monterat.

Montering (se illustrationerna)

Storleken är markerad på tillbehörsadaptern.

Om kamerans motljusskydd är löstagbart, bör du först ta bort det.

- Montera en adapter som är märkt med samma storlek som objektivet. → **1**
- Ta av skyddslocken på vidvinkelobjektivet.
- Fäst teleobjektivet ordentligt på den adapter som är fäst på videokameran. → **2**

Fokusering

- Fokusera genom att vrida på kamerans fokuseringsring, samtidigt som du granskar bilden i sökaren eller på TV-skärmen.
- På vissa videokameror kan det vara svårt att få den automatiska fokuseringen att fungera. I så fall ställer du in skärpan manuellt.

Om fokusering

- Om du använder funktionen PROGRAM AE bör du utföra skärpeinställningen manuellt. Om du ställer fokuseringen på AUTO kan det hända att du inte får fullgod skärpa.
- Om du ställer fokus på oändligheten får du ingen skärpa.

Rengöring

Blås bort damm från objektivet med en bläsborste eller en mjuk linsborste. Om du behöver torka bort fingeravtryck eller fastsittande smuts, kan du använda ett mildt rengöringsmedel och en mjuk duk.

Specificationer

Förstoring	0,6 ×
Mått	Max diameter ca. ø 75 mm, längd ca. 20.5 mm
Vikt (utan skyddslock och adapterar)	ca. 80 g
Medföljande tillbehör	Skyddslock (2) (för objektivets fram- och baksida), Bärvärska (1), Bruksanvisning (1), Adapter (3: 30 mm, 37 mm, 52 mm)

Rätt till ändring av mått och specifikationer förbehålles.

	Det här märket visar att produkten är ett originaltillbehör till Sonys videoprodukter. Du rekommenderas att alltid köpa tillbehör som är märkta med det här märket, "GENUINE VIDEO ACCESSORIES".
---	--

Русский язык

Перед использованием этого широкоугольного объектива внимательно прочтите, пожалуйста, данное руководство и сохраните его для дальнейших справок.

Широкоугольный телеобъектив Sony VCL-ES06A предназначен для использования с видеокамерой или цифровой фотокамерой Sony. Этот объектив в 0,6 раза уменьшает фокусное расстояние трансфокатора и обеспечивает более широкий угол обзора.

Присоединение этого объектива к видеокамере не влияет ни на передачу света, ни на четкость фокусировки.

Примечания по использованию

- Переведите видеокамеру в режим W (максимальной ширины/самого широкого угла обзора). Этот объектив можно использовать только в режиме W (максимальная ширина). Если установлен режим T (выдвижной объектив), фокусировка будет неправильной.
- Не допускайте грубого обращения с видеокамерой или механических ударов по ней, особенно, когда прикреплен этот объектив.
- Не оставляйте этот объектив на длительное время в местах с повышенной температурой или влажностью во избежание появления плесени.
- При транспортировке этот объектив следует снять.
- При хранении обязательно закрывайте объектив крышкой.

Прикрепление (см. рисунки)

Размер указан на адаптере дополнительных устройств.

Если бленда объектива на видеокамере съёмная, сначала снимите бленду.

- Установите адаптер, соответствующий размеру объектива. → **1**
- Снимите крышки широкоугольного объектива.
- Аккуратно присоедините широкоугольный объектив к адаптеру, закреплённому на видеокамере. → **2**

Фокусировка

- Выполните фокусировку с помощью кольца фокусировки видеокамеры, глядя в видоискатель или на экран монитора.
- Поскольку фокусировка на некоторых камерах с функцией автоматической фокусировки затруднена, используйте ручную фокусировку.

Замечания по фокусировке

- При использовании функции PROGRAM AE выполняйте фокусировку видеокамеры вручную. Если для фокусировки установлен режим AUTO, фокусировка может быть нечеткой.
- Если установлен режим бесконечного фокуса, фокусировка будет нечеткой.

Чистка

Для удаления пыли с объектива используйте щетку пылесоса или мягкую щетку для чистки.

Для удаления отпечатков пальцев или пятен используйте слабый раствор моющего средства и мягкую ткань.

Технические характеристики

Оптическая сила объектива	0,6 ×
Размеры	Максимальный диаметр прибл. ø 75 мм, длина прибл. 20.5 мм
Масса (без крышек и адаптеров)	Прибл. 80 г
Прилагаемые принадлежности	Крышки объектива (2) (для передней и задней стороны объектива), футляр для переноски (1), руководство по эксплуатации (1), адаптер (3: 30 мм, 37 мм, 52 мм)

Конструкция и технические характеристики могут изменяться без предварительного уведомления.

	Данная метка означает, что это изделие является подлинной принадлежностью для видеоаппаратуры Sony. При покупке видеоаппаратуры Sony рекомендуется приобретать для нее принадлежности Sony с меткой "GENUINE VIDEO ACCESSORIES".
---	--

AR

Before using this wide-conversion lens, please read this manual thoroughly and retain it for future reference.

The Sony VCL-ES06A wide-conversion lens is designed for use with the Sony video camera recorder and digital still camera. The lens reduces the focal length of the zoom lens by 0.6 times and allows a wider view. Attachment of this lens to the video camera recorder has no effect on light transmission nor on the sharpness of focus.

Notes on use

- Set the video camera to W (maximum width/widest point). This lens can only be used when set to W (widest). It will be out of focus if set to T (telescopic).
- Avoid rough handling or mechanical shock to the video camera recorder, especially when the lens is attached.
- Avoid keeping the lens in a very hot or humid place for a long period of time to prevent mold.
- Take the conversion lens off when transporting.
- Always attach the lens caps when storing.

Attachment (See illustrations)

The size is marked on the accessory adapter.

When the lens hood of the video camera recorder is detachable, first remove the lens hood.

- Install an adapter marked with the same size as the lens. → **1**
- Remove the caps of wide-conversion lens.
- Attach the wide-conversion lens firmly to the adaptor attached to the video camera recorder. → **2**

Focusing

- Focus with the video camera recorder’s focus ring by watching the viewfinder or monitor screen.
- Use manual focus if it proves difficult to focus some video cameras having an auto focus function.

Notes on focusing

- Focus the video camera manually when using the PROGRAM AE function. If you set focus to AUTO mode, focus may not be clear.
- If you set focus to infinity mode, focus is unclear.

Cleaning

To remove dust on the lens, use a blower brush or a soft cleaning brush. To remove fingerprints or smudges, clean with mild detergent and a soft cloth.

Specifications

Magnification	0.6 ×
Dimensions	Maximum diameter Approx. ø 75 mm (3 inch), Length Approx. 20.5 mm (¹³ ⁄ ₁₆ inch)
Mass (excluding the caps and adaptors)	Approx. 80 g
Supplied accessories	Lens caps (2) (for the front and back of the lens), Carrying Pouch (1), Instruction manual (1), Adaptors (3: 30 mm (1 ⁹ ⁄ ₁₆ inch), 37 mm (1 ¹ ⁄ ₂ inch), 52 mm (2 ¹ ⁄ ₈ inch))

Design and specifications are subject to change without notice.

	This mark indicates that this product is a genuine accessory for Sony video products. When purchasing Sony video products, Sony recommends that you purchase accessories with this "GENUINE VIDEO ACCESSORIES" mark.
---	--

CT

Before using this wide-conversion lens, please read this manual thoroughly and retain it for future reference.

The Sony VCL-ES06A wide-conversion lens is designed for use with the Sony video camera recorder and digital still camera. The lens reduces the focal length of the zoom lens by 0.6 times and allows a wider view. Attachment of this lens to the video camera recorder has no effect on light transmission nor on the sharpness of focus.

Notes on use

- Set the video camera to W (maximum width/widest point). This lens can only be used when set to W (widest). It will be out of focus if set to T (telescopic).
- Avoid rough handling or mechanical shock to the video camera recorder, especially when the lens is attached.
- Avoid keeping the lens in a very hot or humid place for a long period of time to prevent mold.
- Take the conversion lens off when transporting.
- Always attach the lens caps when storing.

Attachment (See illustrations)

The size is marked on the accessory adapter.

When the lens hood of the video camera recorder is detachable, first remove the lens hood.

- Install an adapter marked with the same size as the lens. → **1**
- Remove the caps of wide-conversion lens.
- Attach the wide-conversion lens firmly to the adaptor attached to the video camera recorder. → **2**

Focusing

- Focus with the video camera recorder’s focus ring by watching the viewfinder or monitor screen.
- Use manual focus if it proves difficult to focus some video cameras having an auto focus function.

Notes on focusing

- Focus the video camera manually when using the PROGRAM AE function. If you set focus to AUTO mode, focus may not be clear.
- If you set focus to infinity mode, focus is unclear.

Cleaning

To remove dust on the lens, use a blower brush or a soft cleaning brush. To remove fingerprints or smudges, clean with mild detergent and a soft cloth.

Specifications

Magnification	0.6 ×
Dimensions	Maximum diameter Approx. ø 75 mm (3 inch), Length Approx. 20.5 mm (¹³ ⁄ ₁₆ inch)
Mass (excluding the caps and adaptors)	Approx. 80 g
Supplied accessories	Lens caps (2) (for the front and back of the lens), Carrying Pouch (1), Instruction manual (1), Adaptors (3: 30 mm (1 ⁹ ⁄ ₁₆ inch), 37 mm (1 ¹ ⁄ ₂ inch), 52 mm (2 ¹ ⁄ ₈ inch))

Design and specifications are subject to change without notice.

	This mark indicates that this product is a genuine accessory for Sony video products. When purchasing Sony video products, Sony recommends that you purchase accessories with this "GENUINE VIDEO ACCESSORIES" mark.
--	--

KR

Before using this wide-conversion lens, please read this manual thoroughly and retain it for future reference.

The Sony VCL-ES06A wide-conversion lens is designed for use with the Sony video camera recorder and digital still camera. The lens reduces the focal length of the zoom lens by 0.6 times and allows a wider view. Attachment of this lens to the video camera recorder has no effect on light transmission nor on the sharpness of focus.

Notes on use

- Set the video camera to W (maximum width/widest point). This lens can only be used when set to W (widest). It will be out of focus if set to T (telescopic).
- Avoid rough handling or mechanical shock to the video camera recorder, especially when the lens is attached.
- Avoid keeping the lens in a very hot or humid place for a long period of time to prevent mold.
- Take the conversion lens off when transporting.
- Always attach the lens caps when storing.

Attachment (See illustrations)

The size is marked on the accessory adapter.

When the lens hood of the video camera recorder is detachable, first remove the lens hood.

- Install an adapter marked with the same size as the lens. → **1**
- Remove the caps of wide-conversion lens.
- Attach the wide-conversion lens firmly to the adaptor attached to the video camera recorder. → **2**

Focusing

- Focus with the video camera recorder’s focus ring by watching the viewfinder or monitor screen.
- Use manual focus if it proves difficult to focus some video cameras having an auto focus function.

Notes on focusing

- Focus the video camera manually when using the PROGRAM AE function. If you set focus to AUTO mode, focus may not be clear.
- If you set focus to infinity mode, focus is unclear.

Cleaning

To remove dust on the lens, use a blower brush or a soft cleaning brush. To remove fingerprints or smudges, clean with mild detergent and a soft cloth.

Specifications

Magnification	0.6 ×
Dimensions	Maximum diameter Approx. ø 75 mm (3 inch), Length Approx. 20.5 mm (¹³ ⁄ ₁₆ inch)
Mass (excluding the caps and adaptors)	Approx. 80 g
Supplied accessories	Lens caps (2) (for the front and back of the lens), Carrying Pouch (1), Instruction manual (1), Adaptors (3: 30 mm (1 ⁹ ⁄ ₁₆ inch), 37 mm (1 ¹ ⁄ ₂ inch), 52 mm (2 ¹ ⁄ ₈ inch))

Design and specifications are subject to change without notice.

	This mark indicates that this product is a genuine accessory for Sony video products. When purchasing Sony video products, Sony recommends that you purchase accessories with this "GENUINE VIDEO ACCESSORIES" mark.
---	--