

Video Cassette Recorder

Operating Instructions



SLV-SE210B **SHOWVIEW**[®]
SLV-SX110B

WARNING

To prevent fire or shock hazard, do not expose the unit to rain or moisture.

To avoid electrical shock, do not open the cabinet. Refer servicing to qualified personnel only.

Mains lead must only be changed at a qualified service shop.

Precautions

Safety

- This unit operates on 230 V AC, 50 Hz. Check that the unit's operating voltage is identical with your local power supply.
- If anything falls into the cabinet, unplug the unit and have it checked by qualified personnel before operating it any further.
- The unit is not disconnected from the mains as long as it is connected to the mains, even if the unit itself has been turned off.
- Unplug the unit from the wall outlet if you do not intend to use it for an extended period of time. To disconnect the cord, pull it out by the plug, never by the cord.

Installing

- Allow adequate air circulation to prevent internal heat buildup.
- Do not place the unit on surfaces (rugs, blankets, etc.) or near materials (curtains, draperies) that may block the ventilation slots.
- Do not install the unit near heat sources such as radiators or air ducts, or in a place subject to direct sunlight, excessive dust, mechanical vibration or shock.
- Do not install the unit in an inclined position. It is designed to be operated in a horizontal position only.
- Keep the unit and cassettes away from equipment with strong magnets, such as microwave ovens or large loudspeakers.
- Do not place heavy objects on the unit.
- If the unit is brought directly from a cold to a warm location, moisture may condense inside the VCR and cause damage to the video head and tape. When you first install the unit, or when you move it from a cold to a warm location, wait for about three hours before operating the unit.

Caution

Television programmes, films, video tapes and other materials may be copyrighted. Unauthorized recording of such material may be contrary to the provisions of the copyright laws. Also, use of this recorder with cable television transmission may require authorization from the cable television transmitter and/or programme owner.

Compatible colour systems

- This VCR is designed to record and play back using the PAL (B/G) and SECAM colour systems. Recording of video sources based on other colour systems cannot be guaranteed.
- Tapes recorded with the MESECAM colour systems can be played back on this VCR using a TV or a colour monitor supporting the SECAM colour system.

SHOWVIEW is a registered trademark of Gemstar Development Corporation. The SHOWVIEW system is manufactured under license from Gemstar Development Corporation.

Table of contents

Getting Started

- 4 Index to parts and controls
- 9 Step 1 : Unpacking
- 10 Step 2 : Setting up the remote commander
- 12 Step 3 : Connecting the VCR
- 13 Step 4 : Setting up the VCR with the Auto Set Up function
- 15 Setting the clock
- 17 Selecting a language
- 18 Presetting channels
- 21 Changing/disabling programme positions
- 26 Setting the Canal Plus decoder (SLV-SE210B only)

Basic Operations

- 29 Playing a tape
- 31 Recording TV programmes
- 34 Recording TV programmes using the ShowView system (SLV-SE210B only)
- 38 Recording TV programmes using the timer

Additional Operations

- 41 Playing/searching at various speeds
- 42 Setting the recording duration time
- 43 Checking/changing/cancelling timer settings
- 45 Adjusting the picture
- 46 Changing menu options
- 48 Editing with another VCR

Additional Information

- 50 Troubleshooting
- 53 Specifications
- 54 Index

Back Cover

Quick Start Guide

Index to parts and controls

Refer to the pages indicated in parentheses () for details.

Front panel

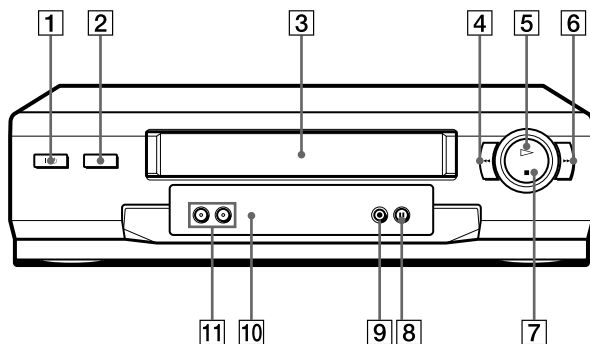

1 I/⏻ (on/standby) switch (36)

2 ⏏ (eject) button (29)

3 Tape compartment

4 ◀◀ (rewind) button (29) (41)

5 ▷ (play) button (29) (41)

6 ▶▶ (fast-forward) button (29) (41)

7 ■ (stop) button (29) (49)

8 || (pause) button (29) (49)

9 ● ENR (record) button (31) (42) (49)

10 Remote sensor (10)

11 CHAINED (programme) +/- buttons (41) (45)

Display window

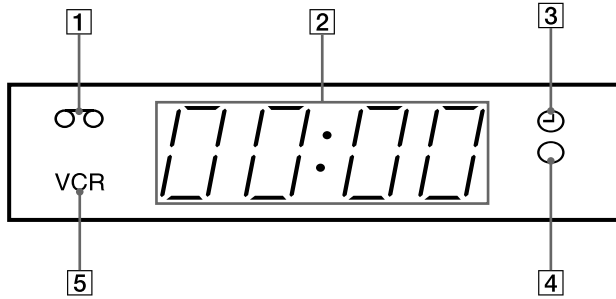

- | | |
|---|------------------------------------|
| 1 Tape indicator (37) | 3 Timer indicator (36) (39) |
| 2 Time counter/clock/line/programme position indicator (30) (31) | 4 Recording indicator (31) |
| | 5 VCR indicator (12) (32) |

continued

Rear panel

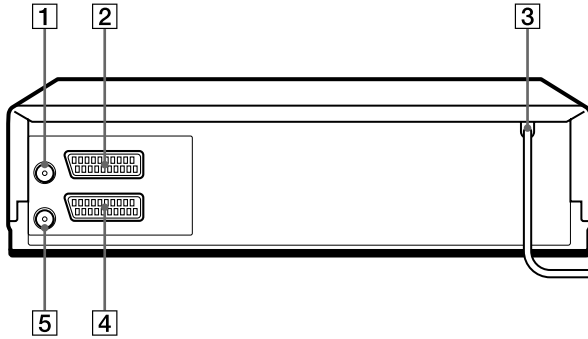

1  IN FRONT ANT. (in front antenna) connector (12)

2 AV2 IN (DÉC./EXT.) connector* (26) (48)

3 Mains lead (13)

4 AV1 (EURO AV) (av1 (euro av)) connector (12) (26)

5  OUT TO TV (out to tv) connector (12)

* SLV-SE210B only

Remote commander

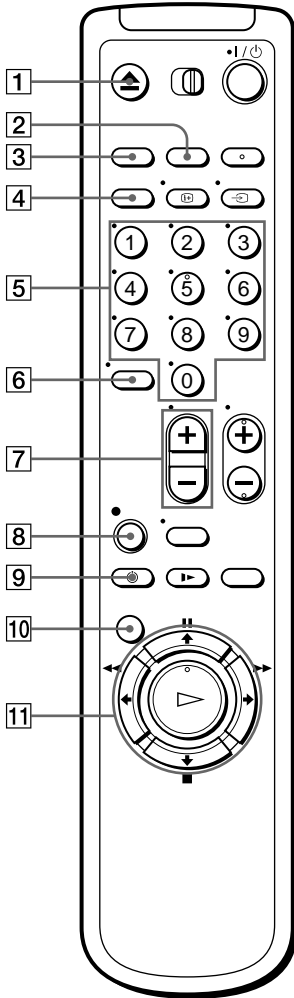

- 1** ▲ EJECT (eject) button (29)
- 2** COMPT/DUREE REST (counter/remain) button (32)
- 3** ANNUL/0 (clear) button (30) (35) (43)
- 4** SP (Standard Play)/LP (Long Play) button (This button does not operate)
- 5** Programme number buttons (11) (32)
- 6** -/- (ten's digit) button (11) (32)
- 7** ▲ (volume) +/- buttons (for TV) (11)
- 8** ● ENR (record) button (31) (42)
- 9** ⌚ MINUTERIE (timer) button (34) (38)
- 10** MENU (menu) button (15) (43)
- 11** || PAUSE (pause)/↑ button (15) (29)
 - STOP (stop)/↓ button (15) (29)
 - ◀ RET (rewind)/← button (29) (41)
 - ▶▶ AV (fast-forward)/→ button (29) (41)
 - ▷ LECTURE (play)/OK button (15) (29)

continued

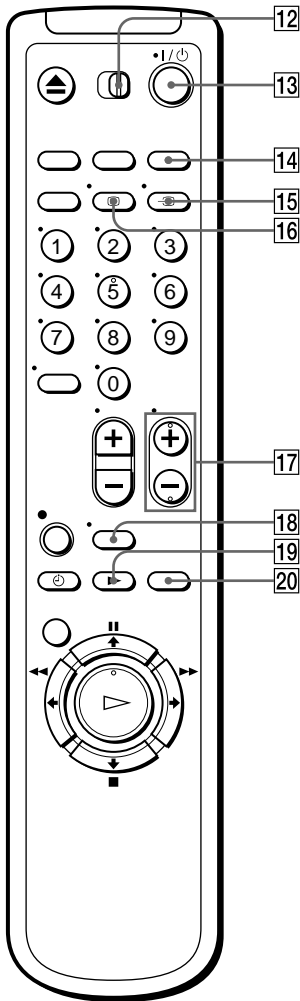

12 TV / MAGN (TV/video) remote control switch (10)

13 I/⏻ (on/standby) switch (11) (36)

14 CHOIX ENTREE (input select) button (32) (39) (49)

15 ↔ TV/MAGN (TV/video) button (11) (12) (32)

16 i+ AFFICH (display) button (32)

17 CHAINE (programme) +/- buttons (11) (31)

18 WIDE (wide) button (*for TV*) (11)

19 ► RALENTI (slow) button (41)

20 ×2 button (41)

Step 1 : Unpacking

Check that you have received the following items with the VCR:

- Remote commander
- Aerial cable

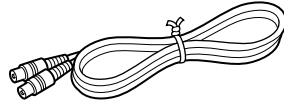
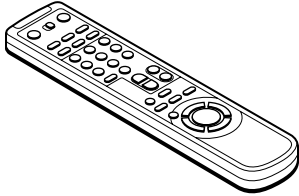

- R6 (size AA) batteries
- PERITEL cable

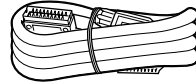
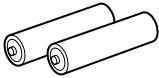

Check your model name

The instructions in this manual are for the 2 models: SLV-SE210B and SX110B. Check your model number by looking at the rear panel of your VCR. SLV-SE210B is the model used for illustration purposes. Any difference in operation is clearly indicated in the text, for example, "SLV-SX110B only."

Step 2 : Setting up the remote commander

Inserting the batteries

Insert two R6 (size AA) batteries by matching the + and – on the batteries to the diagram inside the battery compartment.

Insert the negative (–) end first, then push in and down until the positive (+) end clicks into position.

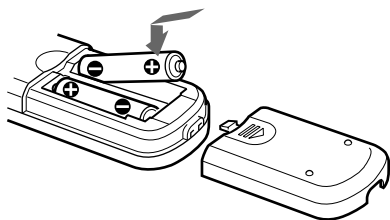

Using the remote commander

You can use this remote commander to operate this VCR and a Sony TV. Buttons on the remote commander marked with a dot (•) can be used to operate your Sony TV. If the TV does not have the  symbol near the remote sensor, this remote commander will not operate the TV.

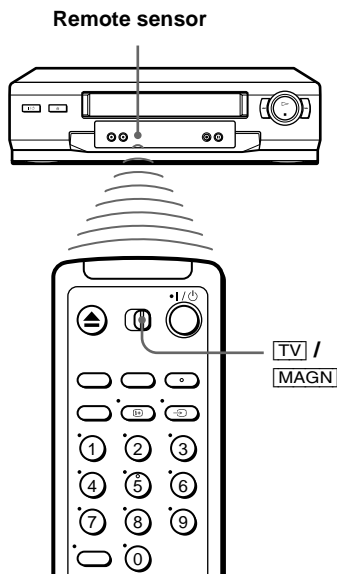

To operate	Set TV / MAGN to
the VCR	MAGN and point at the remote sensor at the VCR
a Sony TV	TV and point at the remote sensor at the TV

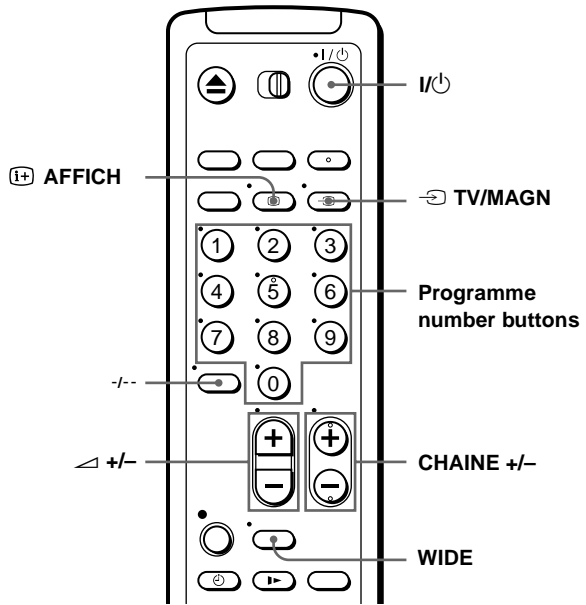

TV control buttons

To	Press
Set the TV to standby mode	I/⏻
Select an input source: aerial in or line in	TV/MAGN
Select the TV's programme position	Programme number buttons, -/-. , CHAINE +/-
Adjust the volume of the TV	△ +/-
Call up the on-screen display	i+ AFFICH
Switch to/from wide mode of a Sony wide TV	WIDE

Notes

- With normal use, the batteries should last about three to six months.
- If you do not use the remote commander for an extended period of time, remove the batteries to avoid possible damage from battery leakage.
- Do not use a new battery together with an old one.
- Do not use different types of batteries together.
- Some buttons may not work with certain Sony TVs.

Step 3 : Connecting the VCR

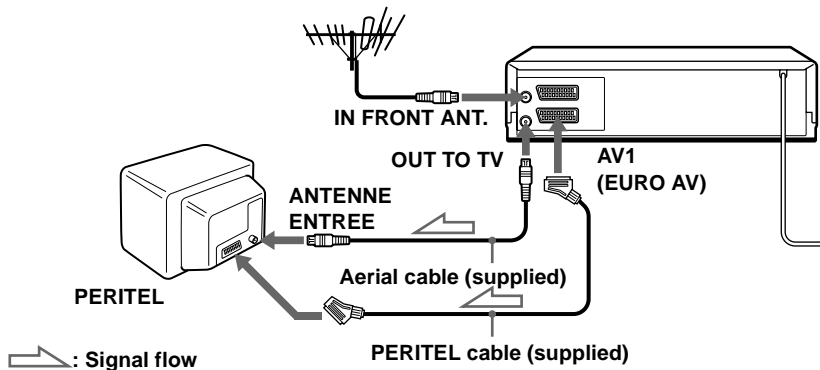

1

Disconnect the aerial cable from your TV and connect it to IN FRONT ANT. on the rear panel of the VCR.

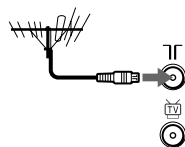

2

Connect OUT TO TV of the VCR and the aerial input of your TV using the supplied aerial cable.

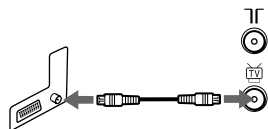

3

Connect AV1 (EURO AV) on the VCR and the PERITEL connector on the TV with the supplied PERITEL cable.

This connection improves picture and sound quality. Whenever you want to watch the VCR picture, press TV/MAGN to display the VCR indicator in the display window.

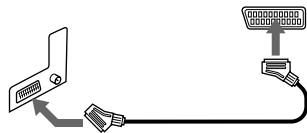

Tip

- If your TV does not have a PERITEL connector, use the VMC-2106HG cable instead and connect the cable to the line in jacks of your TV.

Step 4 : Setting up the VCR with the Auto Set Up function

Before using the VCR for the first time, set up the VCR using the Auto Set Up function. With this function, you can set the TV channels, guide channels for the ShowView system*, and VCR clock* automatically.

1 Turn on your TV and set it to video input.

2 Connect the mains lead to the mains.
The VCR automatically turns on, and the message for the Auto Set Up function appears.

3 Press OK.
The SÉLECTION DU PAYS menu appears.

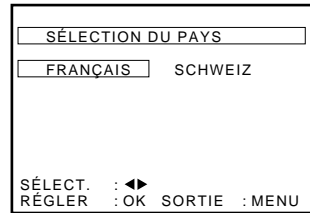

4 Press ◀/▶ to select your country, then press OK.



The VCR starts searching for all of the receivable channels and presets them (in the appropriate order for your local area).

If you want to change the order of the channels or disable unwanted programme positions, see “Changing/disabling programme positions” on page 21.

After the search or download is complete, the current time appears for any stations that transmit a time signal. If the time does not appear, set the clock manually. See “Setting the clock” on page 15.



continued

To cancel the Auto Set Up function

Press MENU.

Tip

- If you want to change the language for the on-screen display, see page 17.

Notes

- Whenever you operate the Auto Set Up function, some of the settings (ShowView*, timer, etc.) will be reset. If this happens, you have to set them again.
- After using the Auto Set Up function, the message for the Auto Set Up function does not appear automatically when you connect the mains lead again. If you want to use the Auto Set Up function again, press MENU, then press **↑/↓/←/→** to highlight INSTALLATION and press OK. Press **↑/↓** to highlight INSTALLATION AUTO, then repeat all procedures from step 3.

* SLV-SE210B only

Setting the clock

You must set the time and date on the VCR to use the timer features properly.

The Auto Clock Set function works only if a station in your area is broadcasting a time signal.

Before you start...

- Turn on the VCR and the TV.
- Set the TV to video input.
- Refer to “Index to parts and controls” for button locations.

1

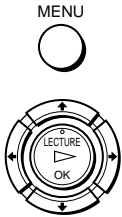

Press MENU, then press **↑/↓/←/→** to highlight RÉGLAGE HORLOGE and press OK.

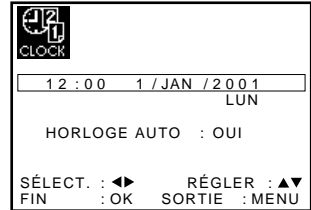

2



Press **↑/↓** to set the hour.

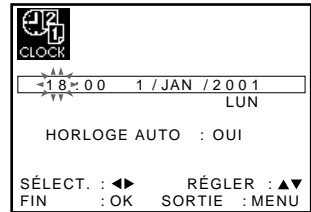

3



Press **→** to select the minutes and set the minutes by pressing **↑/↓**.

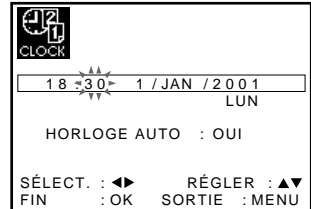

continued

4



Set the day, month, and year in sequence by pressing \rightarrow to select the item to be set, and press \uparrow/\downarrow to select the digits, then press \rightarrow .

The day of the week is set automatically.

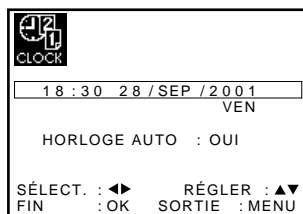

5

Press \uparrow/\downarrow to select OUI for the setting the Auto Clock Set function.

The VCR automatically set the clock by the channel between PR01 to PR05 broadcasting the time signal.

If you do not need the Auto Clock Set function, select NON.

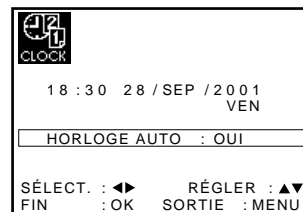

6



Press MENU to exit the menu.

Tips

- If you set HORLOGE AUTO to OUI, the Auto Clock Set function is activated whenever the VCR is turned off. The time is adjusted automatically by making reference to the time signal from the station.
- To change the digits while setting, press \leftarrow to return to the item to be changed, and select the digits by pressing \uparrow/\downarrow .

Selecting a language

If you prefer an on-screen language other than French, use the on-screen display to select another language.

Before you start...

- Turn on the VCR and the TV.
- Set the TV to video input.
- Refer to “Index to parts and controls” for button locations.

1

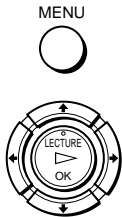

Press MENU, then press **↑/↓/←/→** to highlight **SÉLECTION LANGUE** and press OK.

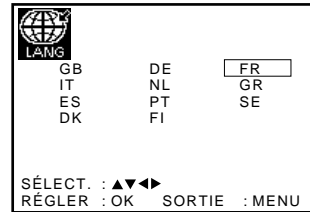

2



Press **↑/↓/←/→** to highlight the abbreviation of the desired language from the table below, then press OK.

The abbreviations of the languages are as follows:

Abbreviation	Language
GB	English
DE	German
FR	French
IT	Italian
NL	Dutch
GR	Greek

Abbreviation	Language
ES	Spanish
PT	Portuguese
SE	Swedish
DK	Danish
FI	Finnish

Presetting channels

If some channels could not be preset using the Auto Set Up function, you can preset them manually.

Before you start...

- Turn on the VCR and the TV.
- Set the TV to video input.
- Refer to "Index to parts and controls" for button locations.

1

MENU



Press MENU, then press **↑/↓/←/→** to highlight **INSTALLATION** and press **OK**.

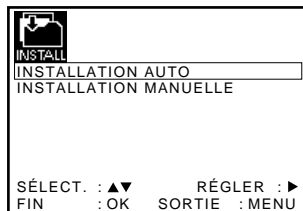

2



Press **↑/↓** to highlight **INSTALLATION MANUELLE**, then press **→**.

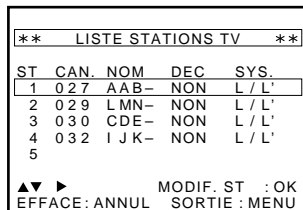

3



Press **↑/↓** to highlight the row which you want to preset, then press **→**.

To display other pages for programme position 6 to 80, press **↑/↓** repeatedly.

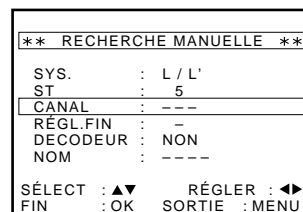

4



Press **←/→** repeatedly until the channel you want is displayed.

** RECHERCHE MANUELLE **	
SYS.	: L / L'
ST	: 5
CANAL	: 033
RÉGL.FIN	: -
DECODEUR	: NON
NOM	: ----
SÉLECT	: ▲▼ RÉGLER : ◀▶
FIN	: OK SORTIE : MENU

5



Press **↑/↓** to highlight SYS.

** RECHERCHE MANUELLE **	
SYS.	: L / L'
ST	: 5
CANAL	: 033
RÉGL.FIN	: -
DECODEUR	: NON
NOM	: ----
SÉLECT	: ▲▼ RÉGLER : ◀▶
FIN	: OK SORTIE : MENU

6



Press **←/→** to set L/L' or B/G.

- To receive broadcasts in France, highlight L/L'.
- To receive broadcasts using the PAL system (for example, in Germany or Switzerland), highlight B/G.

7



Press **↑/↓** to highlight NOM, then press **→**.

** RECHERCHE MANUELLE **	
SYS.	: L / L'
ST	: 5
CANAL	: 033
RÉGL.FIN	: -
DECODEUR	: NON
NOM	: → ← --
SÉLECT.	: ▲▼ RÉGLER : ◀▶
FIN	: OK SORTIE : MENU

continued

8

Enter the station name.

- 1 Press **↑/↓** to select a character.
Each time you press **↑**, the character changes as shown below.
A → B → ... → Z → 0 → 1 → ... → 9 → A

- 2 Press **→** to set the next character.

The next space is flashed.

To correct a character, press **←/→** until the character you want to correct is flashed, then reset it.

You can set up to 4 characters for the station name.

** RECHERCHE MANUELLE **	
SYS.	: L / L'
ST	: 5
CANAL	: 0 3 3
RÉGL.FIN	: -
DECODEUR	: NON
NOM	: → 0 * --
SÉLECT. : ▲▼	RÉGLER : ◀▶
FIN : OK	SORTIE : MENU

9

Press **OK** to confirm the station name.

10

MENU



Press **MENU** to exit the menu.

If the picture is not clear

If the picture is not clear, you may use the Manual Fine Tuning (RÉGL.FIN) function. After step 4, press **↑/↓** to select RÉGL.FIN. Press **←/→** to get a clear picture, then press **MENU** to exit the menu.

Tip

- To set the programme position for the decoder, see “Setting the Canal Plus channels” on page 26.

Note

- When adjusting RÉGL.FIN, the menu may become difficult to read due to interference from the picture being received.

Changing/disabling programme positions

After setting the channels, you can change the programme positions as you like. If any programme positions are unused or contain unwanted channels, you can disable them.

You can also change the station names. If the station names are not displayed, you can enter them manually.

Changing programme positions

Before you start...

- Turn on the VCR and the TV.
- Set the TV to video input.
- Refer to “Index to parts and controls” for button locations.

1

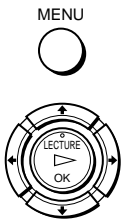

Press MENU, then press **↑/↓/←/→** to highlight INSTALLATION and press OK.

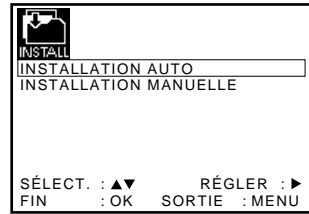

2



Press **↑/↓** to highlight INSTALLATION MANUELLE, then press **→**.

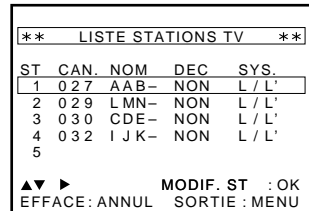

3



Press **↑/↓** to highlight the row which you want to change the programme position.

To display other pages for programme positions 6 to 80, press **↑/↓** repeatedly.

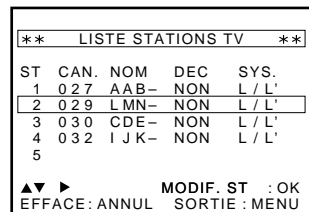

continued

4



Press OK, then press **↑/↓** to move to the desired programme position.

ST	CAN.	NOM	DEC	SYS.
1	027	AAB-	NON	L / L'
2				
3	030	CDE-	NON	L / L'
4	032	KMN-	NON	L / L'
5	029	LMN-	NON	L / L'

▲▼ MODIF. ST : OK
SORTIE : MENU

5



Press OK to confirm the setting.

6

To change the programme position of another station, repeat steps 3 through 5.

7



Press MENU to exit the menu.

Disabling unwanted programme positions

After presetting channels, you can disable unused programme positions. The disabled positions will be skipped later when you press the CHAINE +/- buttons.

Before you start...

- Turn on the VCR and the TV.
- Set the TV to video input.
- Refer to “Index to parts and controls” for button locations.

1



Press MENU, then press **↑/↓/←/→** to highlight INSTALLATION, and press OK.

INSTALL	
INSTALLATION AUTO	
INSTALLATION MANUELLE	

SÉLECT. : ▲▼ RÉGLER : ►
FIN : OK SORTIE : MENU

2



Press **↑/↓** to highlight
INSTALLATION MANUELLE,
then press **→**.

** LISTE STATIONS TV **				
ST	CAN.	NOM	DEC	SYS.
1	027	AAB-	NON	L/L'
2	029	LMN-	NON	L/L'
3	030	CDE-	NON	L/L'
4	032	IJK-	NON	L/L'
5				

▲▼ ► MODIF. ST : OK
EFFACE: ANNUL SORTIE : MENU

3



Press **↑/↓** to highlight the row
which you want to disable.

To display other pages for
programme positions 6 to 80, press
↑/↓ repeatedly.

** LISTE STATIONS TV **				
ST	CAN.	NOM	DEC	SYS.
1	027	AAB-	NON	L/L'
2	029	LMN-	NON	L/L'
3	030	CDE-	NON	L/L'
4	032	IJK-	NON	L/L'
5				

▲▼ ► MODIF. ST : OK
EFFACE: ANNUL SORTIE : MENU

4



Press **ANNUL/O**.

The selected row will be cleared as
shown on the right.

** LISTE STATIONS TV **				
ST	CAN.	NOM	DEC	SYS.
1	027	AAB-	NON	L/L'
2				
3	030	CDE-	NON	L/L'
4	032	IJK-	NON	L/L'
5				

▲▼ ► MODIF. ST : OK
EFFACE: ANNUL SORTIE : MENU

5

Repeat steps 3 and 4 for any other programme positions you want to disable.

6



Press **MENU** to exit the menu.

Note

- Be sure to select the programme position you want to disable correctly. If you disable a programme position by mistake, you need to reset that channel manually.

continued

Changing the station names

You can change or enter the station names (up to 4 characters). The VCR must receive channel information for station names to appear automatically.

Before you start...

- Turn on the VCR and the TV.
- Set the TV to video input.
- Refer to "Index to parts and controls" for button locations.

1

MENU



Press MENU, then press **↑/↓/←/→** to highlight **INSTALLATION** and press **OK**.

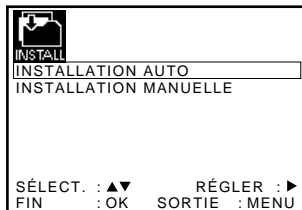

2



Press **↑/↓** to highlight **INSTALLATION MANUELLE**, then press **→**.

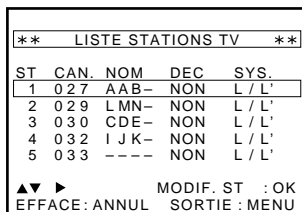

3



Press **↑/↓** to highlight the row which you want to change or enter the station name, then press **→**.

To display other pages for programme positions 6 to 80, press **↑/↓** repeatedly.

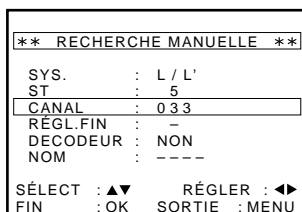

4



Press **↑/↓** to highlight **NOM**, then press **→**.

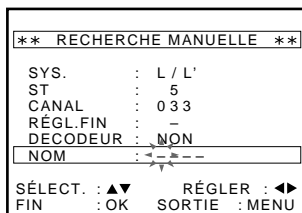

5



Enter the station name.

- 1 Press **↑/↓** to select a character.
 Each time you press **↑**, the character changes as shown below.
A → **B** → ... → **Z** → **0** → **1** →
 ... → **9** → **A**

- 2 Press **→** to set the next character.

The next space is flashed.

To correct a character, press **←/→** until the character you want to correct is flashed, then reset it.

You can set up to 4 characters for the station name.

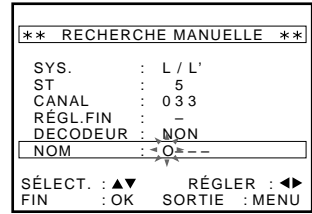

6



Press **OK** to confirm the new name.

7



Press **MENU** to exit the menu.

Setting the Canal Plus decoder (SLV-SE210B only)

You can watch or record the Canal Plus programmes if you connect a decoder (not supplied) to the VCR.

Connecting a decoder

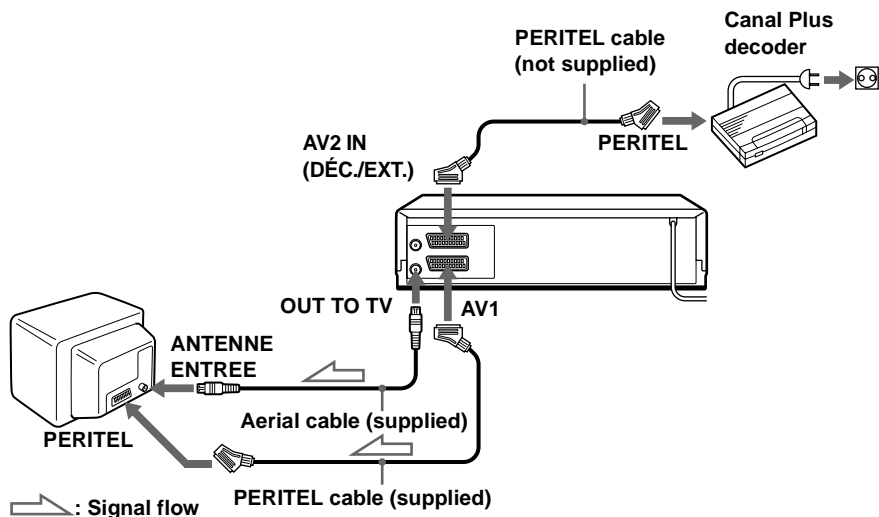

Setting the Canal Plus channels

To watch or record the Canal Plus programmes, set your VCR to receive the channels using the on-screen display.

In order to set the channels correctly, be sure to follow all of the steps below.

Before you start...

- Turn on the VCR, the TV, and the decoder.
- Set the TV to video input.
- Refer to "Index to parts and controls" for button locations.

1

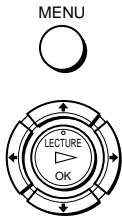

Press MENU, then press $\uparrow/\downarrow/\leftarrow/$
 \rightarrow to highlight INSTALLATION
 and press OK.

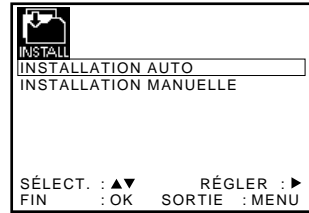

2



Press \uparrow/\downarrow to highlight
 INSTALLATION MANUELLE,
 then press \rightarrow .

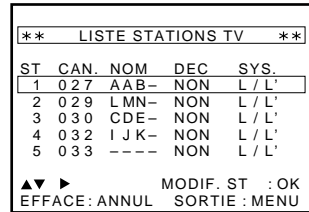

3



Press \uparrow/\downarrow to highlight the row
 which you want to set for the
 decoder, then press \rightarrow .

To display positions 6 to 80, press
 \uparrow/\downarrow repeatedly.

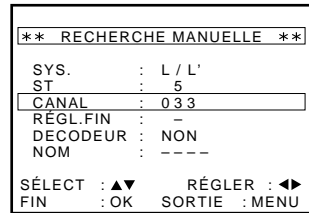

4



Press \uparrow/\downarrow to highlight SYS.

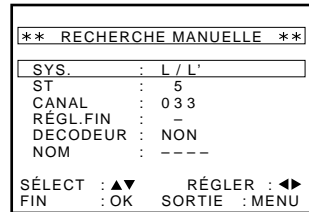

5



Press \leftarrow/\rightarrow to set L/L' or B/G.

- To receive broadcasts in France, highlight L/L'.
- To receive broadcasts using the PAL system (for example, in Germany or Switzerland), highlight B/G.

continued

6

Press **↑/↓** to highlight
DECODEUR.

** RECHERCHE MANUELLE **	
SYS.	: L / L'
ST	: 5
CANAL	: 0 3 3
RÉGL.FIN	: -
DECODEUR	: NON
NOM	: - - - -
SÉLECT. : ▲▼	RÉGLER : ◀▶
FIN : OK	SORTIE : MENU

7

Press **→** to set DECODEUR to
OUI, then press OK.

** RECHERCHE MANUELLE **	
SYS.	: L / L'
ST	: 5
CANAL	: 0 3 3
RÉGL.FIN	: -
DECODEUR	: OUI
NOM	: - - - -
SÉLECT. : ▲▼	RÉGLER : ◀▶
FIN : OK	SORTIE : MENU

8

Press MENU to exit the menu.

Notes

- To superimpose subtitles while watching the Canal Plus programmes, make both decoder-VCR and VCR-TV connections using 21-pin PERITEL cables that are compatible with the RGB signals. You cannot record subtitles on the VCR.
- When you watch the Canal Plus programmes through the RFU input of the TV, press **⇒** TV/MAGN so that the VCR indicator appears in the display window.

Playing a tape

Before you start...

- Refer to “Index to parts and controls” for button locations.

1 Turn on your TV and set it to video input.

2 Insert a tape.
The VCR turns on and starts playing automatically if you insert a tape with its safety tab removed.

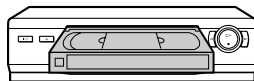

3 Press  LECTURE.
When the tape reaches the end, it will rewind automatically.



Additional tasks

To	Press
Stop play	■ STOP
Pause play	PAUSE
Resume play after pause	PAUSE or ▷ LECTURE
Fast-forward the tape	▶▶ AV during stop
Rewind the tape	◀◀ RET during stop
Eject the tape	▲ EJECT

To set the colour system

If the playback picture has no colour, or streaks appear during palyback, set the SYST. COULEUR option in the RÉGLAGES UTILISATEUR menu to conform to the system that the tape was recorded in (see page 46). (Normally set the option to AUTO).

To use the time counter

Press ANNUL/0 at the point on the tape that you want to find later. The counter in the display window resets to “00:00.” Search for the point afterwards by referring to the counter.



To display the counter on the TV screen, press **Ⓜ** AFFICH.

Notes

- The counter resets to “00:00” whenever a tape is reinserted.
- The counter stops counting when it comes to a portion with no recording.
- Depending on your TV, the following may occur while playing an NTSC-recorded tape:
 - The picture becomes black and white.
 - The picture shakes.
 - No picture appears on the TV screen.
 - Black streaks appear horizontally on the TV screen.
 - The colour density increases or decreases.
- While setting the menu on the TV screen, buttons for playback on the remote commander do not function.

Recording TV programmes

Before you start...

- Refer to “Index to parts and controls” for button locations.

1 Turn on your TV and set it to video input.
To record from a decoder, turn it on.

2 Insert a tape with its safety tab in place.

3 Press CHAINE +/- to select the programme position you want to record.

• CHAINE

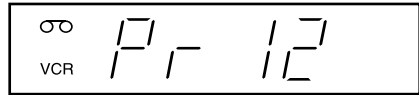

4 Press ● ENR to start recording.
The recording indicator lights up red in the display window.

● ENR



Recording indicator

To stop recording

Press ■ STOP.

To check the remaining time

Press **(+)** AFFICH. With the display on, press COMPT/DUREE REST to check the remaining time. Each time you press COMPT/DUREE REST, the time counter and the remaining time appear alternately.

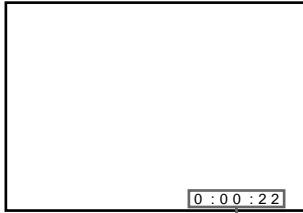

Time counter

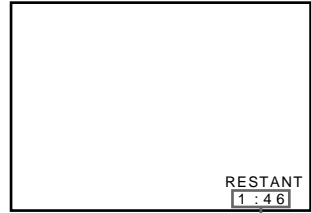

Remaining time

In order to get an accurate remaining time indication, be sure **SÉLECT. CASSETTE** in the **RÉGLAGES UTILISATEUR** menu is set according to the tape type you use (see page 46).

To watch another TV programme while recording

- 1 Press **(TV)** TV/MAGN to turn off the VCR indicator in the display window.
- 2 Select another programme position on the TV.

To save a recording

To prevent accidental erasure, break off the safety tab as illustrated. To record on the same tape again, cover the tab hole with adhesive tape.

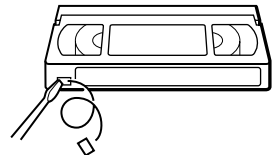

Safety tab

Tips

- To select a programme position, you can use the programme number buttons on the remote commander. For two-digit numbers, press the **-/-** (ten's digit) button followed by the programme number buttons.
- If you connect additional equipment to an input connector, you can select the input signal using the **CHOIX ENTREE** or **CHAINE +/-** buttons.
- The **(+)** AFFICH information appears on the TV screen indicating information about the tape, but the information won't be recorded on the tape.
- If you don't want to watch TV while recording, you can turn off the TV. When using a decoder, make sure to leave it on.

Notes

- The  AFFICH information does not appear during pause mode and the various speeds of playback mode. However, it will appear during normal playback.
- If a tape has portions recorded in both PAL (SECAM, MESECAM) and NTSC systems, the time counter reading will not be correct. This discrepancy is due to the difference between the counting cycles of the two video systems.
- You cannot watch a Canal Plus programme while recording another Canal Plus programme*.
- When you insert a non-standard commercially available tape, the remaining time may not be correct.
- The remaining time is intended for rough measurement only.
- About 30 seconds after the tape begins playback, the tape remaining time will be displayed.

* SLV-SE210B only

Recording TV programmes using the ShowView system (SLV-SE210B only)

The ShowView system is the feature that simplifies programming the VCR to make timer recordings. Just enter the ShowView number listed in the TV programme guide. The date, times, and programme position of that programme are set automatically. You can preset a total of six programmes, including settings made with other timer methods.

Before you start...

- Check that the VCR clock is set to the correct time and date.
- Insert a tape with its safety tab in place. Make sure the tape is longer than the total recording time.
- To record from a decoder, turn it on.
- Turn on your TV and set it to video input.
- Set OPTIONS PROG. to SHOWVIEW or MIXTE in the RÉGLAGES UTILISATEUR menu (see page 47).
- Refer to “Index to parts and controls” for button locations.

1

MINUTERIE



Press MINUTERIE.

- When you set OPTIONS PROG. to MIXTE:
The OPTIONS PROG. menu appears on the TV screen. Press / to select SHOWVIEW, then press OK.
- When you set OPTIONS PROG. to SHOWVIEW:
The SHOWVIEW menu appears on the TV screen.

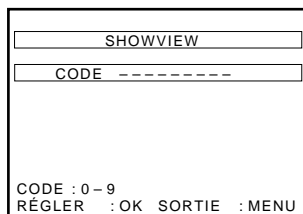
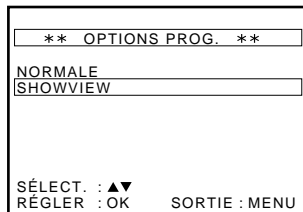

2

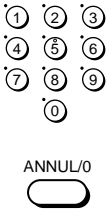

Press the programme number buttons to enter the ShowView number.

If you make a mistake, press ANNUL/0 and re-enter the correct number.

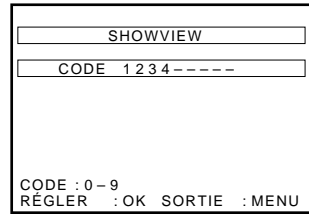

3



CHOIX ENTREE



ANNUL/0



Press OK.

The programme position, date, start and stop times, and PDC setting appear on the TV screen.

- If “--” appears in the “ST” column (this may happen for local broadcasts), you have to set the appropriate programme position manually.

Press \uparrow/\downarrow to select the desired programme position.

To record from a decoder or other source connected to the input connector, press CHOIX ENTREE to display the connected line in the “ST” position.

You will only have to do this operation once for the referred channel. The VCR will then store your setting.

If the information is incorrect, press ANNUL/0 to cancel the setting.

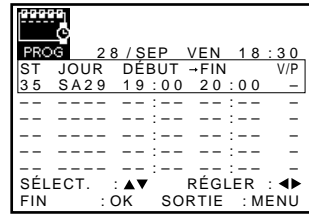

4



If you want to change the date and the PDC setting:

1 Press \leftarrow/\rightarrow to select the item you want to change.

2 Press \uparrow/\downarrow to reset it.

- To record the same programme every day or the same day every week, see “Daily/weekly recording” on page 36.
- To use the PDC function, set V/P to P. For details about the PDC function, see “Timer recording with PDC signals” on page 36.

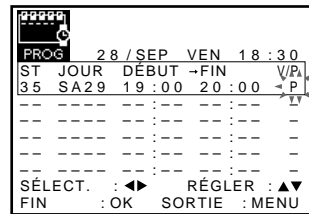

5

MENU



Press MENU to exit the menu.

continued

6



Press I/⏻ to turn off the VCR.

The ⏻ indicator appears in the display window and the VCR stands by for recording.

To record from a decoder or other source, leave the connected equipment switched on.

To stop recording

To stop the VCR while recording, press ■ STOP.

Daily/weekly recording

In step 4 above, press ↓ to select the recording pattern. Each time you press ↓, the indication changes as shown below. Press ↑ to change the indication in reverse order.

today → JOUR (Monday to Sunday) → S-SA (every Saturday) → S-DI (every Sunday) → 1 month later → (dates count down) → today

Timer recording with PDC signals

Some broadcast systems transmit PDC (Programme Delivery Control) signals with their TV programmes. These signals ensure that your timer recordings are made regardless of broadcast delays, early starts, or broadcast interruptions.

To use the PDC function, set V/P to P in step 4 above. You can also use the PDC function for a source connected to the input connector.

To use the VCR after setting the timer

To use the VCR before a recording begins, just press I/⏻. The ⏻ indicator turns off and the VCR switches on. Remember to press I/⏻ to reset the VCR to recording standby after using the VCR.



You can also do the following tasks while the VCR is recording:

- Reset the counter (page 30).
- Display tape information on the TV screen (page 32).
- Check the timer settings (page 43).
- Watch another TV programme (page 32).

Tips

- You can set the extended time for the ShowView setting by 10, 20, 30, or 60 minutes. Set ÉTENDRE SHOWVIEW in the FONCTIONS AVANÇÉES menu to the desired extended time (page 47).
- To check, change, or cancel the programme setting, see “Checking/changing/cancelling timer settings” (page 43).

Notes

- If the PDC signal is too weak or the broadcasting station failed to transmit PDC signals, the VCR will start recording at the set time without using the PDC function.
- The  and  indicators flash in the display window when you press  with no tape inserted.
- When you set OPTIONS PROG. to NORMALE in the RÉGLAGES UTILISATEUR menu, the SHOWVIEW menu does not appear on the TV screen. Select SHOWVIEW or MIXTE.
- The PDC function is automatically set to off for the timer recording of a satellite programme.

Recording TV programmes using the timer

You can preset a total of six programmes, including settings made with other timer methods.

Before you start...

- Check that the VCR clock is set to the correct time and date.
- Insert a tape with its safety tab in place. Make sure the tape is longer than the total recording time.
- To record from a decoder, turn it on.
- Turn on your TV and set it to video input.
- Set OPTIONS PROG. to NORMALE or MIXTE in the RÉGLAGES UTILISATEUR menu (see page 47).
- Refer to "Index to parts and controls" for button locations.

1

MINUTERIE



Press MINUTERIE.

For SLV-SX110B only



The MINUTERIE menu appears on the TV screen.

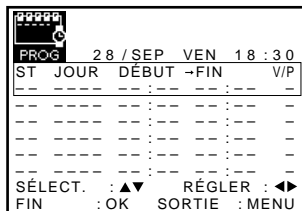

For SLV-SE210B only

- When you set OPTIONS PROG. to MIXTE:

The OPTIONS PROG. menu appears on the TV screen. Press to select NORMALE, then press OK.

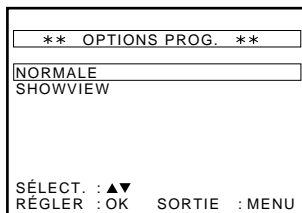

- When you set OPTIONS PROG. to NORMALE:

The MINUTERIE menu appears on the TV screen.

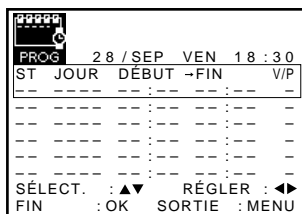

2



Set the programme position, date, start and stop times, and PDC function:

1 Press **→** to select each item in turn.

2 Press **↑/↓** to set each item.

To correct a setting, press **←** to return to that setting and reset.

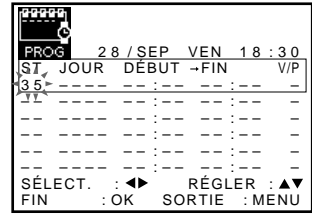

- To record the same programme every day or the same day every week, see “Daily/weekly recording” on page 39.
- To use the PDC function*, set V/P to P. For details about the PDC function, see “Timer recording with PDC signals” on page 36.
- To record from a decoder or other source connected to the input connector, press CHOIX ENTREE to display the connected line in the “ST” position.

3



Press MENU to exit the menu.

4



Press **I/O** to turn off the VCR.

The **Ⓢ** indicator appears in the display window and the VCR stands by for recording.

To record from a decoder or other source, leave the connected equipment switched on.

To stop recording

To stop the VCR while recording, press **■ STOP**.

Daily/weekly recording

In step 2 above, press **↓** to select the recording pattern. Each time you press **↓**, the indication changes as shown below. Press **↑** to change the indication in reverse order.

today → **JOUR (Monday to Sunday)** → **S-SA (every Saturday)** → **S-DI (every Sunday)** → **1 month later** → **(dates count down)** → **today**

continued

To use the VCR after setting the timer

To use the VCR before a recording begins, just press I/⏻. The ⏻ indicator turns off and the VCR switches on. Remember to press I/⏻ to reset the VCR to recording standby after using the VCR.

You can also do the following tasks while the VCR is recording:

- Reset the counter (page 30).
- Display tape information on the TV screen (page 32).
- Check the timer settings (page 43).
- Watch another TV programme (page 32).

Tips

- Even if you set OPTIONS PROG. to SHOWVIEW in the RÉGLAGES UTILISATEUR menu, you can set the timer manually. Press MENU to select MINUTERIE, then go to step 2.
- To check, change, or cancel the programme setting, see “Checking/changing/cancelling timer settings” (page 43).

Notes

- When setting the timer with PDC signals, enter the start and stop times exactly as indicated in the TV programme guide. Otherwise, the PDC function won't work*.
- If the PDC signal is too weak or the broadcasting station failed to transmit PDC signals, the VCR will start recording at the set time without using the PDC function*.
- The ⏻ and ⏻ indicators flash in the display window when you press I/⏻ with no tape inserted.
- The PDC function is automatically set to off for the timer recording of a satellite programme*.

* SLV-SE210B only

Playing/searching at various speeds

Before you start...

- Refer to “Index to parts and controls” for button locations.

Playback options	Operation
View the picture during fast-forward or rewind	During fast-forward, hold down ►► AV. During rewind, hold down ◀◀ RET.
Play at high speed	<ul style="list-style-type: none"> • During playback, press ►► AV or ◀◀ RET. • During playback, hold down ►► AV or ◀◀ RET. When you release the button, normal playback resumes.
Play at twice the normal speed	During playback, press ×2.
Play in slow motion	During playback, press ►► RALENTI.
Play frame by frame	During pause, press ►► AV.

To resume normal playback

Press ▷ LECTURE.

Tip

- Adjust the picture using the CHAINE +/- buttons on the VCR if:
 - Streaks appear while playing in slow motion.
 - Bands appear at the top or bottom while pausing.
 - The picture shakes while pausing.

Notes

- The sound is muted during these operations.
- If the playback mode mark doesn't appear on the TV screen, press ⓘ AFFICH.
- The picture may show noise when playing at high speed in reverse.

Setting the recording duration time

After you have started recording in the normal way, you can have the VCR stop recording automatically after a specified duration.

Before you start...

- Refer to “Index to parts and controls” for button locations.

1 While recording, press ● ENR.

The ⊖ indicator appears in the display window.

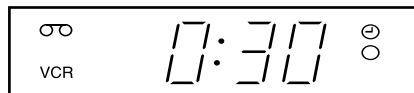

2 Press ● ENR repeatedly to set the duration time.

Each press advances the time in increments of 30 minutes.

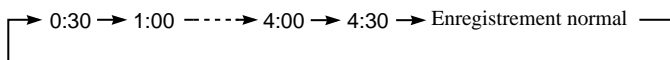

The tape counter decreases minute by minute to 0:00, then the VCR stops recording and turns off automatically.

To extend the duration

Press ● ENR repeatedly to set a new duration time.

To cancel the duration

Press ● ENR repeatedly until the ⊖ indicator disappears and the VCR returns to the normal recording mode.

To stop recording

To stop the VCR while recording, press ■ STOP.

Note

- You cannot display the current tape time in the display window when setting the recording duration time.

Checking/changing/cancelling timer settings

Before you start...

- Turn on your TV and set it to video input.
- Refer to “Index to parts and controls” for button locations.

- 1** Press I/⏻ to turn on the VCR.
- 2** Press MENU, then press ↑/↓ to highlight MINUTERIE and press OK.

- If you want to change or cancel a setting, go on to the next step.
- If you do not need to change or cancel the settings, press MENU, then turn off the VCR to return to recording standby.

ST	JOUR	DÉBUT	→FIN	V/P
35	SA 29	19 : 00	20 : 00	-
29	SA 29	21 : 00	21 : 30	-
30	SA 6	12 : 00	13 : 30	-

- 3** Press ↑/↓ to select the setting you want to change or cancel, then press →.

The ST number on the selected row flashes.

ST	JOUR	DÉBUT	→FIN	V/P
35	SA 29	19 : 00	20 : 00	-
29	SA 29	21 : 00	21 : 30	-
30	SA 6	12 : 00	13 : 30	-

- 4** • To change the setting, press ←/→ to select the item you want to change, then press ↑/↓ to reset it.
- To cancel the setting, press ANNUL/0.
- 5** Press MENU to exit the menu.

If any settings remain, turn off the VCR to return to recording standby.

When the timer settings overlap

The programme that starts first has priority and the second programme starts recording only after the first programme has finished. If the programmes start at the same time, the programme listed first in the menu has priority.

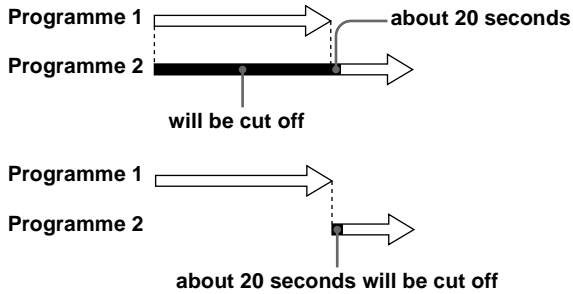

Adjusting the picture

Adjusting the tracking

Although the VCR automatically adjusts the tracking when playing a tape, distortion may occur if the recording is in poor condition. In this case, manually adjust the tracking.

During playback, press **CHAINE +/-** on the VCR to display the tracking meter. The distortion should disappear as you press one of the two buttons. To resume automatic tracking adjustments, eject the tape and re-insert it.

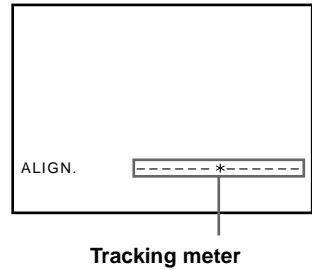

Adjusting the picture sharpness

You can manually adjust the sharpness of the picture.

1 During playback, press MENU, then press **↑/↓/←/→** to highlight RÉGLAGES UTILISATEUR and press OK.

2 Press **↑/↓** to highlight IMAGE, then press **→**.

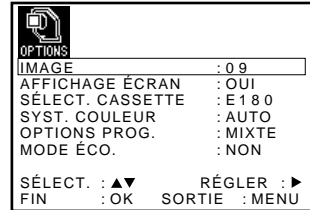

3 Press **←/→** to adjust the sharpness.

To soften the picture, press **←**.

To sharpen the picture, press **→**.

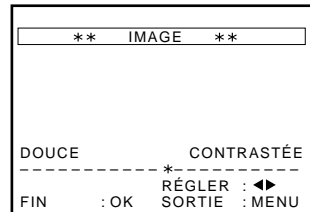

4 Press MENU to exit the menu.

Changing menu options

- 1 Press MENU, then select RÉGLAGES UTILISATEUR or FONCTIONS AVANCÉES and press OK.

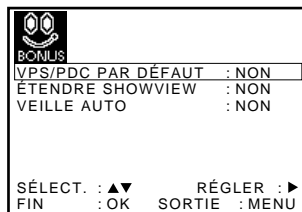
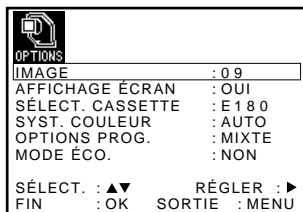

- 2 Press **↑/↓** to select the option.
- 3 Press **→** to change the setting, then press OK.
- 4 Press MENU to return to the original screen.

Menu choices

Initial settings are indicated in bold print.

RÉGLAGES UTILISATEUR

Menu option	Set this option to
IMAGE	Adjusting the sharpness of the picture by pressing ←/→ buttons. Press ← to adjust the picture getting softness. Press → to adjust the picture getting sharpness.
AFFICHAGE ÉCRAN	<ul style="list-style-type: none"> • OUI to display the menu on the TV screen. • NON to disappear the menu from the TV screen.
SÉLECT. CASSETTE	<ul style="list-style-type: none"> • E180 to use an E-180 or shorter type tape. • E240 to use an E-240 type tape. • E260 to use an E-260 type tape. • E300 to use an E-300 type tape.
SYST. COULEUR	<ul style="list-style-type: none"> • AUTO to select the colour system automatically. • PAL to use the tape recorded in the PAL colour system. • SECAM to use the tape recorded in the SECAM colour system. • MESECAM to use the tape recorded in the MESECAM colour system. • N/B to use the tape recorded in black and white.

Menu option	Set this option to
OPTIONS PROG.*	<ul style="list-style-type: none"> • MIXTE to display the OPTIONS PROG. menu for selecting NORMALE or SHOWVIEW when pressing the ⏻ MINUTERIE button. • NORMALE to display the PROG menu when pressing the ⏻ MINUTERIE button. • SHOWVIEW to display the SHOWVIEW menu when pressing the ⏻ MINUTERIE button. For details, see page 34 and 38.
MODE ÉCO.	<ul style="list-style-type: none"> • OUI to turn off the indicators in the display window to conserve the VCR's power. • NON to turn on the indicators in the display window while the VCR is standing by.

FONCTIONS AVANCÉES

Menu option	Set this option to
VPS/PDC PAR DÉFAUT*	<ul style="list-style-type: none"> • NON to deactivate the PDC function. • OUI to activate it.
ÉTENDRE SHOWVIEW*	<ul style="list-style-type: none"> • NON to deactivate the ShowView Extend function. • 10/20/30/60 (minutes) to extend the time of the ShowView setting by the selected amount of time.
VEILLE AUTO	<ul style="list-style-type: none"> • NON to deactivate the Auto Power Off function. • 2HEURES/3HEURES to turn the VCR off automatically if no signal is received and you do not press any of the buttons during this time.

* SLV-SE210B only

Editing with another VCR

How to connect to record on this VCR

Connect the line outputs of the other VCR to the input connector of this VCR. Refer to the examples A or B and choose the connection that best suits your VCR.

Example A

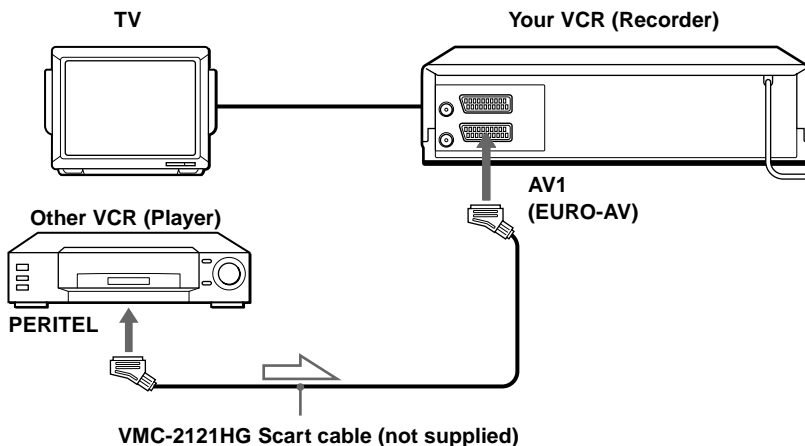

Example B (SLV-SE210B only)

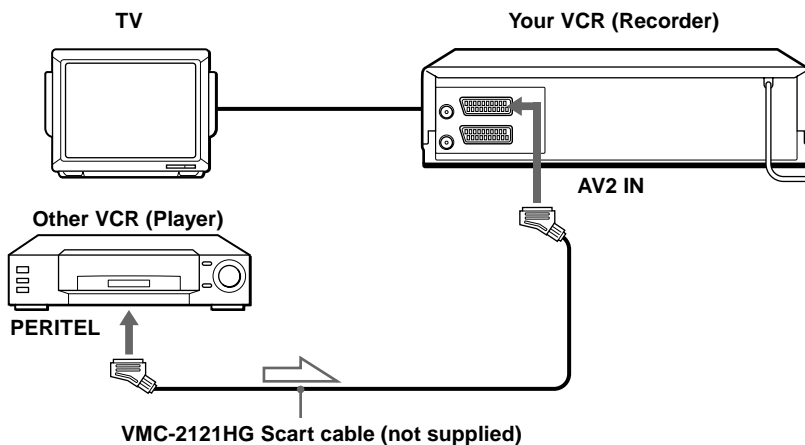

Note

- If the other VCR does not have a PERITEL connector, use the VMC-2106HG cable instead and connect the cable to the line out jacks of the other VCR.

Operation (when recording on this VCR)

Before you start editing

- Turn on your TV and set it to video input.
- Press CHOIX ENTREE to display the connected line in the display window.

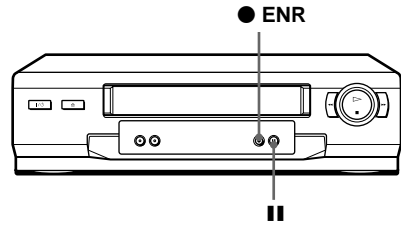

- 1** Insert a source tape with its safety tab removed into the other (playback) VCR. Search for the point to start playback and set it to playback pause.
- 2** Insert a tape with its safety tab in place into this (recording) VCR. Search for the point to start recording and press **||** (pause).
- 3** Press **● ENR** on this VCR to set it to recording pause.
- 4** To start editing, press the **||** (pause) buttons on both VCRs at the same time.

To stop editing

Press the **■** (stop) buttons on both VCRs.

Tip

- To cut out unwanted scenes while editing, press **||** (pause) on this VCR when an unwanted scene begins. When it ends, press **||** (pause) again to resume recording.

Troubleshooting

If you have any questions or problems not covered below, please consult your nearest Sony service facility.

	Symptom	Remedy
Power	The I/⏻ (on/standby) switch does not function.	<ul style="list-style-type: none"> Connect the mains lead to the mains securely.
	The power is turned on but the VCR does not operate.	<ul style="list-style-type: none"> Moisture condensation has occurred. Turn the power off, unplug the mains lead and leave the VCR to dry for over three hours.
Clock	The clock has stopped and “--:--” appears in the display window.	<ul style="list-style-type: none"> The clock stops if the VCR is disconnected from the mains for more than one hour. Reset the clock (and timer).
Playback	The playback picture does not appear on the TV screen.	<ul style="list-style-type: none"> Make sure the TV is set to video input. Make sure the VCR indicator is lit in the display window. Use the TV/MAGN button on the remote commander to light up the VCR indicator.
	The picture is not clear.	<ul style="list-style-type: none"> Adjust the tracking with the CHAINE +/- buttons <u>on the VCR</u>. The video heads are dirty (see the last page of Troubleshooting). Clean the video heads using the Sony T-25CLD, E-25CLDR, or T-25CLW video head cleaning cassette. If these cleaning cassettes are not available in your area, have the heads cleaned at your nearest Sony service facility (a standard service charge will be required). Do not use a commercially available liquid type cleaning cassette other than Sony's, as it may damage the video heads. The video heads may have to be replaced. Consult your local Sony service facility for more information.
	The picture has no colour.	<ul style="list-style-type: none"> The SYST. COULEUR option in the RÉGLAGES UTILISATEUR menu is set to the wrong position. Set the option to conform to the system that the tape was recorded in.
	The picture rolls vertically during picture search.	<ul style="list-style-type: none"> Adjust the vertical hold control on the TV or monitor.
	The picture has no sound.	<ul style="list-style-type: none"> The tape is defective.

	Symptom	Remedy
Recording	No TV programme appears on the TV screen.	<ul style="list-style-type: none"> • Make sure the TV is set to video input. • Select the correct source with the CHOIX ENTREE button. Select a programme position when recording TV programmes; select a line input when recording from other equipment.
	TV reception is poor.	<ul style="list-style-type: none"> • Make sure the aerial cable is connected securely. • Adjust the TV aerial. • Make sure SYS. (L/L' or B/G) in the RECHERCHE MANUELLE menu is set to the same system used in your local area.
	The tape starts playing as soon as it is inserted.	• The safety tab has been removed. To record on this tape, cover the tab hole (see page 32).
	The tape is ejected when you press ● ENR.	• The safety tab has been removed. To record on this tape, cover the tab hole (see page 32).
	Nothing happens when you press ● ENR.	• Make sure the tape is not at its end.
Timer recording	The timer does not operate.	<ul style="list-style-type: none"> • Check that the clock is set. • Make sure a tape has been inserted. • Check that the safety tab has not been removed. • Make sure the tape is not at its end. • Make sure a programme has been set for timer recording. • Make sure your timer settings are past the current time. • Check that the decoder is turned on. • Check that the satellite tuner is turned on. • The clock stops if the VCR is disconnected from the mains for more than one hour. Reset the clock and timer. • Turn the power off and unplug the mains lead.
	The SHOWVIEW menu or the PROG menu does not appear.	• Check that OPTIONS PROG. in the RÉGLAGE UTILISATEUR menu is set correctly (see page 47).
	The PDC function does not operate properly.	<ul style="list-style-type: none"> • Check that the clock and the date are set correctly. • Check that the PDC time you set is the correct one (there might be a mistake in the TV programme guide). If the broadcast you wanted to record did not send the good PDC information, the VCR will not start recording. • If the reception is poor, the PDC signal might be altered and the VCR might not start recording.

	Symptom	Remedy
Canal Plus	You cannot watch the Canal Plus programmes when the VCR is in standby mode.	<ul style="list-style-type: none"> • Make sure the Canal Plus PERITEL cable is plugged securely.
	A Canal Plus programme is always recorded scrambled.	<ul style="list-style-type: none"> • Make sure the Canal Plus PERITEL cable is plugged securely. • Check that DECODEUR is set to OUI for this channel in the RECHERCHE MANUELLE menu (see page 26).
Others	A tape cannot be inserted.	<ul style="list-style-type: none"> • Check that a tape isn't already in the tape compartment.
	The remote commander does not function.	<ul style="list-style-type: none"> • Make sure you are pointing the remote commander at the remote sensor on the VCR. • Replace all the batteries in the remote commander with new ones if they are weak. • Make sure the TV / MAGN remote control switch is set correctly.
	The tracking meter does not appear on the TV screen.	<ul style="list-style-type: none"> • The recording condition of the tape is very poor and tracking cannot be adjusted.
	The display window becomes dim.	<ul style="list-style-type: none"> • The display window automatically becomes dim when the VCR is in standby or timer recording mode.
	The VCR needs to be cleaned.	<ul style="list-style-type: none"> • Clean the cabinet, panel and controls with a dry, soft cloth, or a soft cloth slightly moistened with a mild detergent solution. Do not use any type of solvent, such as alcohol or benzine.

Symptoms caused by contaminated video heads

• Normal picture

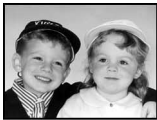

• Rough picture

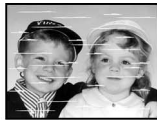

initial
contamination

• Unclear picture



• No picture (or black & white screen appears)



terminal



Specifications

System

Channel coverage

SECAM (L):

VHF F2 to F10

UHF F21 to F69

CATV B to Q

HYPER S21 to S41

PAL (B/G)

VHF E2 to E12

VHF Italian channel A to H

UHF E21 to E69

CATV S01 to S05, S1 to S20

HYPER S21 to S41

Aerial out

75-ohm asymmetrical aerial socket

Tape speed

SP: PAL 23.39 mm/s
(recording/playback)

SECAM

23.39 mm/s
(recording/playback)

MESECAM

23.39 mm/s
(recording/playback)

NTSC 33.35 mm/s

(playback only)

Maximum recording/playback time

5 hrs. in SP mode (with E300 tape)

Rewind time

Approx. 60 sec. (with E180 tape)

Inputs and outputs

AV1 (EURO AV)

21-pin

Video input: pin 20

Audio input: pins 2 and 6

Video output: pin 19

Audio output: pins 1 and 3

AV2 IN (SLV-SE210B only)

21-pin

Video input: pin 20

Audio input: pins 2 and 6

General

Power requirements

230 V AC, 50 Hz

Power consumption

15 W

3 W (MODE ÉCO. is set to OUI,
Standby mode)

Operating temperature

5°C to 40°C

Storage temperature

-20°C to 60°C

Dimensions

Approx. 360 × 94 × 255 mm (w/h/d)
including projecting parts and controls

Mass

Approx. 2.6 kg

Supplied accessories

Remote commander (1)

R6 (size AA) batteries (2)

Aerial cable (1)

PERITEL cable (1)

Design and specifications are subject to
change without notice.

Index

A

- Adjusting
 - picture 45
 - tracking 45
- Aerial hookup 12
- Auto Set Up 13

C

- Canal Plus 26
- Changing the programme position 21
- Changing the station name 24
- Cleaning the video heads 50
- Clock setting 15
- Colour system
 - compatible colour systems 2
- Connecting
 - the VCR and your TV 12
 - to a TV with a PERITEL connector 12
- Counter 30

D

- Disabling the programme positions 22
- Dubbing. *see* Editing

E

- Editing 48

L

- Language selecting 17

O

- Optional setting 46

P

- PDC (Programme Delivery Control) 36
- PERITEL connection 12
- Playback 29
 - at various speeds 41
 - frame-by-frame 41
 - slow motion 41
- Presetting channels 18

R

- Recording 31
 - duration time 42
 - saving 32
 - timer setting 38
 - using the ShowView system 34
 - while watching another programme 32

S

- Safety tab 32
- Searching
 - at various speeds 41
- ShowView
 - recording 34

T

- Timer setting 38
 - cancelling 43
 - changing 43
 - checking 43
 - daily/weekly recording 36, 39
 - using the ShowView system 34

Quick Start Guide

1 Connecting the VCR

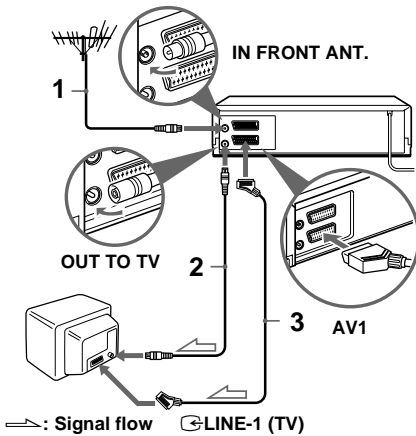

- 1... Connect the aerial to IN FRONT ANT. of the VCR.
- 2... Connect OUT TO TV and the aerial input of your TV using the supplied aerial cable.
- 3... Connect AV1 (EURO AV) to your TV using the supplied PERITEL cable.

2 Using the Auto Set Up function

- 1 ...Turn on your TV and set it to video input.
- 2 ...Connect the mains lead to the mains.
- 3 ...Press OK.
- 4 ...Press **↑/↓/←/→** to select your country, then press OK.

When all of the receivable channels are preset, the menu disappears from the TV screen. You can rearrange the programme position in any order (see “Changing/disabling programme positions”).

After the search or download is complete, the current time appears automatically. If the time does not appear, set the clock manually. See “Setting the clock.”

Now you can operate your VCR.