

# *Video Cassette Recorder*

---

Operating Instructions



**SLV-EZ44AZ/EZ22AZ** **G-CODE®**  
**SLV-EZ11AZ**

## WARNING

To prevent fire or shock hazard, do not expose the unit to rain or moisture.

To avoid electrical shock, do not open the cabinet. Refer servicing to qualified personnel only.

The mains lead must only be changed at a qualified service shop.

## Precautions

### Safety

- This unit operates on 220-240 V AC, 50 Hz. Check that the unit's operating voltage is identical with your local power supply.
- If anything falls into the cabinet, unplug the unit and have it checked by qualified personnel before operating it any further.
- The unit is not disconnected from the mains as long as it is connected to the mains, even if the unit itself has been turned off.
- Unplug the unit from the mains if you do not intend to use it for an extended period of time. To disconnect the lead, pull it out by the plug, never by the lead.

### Installing

- Allow adequate air circulation to prevent internal heat buildup.
- Do not place the unit on surfaces (rugs, blankets, etc.) or near materials (curtains, draperies) that may block the ventilation slots.
- Do not install the unit near heat sources such as radiators or air ducts, or in a place subject to direct sunlight, excessive dust, mechanical vibration or shock.
- Do not install the unit in an inclined position. It is designed to be operated in a horizontal position only.
- Keep the unit and cassettes away from equipment with strong magnets, such as microwave ovens or large loudspeakers.
- Do not place heavy objects on the unit.
- If the unit is brought directly from a cold to a warm location, moisture may condense inside the VCR and cause damage to the video head and tape. When you first install the unit, or when you move it from a cold to a warm location, wait for about four hours before operating the unit.

## Caution

Television programmes, films, video tapes and other materials may be copyrighted.

Unauthorized recording of such material may be contrary to the provisions of the copyright laws. Also, use of this recorder with cable television transmission may require authorization from the cable television transmitter and/or programme owner.

## Compatible colour systems

- This VCR is designed to record and play back using the PAL (B/G) colour system. Recording of video sources based on other colour systems cannot be guaranteed.
- Tapes recorded with NTSC colour system can be played back on this VCR using a TV or a colour monitor for the PAL colour system.

# Table of contents

## Getting Started

- 4 Step 1: Unpacking
- 5 Step 2: Setting up the remote commander
- 8 Step 3: Connecting the VCR
- 10 Step 4: Tuning your TV to the VCR
- 12 Step 5: Setting the clock
- 14 Step 6: Presetting channels with the EASY G-CODE SET UP function (SLV-EZ44AZ/EZ22AZ only)
- 16 Presetting channels
- 23 Setting up the G-CODE\* system manually (SLV-EZ44AZ/EZ22AZ only)
- 26 Changing/disabling programme positions (SLV-EZ44AZ/EZ22AZ only)

## Basic Operations

- 30 Playing a tape
- 34 Recording TV programmes
- 37 Recording TV programmes using the Easy Timer function
- 43 Recording TV programmes using the G-CODE system (SLV-EZ44AZ/EZ22AZ only)
- 46 Setting the timer manually

## Additional Operations

- 48 Playing/searching at various speeds
- 49 Setting the recording duration time
- 50 Checking/changing/cancelling timer settings
- 52 Searching the beginning of an Easy Timer recorded programme

- 53 Searching using the index function
- 55 Adjusting the picture
- 56 Changing menu options
- 57 Editing with another VCR

## Additional Information

- 59 Troubleshooting
- 62 Specifications
- 63 Index to parts and controls
- Back cover
- Index

\* G-CODE is a registered trademark of Gemstar Development Corporation. The G-CODE system is manufactured under license from Gemstar Development Corporation.

# Step 1

## Unpacking

Check that you have received the following items with the VCR:

- Remote commander

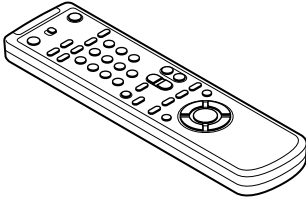

- Aerial cable

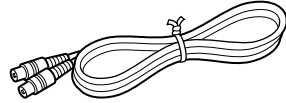

- R6 (size AA) batteries

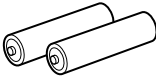

### Checking your model name

The instructions in this manual are for the 3 models : SLV-EZ44AZ, EZ22AZ and EZ11AZ. Check your model number by looking at the rear panel of your VCR. The SLV-EZ44AZ is the model used for illustration purposes. Any difference in operation is clearly indicated in the text, for example, "SLV-EZ44AZ only."

## Step 2

# Setting up the remote commander

### Inserting the batteries

Insert two R6 (size AA) batteries by matching the + and - on the batteries to the diagram inside the battery compartment.

Insert the negative (-) end first, then push in and down until the positive (+) end clicks into position.

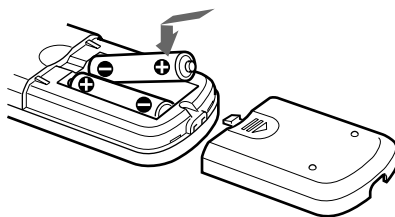

### Using the remote commander

You can use this remote commander to operate this VCR and a Sony TV. Buttons on the remote commander marked with a dot (•) can be used to operate your Sony TV. If the TV does not have the  symbol near the remote sensor, this remote commander will not operate the TV.

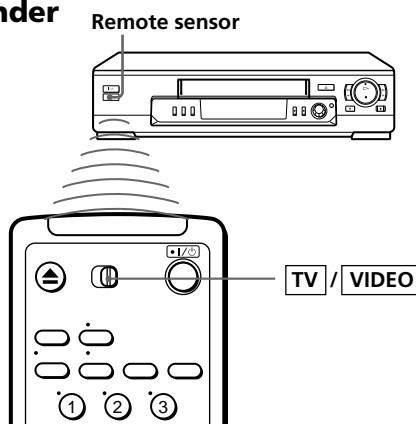

To operate	Set <b>TV</b> / <b>VIDEO</b> to
the VCR	<b>VIDEO</b> and point at the remote sensor on the VCR
a Sony TV	<b>TV</b> and point at the remote sensor on the TV

### Notes

- The TV/VIDEO button selects an input source of the TV from either aerial in or line in. The button does not control this VCR.
- With normal use, the batteries should last about three to six months.
- If you do not use the remote commander for an extended period of time, remove the batteries to avoid possible damage from battery leakage.
- Do not use a new battery with an old one.
- Do not use different types of batteries.

## Step 2: Setting up the remote commander (continued)

### Controlling other TVs with the remote commander (SLV-EZ44AZ/EZ22AZ only)

The remote commander is preprogrammed to control non-Sony TVs. If your TV is listed in the table below, set the appropriate manufacturer's code number.

- 1 Set **TV**/**VIDEO** at the top of the remote commander to **TV**.
- 2 Hold down **I**/**⏻**, and enter your TV's code number(s) using the programme number buttons. Then release **I**/**⏻**.

Now you can use the **I**/**⏻**, **VOL +/-**, **PROG +/-**, programme number buttons, **-/--** (ten's digit) and **TV/VIDEO** buttons to control your TV. You can also use the buttons marked with a dot (•) to control a Sony TV. To control the VCR, reset **TV**/**VIDEO** to **VIDEO**.

#### Code numbers of controllable TVs

If more than one code number is listed, try entering them one at a time until you find the one that works with your TV.

Manufacturer	Code number	Manufacturer	Code number
Sony	01* <sup>1</sup> ,02	Philips	06* <sup>1</sup> ,07* <sup>1</sup> ,08* <sup>1</sup>
Akai	68	Saba	12,13
Blaupunkt	10	Samsung	22,23
Ferguson	52	Sanyo	25
Grundig	11* <sup>1</sup>	Sharp	29
Hitachi	24	Telefunken	36
ITT/Nokia	15,16,69* <sup>3</sup>	Thomson	43* <sup>2</sup>
JVC	33*	Toshiba	38
Loewe	45		
Mivar	09, 70		
NEC	66		
Panasonic	17* <sup>1</sup> ,49		

You can use the WIDE button after entering a code number with any of the following marks;

\*1: Press WIDE to switch the wide picture mode on or off.

\*2: Press WIDE, then press VOL +/- to select the wide picture mode you want.

\*3: Press WIDE. The menu appears on the TV screen. Then, press  $\uparrow/\downarrow/\leftarrow/$   
 $\rightarrow$  to select the wide picture you want and press OK.

#### Notes

- If the TV uses a different remote control system from the one programmed to work with the VCR, you cannot control your TV with the remote commander.
- You may not be able to use some buttons to control non-Sony TVs due to the remote commander's signal limitations.
- If you enter a new code number, the code number previously entered will be erased.
- When you replace the batteries of the remote commander, the code number may automatically reset to 01 (Sony). If your TV is not a Sony, it is recommended to manually set the appropriate code number every time you replace the batteries.
- If you set your TV's code number correctly while the TV is turned on, the TV turns off automatically.

## Step 3

# Connecting the VCR

Connect the aerial to your VCR and TV as shown below to watch TV programmes and VCR pictures on your TV. In addition, if your TV has audio/video (A/V) input jacks, we recommend you connect the VCR to your TV using an audio/video cable to get a better picture and sound.

## Connecting the aerial

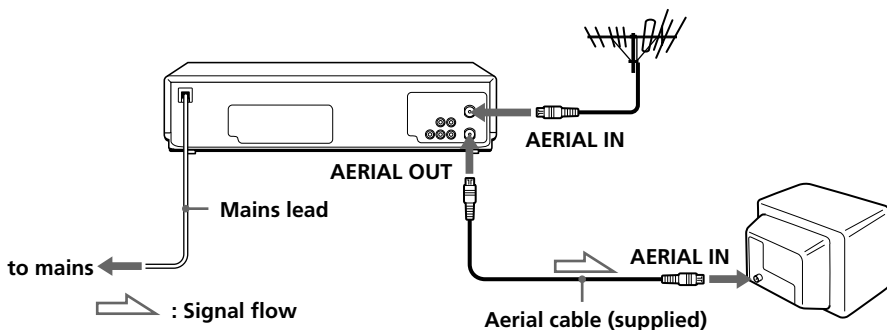

1

Disconnect the aerial cable from your TV and connect it to AERIAL IN on the rear panel of the VCR.

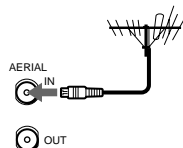

2

Connect AERIAL OUT of the VCR and the aerial input of your TV using the supplied aerial cable.

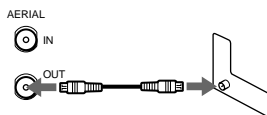

3

Connect the mains lead to the mains.



## Additional connections

### To a TV that has audio/video input jacks

This additional connection improves picture and sound quality. Connect the TV as shown on the right.

If you want to use the Trinitron TV Synchro Play function (see page 33), this connection is necessary. (If your TV has two or more inputs, connect the audio/video cable to the VIDEO IN 1 jacks.)

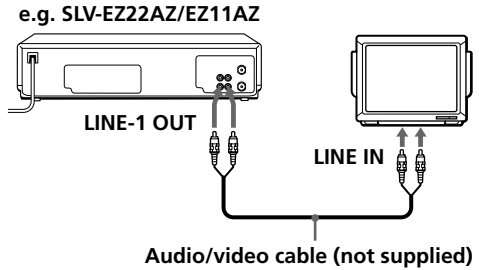
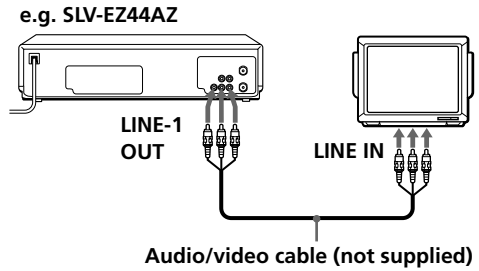

## Step 4

# Tuning your TV to the VCR

If you have connected your VCR to the TV using the audio/video cable, skip this step.

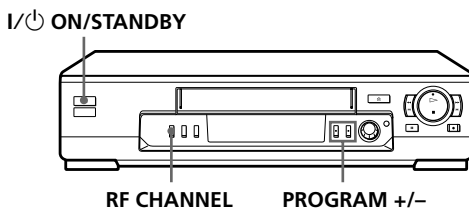

**1**  Press I/ON/STANDBY to turn on the VCR.

**2**  Press RF CHANNEL on the VCR.  
The factory-preset RF channel flashes in the display window for about three seconds.  
Press RF CHANNEL again while the RF channel is flashing.  
The VCR signal is output through this channel to the TV.

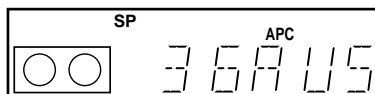

**3**  Press PROGRAM +/- to select the suitable RF channel, depending on the area you live in.  
You can select Australia channels from 28 AUS to 69 AUS or New Zealand channels from 28 NZ to 69 NZ.  
The Australia and New Zealand channels appear in the display window in alternate sequence.

**4** Turn on your TV and select a programme position for the VCR picture.  
This channel will now be referred to as the video channel.  
Some TV has the programme position, such as 0, that is reserved for a VCR. In this case, select that programme position for the VCR picture. Refer to the instruction manual of your TV for details.

---

**5**

Tune the TV to the same channel as that shown in the display window so that the picture on the right appears on the TV screen.

Refer to your TV manual for tuning instructions.

If the picture does not appear clearly, see "To obtain a clear picture from the VCR" below.



SONY VIDEO CASSETTE  
RECORDER

---

**6**

RF CHANNEL

Press RF CHANNEL.

You have now tuned your TV to the VCR. From now on, whenever you want to play a tape, set the TV to the video channel.

---

### To obtain a clear picture from the VCR

If the picture does not appear clearly in step 5 above, press PROGRAM +/- in step 5, so that another RF channel appears. Then tune the TV to the new RF channel until a clear picture appears.

To set another RF channel number on the VCR, select a channel number that does not receive a broadcast signal in your area and is clear of interference from other channels.

If you cannot obtain a clear picture after performing this procedure, we recommend you connect the VCR and TV using an audio/video cable (see "To a TV that has audio/video input jacks" on page 9). If the same symptom persists, consult your nearest Sony dealer.

## Step 5

# Setting the clock

You must set the time and date on the VCR to be able to use the timer recording features properly.

### Before you start...

- Turn on your TV and set it to the video channel.

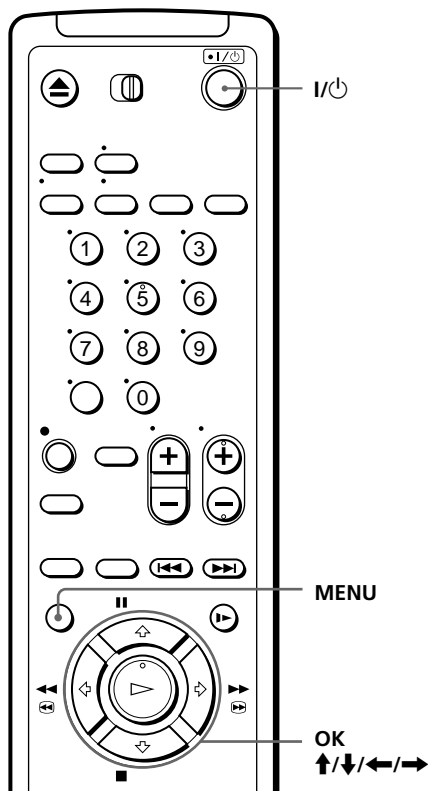

- 1** Press I/⏻ (on/standby) to turn on the VCR.



- 2** Press MENU, then press **↑/↓** to move the cursor (▶) to CLOCK SET and press OK.

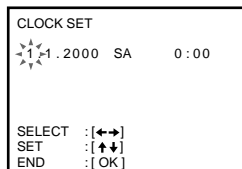

3



Press  $\uparrow/\downarrow$  to set the date.  
The day of the week is set automatically.

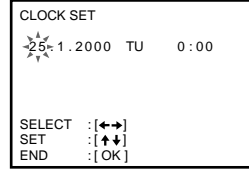

4



Press  $\rightarrow$  to flash the month and set the month using  $\uparrow/\downarrow$ .

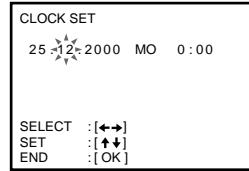

5



Set the year, hour and minute in sequence, using  $\rightarrow$  to flash the item to be set, and  $\uparrow/\downarrow$  to select the digits.

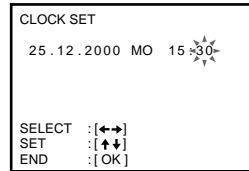

6



Press OK to start the clock.

#### Tip

- To change the digits during setting, press  $\leftarrow$  to return to the item to be changed, and select the digits using  $\uparrow/\downarrow$ .

#### Note

- The menu disappears automatically if you do not proceed for more than a few minutes.

## Step 6

# Presetting channels with the EASY G-CODE SET UP function (SLV-EZ44AZ/EZ22AZ only)

The EASY G-CODE SET UP function is a feature that simplifies the channel presetting and the G-CODE guide channel setting. Just choose your local area in the EASY G-CODE SET UP menu, and the VCR will automatically preset the TV channels and the G-CODE guide channels for your area.

At the factory the VCR has been preset for Sydney. If you live in this area, you can use the VCR without setting the channels and G-CODE system.

### Before you start...

- Turn on the VCR and the TV.
- Set the TV to the video channel.

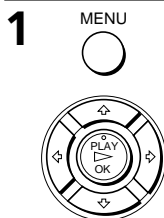
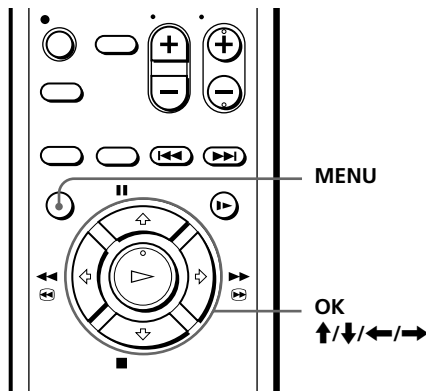

1 Press MENU, then press **↑/↓** to move the cursor (▶) to EASY G-CODE SET UP and press OK.

EASY G-CODE SET UP	PAGE
CITY / AREA SELECT	1 / 4
▶SYDNEY	
MELBOURNE	
BRISBANE	
PERTH	
ADELAIDE	
SELECT : [↑↓]	
NZ : [←→]	
SET : [OK]	



2 Press **←/→** to display the local areas of either AUS (Australia) or NZ (New Zealand), depending on the country you live in.

EASY G-CODE SET UP	PAGE
CITY / AREA SELECT	1 / 3
▶AUCKLAND	
WAIKATO	
ROTORUA	
BAY OF PLENTY	
HAWKES BAY	
SELECT : [↑↓]	
AUS : [←→]	
SET : [OK]	



3 Press **↑/↓** to move the cursor (▶) to your local area, then press OK to confirm the setting. To display other pages for areas, press **↑/↓** repeatedly.

The TV channels and G-CODE guide channels for your local area are set up automatically.

**To check if the channels are preset correctly**

Set the TV to the video channel and press PROGRAM +/- on the VCR. If the TV screen changes to a different programme each time you press PROGRAM +/-, the channels are preset correctly.

**To check the guide channel setting**

Press MENU, then press **↑/↓** to move the cursor (**▶**) to SET UP CH AND G-CODE and press OK. The guide channels for your local area are displayed on the screen.

**Tips**

- If your area is not listed in the EASY G-CODE SET UP menu, preset the TV channels using the One Touch Tuning function or the TUNER PRESET menu (see "Presetting channels" on page 16). Then set up the G-CODE guide channels manually if you want to record TV programmes using the G-CODE numbers (see "Setting up the G-CODE system manually" on page 23).
- If you want to record satellite broadcast using the G-CODE numbers, see page 25.

# Presetting channels

(For SLV-EZ44AZ/EZ22AZ only)

If you can receive no channels or only a few channels after performing the EASY G-CODE SET UP function (page 14), preset all receivable channels automatically using the One Touch Tuning function or the TUNER PRESET menu.

If some channels could not be preset automatically when using the EASY G-CODE SET UP function, One Touch Tuning function or TUNER PRESET menu, preset them manually; if there are any unwanted channels among the preset ones, you can disable the channels.

(For SLV-EZ11AZ only)

First, we recommend that you preset the receivable channels in your area using the One Touch Tuning function or the AUTO PRESET in the TUNER PRESET menu. Then, if some channels could not be preset automatically, set them manually; if there are any unwanted channels among the preset ones, you can disable the channels.

## Presetting all receivable channels using the One Touch Tuning function

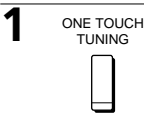
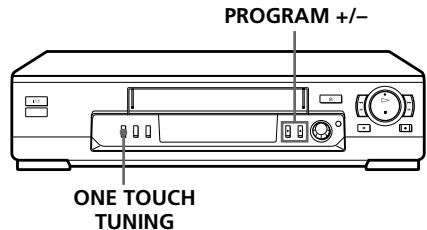

Press and hold ONE TOUCH TUNING on the VCR for more than three seconds.

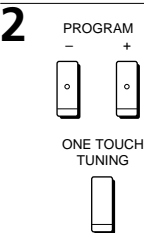

**1** Press PROGRAM +/- on the VCR so that the indicator for your country (AUS or NZ) appears in the display window.

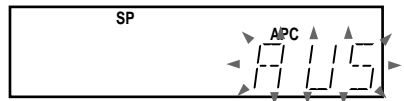

**2** Press ONE TOUCH TUNING.

The VCR starts presetting the channels.



The WAIT indicator goes off when all the receivable channels are preset.



**To check if the channels are preset correctly**

Set the TV to the video channel and press PROGRAM +/- on the VCR. If the TV screen changes to a different programme each time you press PROGRAM +/-, the channels are preset correctly.

**Tip**

- To stop the One Touch Tuning function, press ONE TOUCH TUNING or ■ STOP on the VCR during the setting.

continued

## Presetting channels (continued)

### Presetting all receivable channels automatically

#### Before you start...

- Turn on the VCR and the TV.
- Set the TV to the video channel.

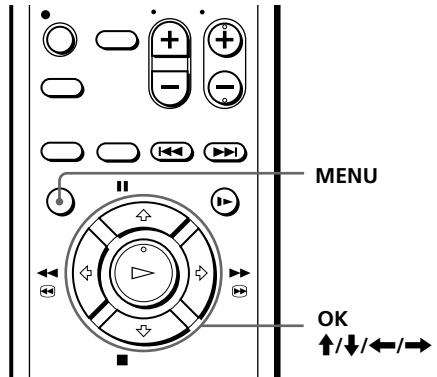

1



Press MENU, then press **↑/↓** to move the cursor (▶) to TUNER PRESET and press OK.

TUNER PRESET	PROG 1
COUNTRY	•AUS NZ
NORMAL / CATV	•NORM CATV
AUTO PRESET	
▶CHANNEL SET	1
ADD / ERASE	•ADD ERASE
AFT	•ON OFF
FINE TUNING	
SELECT : [↑↓]	
SET : [←→]	

2



Press **↑/↓/←/→** to move the cursor (▶) to COUNTRY, then select either AUS (Australia) or NZ (New Zealand), depending on the country you live in.

TUNER PRESET	PROG 1
▶COUNTRY	•AUS NZ
NORMAL / CATV	•NORM CATV
AUTO PRESET	
CHANNEL SET	1
ADD / ERASE	•ADD ERASE
AFT	•ON OFF
FINE TUNING	
SELECT : [↑↓]	
SET : [←→]	

3



Press **↑/↓/←/→** to move the cursor (▶) to NORMAL/CATV, then select NORM.  
To preset CATV channels, select CATV.

TUNER PRESET	PROG 1
COUNTRY	•AUS NZ
▶NORMAL / CATV	•NORM CATV
AUTO PRESET	
CHANNEL SET	1
ADD / ERASE	•ADD ERASE
AFT	•ON OFF
FINE TUNING	
SELECT : [↑↓]	
SET : [←→]	

4



Press **↑/↓** to move the cursor (**▶**) to **AUTO PRESET**, then press **OK**.

All receivable channels are preset in numerical sequence. When no more receivable channels can be found, presetting stops and the picture from the lowest numbered channel is displayed on the TV screen.

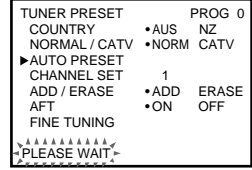

**continued**

## Presetting channels (continued)

### Presetting channels manually

#### Before you start...

- Turn on the VCR and the TV.
- Set the TV to the video channel.

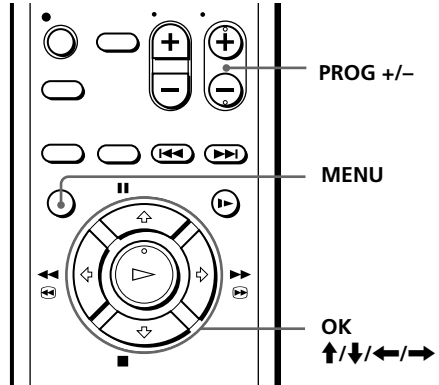

- 1** Press MENU, then press **↑/↓** to move the cursor (▶) to TUNER PRESET and press OK.



TUNER PRESET	PROG10
COUNTRY	•AUS NZ
NORMAL / CATV	•NORM CATV
AUTO PRESET	
▶CHANNEL SET	21
ADD / ERASE	•ADD ERASE
AFT	•ON OFF
FINE TUNING	
SELECT : [↑↓]	
SET : [←→]	

- 2** Press **↑/↓/←/→** to move the cursor (▶) to COUNTRY, then select either AUS (Australia) or NZ (New Zealand), depending on the country you live in.



TUNER PRESET	PROG10
▶COUNTRY	•AUS NZ
NORMAL / CATV	•NORM CATV
AUTO PRESET	
CHANNEL SET	21
ADD / ERASE	•ADD ERASE
AFT	•ON OFF
FINE TUNING	
SELECT : [↑↓]	
SET : [←→]	

- 3** Press **↑/↓/←/→** to move the cursor (▶) to NORMAL/CATV, then select NORM. To preset CATV channels, select CATV.



TUNER PRESET	PROG10
COUNTRY	•AUS NZ
▶NORMAL / CATV	•NORM CATV
AUTO PRESET	
CHANNEL SET	21
ADD / ERASE	•ADD ERASE
AFT	•ON OFF
FINE TUNING	
SELECT : [↑↓]	
SET : [←→]	

- 4** Press **↑/↓** to move the cursor (▶) to CHANNEL SET.



TUNER PRESET	PROG10
COUNTRY	•AUS NZ
NORMAL / CATV	•NORM CATV
AUTO PRESET	
▶CHANNEL SET	21
ADD / ERASE	•ADD ERASE
AFT	•ON OFF
FINE TUNING	
SELECT : [↑↓]	
SET : [←→]	

5

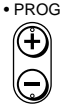

Press PROG +/- to select the programme position.

**Selected programme position**

TUNER PRESET		PROG14
COUNTRY	•AUS NZ	
NORMAL / CATV	•NORM CATV	
AUTO PRESET		
▶CHANNEL SET	21	
ADD / ERASE	•ADD ERASE	
AFT	•ON OFF	
FINE TUNING		
SELECT	: [↑↓]	
SET	: [←→]	

6



Press **→** repeatedly until the channel you want is displayed. Pressing **←** goes back to the previous channels.

The channels are scanned in the following order:

TUNER PRESET		PROG14
COUNTRY	•AUS NZ	
NORMAL / CATV	•NORM CATV	
AUTO PRESET		
▶CHANNEL SET	35	
ADD / ERASE	•ADD ERASE	
AFT	•ON OFF	
FINE TUNING		
SELECT	: [↑↓]	
SET	: [←→]	

Channel coverage	COUNTRY is set to AUS	COUNTRY is set to NZ
VHF	AS0 to AS12, AS5A, AS9A	NZ1 to NZ11
UHF	AS28 to AS69	E21 to E69
CATV (TV distribution)	S1 to S41, S01 to S05	S1 to S41, S01 to S05

If you know the number of the channel you want, press the programme number buttons. For example, for channel 5, first press "0" and then press "5". To set channel 5A or 9A, press **→** after pressing "0" and "5" or "0" and "9" (When COUNTRY is set to AUS).

7

To allocate another channel to another programme position, repeat steps 5 and 6.

8



Press OK.

**continued**

## Presetting channels (continued)

### Disabling unwanted programme positions

After presetting channels, you can disable unused programme positions. The disabled positions will be skipped later when you press the PROG +/- buttons. (For SLV-EZ44AZ/EZ22AZ only) You can also disable unwanted programme positions using the SET UP CH AND G-CODE menu (page 28).

- 1 Press MENU, then press  $\uparrow/\downarrow$  to move the cursor ( $\blacktriangleright$ ) to TUNER PRESET and press OK.
- 2 Press PROG +/- to select the programme position you want to skip.
- 3 Press  $\uparrow/\downarrow/\leftarrow/\rightarrow$  to move the cursor ( $\blacktriangleright$ ) to ADD/ERASE, then select ERASE.
- 4 Press OK.

### If the picture is not clear

Normally, the Auto Fine Tuning (AFT) function automatically tunes in channels clearly. If, however, the picture is not clear, you may also use the manual tuning function.

- 1 Press PROG +/- to select the programme number for which you cannot obtain a clear picture.
- 2 Press MENU, then select TUNER PRESET and press OK.
- 3 Select FINE TUNING.

The fine tuning meter appears.

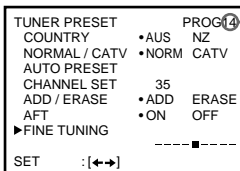

Selected programme position

- 4 Press  $\leftarrow/\rightarrow$  to get a clearer picture, then press OK.

Note that the AFT (Auto Fine Tuning) setting switches to OFF.

### Notes

- The menu disappears automatically if you do not proceed for more than a few minutes.
- The channel numbers besides CHANNEL SET may not be the same as those in your area. This is because this VCR's channel search system is based on the fixed TV system that has the widest channel coverage. If necessary, apply your local channel numbers to the programme positions (see "Changing programme positions" on page 26).

# Setting up the G-CODE system manually (SLV-EZ44AZ/EZ22AZ only)

The G-CODE system is a feature in Sony VCRs that simplifies programming the VCR to make timer recordings.

First, we recommend that you set up the G-CODE guide channels for your area using the EASY G-CODE SET UP function (page 14). If your area is not listed in the EASY G-CODE SET UP menu, preset the TV channels (page 16) and then set up the guide channels manually. To get the guide channel numbers, look in the programme guide for your area that features G-CODE numbers.

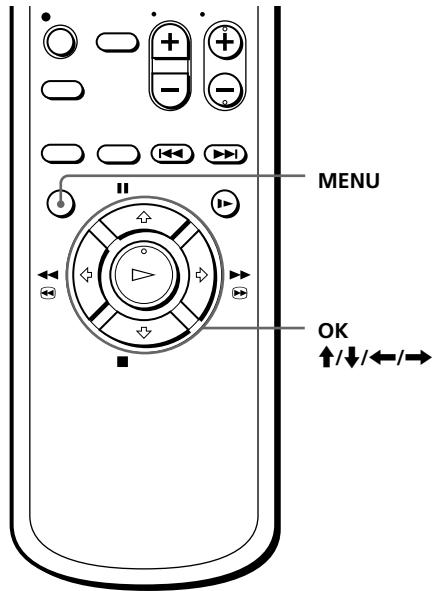

## Before you start...

- Turn on the VCR and the TV.
- Set the TV to the video channel.

1



Press MENU, then press **↑/↓** to move the cursor (▶) to SET UP CH AND G-CODE and press OK.

The preset channels are displayed on the screen.

e.g. COUNTRY is set to AUS

SET UP CH AND G-CODE			
PROG	CH	GUIDE	CH
▶ 0	2	-	----
1	7	-	----
2	9	-	----
3	10	-	----
4	28	-	----
SELECT	:[↑↓]		
MOVE PROG	:[▶]		
ERASE PROG	:[CLEAR]		

2



Press **↑/↓** to move the cursor (▶) to the row on which you want to set the guide channel.

To display other pages for programme positions 5 to 49 (for Australia) or 6 to 50 (for New Zealand), press **↑/↓** repeatedly.

SET UP CH AND G-CODE			
PROG	CH	GUIDE	CH
0	2	-	----
1	7	-	----
▶ 2	9	-	----
3	10	-	----
4	28	-	----
SELECT	:[↑↓]		
MOVE PROG	:[▶]		
ERASE PROG	:[CLEAR]		

**continued**

## Setting up the G-CODE system manually (continued)

3



Press **→** twice to flash the guide channel column.

SET UP CH AND G-CODE			
PROG	CH	GUIDE	CH
0	2	---	---
1	7	----	----
▶ 2	9	----	----
3	10	----	----
4	28	----	----
SELECT GUIDE CH			: [↑↓]
CONFIRM			: [←→]

4



Press **↑/↓** to select the guide channel number assigned in the programme guide.

SET UP CH AND G-CODE			
PROG	CH	GUIDE	CH
0	2	---	---
1	7	----	----
▶ 2	9	----	9
3	10	----	----
4	28	----	----
SELECT GUIDE CH			: [↑↓]
CONFIRM			: [←→]

5



Press **←/→** to confirm the setting.

The cursor (▶) appears in the leftmost column.

SET UP CH AND G-CODE			
PROG	CH	GUIDE	CH
0	2	---	---
1	7	----	----
▶ 2	9	----	9
3	10	----	----
4	28	----	----
SELECT			: [↑↓]
MOVE PROG			: [→]
ERASE PROG			: [CLEAR]

6

To set the guide channel of another station, repeat steps 2 to 5.

If you want to change the programme positions of the stations, proceed to step 2 of “Changing/disabling programme positions” on page 26.

7



Press **OK**.



## Setting up the G-CODE system for satellite broadcasts (if applicable)

When your satellite tuner is connected via the AERIAL IN connector, first you have to set the programme position for each satellite channel using the TUNER PRESET menu. Then set the guide channel number for each satellite channel using the SET UP CH AND G-CODE menu.

If your satellite tuner is connected via the LINE-1 IN jacks, you do not have to set programme positions nor guide channel numbers for satellite channels. Skip the following operations.

- 1 Turn on the satellite tuner.
- 2 Press MENU, then select TUNER PRESET and press OK.
- 3 Press  $\uparrow/\downarrow/\leftarrow/\rightarrow$  to select AUS or NZ, depending on the country you live in.
- 4 Press PROG +/- to select a programme position you want to use for watching a satellite channel.

- 5 Select CHANNEL SET, then press  $\rightarrow$  to tune the VCR to the satellite tuner.

The channel number displayed beside CHANNEL SET is used for receiving all satellite broadcasts from the satellite tuner.

TUNER PRESET	•AUS	•NORM	PROG 6
COUNTRY	NZ	CATV	
NORMAL / CATV			
AUTO PRESET			
▶CHANNEL SET	30		
ADD / ERASE	•ADD	ERASE	
AFT	•ON	OFF	
FINE TUNING			
SELECT	: [ $\uparrow$ $\downarrow$ ]		
SET	: [ $\leftarrow$ $\rightarrow$ ]		

- 6 Press PROG +/- to select another programme position for another satellite channel, and press the programme number buttons to enter the same channel number as the one displayed in step 5.

Repeat this step for all satellite channels.

- 7 Set the guide channel number for each programme position assigned to the satellite channel, following the procedures in "Setting up the G-CODE system manually" on page 23.

### Notes

- The menu disappears automatically if you do not proceed for more than a few minutes.
- If you inadvertently entered a guide channel number, press  $\uparrow/\downarrow$  repeatedly to reset the "GUIDE CH" column to "----". "----" appears between 1 and 255.
- The VCR does not allow entering the guide channel number, if the same number has been set.
- If you use a satellite tuner connected via the LINE-1 IN jacks, you do not have to set up the G-CODE guide channels. Just record a satellite programme using the G-CODE number, and the VCR automatically records the programme from the LINE-1 IN jacks.
- When you record a satellite broadcast using the G-CODE number, you need to select the desired channel on the satellite tuner manually.

# Changing/ disabling programme positions (SLV- EZ44AZ/EZ22AZ only)

After setting the channels and G-CODE guide channels, you can change the programme positions as you like. If any programme positions are unused or contain unwanted channels, you can disable them.

## Before you start...

- Turn on the VCR and the TV.
- Set the TV to the video channel.

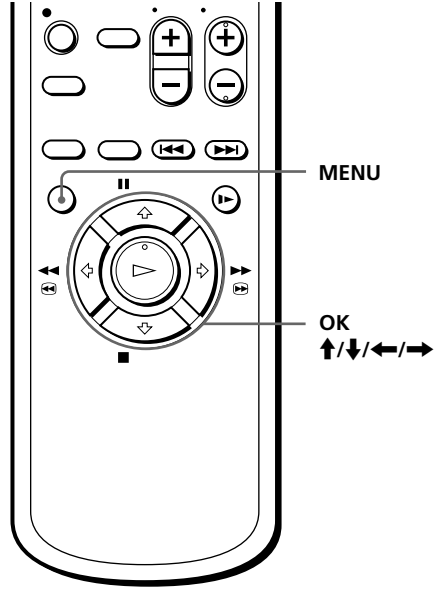

## Changing programme positions

e.g. Moving the programme position from 2 to 0.

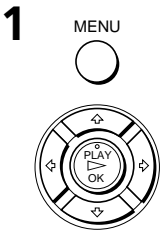

Press MENU, then press **↑/↓** to move the cursor (▶) to SET UP CH AND G-CODE and press OK.

e.g. COUNTRY is set to AUS

SET UP CH AND G-CODE	PROG	CH	GUIDE	CH
▶	0	2	-	2
	1	7	-	7
	2	9	-	9
	3	10	-	10
	4	28	-	28
SELECT	:[↑↓]			
MOVE PROG	:[→]			
ERASE PROG	:[CLEAR]			



Press **↑/↓** to move the cursor (▶) to the row on which you want to change the programme position, then press **→**.

To display other pages for programme positions 5 to 49 (for Australia) or 6 to 50 (for New Zealand), press **↑/↓** repeatedly.

SET UP CH AND G-CODE	PROG	CH	GUIDE	CH
	0	2	-	2
▶	2	9	-	9
	3	10	-	10
	4	28	-	28
SELECT	:[↑↓]			
SET GUIDE CH	:[→]			
CONFIRM	:[↵]			

3



Press **↑/↓** until the selected channel and guide channel row moves to the desired programme position.

The selected channel and guide channel are inserted at the new programme position and the intermediate channels are displaced to fill the gap.

SET UP CH AND G-CODE			
PROG	CH	GUIDE	CH
▶ 0	9	9	
1	2	2	
2	7	7	
3	10	10	
4	28	28	
SELECT	: [↑↓]		
SET GUIDE CH	: [→]		
CONFIRM	: [←]		

4



Press **←** to confirm the setting.

5

To change the programme position of another station, repeat steps 2 to 4.

6



Press **OK**.

continued

## Changing/disabling programme positions (continued)

### Disabling unwanted programme positions

#### Note

- Be sure to select the programme position you want to disable correctly. If you disable a programme position by mistake, you need to reset that channel manually.

#### Before you start...

- Turn on the VCR and the TV.
- Set the TV to the video channel.

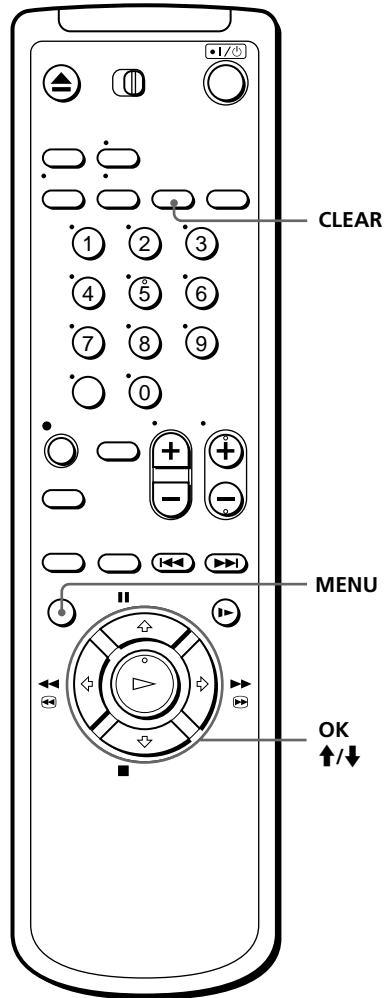

1

MENU



Press MENU, then press  $\uparrow/\downarrow$  to move the cursor ( $\blacktriangleright$ ) to SET UP CH AND G-CODE and press OK.

SET UP CH AND G-CODE			
PROG	CH	GUIDE	CH
$\blacktriangleright$ 0	2	-	2
1	7	-	7
2	9	-	9
3	10	-	10
4	28	-	28
SELECT	:[ $\uparrow/\downarrow$ ]		
MOVE PROG	:[ $\rightarrow$ ]		
ERASE PROG	:[CLEAR]		

2



Press **↑/↓** to move the cursor (**▶**) to the row on which you want to disable.

To display other pages for programme position 5 to 49 (for Australia) or 6 to 50 (for New Zealand), press **↑/↓** repeatedly.

SET UP CH AND G-CODE			
PROG	CH	GUIDE	CH
0	2	-	2
1	7	-	7
▶ 2	9	-	9
3	10	-	10
4	28	-	28
SELECT		:[ <b>↑↓</b> ]	
MOVE PROG		:[ <b>▶</b> ]	
ERASE PROG		:[ <b>CLEAR</b> ]	

3



Press **CLEAR**.

The selected row will be cleared as shown on the right.

SET UP CH AND G-CODE			
PROG	CH	GUIDE	CH
0	2	-	2
1	7	-	7
▶ 2	--	--	--
3	10	-	10
4	28	-	28
SELECT		:[ <b>↑↓</b> ]	
MOVE PROG		:[ <b>▶</b> ]	
ERASE PROG		:[ <b>CLEAR</b> ]	

4

Repeat steps 2 and 3 for any other programme positions you want to disable.

5



Press **OK**.

# Playing a tape

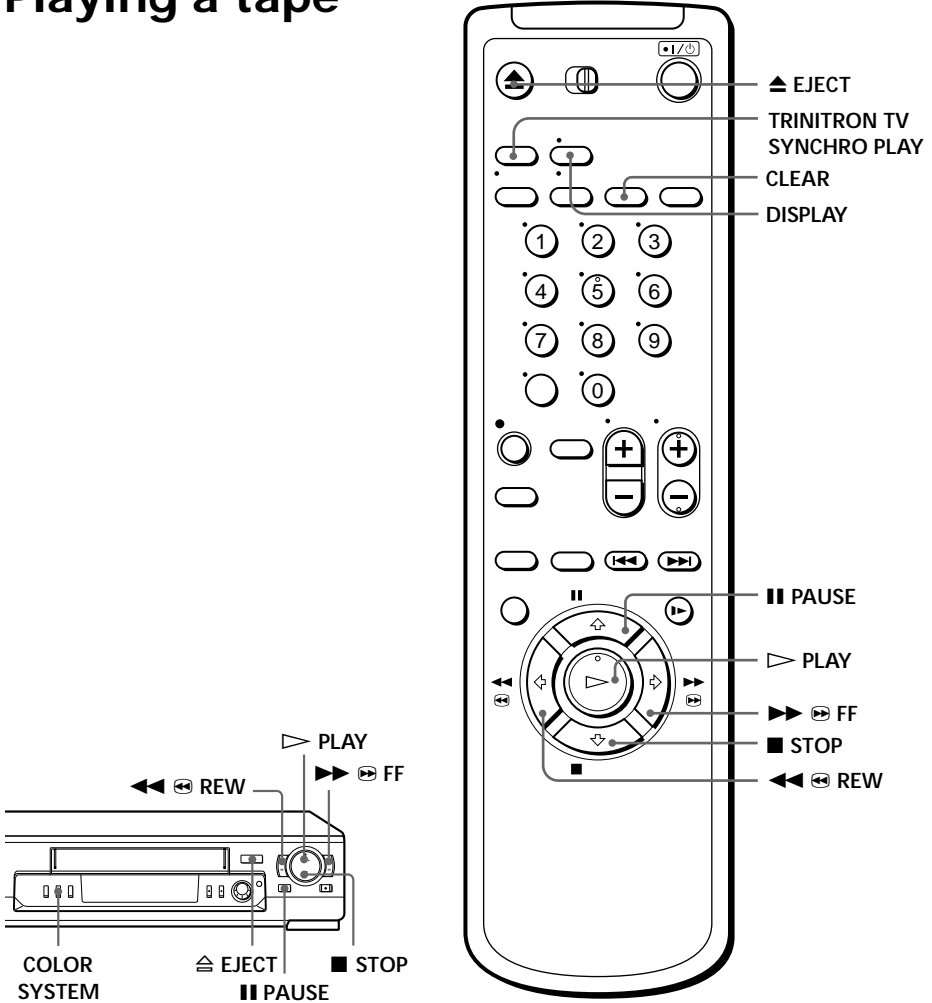

**1** Turn on your TV and set it to the video channel.



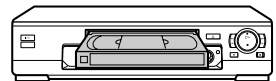

**2** Insert a tape.  
The VCR turns on and starts playing automatically if you insert a tape with its safety tab removed.



**3**Press  PLAY.

When the tape reaches the end, it will rewind automatically.

**Additional tasks**

To	Press
Stop play	■ STOP
Pause play	PAUSE
Resume play after pause	PAUSE or  PLAY
Fast-forward the tape	  FF during stop
Rewind the tape	  REW during stop
Eject the tape	▲ EJECT

**To set the colour system**

If streaks appear during playback, press COLOR SYSTEM on the VCR to conform to the system that the tape was recorded in. (Normally, the colour system is correctly set whenever the tape is inserted.)

If your tape was recorded in	Press COLOR SYSTEM until the indication below appears in the display window
PAL	PAL
NTSC	NTSC

**To play an NTSC-recorded tape**

Set NTSC PB in the SET UP MENU according to the colour system of your TV. For details, see page 56.

If your TV is	Set NTSC PB to
PAL	PAL
NTSC 4.43	4.43

## Playing a tape (continued)

### To use the time counter

At the point on the tape that you want to find later, press CLEAR. The counter in the display window resets to "0:00:00." Search for the point afterwards by referring to the counter.



To display the counter on the TV screen, press DISPLAY.

### Notes

- The counter resets to "0:00:00" whenever a tape is reinserted.
- The counter stops counting when it comes to a portion with no recording.
- While setting the menu on the TV screen, you cannot use the ▷ PLAY, || PAUSE, ►► FF, ◀◀ REW or ■ STOP button. These buttons are used for menu operations.
- If a tape has portions recorded in both PAL and NTSC systems, the time counter reading will not be correct. This is due to the difference between the counting cycles of the two colour systems.
- Depending on your TV, the following may occur while playing an NTSC-recorded tape:
  - the picture is black and white
  - the picture shakes
  - no picture appears on the TV screen
  - black streaks appear horizontally on the TV screen
  - the colour density increases or decreases.
- Tapes recorded in the LP mode of NTSC system on other VCRs can be played back on this VCR, but the picture quality cannot be guaranteed.



## Turning on the VCR and TV, and starting playback automatically (Trinitron TV Synchro Play)

You can only use this function if your TV is made by Sony (Trinitron TV).

### How to connect to use this function

Connect the VCR and TV with the audio/video cable (see “To a TV that has audio/video input jacks” on page 9). Be sure to connect the audio/video cable to the VIDEO IN 1 jacks on the TV if the TV has two inputs or more. The TV must be placed where it will respond to the remote commander while you are pointing it at the VCR.

### Operation

Make sure that the TV's main power is on.

Press TRINITRON TV SYNCHRO PLAY and hold the remote commander in place for about two seconds.

The VCR and TV turn on, and the TV is set to VCR reception. If there is a tape in the VCR, playback starts automatically.

### Notes

- If the Trinitron TV Synchro Play function does not work properly:
  - Wait a few moments, and press the button again.
  - Replace both of the batteries with new ones, and press the button again.Note that this function may not operate some Sony TVs because of the remote commander's signal limitations.
- Do not press TRINITRON TV SYNCHRO PLAY while playing back a video tape. If you do so, the TV's input source will momentarily switch to the TV's tuner.

# Recording TV programmes

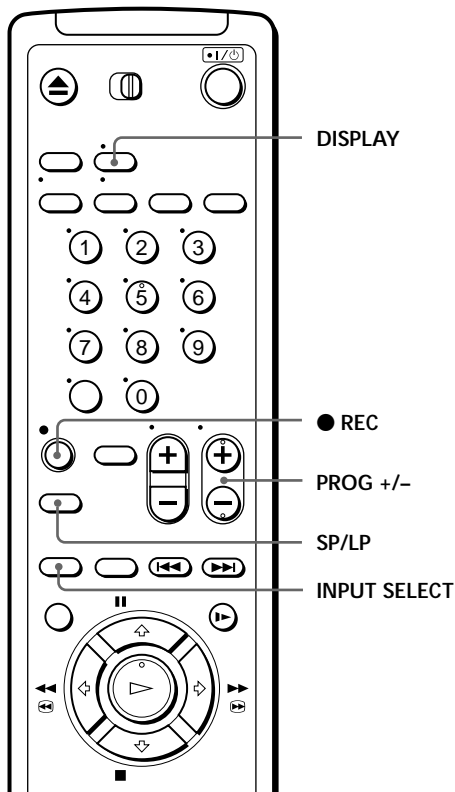

- 1** Turn on your TV and set it to the video channel.
- 2** Insert a tape with its safety tab in place.
- 3**  Press PROG +/- to select the programme position you want to record.

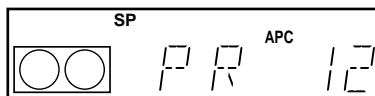

4



Press SP/LP to select the tape speed, SP or LP.

LP (Long Play) provides recording time twice as long as SP (Standard Play), however, SP produces better picture and audio quality.



5



Press ● REC to start recording.

The recording indicator lights up red in the display window.

Recording indicator



**To stop recording**

Press ■ STOP.

**To check the remaining tape length**

Press DISPLAY. The white bar indicates the approximate length of tape remaining.

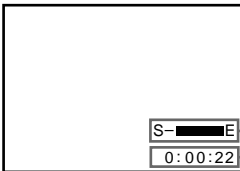

— Remaining tape length  
— Time counter

**To watch another TV programme while recording**

- 1 If the TV is connected to the VCR using an audio/video cable, set the TV to TV input. If the TV is connected to the VCR using only the aerial cable, skip this step.
- 2 Select another programme position on the TV.

continued

---

## Recording TV programmes (continued)

### To save a recording

To prevent accidental erasure, break off the safety tab as illustrated. To record on the tape again, cover the tab hole with adhesive tape.



### Tips

- To select a programme position, you can use the programme number buttons on the remote commander. For two-digit numbers, press the -- (ten's digit) button followed by the programme number buttons.
- You can select a video source from the LINE-1 IN jacks using INPUT SELECT or PROG +/- .
- The display appears on the TV screen indicating information about the tape, but the information will not be recorded on the tape.
- If you do not want to watch TV while recording, you can turn off the TV.

### Notes

- The display does not appear during still (pause) mode or slow-motion playback.
- It may take up to one minute for the VCR to calculate and display the remaining tape length after you press DISPLAY.
- The remaining tape length does not appear while playing in NTSC system.

# Recording TV programmes using the Easy Timer function

The Easy Timer function allows you to make a timer recording of a programme without turning on your TV. Set the recording timer to record only one programme that will be broadcast within the next 24 hours using the Easy Timer knob. If the VCR clock has not been set, you can also set the clock before setting the timer recording.

## Setting the Easy Timer

Before you start...

- Insert a tape with its safety tab in place. Make sure the tape is longer than the recording time.

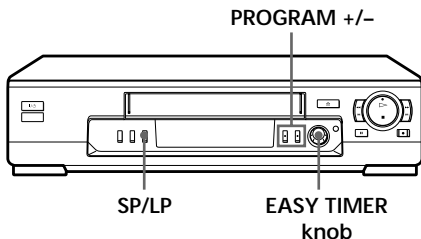

- 1** **EASY TIMER** Press the EASY TIMER knob.  
The START indicator appears in the display window.  
If the clock has not been set, “--:--” appears. Go to step 2 in “Setting or changing the Easy Clock” on page 39.



- 2** **EASY TIMER** Set the recording start time by turning the EASY TIMER knob clockwise or counterclockwise to increase or decrease the time by 15 minutes.

To increase or decrease the time by one minute, press PROGRAM +/-.

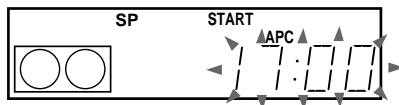

- 3** **EASY TIMER** Press the EASY TIMER knob to confirm the start time setting.  
The STOP indicator appears.

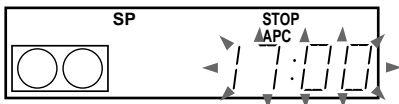

continued

## Recording TV programmes using the Easy Timer function (continued)



**4**  Set the recording stop time in the same way as in step 2, then press the EASY TIMER knob.

A programme number flashes.

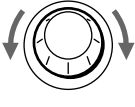

**5**  Turn the EASY TIMER knob clockwise or counterclockwise to select the programme you want to record.

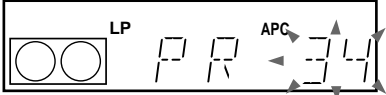
To select the tape speed, press SP/LP.



**6**  Press the EASY TIMER knob to confirm the setting.

The ⏻ indicator appears in the display window and the VCR stands by for recording.



## Setting or changing the Easy Clock

When “--:--” is displayed in the display window, the VCR clock has not been set. You need to set the clock using the Easy Clock function before setting the timer. You can also change the current time using the Easy Clock function.

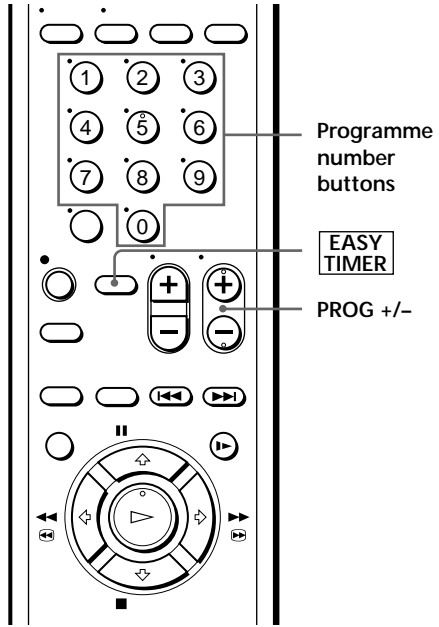
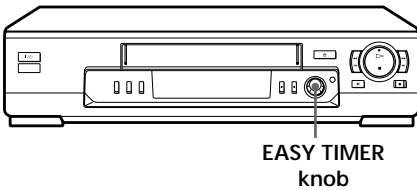

- When “--:--” is displayed in the display window, press the EASY TIMER knob.
  - To change the clock setting, press and hold the EASY TIMER knob on the VCR for more than three seconds.
- The CLOCK indicator and the current clock setting appear in the display window.

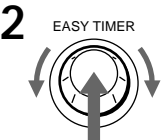
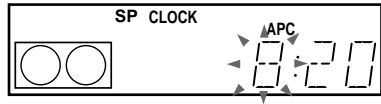

- Set the current time using the EASY TIMER knob.
- 1 Turn the EASY TIMER knob clockwise or counterclockwise to enter the current hour.
  - 2 Press the EASY TIMER knob to confirm the hour setting.
  - 3 Turn the EASY TIMER knob to increase or decrease the minutes setting by a minute.

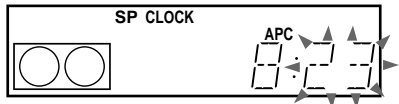

continued

## Recording TV programmes using the Easy Timer function (continued)

### 3



Press the EASY TIMER knob to confirm the clock setting.

The VCR enters the timer recording setting mode.

To continue the Easy Timer setting, go to step 2 in "Setting the Easy Timer" on page 37.

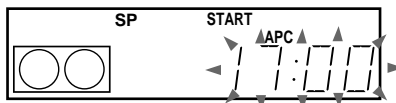

To quit the Easy Timer setting mode without changing any settings, press the EASY TIMER knob repeatedly until the ⏻ indicator appears in the display window.

### To set the timer and clock setting using the remote commander

You can also use the remote commander to set the Easy Timer and Easy Clock. The operations on the VCR and the remote commander correspond as follows:

To	Do this on the VCR	Do this on the remote commander
Confirm the setting and go to the next setting	Press EASY TIMER knob	Press <b>EASY TIMER</b>
Change the time by 15 minutes (in START/STOP mode)	Turn EASY TIMER knob or hold PROGRAM +/- down	Hold PROG +/- down
Change the time by one minute (in START/STOP mode)	Press PROGRAM +/-	Press PROG +/-
Select the programme	Turn EASY TIMER knob or press PROGRAM +/-	Press PROG +/- or INPUT SELECT
Change the hour/minute by one hour/minute (in CLOCK mode)	Turn EASY TIMER knob or press PROGRAM +/-	Press PROG +/-

You can also use the programme number buttons to set the clock, start and stop times, and the programme you want to record. Just press the programme number buttons to enter the hours and minutes. For example:

- To set the clock to "8:20", press 0, 8, **EASY TIMER**, 2, 0 and **EASY TIMER** in sequence.
- To set the start or stop time to "8:20", press 0, 8, 2, 0 and **EASY TIMER** in sequence.

If you make a mistake, re-enter the correct digits before pressing **EASY TIMER**.



### To stop recording

To stop the VCR while recording, press ■ STOP.

### To check or change the timer setting

Press the EASY TIMER knob repeatedly until the setting you want to check or change flashes. Then re-enter the new setting, if necessary. If you do not want to change any of the settings, press the EASY TIMER knob repeatedly until the ☺ indicator appears in the display window.

You can also change the timer setting using the TIMER SET/CHECK menu. For details, see page 50.

### To cancel the timer setting

To cancel the Easy Timer setting while doing the setting, press CLEAR on the remote commander or press PROGRAM + and – on the VCR at the same time.

### To use the VCR after setting the timer

To use the VCR before a timer recording begins, just press I/⏻. The ☺ indicator turns off and the VCR switches on. Remember to press I/⏻ to reset the VCR after using the VCR.

You can also do the following tasks while the VCR is recording:

- Reset the counter.
- Display tape information on the TV screen.
- Check the timer settings.
- Watch another TV programme.

### To watch the recorded programme right after the Easy Timer recording

The SEARCH indicator starts flashing when the VCR finishes the Easy Timer recording. To watch the recorded programme, press the EASY TIMER knob. The VCR turns on, starts searching, then automatically starts playback from the beginning of the recording. For details, see page 52.

continued

---

## **Recording TV programmes using the Easy Timer function (continued)**

### **Tip**

- To record from a source connected to LINE-1 IN jacks, press INPUT SELECT or PROG +/- or turn the EASY TIMER knob to display "L" in the display window.

### **Notes**

- You cannot set the Easy Timer if eight programmes have already been set.
- You can set the timer for only one programme using the Easy Timer function. If you want to set the timer for other programmes, use the G-CODE system (SLV-EZ44AZ/EZ22AZ only) or the TIMER SET/CHECK menu. For details, see pages 43 and 46.
- You cannot set the date using the Easy Timer function. Set the date using the CLOCK SET menu if you want to set the timer with the menu. For details, see page 12.
- The (⌚) indicator flashes in the display window when you complete the setting with no tape inserted.

# Recording TV programmes using the G-CODE system (SLV-EZ44AZ/EZ22AZ only)

Just enter the G-CODE number, listed in the TV programme guide, for the programme you want to record. The date, times and programme position of that programme are set automatically. You can preset up to eight programmes at a time.

### Before you start...

- Check that the VCR clock is set to the correct time.
- Insert a tape with its safety tab in place. Make sure the tape is longer than the total recording time.
- Turn on your TV and set it to the video channel.

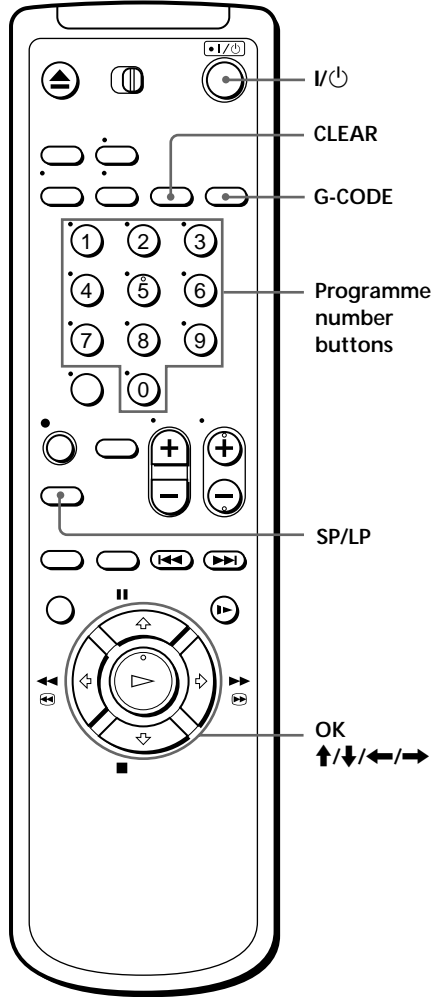

1



Press G-CODE.

G-CODE NO. [-----]	SP / LP [SP]
SET : [0 - 9]	
SP / LP : [SP / LP]	

continued

## Recording TV programmes using the G-CODE system (continued)

2

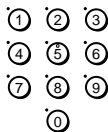

Press the programme number buttons to enter the G-CODE number for the programme you want to record.

If you make a mistake, press CLEAR and re-enter the correct number.

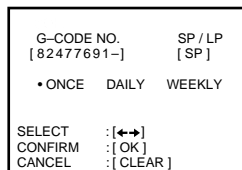

3



Press SP/LP to select the tape speed.

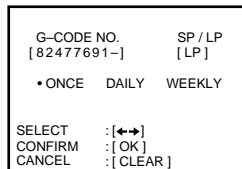

4



Select ONCE, DAILY or WEEKLY by using ←/→, then press OK:

To record	Select
Only once	ONCE
Everyday Monday to Friday	DAILY
Once a week	WEEKLY

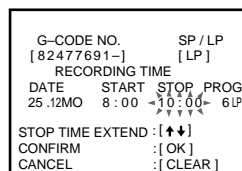

The date, start and stop times, programme position, and tape speed appear on the TV screen.

Press ↑/↓ to extend the stop time. Each press increases or decreases the stop time by five minutes up to one hour.

Press OK to confirm the stop time.

If the information is not correct, press CLEAR to cancel the setting.

5

To enter another setting, repeat steps 1 to 4.

6



Press I/⏻ to turn off the VCR.

The ⏻ indicator appears in the display window and the VCR stands by for recording.

### To stop recording

To stop the VCR while recording, press ■ STOP.

### To record satellite broadcasts

When you connect the satellite tuner and the VCR, you can record satellite programmes using the G-CODE number if applicable.

- 1** Turn on the satellite tuner.
- 2** On the satellite tuner, select the satellite programme for which you wish to make a timer setting.
- 3** Repeat the steps described on page 43 and page 44.
- 4** Keep the satellite tuner turned on until the VCR finishes recording the satellite programme for which you have made a timer setting.

#### Tip

- To cancel the procedure, press G-CODE before pressing OK.

#### Note

- The Ⓢ indicator flashes in the display window when you press I/Ⓢ with no tape inserted.

# Setting the timer manually

You can preset up to eight programmes at a time.

## Before you start...

- Check that the VCR clock is set to the correct time.
- Insert a tape with its safety tab in place. Make sure the tape is longer than the total recording time.
- Turn on your TV and set it to the video channel.

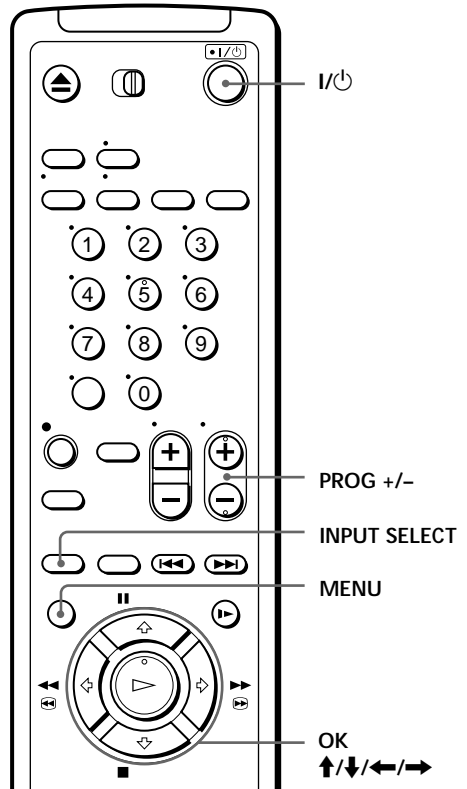

- 1** MENU Press MENU and select TIMER SET / CHECK, then press OK.



TIMER SET / CHECK	25 . 12 MO
DATE	START STOP PROG
▶---	---
---	---
---	---
---	---
---	---
---	---
---	---
---	---
---	---
---	---

- 2** Set the date, start and stop times, programme position, and tape speed:



- 1 Press **→** to flash each item in turn.
  - 2 Press **↑/↓** to set each item.
- To correct a setting, press **←** to return to that setting and reset.

TIMER SET / CHECK	25 . 12 MO
DATE	START STOP PROG
▶25 . 12 MO	---
---	---
---	---
---	---
---	---
---	---
---	---
---	---
---	---
---	---

To record the same programme every day or the same day every week, press **↓** while the date is flashing. For details, see "Daily / weekly recording" on page 47.

To record from a source connected to the LINE-1 IN jacks, press INPUT SELECT or PROG +/- to display "L" in the "PROG" position.

3



Press **→** to confirm the setting.

The cursor (▶) appears at the beginning of the line. To enter another setting, move the cursor to the next line and repeat step 2.

4



Press OK.

5



Press **I/⏻** to turn off the VCR.

The **⏻** indicator appears in the display window and the VCR stands by for recording.

To record from other equipment, leave the connected equipment switched on.

### To stop recording

To stop the VCR while recording, press **■ STOP**.

### Daily/weekly recording

In step 2 above, press **↓** to select the recording pattern. Each time you press **↓**, the indication changes as shown below. Press **↑** to change the indication in reverse order.

the current date → SU-SA (Sunday to Saturday) → MO-SA (Monday to Saturday) → MO-FR (Monday to Friday) → EVERY SA..... → EVERY MO → EVERY SU → 1 month later →(dates count down) → the current date

### Tips

- To set the programme position, you can also use the PROG +/- or programme number buttons.
- To set the tape speed, you can also use the SP/LP button.

### Note

- The **⏻** indicator flashes in the display window when you press **I/⏻** with no tape inserted.

# Playing/searching at various speeds

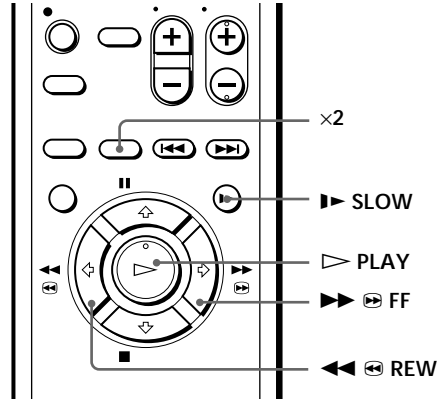
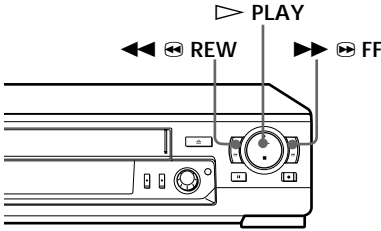

Playback options	Operation
View the picture during fast-forward or rewind	During fast-forward, hold ►►► FF down. During rewind, hold ◀◀◀ REW down.
Play at high speed	<ul style="list-style-type: none"> <li>• During playback, press ►►► FF or ◀◀◀ REW on the remote commander.</li> <li>• During playback, hold ►►► FF or ◀◀◀ REW down. When you release the button, normal playback resumes.</li> </ul>
Play at twice the normal speed	During playback or pause, press x2.
Play in slow motion	During playback or pause, press ►► SLOW.
Play frame by frame	During pause, press ►►► FF or ◀◀◀ REW on the remote commander. Hold the button down to play one frame each second.
Rewind and start play	During stop, press ▷ PLAY on the VCR while holding ◀◀◀ REW down on the VCR.

## To resume normal playback

Press ▷ PLAY.

### Tips

- Adjust the picture using TRACKING +/- on the VCR if:
  - streaks appear while playing in slow motion.
  - the picture shakes while pausing.
 To set tracking to the centre position, press both buttons (+/-) at the same time.
- If noise appears during pause or frame-by-frame playback, first switch to the slow motion playback, then adjust the picture using TRACKING +/- on the VCR.

### Notes

- The playback sound is muted during these operations.
- In LP or EP mode, noise may appear or there may be no colour.
- The picture may have snow when playing at high speed in reverse.
- On-screen symbols may shake while playing or searching at various speeds.



# Setting the recording duration time

After starting recording in the normal way, you can have the VCR stop recording automatically after a specified duration.

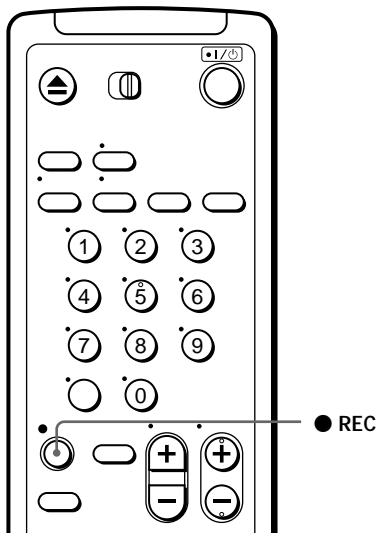

- 1 While recording, press ● REC.

The ⏸ indicator appears in the display window.

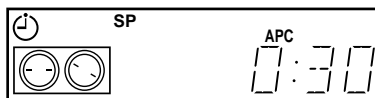

- 2 Press ● REC repeatedly to set the duration.

Each press advances the time in increments of 30 minutes.

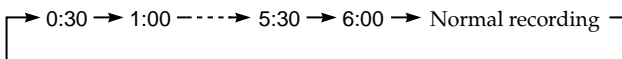

The tape counter decreases minute by minute to 0:00, then the VCR stops recording and turns off automatically.

## To extend the duration

Press ● REC repeatedly to set to the new duration.

## To cancel the duration

Press ● REC repeatedly until the ⏸ indicator turns off and the VCR returns to normal recording mode.

## To stop recording

To stop the VCR while recording, press ■ STOP.

# Checking/ changing/ cancelling timer settings

Before you start...

- Turn on your TV and set it to the video channel.

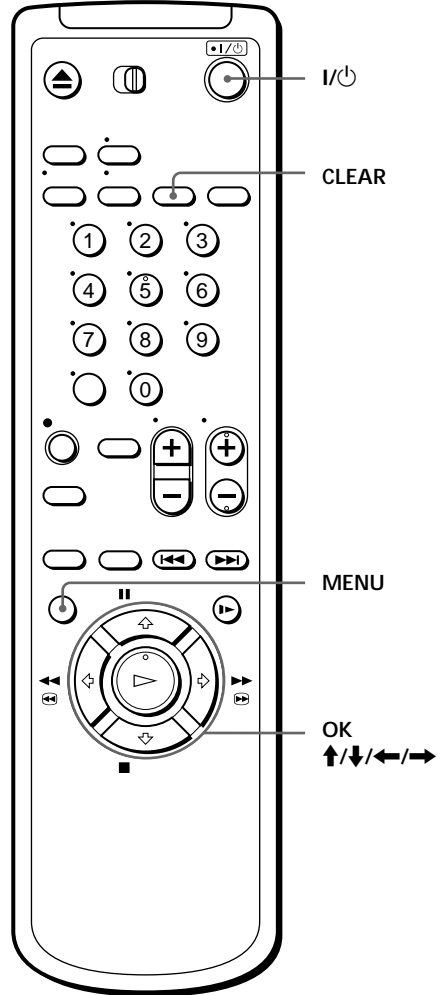

- 1 Press I/⏻ to turn on the VCR.
- 2 Press MENU, then select TIMER SET/CHECK:
  - If you want to change or cancel a setting, go on to the next step.
  - If you do not need to change or cancel the settings, press OK, then turn off the VCR to return to recording standby.

TIMER SET / CHECK	25.12	MO
DATE	START	STOP PROG
▶ 6.1 SA	7:00	8:00 6 SP
8.1 MO	9:00	11:00 50 LP
MO-SA	0:12	3:00 27 LP
EVERY SU	11:00	12:00 L SP
---	---	---
---	---	---
---	---	---
---	---	---

- 
- 3** Press **↑/↓** to select the setting you want to change or cancel:
- To change the setting, press **←/→** to flash the item you want to change, and press **↑/↓** to reset it. Then, press **→** repeatedly until the cursor (**▶**) appears at the beginning of the line.
  - To cancel the setting, press **CLEAR**.
- 4** Press **OK**.
- If any timer settings remain, turn off the VCR to return to recording standby.

### When the timer settings overlap

The programme that starts first has priority and the second programme starts recording only after the first programme has finished. If the programmes start at the same time, the programme listed first in the menu has priority.

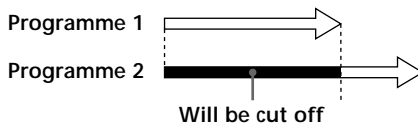

continued

---

# Searching the beginning of an Easy Timer recorded programme

If you record a programme using the Easy Timer function, you can easily find the beginning of the recording with this SEARCH function. The SEARCH indicator flashes when the VCR finishes the Easy Timer recording.

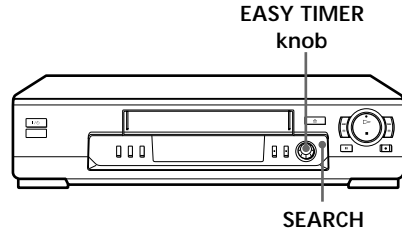

Press the EASY TIMER knob.

The VCR turns on, rewinds to the beginning of the recorded programme and starts playback automatically.

## Tip

- To stop the flashing of the SEARCH indicator, first turn the VCR on, then press the SEARCH button. (Do not press any button at this point, otherwise this SEARCH mode will be cancelled.) To start the SEARCH function, press the SEARCH button once. If you press the SEARCH button repeatedly, you can enter the index search mode (for details, see page 54).

## Notes

- This SEARCH function will be cancelled (the SEARCH indicator turns off) if:
  - The VCR starts recording other programmes.
  - You press ▷ PLAY, ►► ⏩ FF, ◀◀ ⏪ REW or ⏏ EJECT button while the VCR is on.
- With this SEARCH function, you can find the beginning of a programme recorded using the Easy Timer function only.

# Searching using the index function

The VCR marks the tape with an index signal at the point where each recording begins. Use these signals as references to find a specific recording. The VCR can search up to 99 index signals ahead of or behind the current position. You can either use the INDEX SEARCH buttons on the remote commander or the SEARCH button and EASY TIMER knob on the VCR.

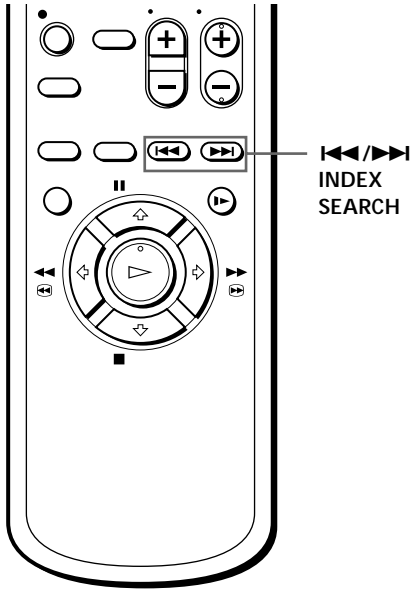

## Using the INDEX SEARCH buttons on the remote commander

- 1 Insert an indexed tape into the VCR.
- 2 Press **◀◀/▶▶** INDEX SEARCH repeatedly to specify how many index signals ahead or behind you want to search:
  - To search ahead, press **▶▶** INDEX SEARCH.
  - To search backwards, press **◀◀** INDEX SEARCH.

The VCR starts searching and the index number on the TV screen counts down to zero. The playback starts from the point about five seconds ahead of the specified index mark.

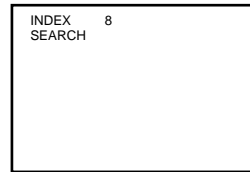

**continued**

## Searching using the index function (continued)

### Using the SEARCH button and EASY TIMER knob on the VCR

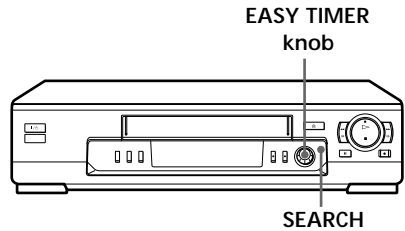

- 1 Press SEARCH on the VCR repeatedly until "INDEX" appears in the display window (the SEARCH indicator lights up).

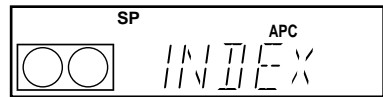

- 2 Turn the EASY TIMER knob to specify how many index signals ahead or behind you want to search:
  - To search ahead, turn the EASY TIMER knob clockwise.
  - To search backwards, turn the EASY TIMER knob counterclockwise.

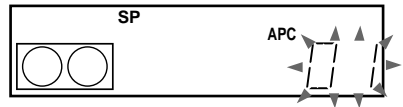

- 3 Press the EASY TIMER knob.

The VCR starts searching. The playback starts (the SEARCH indicator turns off) from the point about five seconds ahead of the specified index mark.

#### To stop searching

Press ■ STOP.

#### Note

- No index signal will be added when recording starts from recording pause. However, an index signal will be marked if you change the channel during recording pause.

# Adjusting the picture

## Adjusting the tracking

Although the VCR automatically adjusts the tracking when playing a tape (the  indicator flashes in the display window, then goes off), distortion may occur if the tape was recorded in poor condition. If so, manually adjust the tracking.

Press TRACKING +/- buttons on the VCR to display the tracking meter. The distortion should disappear as you press one of the two buttons. (The  indicator lights up.) To resume automatic tracking adjustment, eject the tape and reinsert it.

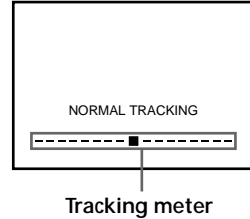

## About the Adaptive Picture Control (APC) function

The Adaptive Picture Control (APC) function automatically improves recording and playback quality by adjusting the VCR to the condition of the video heads and tape. To maintain better picture quality, we recommend that you set APC to ON in the SET UP MENU (with the APC indicator in the display window lit).

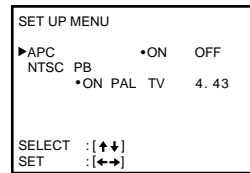

### APC playback

The APC function automatically works on all types of tapes, including rental tapes and tapes that were not recorded with APC.

### APC recording

Whenever you insert a tape and first start recording, the VCR adjusts to the tape using the APC function (the APC indicator flashes rapidly). This adjustment is retained until the tape is ejected.

### To deactivate the APC function

Press MENU and select SET UP MENU, then set APC to OFF. The APC indicator in the display window goes off.

#### Tip

- To set the tracking to the centre position, press the TRACKING + and - buttons at the same time.

#### Note

- There is a delay of a few seconds before the VCR actually starts recording while the VCR analyses the tape. To avoid the delay, first set the VCR to recording pause (the APC indicator flashes slowly) and press ● REC to have the VCR analyse the tape (the APC indicator flashes rapidly). After the APC indicator stops flashing, press ■ PAUSE to start recording immediately. If you press ■ PAUSE before the APC indicator stops flashing, the APC function is cancelled.

continued

# Changing menu options

- 1 Press MENU, then select SET UP MENU.

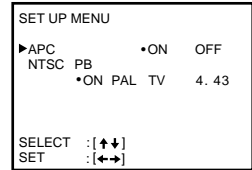

- 2 Press **↑/↓** to select the option to change, then press **←/→** to change the setting.
- 3 Press OK to return to the original screen.

## Menu choices

Initial settings are indicated in bold print.

Menu option	Set this option to
APC	<b>ON</b> to switch on the APC (Adaptive Picture Control) function and improve picture quality. OFF to switch off APC.
NTSC PB	<b>ON PAL TV</b> to play back an NTSC-recorded tape on a PAL TV. 4.43 to play back an NTSC-recorded tape on an NTSC TV. For details, see page 31.



# Editing with another VCR

## How to connect to record on this VCR

e.g. SLV-EZ44AZ

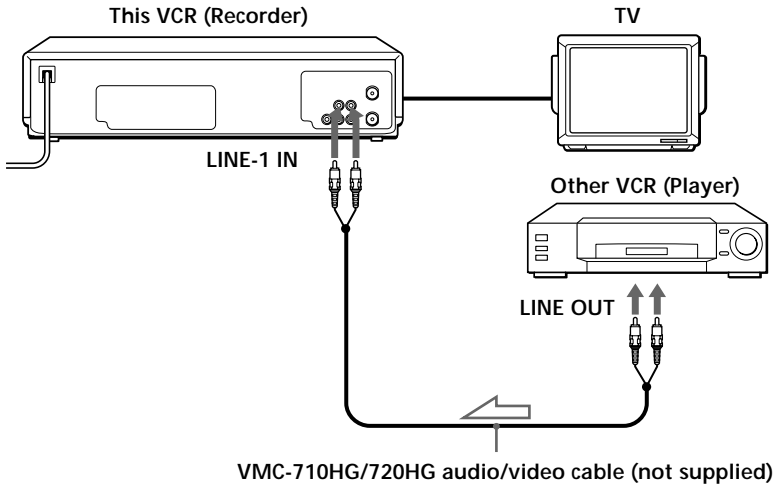

 : Signal flow

### Tip

- Connect LINE-1 IN on this VCR to the line output jacks on the other VCR using a commercially available audio/video cable such as Sony VMC-710HG/720HG (not supplied). If the other VCR has the AUDIO L and R jacks, use a Sony VMC-910HG audio/video cable (not supplied).

### Notes

- If you connect this VCR to both the LINE IN and LINE OUT jacks of the other VCR, select the input correctly to prevent a humming noise.
- Make sure you connect the plugs to the jacks of the same colour.

continued

## Editing with another VCR (continued)

### Operation (when recording on this VCR)

#### Before you start editing

- Turn on your TV and set it to the video channel.
- Press INPUT SELECT or PROG +/- to display "L" in the display window.
- Press SP/LP to select the tape speed.

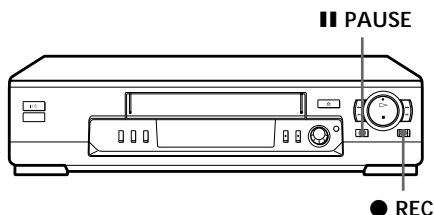

- 1 Insert a source tape with its safety tab removed into the other (playback) VCR. Search for the point to start playback and set it to playback pause.
- 2 Insert a tape with its safety tab in place into this (recording) VCR. Search for the point to start recording and press **|| PAUSE**.
- 3 Press **● REC** on this VCR and set it to recording pause.
- 4 To start editing, press the **|| PAUSE** buttons on both VCRs at the same time.

#### To stop editing

Press the **■ STOP** buttons on both VCRs.

#### Tips

- To edit more precisely, press the **|| PAUSE** buttons on the VCRs to release pause.
- To cut out unwanted scenes while editing, press **|| PAUSE** on this VCR when an unwanted scene begins. When it ends, press **|| PAUSE** again to resume recording.

#### Note

- If you start recording following the procedure above, the VCR will not start recording with the APC function. To record a tape with the APC function, press **● REC** again during recording pause in step 3 so that the VCR analyses the tape. Then when you start recording in step 4, press **|| PAUSE** after the APC indicator stops flashing. If you press **|| PAUSE** before the APC indicator stops flashing, the APC function is cancelled.

# Troubleshooting

If you have any questions or problems not covered below, please consult your nearest Sony service facility.

	Symptom	Remedy
Power	The I/⏻ ON/STANDBY switch does not function.	<ul style="list-style-type: none"> <li>Connect the mains lead to the mains securely.</li> </ul>
	The power is turned on but the VCR does not operate.	<ul style="list-style-type: none"> <li>Moisture condensation has occurred. Turn the power off, unplug the mains lead and leave the VCR to dry for over four hours.</li> </ul>
Clock	The clock has stopped and “-:-” lights in the display window.	<ul style="list-style-type: none"> <li>The clock stops if the VCR is disconnected from the mains for more than eight hours. Reset the clock (and timer).</li> </ul>
	The playback picture does not appear on the TV screen.	<ul style="list-style-type: none"> <li>Make sure the TV is set to the video channel. If you are using a monitor, set it to video input.</li> <li>If you made connections using the aerial cable only, make sure the RF channel number is set correctly for your area.</li> </ul>
Playback	The picture or sound is distorted.	<ul style="list-style-type: none"> <li>Adjust the tracking with the TRACKING +/- buttons.</li> <li>Make sure the colour system is correctly set to the system that the tape was recorded in.</li> </ul>
	The picture is not clear, or a message appears indicating that the video heads need cleaning.	<ul style="list-style-type: none"> <li>The video heads are dirty (see page 61). Clean the video heads using the Sony T-25CLD, T-25CLW or E-25CLDR video head cleaning cassette. If these cleaning cassettes are not available in your area, have the heads cleaned at your nearest Sony service facility (a standard service charge will be required). Do not use a commercially available liquid type cleaning cassette other than Sony's, as they may damage the video heads.</li> <li>If a message appears, this indicates that the Head Condition Sensor has detected dirty video heads. Follow the on-screen message. For details about the Head Condition Sensor, see page 61.</li> <li>The video heads may have to be replaced. Consult your local Sony service facility for more information.</li> </ul>
	The picture rolls vertically during picture search.	<ul style="list-style-type: none"> <li>Adjust the vertical hold control on the TV or monitor.</li> </ul>
	The picture has no sound.	<ul style="list-style-type: none"> <li>The tape is defective.</li> <li>If you made A/V connections, check the audio cable connection.</li> </ul>

**continued**

## Troubleshooting (continued)

	Symptom	Remedy
Recording	No TV programmes appear on the TV screen.	<ul style="list-style-type: none"> <li>• Make sure the TV is set to the video channel. If you are using a monitor, set it to video input.</li> <li>• Select the correct source with the INPUT SELECT or PROG +/- buttons. Select a programme position when recording TV programmes; select "L" when recording from other equipment.</li> </ul>
	TV reception is poor.	<ul style="list-style-type: none"> <li>• Adjust the TV aerial.</li> <li>• Make sure COUNTRY in the TUNER PRESET menu is set to the country you live in.</li> </ul>
	The tape starts playing as soon as it is inserted.	<ul style="list-style-type: none"> <li>• The safety tab has been removed. To record on this tape, cover the tab hole.</li> </ul>
	The tape is ejected when you press ● REC.	<ul style="list-style-type: none"> <li>• Check that the safety tab has not been removed.</li> </ul>
	Nothing happens when you press ● REC.	<ul style="list-style-type: none"> <li>• Make sure the tape is not at its end.</li> </ul>
Timer recording	The timer does not operate.	<ul style="list-style-type: none"> <li>• Check that the clock is set.</li> <li>• Make sure a tape has been inserted.</li> <li>• Check that the safety tab has not been removed.</li> <li>• Make sure the tape is not at its end.</li> <li>• Make sure a programme has been set for timer recording.</li> <li>• Make sure your timer settings are past the current time.</li> <li>• Check that the satellite tuner is turned on.</li> <li>• The clock stops if the VCR is disconnected from the mains for more than eight hours. Reset the clock and timer.</li> </ul>
Others	A tape cannot be inserted.	<ul style="list-style-type: none"> <li>• Check that a tape is not already in the tape compartment.</li> </ul>
	The remote commander does not function.	<ul style="list-style-type: none"> <li>• Make sure you are pointing the remote commander at the remote sensor on the VCR.</li> <li>• Replace all the batteries in the remote commander with new ones if they are weak.</li> <li>• Make sure the <b>TV</b> / <b>VIDEO</b> remote control switch is set correctly.</li> </ul>
	You cannot control other TVs. (SLV-EZ44AZ / EZ22AZ only)	<ul style="list-style-type: none"> <li>• Set your TV's code number. The code number resets to 01 when you replace the batteries of the remote commander.</li> </ul>
	The tracking meter does not appear on the screen.	<ul style="list-style-type: none"> <li>• The recording condition of the tape is very poor and tracking cannot be adjusted.</li> </ul>
	The VCR needs to be cleaned.	<ul style="list-style-type: none"> <li>• Clean the cabinet, panel and controls with a dry, soft cloth, or a soft cloth slightly moistened with a mild detergent solution. Do not use any type of solvent, such as alcohol or benzine.</li> </ul>

## Symptoms caused by contaminated video heads

- Normal picture
- Rough picture
- Unclear picture
- No picture (or black & white screen appears)

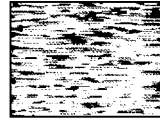
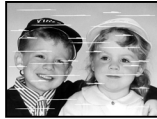

initial  
contamination



terminal

## Sapphire tape cleaner (SLV-EZ44AZ/EZ22AZ only)

The unit incorporates a sapphire tape cleaner which cleans a video tape when it is loaded. This cleaner can prevent the video heads from contamination by removing dust or mold from a tape with the sapphire edge.

## Head Condition Sensor

The Head Condition Sensor checks the video heads condition. If the heads are dirty, a message will instruct you to insert a video head cleaning cassette.

(For SLV-EZ44AZ only)

The VCR may temporarily switch to a different head and resume playback. To switch the heads, press  $\triangleright$  PLAY while the "PUSH [PLAY] TO RESUME TEMPORARILY" message appears on the screen. Although playback will resume, the sound will be monaural. When playback is finished, be sure to clean the heads with a video head cleaning cassette.

Be sure to use the Sony T-25CLD, T-25CLW or E-25CLDR video head cleaning cassette. If these cleaning cassettes are not available in your area, have the heads cleaned at your nearest Sony service facility (a standard service charge will be required).

# Specifications

## System

### Channel coverage

COUNTRY is set to AUS:  
VHF AS0 to AS12, AS5A, AS9A  
UHF AS28 to AS69  
CATV S01 to S05, S1 to S41  
COUNTRY is set to NZ:  
VHF NZ1 to NZ11  
UHF E21 to E69  
CATV S01 to S05, S1 to S41

### RF output signal

UHF channels: 28 to 69

### Aerial out

75-ohm asymmetrical aerial socket

## Inputs and outputs

### LINE-1 IN

VIDEO IN, phono jack (1 each)  
Input signal: 1 Vp-p, 75 ohms, unbalanced,  
sync negative  
AUDIO IN, phono jack (1 each)  
Input level: 327 mVrms  
Input impedance: more than 47 kilohms

### LINE-1 OUT (SLV-EZ44AZ)

VIDEO OUT, phono jack (1)  
Output signal: 1 Vp-p, 75 ohms, unbalanced,  
sync negative  
AUDIO OUT, phono jack (2)  
Standard output: 327 mVrms  
Load impedance: 47 kilohms  
Output impedance: less than 10 kilohms

### LINE-1 OUT (SLV-EZ22AZ/EZ11AZ)

VIDEO OUT, phono jack (1)  
Output signal: 1 Vp-p, 75 ohms, unbalanced,  
sync negative  
AUDIO OUT, phono jack (1)  
Standard output: 327 mVrms  
Load impedance: 47 kilohms  
Output impedance: less than 10 kilohms

## General

### Power requirements

220 – 240 V AC, 50 Hz

### Power consumption

15 W

### Operating temperature

5°C to 40°C

### Storage temperature

-20°C to 60°C

### Dimensions

Approx. 430 × 97 × 288 mm (w/h/d)  
including projecting parts and controls

### Mass

Approx. 4.1 kg

### Power back-up

Built-in self-charging capacitor

Back-up duration: up to 8 hours at a time

## Supplied accessories

Remote commander (1)

R6 (size AA) batteries (2)

Aerial cable (1)

Design and specifications are subject to change without notice.

ENERGY STAR® is a U.S. registered mark.

As an ENERGY STAR® Partner, Sony Corporation has determined that this product meets the ENERGY STAR® guidelines for energy efficiency.

# Index to parts and controls

Refer to the pages indicated in parentheses ( ) for details.

## Front panel

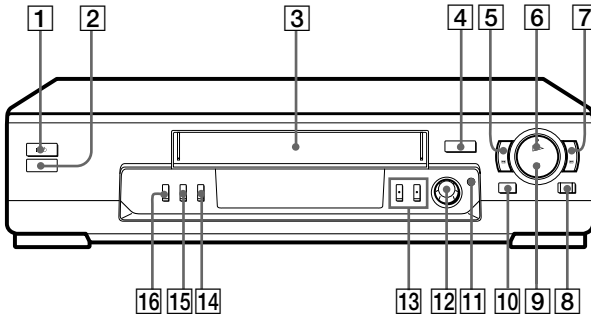

- |   |  |
|---|--|
| <b>1</b> I/⏻ ON/STANDBY switch (10)             | <b>10</b> ■■ PAUSE button (31)   |
| <b>2</b> Remote sensor (5)                      | <b>11</b> SEARCH button/indicator (52, 54)                               |
| <b>3</b> Tape compartment                       | <b>12</b> EASY TIMER knob (37, 52, 54)                                   |
| <b>4</b> ≡ EJECT button (31)                    | <b>13</b> PROGRAM/TRACKING +/- buttons (10, 55)                          |
| <b>5</b> ◀◀ ⏮ REW (rewind) button (31, 48)      | <b>14</b> SP (Standard Play)/LP (Long Play) button (35)                  |
| <b>6</b> ▷ PLAY button (31)                     | <b>15</b> COLOR SYSTEM button (31)                                       |
| <b>7</b> ▶▶ ⏭ FF (fast-forward) button (31, 48) | <b>16</b> ONE TOUCH TUNING/ RF (Radio Frequency) CHANNEL button (10, 16) |
| <b>8</b> ● REC (record) button (35)             |  |
| <b>9</b> ■ STOP button (31)                     |  |

continued

## Index to parts and controls (continued)

### Display window

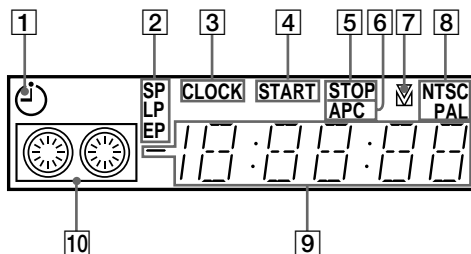

- |   |   |
|---|---|
| <b>1</b> Timer indicator (38, 47)                         | <b>7</b> Tracking indicator (55)  |
| <b>2</b> Tape speed indicator (35)                        | <b>8</b> Colour system indicator (31)                                     |
| <b>3</b> CLOCK indicator (39)                             | <b>9</b> Time counter/clock/line/<br>programme indicator (32, 34, 38, 58) |
| <b>4</b> START indicator (37)                             | <b>10</b> Tape/recording indicator (35)                                   |
| <b>5</b> STOP indicator (37)                              |   |
| <b>6</b> APC (Adaptive Picture Control)<br>indicator (55) |   |



## Rear panel (SLV-EZ44AZ)

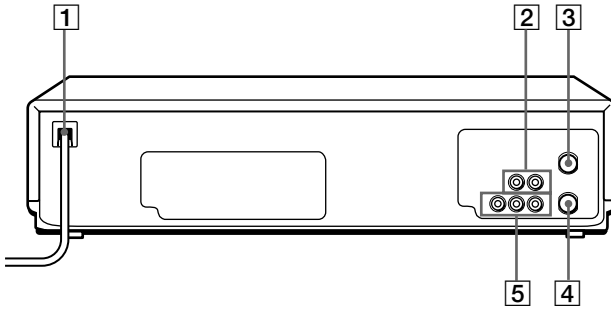

- 1** Mains lead (8)
- 2** LINE-1 IN AUDIO/VIDEO jacks (57)
- 3** AERIAL IN connector (8)
- 4** AERIAL OUT connector (8)
- 5** LINE-1 OUT AUDIO (MONO)/VIDEO jacks (9)

## Rear panel (SLV-EZ22AZ/EZ11AZ)

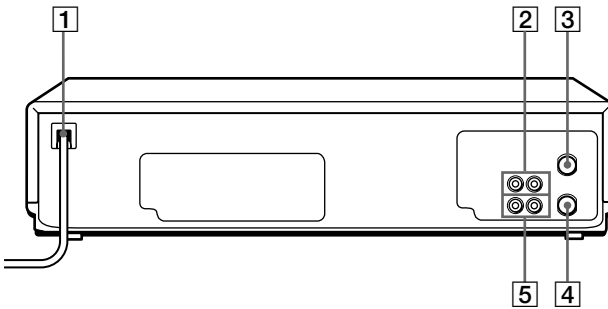

- 1** Mains lead (8)
- 2** LINE-1 IN AUDIO/VIDEO jacks (57)
- 3** AERIAL IN connector (8)
- 4** AERIAL OUT connector (8)
- 5** LINE-1 OUT AUDIO/VIDEO jacks (9)

continued

## Index to parts and controls (continued)

### Remote commander

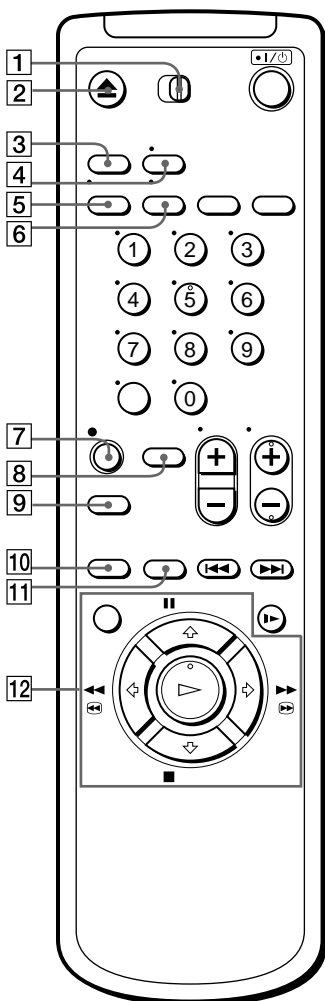

- 1 TV/VIDEO remote control switch (5)
- 2 ▲ EJECT button (31)
- 3 TRINITRON TV SYNCHRO PLAY button (33)
- 4 DISPLAY button (32, 35)
- 5 WIDE button (*for TV*) (7)  
(SLV-EZ44AZ/EZ22AZ)
- 6 TV/VIDEO button (*for TV*) (5)
- 7 ● REC (record) button (35, 49)
- 8 EASY TIMER button (40)
- 9 SP (Standard Play)/LP (Long Play) button (35)
- 10 INPUT SELECT button (36, 47)
- 11 ×2 button (48)
- 12 Tape/menu operation buttons
  - MENU button (12, 56)
  - ▬ PAUSE/▲ button (31)
  - STOP/▼ button (31)
  - ◀◀ ⏮ REW (rewind)/  
◀ button (31, 48)
  - ▶▶ ⏭ FF (fast-forward)/  
▶ button (31, 48)
  - ▷ PLAY/OK button (31)

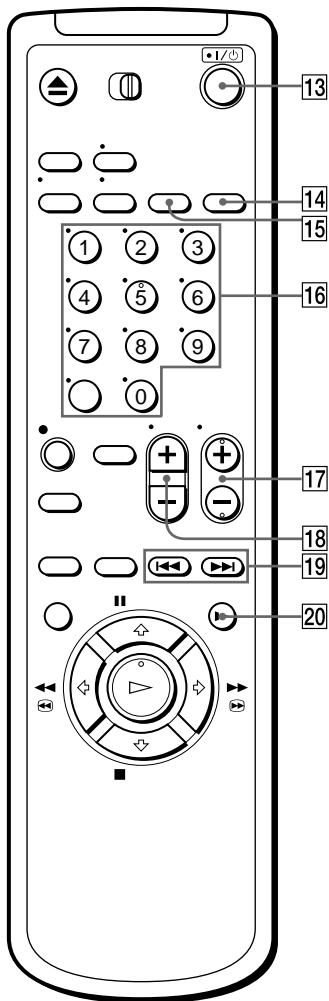

13 I/⏻ (on/standby) switch (44, 47)

14 G-CODE button (43)  
(SLV-EZ44AZ/EZ22AZ only)

15 CLEAR button (32, 44)

16 Programme number /-/-- (ten's  
digit) buttons (36, 40, 44)

17 PROG (programme) +/- buttons  
(34)

18 VOL (volume) +/- buttons (*for TV*)

19 ◀◀ / ▶▶ INDEX SEARCH  
buttons (53)

20 ▶▶ SLOW button (48)

---

# Index

## A, B

- Accessories supplied 4
- Adjusting
  - picture 22, 48, 55
  - tracking 48, 55
- Aerial hookup 8
- AFT (Auto Fine Tuning) 22
- APC (Adaptive Picture Control) 55
- AV (audio/video) connection 9

## C

- Cancelling timer settings 50
- Changing the programme position 26
- Changing timer settings 50
- Checking timer settings 50
- Cleaning the video heads 59
- Clock setting 12
- Colour system
  - compatible colour systems 2
  - setting 31
- Connecting
  - the VCR and your TV 8
  - to a TV with audio/video jacks 9
- Counter 32

## D

- Disabling programme position 22, 28
- Dubbing. *See* Editing

## E, F

- Easy Clock 39
- Easy Timer recording 37
- Editing 57

## G

- G-CODE
  - recording 43
  - setting 14, 23
- Guide channel
  - setting up automatically 14
  - setting up manually 23

## H

- Head Condition Sensor 61

## I, J, K

- Index
  - searching 53

## L, M

- LP mode 32, 35

## N

- NTSC-recorded tapes 31

## O

- One Touch Tuning 16

## P, Q

- Picture adjustment 22, 48, 55
- Playback 30
  - at various speeds 48
  - frame-by-frame 48
  - slow motion 48
- Presetting channels
  - automatically 18
  - manually 20
  - One Touch Tuning 16
  - using the EASY G-CODE SET UP function 14

## R

- Recording 34
  - duration time 49
  - saving 36
  - using the Easy Timer function 37
  - using the G-CODE system 43
  - while watching another programme 35
- Remote commander 5

## S

- Safety tab 36
- Searching
  - at various speeds 48
  - the beginning of an Easy Timer recorded programme 52
  - using the index function 53
- SP mode 35

## T, U, V, W, X, Y, Z

- Timer recording
  - cancelling timer settings 50
  - changing timer settings 50
  - checking timer settings 50
  - daily/weekly recording 47
  - Easy Timer 37
  - overlapping timer recordings 51
  - using the G-CODE system 43
- Tracking adjustment 48, 55
- Trinitron TV Synchro Play 33
- Tuning your TV to the VCR 10