

SONY®

3-043-516-13(1)

Portable MiniDisc Recorder

Operating Instructions



MZ-R70

©2000 Sony Corporation

WARNING

To prevent fire or shock hazard, do not expose the unit to rain or moisture.

To avoid electrical shock, do not open the cabinet. Refer servicing to qualified personnel only.

Do not install the appliance in a confined space, such as a bookcase or built-in cabinet.

Caution

The use of optical instruments with this product will increase eye hazard.

Listening for many hours at maximum volume may damage your hearing.

**CAUTION — INVISIBLE LASER RADIATION WHEN OPEN
AVOID EXPOSURE TO BEAM**

Information

IN NO EVENT SHALL SELLER BE LIABLE FOR ANY DIRECT, INCIDENTAL OR CONSEQUENTIAL DAMAGES OF ANY NATURE, OR LOSSES OR EXPENSES RESULTING FROM ANY DEFECTIVE PRODUCT OR THE USE OF ANY PRODUCT.

For customers in the USA

This equipment has been tested and found to comply with the limits for a Class B digital device, pursuant to Part 15 of the FCC Rules. These limits are designed to provide reasonable protection against harmful interference in a residential installation. This equipment generates, uses, and can radiate radio frequency energy and, if not installed and used in accordance with the instructions, may cause harmful interference to radio communications. However, there is no guarantee that interference will not occur in a particular installation. If this equipment does cause harmful interference to radio or television reception, which can be determined by turning the equipment off and on, the user is encouraged to try to correct the interference by one or more of the following measures:

- Reorient or relocate the receiving antenna.
- Increase the separation between the equipment and receiver.
- Connect the equipment into an outlet on a circuit different from that to which the receiver is connected.

- Consult the dealer or an experienced radio/TV technician for help.

You are cautioned that any changes or modifications not expressly approved in this manual could void your authority to operate this equipment.

Owner's Record

The serial number is located at the rear of the disc compartment lid and the model number is located at the top and bottom. Record the serial number in the space provided below. Refer to them whenever you call upon your Sony dealer regarding this product.

Model No. MZ-R70

Serial No. _____

RECYCLING NICKEL-CADMIUM BATTERIES

Nickel-Cadmium batteries are recyclable. You can help preserve our environment by returning your unwanted batteries to your nearest point for collection, recycling or proper disposal.

Note: In some areas the disposal of nickel-cadmium batteries in household or business trash may be prohibited.



RBRC (Rechargeable Battery Recycling Corporation) advises you about spent battery collection by the following phone number.

Call toll free number: 1-800-822-8837 (United States and Canada only)

Caution: Do not handle damaged or leaking nickel-cadmium batteries.

For Customers in Australia

If the supply cord of the AC power adaptor is damaged, the AC power adaptor must be returned to the manufacturer or his agent for the cord to be replaced.

“MD WALKMAN” is a trademark of Sony Corporation.

The CE mark on the unit is valid only for products marketed in the European Union.

This mark is valid for Russia only.



AR46

Welcome!

Welcome to the world of the MiniDisc! Here are some of the capabilities and features you'll discover with the new MiniDisc Recorder.

- Recording MD Walkman in an compact body — Easy to carry in your pocket or bag.
- Simple “Pop-Up Eject” function for easy MiniDisc handling — A single press of a button on the side of the recorder causes the recorder lid to open and the MiniDisc to eject.
- Shock-resistant memory — Offsets up to 40 seconds of optical read errors.
- Dual phone jacks for greater versatility — Two phone jacks are provided for connection of up to two headphones.
- Remote control with editing capabilities — You can now label tracks and discs, change track sequence, etc., with the easy-to-operate remote control.
- Simultaneous labeling feature — No more waiting for the recording to end; you can label tracks and discs while the MD is being recorded.
- Digital synchro-recording — When recording from a digital equipment with optical output, the recorder automatically starts and pauses recording in sync with operation on the digital source.
- Sampling rate converter — This unit enables you to record programs from digital equipment using other sampling rates, such as a BS tuner or DAT deck.
- The recorder comes in three fashionable colors.
- Digital rec level control.

Table of contents

Recording an MD right away!	8
Playing an MD right away!	12

Various ways of recording

Two ways of connecting to a sound source	16
Recording with analog input (line cable required)	18
To start/stop recording in sync with the source player (Synchro-recording)	19
Recording from a microphone	21
Recording in monaural for double the normal recording time	22
Adjusting the recording level manually (Manual recording)	23
Checking the remaining time or the recording position	25
On the recorder	25
On the remote control	28

Various ways of playback

Selecting a track directly	29
Playing tracks repeatedly	30
On the recorder	30
On the remote control	31
Emphasizing bass (DIGITAL MEGA BASS)	32
On the recorder	32
On the remote control	33
Protecting your hearing (AVLS)	34
On the recorder	34
On the remote control	34
Checking the remaining time or the playing position	35
On the recorder	35
On the remote control	36
Locking the controls (HOLD)	37
Connecting to a stereo system	38

Editing recorded tracks

Erasing tracks	40
To erase a track	40
To erase the whole disc	42

Adding a track mark	44
Erasing a track mark	45
Moving recorded tracks	46
On the recorder	46
On the remote control	47
Labeling recordings	48
On the recorder	48
On the remote control	50

Power sources

Charging the nickel cadmium rechargeable battery	53
Using on a battery	55

Additional information

Precautions	56
Troubleshooting	60
System limitations	63
Messages	65
Specifications	68
What is an MD?	70
Looking at the controls	72

Recording an MD right away!

Connect to a digital source using an optical cable (supplied) to make digital recordings. Digital recording is possible even from digital equipment with different sampling rates, such as a DAT deck or a BS tuner, using the built-in sampling rate converter. To record from an analog source, see “Recording with analog input (line cable required)” (page 18). To record from an MD, see “Note on digital recording” (page 59).

1

Make connections.

(Insert the cables firmly and completely into the appropriate jacks.)

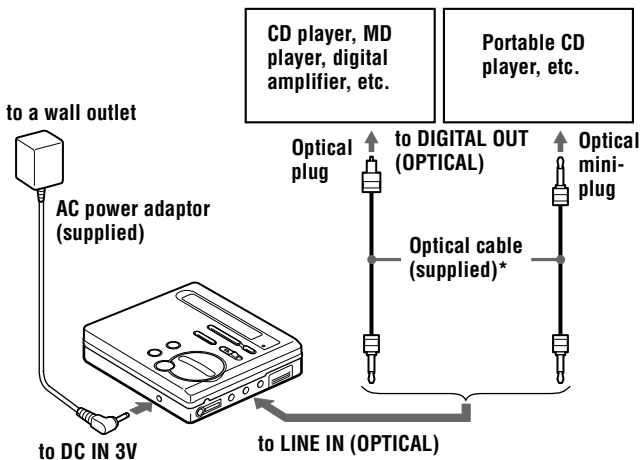

* The supplied cable consists of one or the other of these cables. The shape of the plugs on the supplied cable may differ, depending on where the recorder was purchased.

2

Insert a recordable MD.

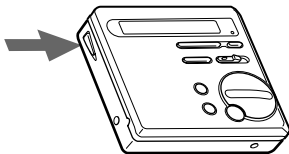

① Press OPEN to open the lid.

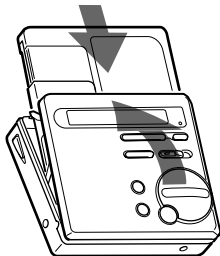

② Insert a recordable MD with the label side facing front, and press the lid down to close.

3

Record an MD.

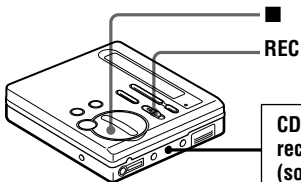

① Slide REC to the right.
REC indication lights up in the display and recording starts.

② Play the source you want to record.

To stop recording, press ■.

After you press ■, the recorder will automatically turn off after:

- about 5 minutes when using AC power adaptor.
- about 10 seconds when using batteries.

Notes

- “Data Save” or “TOC Edit” flashes while data of the recording (the track’s start and end points, etc.) is being recorded. Do not move or jog the recorder or disconnect the power source while the indication is flashing in the display.
- The lid does not open until “TOC Edit” disappears in the display.

To	Press
Record from the end of the previous recording	END SEARCH and slide REC.
Record partway through the previous recording	▶, ▶▶ or ◀◀ to find the start point of recording and press ■ to stop. Then slide REC.
Pause	¹⁾ Press again to resume recording.
Remove the MD	■ and open the lid. ²⁾ (The lid does not open while “TOC Edit” flashing in the display.)

¹⁾ A track mark is added at the point where you press || again to resume recording while pausing; thus the remainder of the track will be counted as a new track.

²⁾ Once you open the lid, the point to start recording will change to the beginning of the first track. Check the point to start recording on the display.

If the recording does not start

- Make sure the recorder is not locked (page 37).
- Make sure the MD is not record-protected (page 58).
- Premastered MDs cannot be recorded over.

For models supplied with the AC plug adaptor

If the AC power adaptor does not fit the wall outlet, use the AC plug adaptor.

Notes

- If the power supply is disrupted (i.e. the battery is removed or becomes exhausted or the AC power adaptor is disconnected) during a recording or editing operation, or while “TOC Edit” appears in the display, then it will not be possible to open the lid until power is restored.
- You can make a digital recording only from an optical type output.
- When recording from a portable CD player, play it on AC power and disable the anti-skip function (such as ESP*).

- Digital output may be disabled on some portable CD players when the player is not run on AC power.

* Electronic Shock Protection



- The level of the recorded sound is adjusted automatically.
- You can monitor the sound during recording. Connect the supplied headphones with remote control to 1 and adjust the volume by pressing VOL +/- . This does not affect the recording level.

Playing an MD right away!

To use the recorder on a rechargeable battery or dry battery, see “Power sources” (page 53).

1

Make connections.

(Insert the cables firmly and completely into the appropriate jacks.)

to a wall outlet

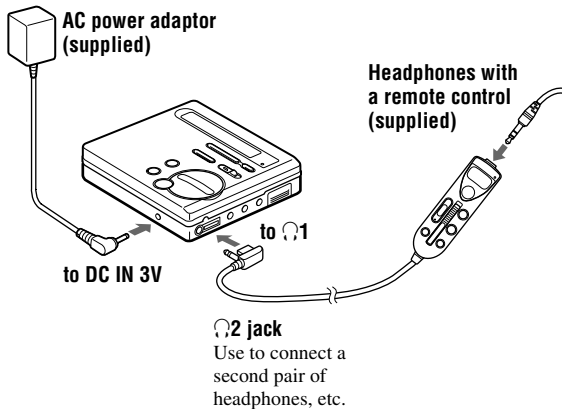

2 Insert an MD.

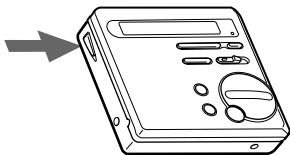

- ① Press OPEN to open the lid.

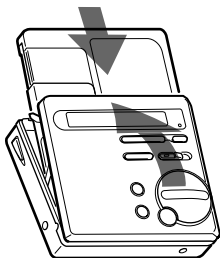

- ② Insert an MD with the label side facing front, and press the lid to close.

3 Play an MD.

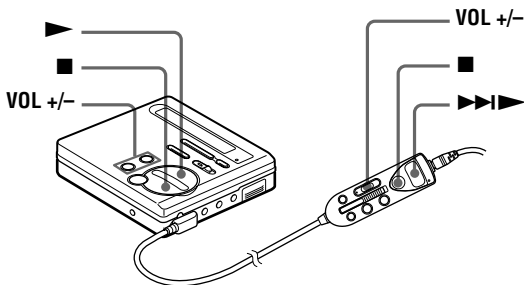

- ① Press ► (►►► on the remote control).

A short beep sounds in the headphones when you operate on the remote control.

- ② Press VOL +/- to adjust the volume.

The volume will be shown in the display.

To stop play, press ■.

A long beep sounds in the headphones when you operate on the remote control.

Playback starts from the point you last stopped playing.

After you press ■, the recorder will automatically turn off after:

- about 5 minutes when using AC power adaptor.
- about 10 seconds when using batteries.

To	Press (Beeps in the headphones)
Find the beginning of the current track	⏮ once (⏮ on the remote control). (Three short beeps)
Find the beginning of the next track	⏭ once (⏭ on the remote control). (Two short beeps)
Pause	⏸ (Continuous short beeps) Press ⏸ again to resume play.
Go backwards while playing ¹⁾	keep pressing ⏮ (⏮ on the remote control)
Go forward while playing ¹⁾	keep pressing ⏭ (⏭ on the remote control)
Remove the MD	■ and open the lid. ²⁾

¹⁾ To go backward or forward quickly without listening, press ⏸ and keep pressing ⏮ or ⏭ (⏮ or ⏭ on the remote control).

²⁾ Once you open the lid, the point to start play will change to the beginning of the first track.

If the play does not start

Make sure the recorder is not locked (page 37).

When using optional headphones

- Use only headphones with stereo mini plugs.
You cannot use headphones with micro plugs.

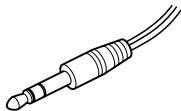

Stereo mini plug

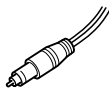

Micro plug

- In addition to the $\Omega 1$ jack, you can connect headphones to the $\Omega 2$ jack as well.



Playback will switch automatically between stereo and monaural according to the sound source.

Notes

- To prevent recorder malfunction, do not use a remote control that was supplied with another Sony portable MD model.
- The sound may skip during playback when the recorder is exposed to continuous vibration, such as while jogging.

Two ways of connecting to a sound source

The input jack of this recorder works as both digital and analog input jacks. Connect the recorder to a CD player or a cassette recorder using either digital (optical) input or analog (line) input. To record, see “Recording an MD right away!” (page 8) to record using digital (optical) input, and “Recording with analog input (line cable required)” (page 18) to record using analog (line) input.

Difference between digital (optical) and analog (line) inputs

Difference	Digital (optical) input	Analog (line) input
Connectable source	Equipment with a digital (optical) output jack	Equipment with an analog (line) output jack
Usable cord	Optical cable (with an optical or an optical-mini plug)(page 8)	Line cable (with 2 phono plugs or a stereo-mini plug)(page 18)
Signal from the source	Digital	Analog Even when a digital source (such as a CD) is connected, the signal sent to the recorder is analog.

Difference	Digital (optical) input	Analog (line) input
Recorded track numbers	<p>Marked (copied) automatically</p> <ul style="list-style-type: none"> • at the same positions as the source. • after more than 2 seconds of blank or low-level segment¹⁾. • when the recorder is paused while recording. <p>You can erase unnecessary marks after recording. (“Erasing a track mark”, page 45).</p>	<p>Marked automatically</p> <ul style="list-style-type: none"> • after more than 2 seconds of blank or low-level segment. • when the recorder is paused while recording. <p>You can erase unnecessary marks after recording (“Erasing a track mark”, page 45).</p>
Recorded sound level	<p>Same as the source. Can also be adjusted manually (Digital REC level control) (“Adjusting the recording level manually (Manual recording)”, page 23).</p>	<p>Adjusted automatically. Can also be adjusted manually (“Adjusting the recording level manually (Manual recording)”, page 23).</p>

¹⁾ When recording a CD or an MD, track numbers are automatically marked in the order of the original disc.

Note

Track marks may be copied incorrectly:

- when you record from some CD players or multi disc players using digital (optical) input.
- when the source is in shuffle or program play mode while recording using digital (optical) input. In this case, play the source in normal play mode.
- when recording BS or CS programs through digital (optical) input.

Recording with analog input (line cable required)

The sound will be sent from the connected equipment as an analog signal but will be recorded digitally on the disc.

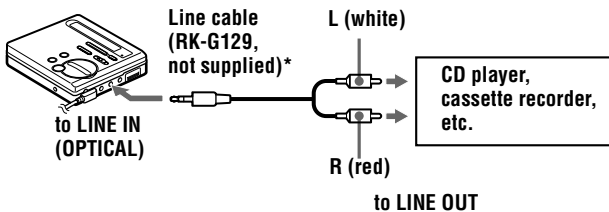

* Use the connecting cords without an attenuator. To connect to a portable CD player having a stereo mini-jack, use the RK-G136 connecting cord (not supplied).

1 Insert a recordable MD and start recording.

For recording operations, see “Recording an MD right away!” (page 8). To record from a portable CD player, set the CD player to pause and then start recording.

LINE IN (OPTICAL) jack is for both digital and analog input

The recorder automatically recognizes the type of line cable and switches to digital or analog input.

To start/stop recording in sync with the source player (Synchro-recording)

You can easily make digital recordings of a digital source on an MD. Before synchro-recording, make connections to the digital source with a digital cable, and insert a recordable MD.

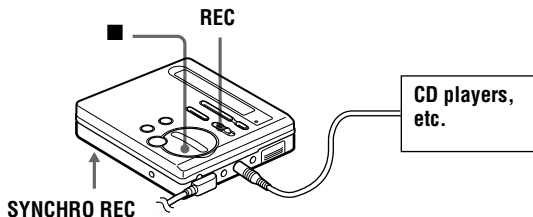

- 1** Slide SYNCHRO REC on the bottom of the recorder to ON. "SYNC" appears in the display.

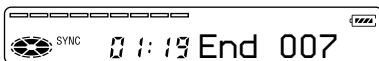

"SYNC" doesn't appear if optical cable is not connected to the recorder.

- 2** Slide REC to the right.
The recorder stands by for recording.
- 3** Play the source sound.
The recorder starts recording when it receives the playing sound.

To stop recording, press ■.



- You cannot pause manually during synchro-recording.
- When there is no sound from the player for more than 3 seconds during synchro-recording, the recorder goes into the standby mode automatically. When the sound comes from the player again, the recorder resumes synchro-recording. If the recorder is kept in the standby mode for 5 minutes or longer, the recorder stops automatically.

Notes

- Do not switch SYNCHRO REC after step 3. Recording may not be done properly.
- When recording in monaural, follow steps 1 to 3 of “Recording in monaural for double the normal recording time” (page 22), and then do steps 1 and 3 of synchro-recording.
- Even when there is no recorded sound on the sound source, there may be cases when recording does not pause automatically during synchro-recording due to the noise level emitted from the sound source.
- If a silent portion is encountered for 2 seconds or more during synchro-recording, a new track mark is automatically added at the point where the silent portion ends.
- Synchro-recording cannot be done if the connecting cord is not an optical cable, or if the cable is connected to the MIC (PLUG IN POWER) jack.
- You cannot adjust the recording level manually during synchro-recording.

Recording from a microphone

Connect a stereo microphone (ECM-717, ECM-MS907, ECM-MS957, etc.; not supplied) to the MIC (PLUG IN POWER) jack.

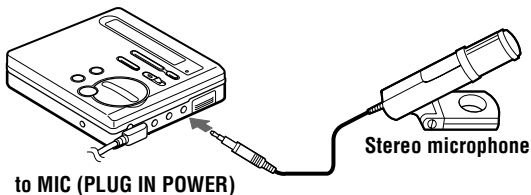

- 1 Insert a recordable MD and start recording.

Slide REC to the right.

For other operations, see “Recording an MD right away!” (page 8).

Notes

- You cannot record through the microphone while an optical cable is connected to the LINE IN (OPTICAL) jack. The recorder automatically switches input in the following order; optical input, microphone input, and analog input.
- The microphone may pick up the operating sound of the recorder itself. Use the microphone away from the recorder in such cases.

Recording in monaural for double the normal recording time

For longer recordings, choose to record in monaural. The recording time becomes double the normal.

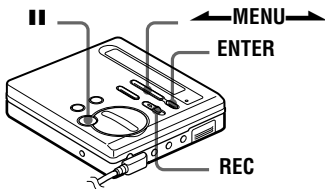

- 1** While pressing **||**, slide REC to the right.
The recorder stands by for recording.
- 2** Press ENTER, press **←MENU→** repeatedly until “REC MODE” flashes in the display, and then press ENTER again.
- 3** Press **←MENU→** repeatedly until “Mono REC” flashes in the display, and then press ENTER.
To switch back to stereo recording, press ENTER while “Stereo REC” flashes in the display.
- 4** Press **||** again to start recording.
- 5** Play the sound source.

To stop recording, press ■.

The recorder switches back to stereo recording when you record the next time.

Notes

- If you record a stereo source in monaural, the sounds from left and right will be mixed.
- You cannot record in monaural if SYNCHRO REC is slid to ON. If you are recording digital input, make sure to slide SYNCHRO REC to OFF before you begin recording.
- The MDs recorded in monaural can be played back only with an MD player/recorder that has the monaural playing function.
- Sound recorded through digital (optical) input can be monitored in stereo through headphones, etc.

Adjusting the recording level manually (Manual recording)

When you record, the sound level is adjusted automatically. If necessary, you can set the level manually.

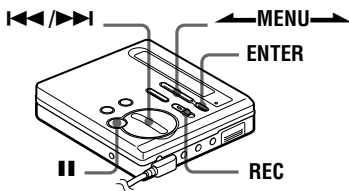

Note

Adjust the recording level while the recorder is in standby mode. You cannot adjust it while recording.

- 1** While holding down **II**, slide **REC** to the right.
The recorder stands by for recording.
- 2** Press **ENTER**, press **←MENU→** repeatedly until “RecVolume” flashes in the display, and then press **ENTER** again.
- 3** Press **←MENU→** repeatedly until “ManualREC” flashes in the display, and then press **ENTER**.



To switch back to the automatic control, Press **←MENU→** repeatedly until “Auto REC” flashes in the display, and then press **ENTER**.

- 4** Play the source.

continued

- 5** While observing the level meter in the display, adjust the recording level by pressing **←MENU→**, **▶▶| (+)** or **◀◀| (-)**.

Set the level so that the level meter reaches around **-12 dB** mark above the display window.

If the sound is too high, lower the recording level until the level meter just barely reaches the **OVER** mark above the display window.

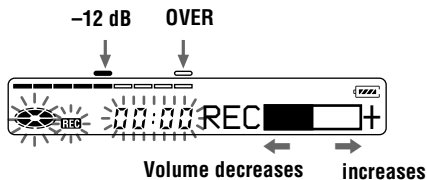

Recording doesn't start in this step.

If your source is an externally connected component, be sure to cue the source to the beginning of the material to be recorded before you start playback.

- 6** Press **||** again to start recording.

To stop recording, press ■.

The recording level control is switched back to automatic control when you record the next time.

Notes

- The recording level cannot be adjusted while recording is in progress. If you want to adjust the recording level after you have started the recording, press **||** to pause the recorder. Then do the procedure from step 5.
- You cannot adjust the recording level manually during synchro-recording.

Checking the remaining time or the recording position

You can check the remaining time, track number, etc. when recording or during stop.

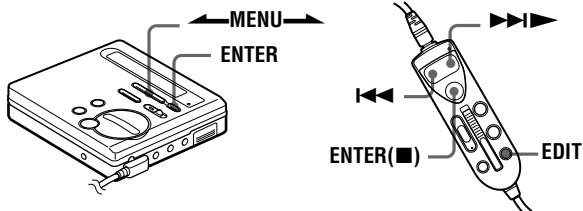

On the recorder

- 1** While the recorder is recording or stopped, press ENTER, press \leftarrow MENU \rightarrow repeatedly until "DISPLAY" flashes in the display, and then press ENTER again.
- 2** Press \leftarrow MENU \rightarrow repeatedly until the information you want flashes in the display.
Each time you press MENU \rightarrow , the display changes as follows.

continued

Display window on the recorder

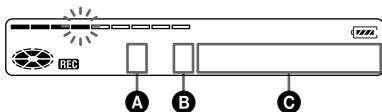

While recording

A ¹⁾	B ²⁾	C
1	2	LapTime (elapsed time)
2	2	RecRemain (remaining time for recording)

¹⁾ Display order

²⁾ Number of displayed items

In stop mode

A ¹⁾	B ²⁾	C
1	3	LapTime (elapsed time)
2	3	RecRemain (remaining time for recording)
3	3	AllRemain (remaining time after the current location)

¹⁾ Display order

²⁾ Number of displayed items

3 Press ENTER.

The display changes as follows.

Display window on the recorder

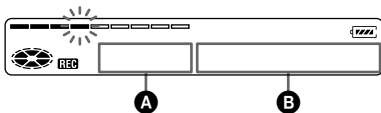

While recording

A	B
Elapsed time	Track number
Remaining time for recording	Track number

In stop mode

A	B
Elapsed time	Track number
Remaining time for recording	Track name ¹⁾
Remaining time after the current location	Disc name ¹⁾

¹⁾ Appears only if the track has been labeled.



If you want to check the playing position or track name while playing, see page 35.

On the remote control

There is no display window on the remote control. Menu items should be viewed in the display window on the recorder.

- 1** While the recorder is recording or stopped, press EDIT for 2 seconds or more, press **⏮** or **⏭** repeatedly until “DISPLAY” flashes in the display, and then press ENTER (■).
- 2** Press **⏮** or **⏭** repeatedly until the information you want flashes in the display.
Each time you press **⏭**, the display changes as step 2 of “On the recorder” (page 26).
- 3** Press ENTER (■).
The display changes as step 3 of “On the recorder” (page 27).

Selecting a track directly

You can select a desired track directly.

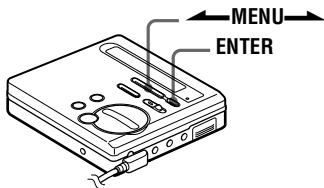

- 1 Press **←MENU→** repeatedly until the desired track appears in the display, and then press **ENTER**.

The selected track name appears in the display and the recorder starts playing by pressing **ENTER**. If the track has no name, the track number appears in the display.



If you do step 1 while the recorder is shuffling the tracks, shuffle play starts from the track that you selected.

Playing tracks repeatedly

You can play tracks repeatedly in three ways — all repeat, single repeat, and shuffle repeat.

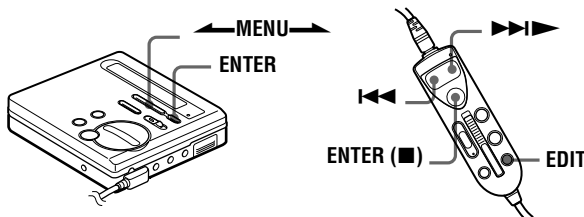

On the recorder

- 1** While the recorder is playing or stopped, press **ENTER**, press **←MENU→** repeatedly until “PLAY MODE” flashes in the display, and then press **ENTER** again.
- 2** Press **←MENU→** repeatedly to select the play mode, and then press **ENTER**.

Each time you press **MENU→**, the display item indicated by **B** changes as shown in the table below.

Pressing **ENTER** while **B** is flashing causes the play mode to change.

The new mode then appears in the window indicated by **A**.

Display window on the recorder

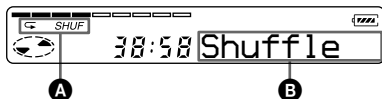

Indication A/B	Play mode
—/No Repeat	All the tracks are played once.
↺/AllRepeat	All the tracks are played repeatedly.
↺ 1/1 Repeat	A single track is played repeatedly.
↺ SHUF /Shuffle	After the currently selected track finishes playing, the remaining tracks are played repeatedly in random order.

On the remote control

There is no display window on the remote control. Menu items should be viewed in the display window on the recorder.

- 1** While the recorder is playing or stopped, press EDIT for 2 seconds or more, press **⏮** or **⏭** repeatedly until “PLAY MODE” flashes in the display, and then press ENTER (■).
- 2** Press **⏮** or **⏭** repeatedly to select the play mode, and then press ENTER (■).
Each time you press **⏭**, the display changes as step 2 of “On the recorder” (page 30).

Emphasizing bass (DIGITAL MEGA BASS)

The Mega Bass function intensifies low frequency sound for richer quality audio reproduction. It affects only the sound from the headphones.

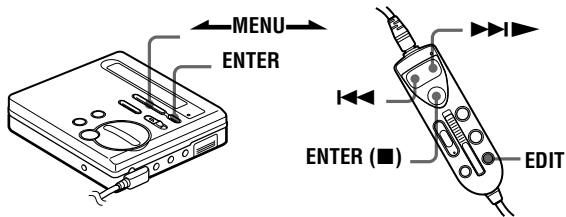

On the recorder

- 1 Press ENTER, press \leftarrow MENU \rightarrow repeatedly until "MEGA BASS" flashes in the display, and then press ENTER again.
- 2 Press \leftarrow MENU \rightarrow to select the item, and then press ENTER.

Each time you press MENU \rightarrow , **A** and **B** change as follows.

Display window on the recorder

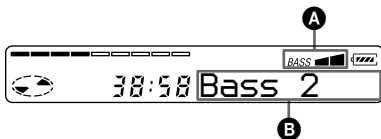

Indication A/B	Play mode
—/BASS 0	Normal play
BASS █/BASS 1	Mega Bass (moderate effect)
BASS ███/BASS 2	Mega Bass (strong effect)

Notes

- If the sound becomes distorted when emphasizing bass, turn down the volume.
- The Mega Bass function does not affect the sound being recorded.

On the remote control

There is no display window on the remote control. Menu items should be viewed in the display window on the recorder.

- 1** While the recorder is playing or stopped, press EDIT for 2 seconds or more, press **⏮** or **⏭** repeatedly until “MEGA BASS” flashes in the display, and then press ENTER (■).
- 2** Press **⏮** or **⏭** repeatedly to select the item, and then press ENTER (■).
Each time you press **⏭**, the display changes as step 2 of “On the recorder” (page 32).

Notes

- If the sound becomes distorted when emphasizing bass, turn down the volume.
- The Mega Bass function does not affect the sound being recorded.

Protecting your hearing (AVLS)

The AVLS (Automatic Volume Limiter System) function keeps down the maximum volume to protect your ears.

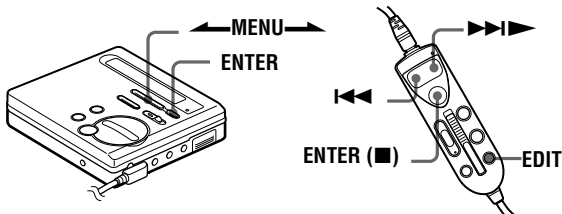

On the recorder

- 1** Press ENTER, press \leftarrow MENU \rightarrow repeatedly until “AVLS” flashes in the display, and then press ENTER again.
- 2** Press \leftarrow MENU \rightarrow repeatedly until “AVLS ON” flashes in the display, and then press ENTER.

When you try to turn the volume too high, “AVLS” appears in the display. The volume is kept to a moderate level.

On the remote control

There is no display window on the remote control. Menu items should be viewed in the display window on the recorder.

- 1** While the recorder is playing or stopped, press EDIT for 2 seconds or more, press \ll or \gg repeatedly until “AVLS” flashes in the display, and then press ENTER (■).
- 2** Press \ll or \gg repeatedly until “AVLS ON” flashes in the display, and then press ENTER (■).

When you try to turn the volume too high, “AVLS” appears in the display. The volume is kept to a moderate level.

Checking the remaining time or the playing position

You can check the track name, disc name, etc. during playback.

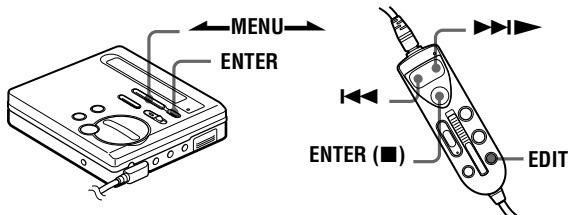

On the recorder

- 1 While the recorder is playing, press ENTER, press \leftarrow MENU \rightarrow repeatedly until "DISPLAY" flashes in the display, and then press ENTER again.
- 2 Press \leftarrow MENU \rightarrow repeatedly until the information you want flashes in the display.
Each time you press MENU \rightarrow , the display changes as follows.

Display window on the recorder

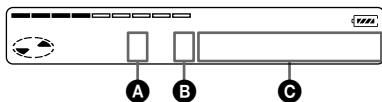

A ¹⁾	B ²⁾	C
1	3	LapTime (elapsed time)
2	3	1 Remain (remaining time of the current track)
3	3	AllRemain (remaining time after current location)

¹⁾ Display order

²⁾ Number of displayed items

continued

3 Press ENTER.

The display changes as follows.

Display window on the recorder

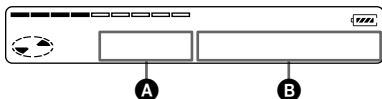

A	B
Elapsed time	Track number
Remaining time of the current track	Track name ¹⁾
Remaining time after the current location	Disc name ¹⁾

¹⁾ Appears only if the track has been labeled.



If you want to check the remaining time or the recording position while recording or in stop mode, see page 25.

On the remote control

There is no display window on the remote control. Menu items should be viewed in the display window on the recorder.

- 1 While the recorder is playing or stopped, press EDIT for 2 seconds or more, press **⏮** or **⏭** repeatedly until “DISPLAY” flashes in the display, and then press ENTER (■).
- 2 Press **⏮** or **⏭** repeatedly until the information you want flashes in the display.
Each time you press **⏭**, the display changes as step 2 of “On the recorder” (page 35).
- 3 Press ENTER (■).
The display changes as step 3 of “On the recorder” (page 36).

Locking the controls (HOLD)

To prevent the buttons from being accidentally operated when you carry the recorder, use this function.

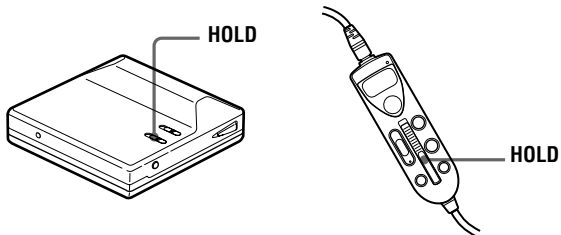

- 1 Slide HOLD in the direction of the .

On the recorder, slide HOLD to lock the controls of the recorder.
On the remote control, slide HOLD to lock the controls of the remote control.

Slide HOLD in the opposite direction of the arrow to unlock the controls.

Connecting to a stereo system

Connect the \odot 1 (or \odot 2) jack of the recorder to the LINE IN jacks of an amplifier or a tape player with a line cable (RK-G129 or RK-G136, not supplied). The output is analog. The recorder plays the MD digitally and sends analog signals to the externally connected equipment.

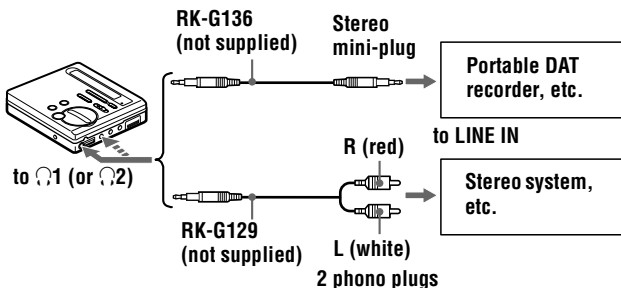

When connecting a line cable (not supplied) to the \odot 1 (or \odot 2) jack of the recorder, be sure to set the “BEEP” setting to “BEEP OFF”. This keeps the beep sound out of the recorded signal or the output from the externally connected equipment.

- 1 Press ENTER, press \leftarrow MENU \rightarrow repeatedly until “BEEP” flashes in the display, and then press ENTER again.
- 2 Press MENU \rightarrow repeatedly until “BEEP OFF” flashes in the display, and then press ENTER.

Notes

- Even when connecting to the externally connected equipment, the Mega Bass function is operative. If you do not want the effect of the Mega Bass function on your recording or the output from the externally connected equipment, set “MEGA BASS” to “BASS 0” (page 32).
- When recording to an externally connected equipment, press VOL + repeatedly to raise the volume level to maximum, which is optimum for recording to an externally connected equipment. If, however, this level produces distortion in the recording, press VOL – several times to lower the level (to that shown in the illustration below).



- When recording through a line cable connected to L1 or L2 (headphone jack), refrain from connecting another line cable to the other headphone jack (or disconnecting one that is already connected). Doing this may produce distortion in your recording.
- To switch back to the beep sound operative again, select “BEEP ON” in step 2.



In addition to the L1 jack, you can connect a line cable to the L2 jack as well.

Editing recorded tracks

You can edit your recordings by adding/erasing track marks or labeling tracks and MDs. Premastered MDs cannot be edited.

Notes on editing

- Do not move or jog the recorder while “TOC Edit”* is flashing in the display.
- You cannot edit tracks on an MD that is record-protected. Before editing tracks, close the tab on the side of the MD (page 58).
- If you perform an editing operation while playing, be sure not to turn the power off until “TOC Edit” disappears in the display.
- The lid does not open until “TOC Edit” disappears in the display after editing.

* TOC = Table of Contents

Erasing tracks

To erase a track

Note that once a recording has been erased, you cannot retrieve it. Make sure of the track you are erasing.

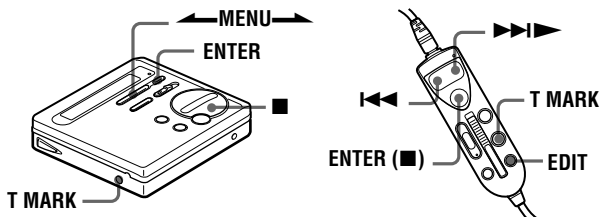

On the recorder

- 1 While playing the track you want to erase, press ENTER so that “EDIT” flashes in the display, and then press ENTER again. “: Name” flashes in the display, and the recorder plays the selected track repeatedly.

2 Press **←MENU→** repeatedly until “: Erase” flashes in the display, and then press ENTER.

“Erase OK?” and “PushENTER” appear alternately in the display.

To cancel erasing, press **■** or T MARK.

3 Press ENTER again.

The track is erased and the next track starts to play. All the tracks after the one erased are automatically renumbered.

On the remote control

There is no display window on the remote control. Menu items should be viewed in the display window on the recorder.

1 While playing the track you want to erase, press EDIT for 2 seconds or more so that “EDIT” flashes in the display, and then press ENTER (**■**).

“: Name” flashes in the display, and the recorder plays the selected track repeatedly.

2 Press **⏮** or **⏭** repeatedly until “: Erase” flashes in the display, and then press ENTER (**■**).

“Erase OK?” and “PushENTER” appear alternately in the display.

To cancel erasing, press EDIT for 2 seconds or more, or press T MARK.

3 Press ENTER (**■**) again.

The track is erased and the next track starts to play. All the tracks after the one erased are automatically renumbered.

To erase a part of a track

Add track marks at the beginning and the end of the part you want to erase, then erase the part (page 44).

To erase the whole disc

You can quickly erase all the tracks and data of the MD at the same time.

Note that once a recording has been erased, you cannot retrieve it. Be sure to check the contents of the disc you want to erase.

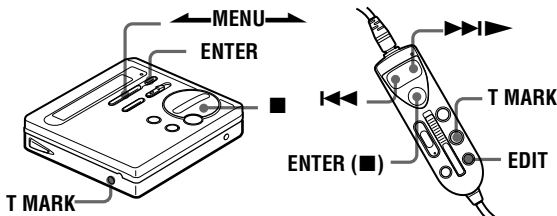





On the recorder

- 1** While the recorder is stopped, press ENTER so that “EDIT” flashes in the display, and then press ENTER again.
“: Name” flashes in the display.
- 2** Press \leftarrow MENU \rightarrow repeatedly until “: Erase” flashes in the display, and then press ENTER.
“All Erase?” and “PushENTER” appear alternately in the display.
To cancel erasing, press ■ or T MARK.
- 3** Press ENTER again.
“TOC Edit” flashes in the display, and all the tracks will be erased.
When erasing is complete, “BLANKDISC” appears in the display.

On the remote control

There is no display window on the remote control. Menu items should be viewed in the display window on the recorder.

- 1** While the recorder is stopped, press EDIT for 2 seconds or more so that “EDIT” flashes in the display, and then press ENTER (■).
“: Name” flashes in the display.
- 2** Press  or  repeatedly until “: Erase” flashes in the display, and then press ENTER (■).
“Erase OK?” and “PushENTER” appear alternately in the display.
To cancel erasing, press EDIT for 2 seconds or more, or press T MARK.
- 3** Press ENTER (■).
“TOC Edit” flashes in the display and all the tracks will be erased.
When erasing is complete, “BLANKDISC” appears in the display.

Adding a track mark

You can add track marks so that the part after the new track mark is counted as a new track.

The track numbers will increase as follows.

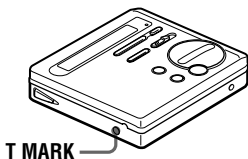
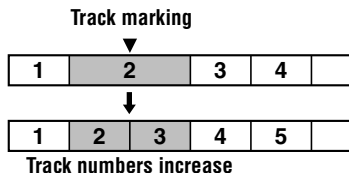

- 1** While playing or pausing an MD, press T MARK on the recorder at the point you want to mark.
“MARK ON” appears in the display, and a track mark is added.
The track number will increase by one.

To add track marks while recording

Press T MARK on the recorder at the point you want to add a track mark.

Notes

- You cannot add track marks during synchro-recording.
- T MARK on the remote control does not function during playback.

Erasing a track mark

When you record with analog (line) input, unnecessary track marks may be recorded where recording level is low. You can erase a track mark to combine the tracks before and after the track mark. The track numbers will change as follows.

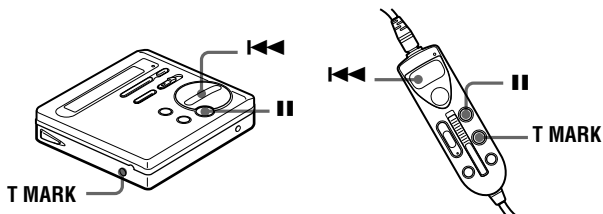
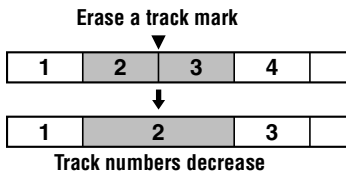

- 1** While playing the track with the track mark you want to erase, press **II** to pause.
- 2** Find the track mark by pressing **⏮** slightly.
For example, to erase the third track mark, find the beginning of the third track. “00:00” appears in the display.
“MARK” appears in the display for 2 seconds.
- 3** Press **T MARK** to erase the mark.
“MARK OFF” appears in the display. The track mark is erased and the two tracks are combined.



When you erase a track mark, name assigned to the mark is also erased.

Moving recorded tracks

You can change the order of the recorded tracks.

Example

Move track C from the third to the second track.

Before moving

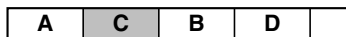
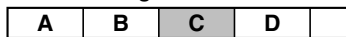

After moving

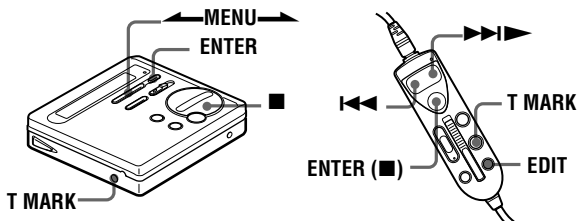

On the recorder

- 1** While playing the track you want to move, press ENTER so that “EDIT” flashes in the display, and then press ENTER again. “ Name” flashes in the display and the recorder plays the selected track repeatedly.
- 2** Press \leftarrow MENU \rightarrow repeatedly until “ Move” flashes in the display, and then press ENTER. For the example above, “MV 003 \rightarrow 003” appears in the display.
- 3** Press \leftarrow MENU \rightarrow to select the destination track number. For the example above, “MV 003 \rightarrow 002” appears in the display. To cancel moving, press \blacksquare or T MARK.

- 4** Press ENTER again.
The track moves to the selected destination track.
-

On the remote control

There is no display window on the remote control. Menu items should be viewed in the display window on the recorder.

- 1** While playing the track you want to move, press EDIT for 2 seconds or more so that “EDIT” flashes in the display, and then press ENTER (■).
“🎵: Name” flashes in the display and the recorder plays the selected track repeatedly.
- 2** Press ⏮ or ⏭ repeatedly until “🎵: Move” appears in the display.
- 3** Press ENTER (■).
For the example on page 46, “MV 003 → 003” appears in the display.
- 4** Press ⏮ or ⏭ repeatedly to select the destination track number.
For the example on page 46, “MV 003 → 002” appears in the display.
To cancel moving, press EDIT for 2 seconds or more, or press T MARK.
- 5** Press ENTER (■).
The selected track moves just before the destination track.

Labeling recordings

You can name discs while the recorder is stopped, tracks while the recorder is playing, and both while the recorder is recording. Each name can be as long as 200 letters.

Each disc can hold up to 1700 alphanumeric letters during playback or stop.

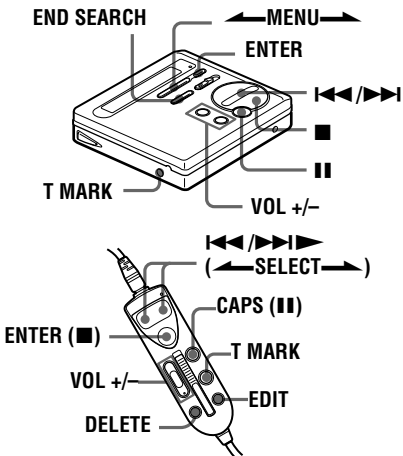

On the recorder

Labeling a disc during stop

- 1 Insert a disc.
- 2 Press ENTER so that “EDIT” flashes in the display, and then press ENTER again.
“: Name” flashes in the display.

- 3** Press ENTER.
The disc is ready to be labeled.

- 4** Press **←MENU→** repeatedly to select a letter and press ENTER.
The selected letter stops flashing and the cursor moves to the next input position.

Press	To
II	Switch between capital letters, small letters and marks / numbers.
VOL +/-	Move the cursor to the left or right.
◀◀/▶▶	Change the letter to the one before / next one.
END SEARCH/ VOL +	Insert a blank space to type in a new letter pressing both buttons together.
END SEARCH/ VOL -	Delete a letter and move back all following letters to the left pressing both buttons together.
■	Cancel labeling.
T MARK	Cancel labeling.

- 5** Repeat step 4 and enter all characters of the label name.
To cancel labeling, press **■** or T MARK
- 6** Press ENTER for 2 seconds or more.
The track or disc is labeled.





Labeling a track during playback

- 1** Insert a disc and play the track you want to label.
- 2** Press ENTER so that “EDIT” flashes in the display, and then press ENTER again.
“: Name” flashes in the display.
- 3** Press ENTER.
The track is ready to be labeled.

continued

- 4** Follow steps 4 to 6 of “Labeling a disc during stop”.

Labeling a track or a disc during recording

- 1** While recording, press ENTER so that “EDIT” flashes in the display, and then press ENTER again.
“: Name” flashes in the display.
- 2** To label a track, press ENTER again.
To label a disc, press MENU repeatedly until
“: Name” flashes in the display, then press ENTER.
The track or disc is ready to be labeled.
- 3** Follow steps 4 to 6 of “Labeling a disc during stop”.

To cancel labeling, press  or T MARK.



Note

When the recording is stopped while labeling a track or a disc during recording, or when the recording moves on to the next track while labeling a track, the input at that point is entered automatically.

On the remote control

There is no display window on the remote control. Menu items should be viewed in the display window on the recorder.

Labeling a disc during stop

- 1** Insert a disc.
- 2** Press EDIT for 2 seconds or more so that “EDIT” flashes in the display, and then press ENTER ().
“: Name” flashes in the display.
- 3** Press ENTER ().
The disc is ready to be labeled.

- 4** Press **◀◀** or **▶▶** to select a letter and press **ENTER (■)**.
The selected letter stops flashing and the cursor moves to the next input position.





Press	To
CAPS (II)	Switch between capital letters, small letters and marks / numbers.
VOL +/-	Move the cursor to the left or right.
◀◀/▶▶ (◀SELECT▶)	Change the letter to the one before / next one.
EDIT	Insert a blank space to type in a new letter by pressing within 2 seconds. Cancel labeling by pressing for 2 seconds or more.
DELETE	Delete a letter and move back all following letters to the left.
T MARK	Cancel labeling

- 5** Repeat step 4 and enter all characters of the label name.
To cancel labeling, press **EDIT** for 2 seconds or more or press **T MARK**.
- 6** Keep pressing **ENTER (■)** for 2 seconds or more.
The track or disc is labeled.

Labeling a track during playback

- 1** Insert a disc and play the track you want to label.
- 2** Press **EDIT** for 2 seconds or more so that “**EDIT**” flashes in the display, and then press **ENTER (■)**.
“**♪: Name**” flashes in the display.
- 3** Press **ENTER (■)**.
The track is ready to be labeled.
- 4** Follow steps 4 to 6 of “Labeling a disc during stop” (page 50).

Labeling a track or a disc during recording

- 1** While recording, press EDIT for 2 seconds or more so that “EDIT” flashes in the display, and then press ENTER (■).
“: Name” flashes in the display.
- 2** To label a track, press ENTER (■) again.
To label a disc, press  or  repeatedly until “: Name” flashes in the display, then press ENTER (■).
The track or disc is ready to be labeled.
- 3** Follow steps 4 to 6 of “Labeling a disc during stop” (page 50).

To cancel labeling, press EDIT for 2 seconds or more or press T MARK.

Note

When the recording is stopped while labeling a track or a disc during recording, or when the recording moves on to the next track while labeling a track, the input at that point is entered automatically.

Available characters

- Capital and small letters of the English alphabet
- Numbers 0 to 9
- ! " # \$ % & () * . ; < = > ?
@ _ ` + - ' , / : _ (space)

Relabeling recordings

Follow the steps corresponding to the labeling method until the disc or track is ready to be labeled. Enter a new character over the one you want to change, then press ENTER (■ for 2 seconds or more on the remote control).

Notes

- You cannot relabel premastered MDs or label MDs that have not been recorded.
- The recorder is able to display, but cannot label using Japanese “Katakana” characters.
- The recorder cannot rewrite a disc or track name of more than 200 letters that was created by another device.

Power sources

You can use the recorder on house current or as follows.

In the recorder ...

- a nickel cadmium rechargeable battery NC-WMAA (supplied)
- LR6 (size AA) alkaline dry battery (not supplied)

It is preferable to use the recorder on house current when recording for a long time.

Charging the nickel cadmium rechargeable battery

Before using the supplied NC-WMAA nickel cadmium rechargeable battery for the first time, charge it in the recorder.

- 1 Connect the supplied AC power adaptor.

to wall output

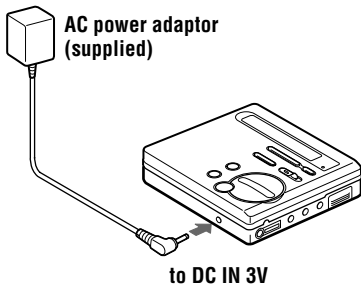

continued

2 Insert the NC-WMAA into the recorder and close the lid.

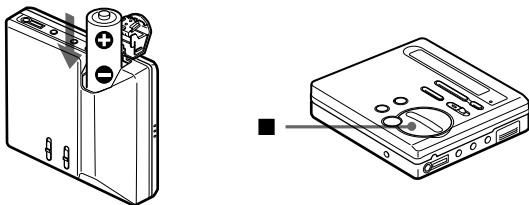

3 Press ■.

“Charging” flashes,  appears in the display, and charging starts.

Full charging of a completely discharged rechargeable battery takes about 3 hours. To cancel charging, press ■.

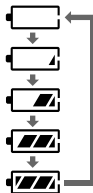

Notes

- If you press ■ immediately after charging has completed, charging will begin again, even though the battery is already fully charged.
- Charging stops when you try to operate the recorder during charging.
- Be sure to use the supplied AC power adaptor.
- Charging time may vary depending on the battery condition.
- When a rechargeable battery is charged for the first time or charged after a long period of disuse, battery life may be shorter than usual. Repeat discharging and recharging a few times. The battery life should return to normal.
- When the battery life of a fully charged rechargeable battery becomes about half the normal life, replace it.
- When carrying the rechargeable battery, keep it in the supplied carrying case. It is dangerous to carry the battery out of its case in your pocket or a bag together with metallic objects such as key rings, as this may cause a short circuit.
- Remove the rechargeable battery from the recorder when it is not to be used for a long time.

Using on a battery

The recorder accepts either a rechargeable nickel cadmium battery (supplied) or an LR6 (size AA) alkaline dry battery. Be sure the rechargeable battery is fully charged.

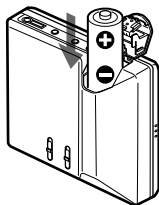

- 1 Insert either a fully charged nickel cadmium rechargeable battery or a LR6 (size AA) alkaline dry battery with correct polarity.

Battery life¹⁾

Batteries	Recording ³⁾	Playback
NC-WMAA nickel cadmium rechargeable battery	Approx. 3 hours	Approx. 6.5 hours
LR6 (size AA) Sony alkaline dry battery ²⁾	Approx. 3 hours ⁴⁾	Approx. 17 hours

- 1) The battery life may be shorter due to operating conditions and the temperature of the location.
- 2) When using a LR6 (SG) Sony “STAMINA” alkaline dry battery (produced in Japan).
- 3) When you record, use a fully charged rechargeable battery.
- 4) Recording time may differ according to the alkaline batteries.

When to replace the battery

When the dry battery or rechargeable battery is weak, flashing  or “LOW BATT” appears in the display. Replace the dry battery or charge the rechargeable battery.

The battery level indicator is approximate.

Note

Stop the recorder before replacing battery.

Precautions

On safety

Do not put any foreign objects in the DC IN 3V jack.

On power sources

- Use house current, nickel cadmium rechargeable battery, LR6 (size AA) battery, or car battery.
- For use in your house: Use the AC power adaptor supplied with this recorder. Do not use any other AC power adaptor since it may cause the recorder to malfunction.

Polarity of the plug

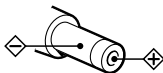

- The recorder is not disconnected from the AC power source (mains) as long as it is connected to the wall outlet, even if the recorder itself has been turned off.
- If you are not going to use this recorder for a long time, be sure to disconnect the power supply (AC power adaptor, dry battery, rechargeable battery, or car battery cord). To remove the AC power adaptor from the wall outlet, grasp the adaptor plug itself; never pull the cord.

On heat build-up

Heat may build up in the recorder if it is used for an extended period of time. In this case, leave the recorder turned off until it cools down.

On installation

- Never use the recorder where it will be subjected to extremes of light, temperature, moisture or vibration.
- Never wrap the recorder in anything when it is being used with the AC power adaptor. Heat build-up in the recorder may cause malfunction or damage.

On the headphones

Road safety

Do not use headphones while driving, cycling, or operating any motorized vehicle. It may create a traffic hazard and is illegal in many areas. It can also be potentially dangerous to play your recorder at high volume while walking, especially at pedestrian crossings. You should exercise extreme caution or discontinue use in potentially hazardous situations.

Preventing hearing damage

Avoid using headphones at high volume. Hearing experts advise against continuous, loud and extended play. If you experience a ringing in your ears, reduce the volume or discontinue use.

Caring for others

Keep the volume at a moderate level. This will allow you to hear outside sounds and to be considerate of the people around you.

On the MiniDisc cartridge

- When carrying or storing the MiniDisc, keep it in its case.
- Do not break open the shutter.
- Do not place the cartridge where it will be subject to light, extreme temperatures, moisture or dust.

On cleaning

- Clean the recorder casing with a soft cloth slightly moistened with water or a mild detergent solution. Do not use any type of abrasive pad, scouring powder or solvent such as alcohol or benzene as it may mar the finish of the casing.
- Wipe the disc cartridge with a dry cloth to remove dirt.
- Dust on the lens may prevent the unit from operating properly. Be sure to close the disc compartment lid after inserting or ejecting an MD.

Notes on batteries

Incorrect battery usage may lead to leakage of battery fluid or bursting batteries. To prevent such accidents, observe the following precautions:

- Install the + and – poles of the batteries correctly.
- Do not try to recharge dry battery.
- When the recorder is not to be used for a long time, be sure to remove the batteries.
- If a battery leak should develop, carefully and thoroughly wipe away battery fluid from the battery compartment before inserting new ones.

On the lid of the battery compartment

The lid of the battery compartment is designed to detach from the main unit when handled with great force. To reattach the lid to the main unit, follow the steps below:

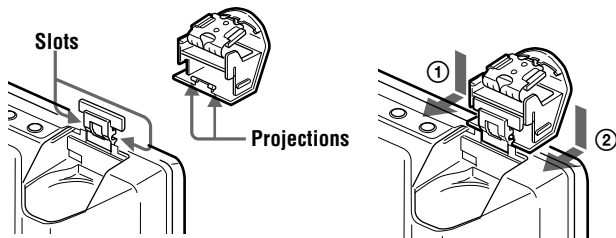

- 1 Place the lid so that the projections on the lid aligned with the slots on the main unit.
- 2 Fit the projection one by one into the slot as shown in the illustration.

Note on mechanical noise

The recorder gives off mechanical noise while operating, which is caused by the power-saving system of the recorder and it is not a problem.

To protect a recorded MD

To record-protect an MD, slide open the tab at the side of the MD. In this position, the MD cannot be recorded or edited. To record again, slide the tab back so the tab is visible.

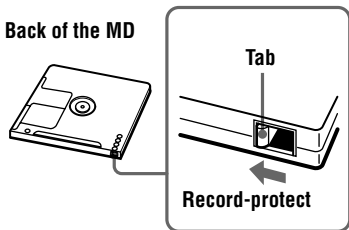

Note on digital recording

This recorder uses the Serial Copy Management System, which allows only first-generation digital copies to be made from premastered software. You can only make copies from a home-recorded MD by using the analog connections.

Premastered software such as CDs or MDs.



↓ **Digital recording**



Home-recorded MD

No digital recording

Recordable MD

If you have any questions or problems concerning your recorder, please consult your nearest Sony dealer. (If a trouble occurred when the disc was in the recorder, we recommend that the disc be left in the recorder when you consult your Sony dealer so that the cause of trouble may be better understood.)

Microphone, record player, tuner, etc (with analog output jacks).

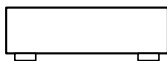

↓ **Analog recording**



Home-recorded MD

↓ **Digital recording**



Recordable MD

No digital recording

Recordable MD

Troubleshooting

Should any problem persist after you have made these checks, consult your nearest Sony dealer.

Symptom	Cause/Solution
The recorder does not work or works poorly.	<ul style="list-style-type: none">• Audio sources may not be securely connected. ➔ Disconnect the audio sources once and connect them again (pages 8, 18).• The HOLD function is turned on (“HOLD” appears in the display when you press an operation button on the recorder). ➔ Disable HOLD by sliding the HOLD switch in the opposite direction of the arrow (page 37).• Moisture has condensed inside the recorder. ➔ Take the MD out and leave the recorder in a warm place with the lid open for several hours until the moisture evaporates.• The rechargeable battery or dry battery is weak (☐ or “LOW BATT” flashes). ➔ Charge the rechargeable battery or replace the dry battery (page 53).• The rechargeable battery or dry battery have been inserted incorrectly. ➔ Insert the battery correctly (page 55).• You pressed a button while the disc indication was rotating quickly. ➔ Wait until the indication rotates slowly.• When recording digitally from a portable CD player, you did not use AC power or did not disable the anti-skip function such as ESP (pages 10, 11).• The analog recording was made using a connecting cord with an attenuator. ➔ Use a connecting cord without an attenuator (page 18).

Symptom	Cause/Solution
The recorder does not work or works poorly.	<ul style="list-style-type: none"> • The AC power adaptor was unplugged during recording or a power outage occurred. • While operating, the recorder received a mechanical shock, too much static, abnormal power voltage caused by lightning, etc. <ul style="list-style-type: none"> ➔ Restart the operation as follows. <ol style="list-style-type: none"> 1 Disconnect all the power sources. 2 Leave the recorder for about 30 seconds. 3 Connect the power source. • The disc is damaged or does not contain proper recording or editing data. <ul style="list-style-type: none"> ➔ Reinsert the disc. If this fails, rerecord.
The lid does not open.	<ul style="list-style-type: none"> • The power sources have been disconnected during recording or editing, or the battery have been exhausted. <ul style="list-style-type: none"> ➔ Set the power sources again, or replace the exhausted battery with new ones.
No sound comes through the headphones.	<ul style="list-style-type: none"> • The headphones plug is not firmly connected. <ul style="list-style-type: none"> ➔ Plug in the plug of the headphones firmly to the remote control. Plug in the plug of the remote control firmly to ①. • Volume is too low. <ul style="list-style-type: none"> ➔ Adjust the volume by pressing VOL +/-. • AVLS is on. <ul style="list-style-type: none"> ➔ Set AVLS to “AVLS OFF” (page 34).
An MD is not played from the first track.	<ul style="list-style-type: none"> • Disc playing stopped before it came to the last track. <ul style="list-style-type: none"> ➔ Press ◀◀ repeatedly or open and close the lid once to go back to the beginning of the disc, and restart playing after checking the track number in the display.
Playback sound skips.	<ul style="list-style-type: none"> • The recorder is placed where it receives continuous vibration. <ul style="list-style-type: none"> ➔ Put the recorder on a stable place. • A very short track may cause sound to skip.

Symptom	Cause/Solution
Sound has a lot of static.	<ul style="list-style-type: none"> • Strong magnetism from a television or such device is interfering with operation. ➔ Move the recorder away from the source of strong magnetism.
Cannot find the track marks.	<ul style="list-style-type: none"> • You pressed after pressing ⏮ or ⏭. ➔ Press before or pressing ⏮ or ⏭ (page 45).
The rechargeable battery does not start charging.	<ul style="list-style-type: none"> • The rechargeable battery has been inserted incorrectly or the AC power adaptor has been connected incorrectly. ➔ Insert the battery correctly or connect the AC power adaptor correctly.

System limitations

The recording system in your MiniDisc recorder is radically different from those used in cassette and DAT decks and is characterized by the limitations described below. Note, however, that these limitations are due to the inherent nature of the MD recording system itself and not to mechanical causes.

Symptom	Cause
“TR FULL” appears even before the disc has reached the maximum recording time (60, 74, or 80 minutes).	When 254 tracks have been recorded on the disc, “TR FULL” appears regardless of the total recorded time. More than 254 tracks cannot be recorded on the disc. To continue recording, erase unnecessary tracks.
“TR FULL” appears even before the disc has reached the maximum track number or recording time.	Repeated recording and erasing may cause fragmentation and scattering of data. Although those scattered data can be read, each fragment is counted as a track. In this case, the number of tracks may reach 254 and further recording is not possible. To continue recording, erase unnecessary tracks.
Track marks cannot be erased. The remaining recording time does not increase even after erasing numerous short tracks.	When the data of a track is fragmented, the track mark of a fragment under 12 seconds long cannot be erased. You cannot combine a track recorded in stereo and a track recorded in monaural; nor can you combine a track recorded with digital connection and a track recorded with analog connection. Tracks of under 12 seconds in length are not counted and so erasing them may not lead to an increase in the recording time.

Symptom	Cause
<p>The total recorded time and the remaining time on the disc may not total the maximum recording time (60, 74, or 80 minutes).</p>	<p>Normally, recording is done in minimum units of approximately 2 seconds. When recording is stopped, the last unit of recording always uses this unit of 2 seconds even if the actual recording is shorter. Likewise, when recording is restarted after the stop, the recorder will automatically insert a blank space amounting to 2 seconds before the next recording. (This is to prevent accidental erasing of a previous track whenever a new recording is started). Therefore, the actual recording time will decrease whenever a recording is stopped; a maximum of 6 seconds compared to the potential recording time for each stop.</p>
<p>The edited tracks may exhibit sound dropout during search operations.</p>	<p>The fragmentation of data may cause sound dropout while searching because the tracks are played in higher speed than normal playback.</p>

Messages

If the following error messages flash in the display window, check the chart below.

Error message	Meaning/Remedy
BLANKDISC	<ul style="list-style-type: none">• An MD with no recording on it is inserted. ➔ Insert a recorded MD.
DISC ERR	<ul style="list-style-type: none">• The disc is damaged or does not contain proper recording or editing data. ➔ Reinsert the disc. If this fails, rerecord.
DISC FULL	<ul style="list-style-type: none">• There is no more space to record on the disc (less than 12 seconds available). ➔ Replace the disc.
Data Save	<ul style="list-style-type: none">• The MD player is recording information (sounds) from the memory to the disk. ➔ Wait until this process is completed. Do not expose the player to any physical shock, nor disrupt power supply.
TOC Edit	<ul style="list-style-type: none">• The MD player is recording information (track start and end position) from the memory to the disk. ➔ Wait until this process is completed. Do not expose the player to physical shock, nor disrupt power supply.
BUSY	<ul style="list-style-type: none">• You tried to operate the recorder while it was accessing the recorded data. ➔ Wait until the message goes out (in rare cases, it may take 2–3 minutes).
NAME FULL	<ul style="list-style-type: none">• You tried to enter more than 200 letters to label a single track or disc.• You tried to enter a total of more than 1700 letters for track or disc names during playback or stop. ➔ Enter the characters within the limit.

Error message	Meaning/Remedy
Hi DC in	<ul style="list-style-type: none"> • Voltage of the power supply is too high (The supplied AC power adaptor or the recommended car battery cord is not used). ➔ Use the supplied AC power adaptor or the recommended car battery cord.
HOLD	<ul style="list-style-type: none"> • The recorder is locked. ➔ Slide HOLD against the arrow to unlock the recorder (page 37).
LOW BATT	<ul style="list-style-type: none"> • Batteries are weak. ➔ Charge the rechargeable battery or replace the dry battery (page 53).
MEM OVER	<ul style="list-style-type: none"> • You tried to record with the recorder placed where it receives continuous vibration. ➔ Put the recorder on a stable place, and start recording again.
NO COPY	<ul style="list-style-type: none"> • You tried to make a copy from a disc that is protected by the Serial Copy Management System. You cannot make copies from a digitally connected source which was itself recorded using digital connection. ➔ Use analog connection instead (page 18).
NO DISC	<ul style="list-style-type: none"> • You tried to play or record with no disc in the recorder. ➔ Insert an MD.
NO SIGNAL	<ul style="list-style-type: none"> • The recorder could not detect digital input signals. ➔ Make sure that the source is connected firmly (page 8).
P/B ONLY	<ul style="list-style-type: none"> • You tried to record or edit on a premastered MD (P/B stands for “playback”). ➔ Insert a recordable MD.
PROTECTED	<ul style="list-style-type: none"> • You tried to record or edit on a MD with the tab in the record-protect position. ➔ Slide the tab back (page 58).

Error message	Meaning/Remedy
SORRY	<ul style="list-style-type: none"> • You tried to erase the track mark at the beginning of the first track. • You tried to erase a track mark to combine tracks the recorder cannot combine (a track recorded in stereo and in mono, for example). • You tried to press ■ or T MARK during synchro-recording.
TEMP OVER	<ul style="list-style-type: none"> • Heat has built up in the recorder. ➔ Let the recorder cool down.
TR FULL	<ul style="list-style-type: none"> • There is no more space for new data when you are editing the MD. ➔ Erase unnecessary tracks (page 40).
TrPROTECT	<ul style="list-style-type: none"> • You tried to record or edit on a track that is protected from erasing. ➔ Record or edit on other tracks.
EDITING	<ul style="list-style-type: none"> • You pressed a key on the recorder while editing on the remote control.
MENU	<ul style="list-style-type: none"> • You pressed a key on the remote control while selecting a menu on the recorder.

Specifications

System

Audio playing system

MiniDisc digital audio system

Laser diode properties

Material: GaAlAs

Wavelength: $\lambda = 790$ nm

Emission duration: continuous

Laser output: less than $44.6 \mu\text{W}$

(This output is the value measured at a distance of 200 mm from the lens surface on the optical pick-up block with 7 mm aperture.)

Recording and playback time

Maximum 80 minutes (MDW-80, stereo recording)

Maximum 160 minutes (MDW-80, monaural recording)

Maximum 74 minutes (MDW-74, stereo recording)

Maximum 148 minutes (MDW-74, monaural recording)

Revolutions

400 rpm to 1,800 rpm (CLV)

Error correction

Advanced Cross Interleave Reed Solomon Code (ACIRC)

Sampling frequency

44.1 kHz

Sampling rate converter

Input: 32 kHz/44.1 kHz/48 kHz

Coding

Adaptive Transform Acoustic Coding (ATRAC)

Modulation system

EFM (Eight to Fourteen Modulation)

Number of channels

2 stereo channels

1 monaural channel

Frequency response

20 to 20,000 Hz ± 3 dB

Wow and Flutter

Below measurable limit

Inputs

Microphone: stereo mini-jack, 0.35–1.38 mV

Line in: stereo mini-jack, 69–194 mV

Optical (Digital) in: optical (digital) mini-jack

Outputs

①: stereo mini-jack, maximum output level 5 mW + 5 mW, load impedance 16 ohm

②: stereo mini-jack, maximum output level 5 mW + 5 mW, load impedance 16 ohm

General

Power requirements

Sony AC Power Adaptor (supplied) connected at the DC IN 3 V jack:

120 V AC, 60 Hz (US model)

230–240 V AC, 50/60 Hz (UK and Hong Kong model)

240 V AC, 50/60 Hz (Australia and New Zealand model)

220–230 V AC, 50/60 Hz (European model)

220 V AC, 50 Hz (China model)

220 V AC, 50 Hz (Argentina model)

100–240 V AC, 50/60 Hz (Other models)

Nickel cadmium rechargeable battery NC-WMAA (supplied)

LR6 (size AA) alkaline battery (not supplied)

Battery operation time

See "Battery life" (page 55)

Dimensions

Approx. 81 × 74 × 26.2 mm (w/h/d)
(3¹/₄ × 3 × 1¹/₁₆ in.) without
projections.

Mass

Approx. 115 g (4 oz) the recorder
only

Approx. 155 g (5.4 oz) incl. a
recordable MD, and NC-WMAA
nickel cadmium rechargeable battery

Supplied accessories

AC power adaptor (1)

Headphones with a remote control
(1)

Optical cable (1)

NC-WMAA nickel cadmium
rechargeable battery (1)

Rechargeable battery carrying case
(1)

Carrying pouch (1)

Optional accessories

Optical Cable

POC-15B, POC-15AB, POC-
DA12SP

Line Cable RK-G129, RK-G136

Stereo Microphones ECM-717,
ECM-MS907, ECM-MS957

Stereo Headphones* MDR-D77,
MDR-D55

Active Speakers SRS-Z500

Recordable MDs MDW-series

Your dealer may not handle some of
the above listed accessories. Please
ask the dealer for detailed
information about the accessories in
your country.

US and foreign patents licensed
from Dolby Laboratories Licensing
Corporation.

Design and specifications are subject
to change without notice.

- * Whether you should plug the
headphones directly to Ⓜ1 (or
Ⓜ2) jack on the main unit or to a
remote control, use only
headphones with stereo mini
plugs.

stereo mini plugs

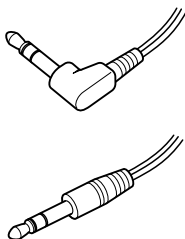

What is an MD?

How MiniDisc works

MiniDisc (MD) comes in two types: premastered (prerecorded) and recordable (blank).

Premastered MDs, recorded at music studios, can be played back almost endlessly. However, they can't be recorded on or over like cassette tapes. To record, you must use a "recordable MD".

Premastered MDs

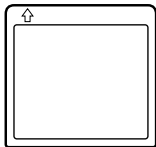

Premastered MDs are recorded and played like regular CDs. A laser beam focuses on the pits in the surface of the MD and reflects the information back to the lens in the recorder. The recorder then decodes the signals and plays them back as music.

How the MiniDisc got so small

The 2.5-inch MiniDisc, encased in a plastic cartridge that looks like a 3.5-inch diskette (see illustration above), uses a new digital audio compression technology called ATRAC (Adaptive TRAnsform Acoustic Coding). To store more sound in less space, ATRAC

Recordable MDs

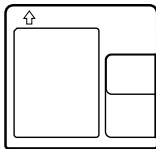

Recordable MDs, which use magneto-optical (MO) technology, can be recorded again and again. The laser inside the recorder applies heat to the MD, demagnetizing the magnetic layer of the MD. The recorder then applies a magnetic field to the layer. This magnetic field corresponds exactly to the audio signals generated by the connected source. (The north and south polarities equate to digital "1" and "0".) The demagnetized MD adopts the polarity of the magnetic field, resulting in a recorded MD.

Quick Random Access

Like CDs, MDs offer instantaneous random access to the beginning of any music track. Premastered MDs are recorded with location addresses corresponding to each music selection.

Recordable MDs are manufactured with a “User TOC Area” to contain the order of the music. The TOC (Table of Contents) system is similar to the

“directory management system” of floppy disks. In other words, starting and ending addresses for all music tracks recorded on the disc are stored in this area. This lets you randomly access the beginning of any track as soon as you enter the track number (AMS), as well as label the location with a track name as you would a file on a diskette.

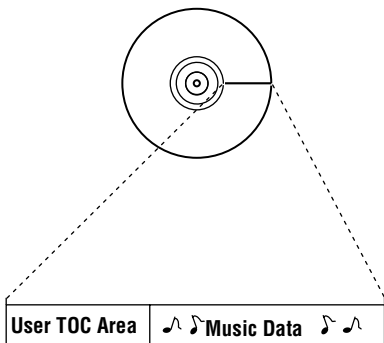

Contains the order and start/end points of the music.

Shock-Resistant Memory

One major drawback of optical read systems is that they can skip or mute when subjected to vibration. The MD system resolves this problem by using a buffer memory that stores audio data.

Looking at the controls

See pages in () for more details.

The recorder

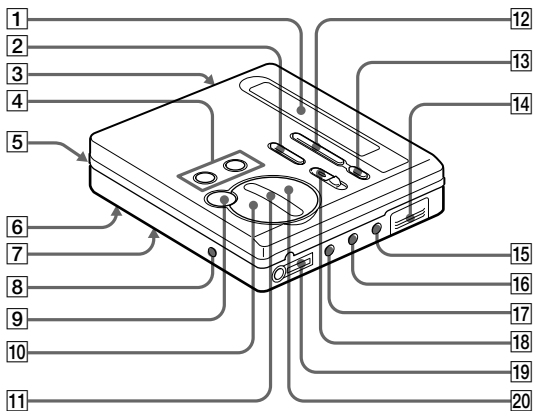

- 1 Display window (19)(31)
- 2 END SEARCH button (10)(49)
- 3 OPEN button (9)(13)
- 4 VOL +/- button (13)(49)
- 5 T MARK button (41)
- 6 HOLD switch (37)
- 7 SYNCHRO REC (synchro-recording) switch (19)
- 8 DC IN 3V jack (8)(12)(53)
- 9 ■ (pause) button (10)(14)(22)(49)

- 10 ■ (stop) button (9)(14)(41)(54)
- 11 ◀▶/▶▶ (search /AMS) button (10)(14)(45)(49)
- 12 ◀—MENU—▶ button (22)(30)(41)
- 13 ENTER button (22)(30)(40)
- 14 Battery compartment (54)
- 15 MIC (PLUG IN POWER) jack (21)
- 16 LINE IN (OPTICAL) jack (8)(18)

- 17 (headphones)2 jack
(12)(38)
- 18 REC (record) switch (9)

- 19 (headphones)1 jack
(12)(38)
- 20 (play) button (10)(13)

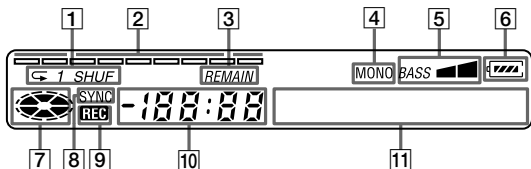

The display window

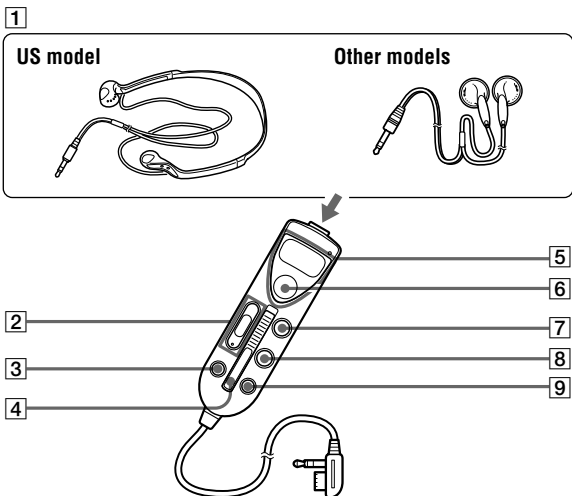

- 1 Play mode indication (31)
Shows the play mode of the MD.
- 2 Level meter (24)
Shows the volume of the MD being played or recorded.
- 3 REMAIN (remaining time/ tracks) indication (25)(35)
Lights up along with the remaining time of the track, the remaining time of the MD, or the remaining number of tracks.
- 4 MONO (monaural) indication
- 5 Mega bass indication (32).
- 6 Battery indication (54)
Shows approximate battery condition.
- 7 Disc indication
Shows that the disc is rotating for recording, playing or editing an MD
- 8 SYNC (synchro-recording) indication
- 9 REC indication (9)
Lights up while recording. When flashing, the recorder is in record standby mode.
- 10 Time display
- 11 Character information display (26)(31)
Displays the disc and track names, error messages, track numbers, etc.

The headphones with a remote control



- 1** Headphones
Can be replaced with optional headphones.
- 2** VOL +/--buttons (13)(51)
- 3** DELETE button (51)
- 4** HOLD switch (37)
Slide to lock the controls of the remote control.
- 5**  button
(13)(28)(31)(41)(51)
- 6**  (stop) • ENTER button
(14)(47)(50)
- 7**  (pause) • CAPS button
(14)(51)
- 8** T MARK button
(41)(45)(51)
- 9** EDIT button (28)(33)(41)

Sony  line <http://www.world.sony.com/>

Printed on recycled paper

Sony Corporation Printed in Japan
