

# ***Home Theatre System***

---

Operating Instructions

***HT-DDW790***

## WARNING

**To reduce the risk of fire or electric shock, do not expose this apparatus to rain or moisture.**

To prevent fire, do not cover the ventilation of the apparatus with newspapers, table-cloths, curtains, etc. And don't place lighted candles on the apparatus.

To prevent fire or shock hazard, do not place objects filled with liquids, such as vases, on the apparatus.

Do not install the appliance in a confined space, such as a bookcase or built-in cabinet.

Install this system so that the power cord can be unplugged from the wall socket immediately in the event of trouble.



Don't throw away batteries with general house waste; dispose of them correctly as chemical waste.

## For customers in Europe

**Disposal of Old Electrical & Electronic Equipment (Applicable in the European Union and other European countries with separate collection systems)**



This symbol on the product or on its packaging indicates that this product shall not be treated as household waste. Instead it shall be handed over to the applicable collection point for the recycling of electrical and electronic equipment. By ensuring this product is disposed of correctly, you will help prevent potential negative consequences for the environment and human health, which could otherwise be caused by inappropriate waste handling of this product. The recycling of materials will help to conserve natural resources. For more detailed information about recycling of this product, please contact your local Civic Office, your household waste disposal service or the shop where you purchased the product.

## About This Manual

- The instructions in this manual are for model HT-DDW790. In this manual, models of area code CEL is used for illustration purposes unless stated otherwise. Any difference in operation is clearly indicated in the text, for example, “Models of area code SP only”.
- The instructions in this manual describe the controls on the supplied remote. You can also use the controls on the receiver if they have the same or similar names as those on the remote.

### The HT-DDW790 consists of:

- Receiver STR-K790
- Speaker system
  - Front speakers SS-MSP700
  - Center speaker SS-CNP700
  - Surround speakers SS-SRP700
  - Sub woofer SS-WP700

### About area codes

The area code of the receiver you purchased is shown on the lower right portion of the rear panel (see the illustration below).

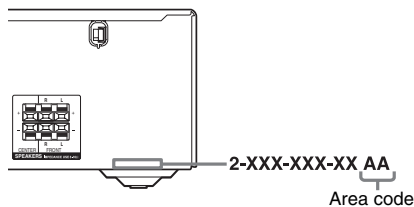

Any differences in operation, according to the area code, are clearly indicated in the text, for example, “Models of area code AA only”.

This receiver incorporates Dolby\* Digital and Pro Logic Surround and the DTS\*\* Digital Surround System.

\* Manufactured under license from Dolby Laboratories.

“Dolby”, “Pro Logic” and the double-D symbol are trademarks of Dolby Laboratories.

\*\* “DTS” and “DTS Digital Surround” are registered trademarks of DTS, Inc.

## Note for the supplied remote

### (RM-AAU013)

The VIDEO 3 button on the remote is not available for receiver operation.

---

# Table of Contents

---

## Getting Started

Description and location of parts.....	5
1: Installing speakers .....	12
2: Connecting speakers.....	14
3: Connecting the audio/video components.....	15
4: Connecting the antennas.....	22
5: Preparing the receiver and the remote .....	23
6: Calibrating the appropriate settings automatically (AUTO CALIBRATION).....	24
7: Adjusting the speaker levels and balance (TEST TONE).....	27

---

## Playback

Selecting a component.....	29
Listening/Watching a component .....	30

---

## Amplifier Operations

Navigating through menus.....	32
Adjusting the level (LEVEL menu).....	35
Adjusting the tone (TONE menu).....	36
Settings for the surround sound (SUR menu).....	36
Settings for the tuner (TUNER menu).....	37
Settings for the audio (AUDIO menu).....	37
Settings for the system (SYSTEM menu).....	38
Calibrating the appropriate settings automatically (A. CAL menu).....	40

---

## Enjoying Surround Sound

Enjoying Dolby Digital and DTS Surround sound (AUTO FORMAT DIRECT) .....	41
Selecting a pre-programmed sound field ....	43
Using only the front speakers and sub woofer (2CH STEREO) .....	46
Resetting sound fields to the initial settings.....	46

---

## Tuner Operations

Listening to FM/AM radio.....	47
Presetting radio stations .....	49
Using the Radio Data System (RDS).....	51
(Models of area code CEL, CEK only)	

---

## Other Operation

Naming inputs.....	53
Changing the display .....	53
Using the Sleep Timer .....	54

---

## Using the Remote

Changing button assignments .....	54
-----------------------------------	----

---

## Additional Information

Glossary .....	55
Precautions.....	56
Troubleshooting .....	58
Specifications.....	61
Index .....	Back cover

## Description and location of parts

### Receiver

#### Front panel

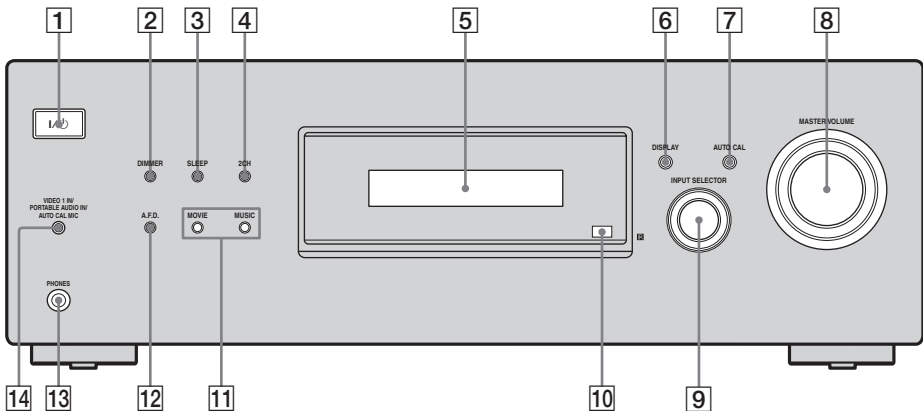

Name	Function
1 I/O (on/standby)	Press to turn the receiver on or off (page 23, 30, 31).
2 DIMMER	Press to adjust the brightness of the display.
3 SLEEP	Press to activate the Sleep Timer function and the duration which the receiver turns off automatically (page 54).
4 2CH	Press to select 2CH STEREO mode (page 46).
5 Display	The current status of the selected component or a list of selectable items appears here (page 6).
6 DISPLAY	Press to select information displayed on the display (page 52, 60).
7 AUTO CAL	Press to activate the Auto Calibration function (page 25).

Name	Function
8 MASTER VOLUME	Turn to adjust the volume level of all speakers at the same time (page 28, 29, 30, 31).
9 INPUT SELECTOR	Turn to select the input source to playback (page 29, 31, 53).
10 Remote sensor	Receives signals from remote commander.
11 MOVIE, MUSIC	Press to select sound fields (MOVIE, MUSIC) (page 43).
12 A.F.D.	Press to select A.F.D. mode (page 41).
13 PHONES jack	Connects to a headphone (page 58).
14 VIDEO 1 IN/ PORTABLE AUDIO IN/ AUTO CAL MIC jack	<ul style="list-style-type: none"> <li>Connects to the supplied optimizer microphone for the Auto Calibration function (page 24).</li> <li>Connects to a portable audio such as MP3 player, etc. (page 16).</li> </ul>

## About the indicators on the display

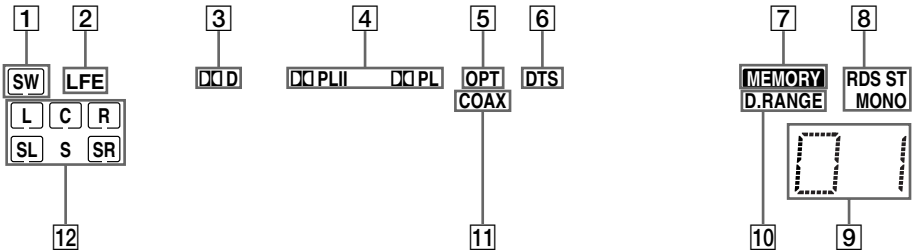

Name	Function
<b>1 SW</b>	Lights up when audio signal is output from the SUB WOOFER jack.
<b>2 LFE</b>	Lights up when the disc being played back contains an LFE (Low Frequency Effect) channel and the LFE channel signal is actually being reproduced.
<b>3 DDD</b>	Lights up when the receiver is decoding Dolby Digital signals. <b>Note</b> When playing a Dolby Digital format disc, be sure that you have made digital connections.
<b>4 PL/PLII</b>	“ <b>PL</b> ” lights up when the receiver applies Pro Logic processing to 2 channel signals in order to output the center and surround channel signals. “ <b>PLII</b> ” lights up when the Pro Logic II Movie/Music decoder is activated.
<b>5 OPT</b>	Lights up when VIDEO 2 input is selected. However, “UNLOCK” appears on the display if no digital signal is input through the OPTICAL jack.
<b>6 DTS</b>	Lights up when the receiver is decoding DTS signals. <b>Note</b> When playing a DTS format disc, be sure that you have made digital connections.
<b>7 MEMORY</b>	Lights up when a memory function, such as Name Input, Preset Memory (page 49), etc., is activated.
<b>8 Tuner Indicators</b>	Lights up when using the receiver to tune in radio stations (page 47), etc. <b>Note</b> “RDS” appears for models of area code CEL, CEK only.
<b>9 Preset station indicators</b>	Lights up when using the receiver to tune in radio stations you have preset. For details on presetting radio stations, see page 49.
<b>10 D.RANGE</b>	Lights up when dynamic range compression is activated (page 35).
<b>11 COAX</b>	Lights up when DVD input is selected. However, “UNLOCK” appears on the display if no digital signal is input through the COAXIAL jack.

Name	Function
12 <b>Playback channel indicators</b>	The letters (L, C, R, etc.) indicate the channels being played back. The boxes around the letters vary to show how the receiver downmixes the source sound.
L	Front Left
R	Front Right
C	Center (monaural)
SL	Surround Left
SR	Surround Right
S	Surround (monaural or the surround components obtained by Pro Logic processing)
	<b>Example:</b> Recording format (Front/Surround): 3/2.1 Sound Field: A.F.D. AUTO
	<div style="text-align: center;"> <span style="border: 1px solid black; padding: 2px;">SW</span> LFE         </div> <div style="text-align: center; margin-top: 5px;"> <span style="border: 1px solid black; padding: 2px;">L</span> <span style="border: 1px solid black; padding: 2px;">C</span> <span style="border: 1px solid black; padding: 2px;">R</span> </div> <div style="text-align: center; margin-top: 5px;"> <span style="border: 1px solid black; padding: 2px;">SL</span> <span style="border: 1px solid black; padding: 2px;">SR</span> </div>

# Rear panel

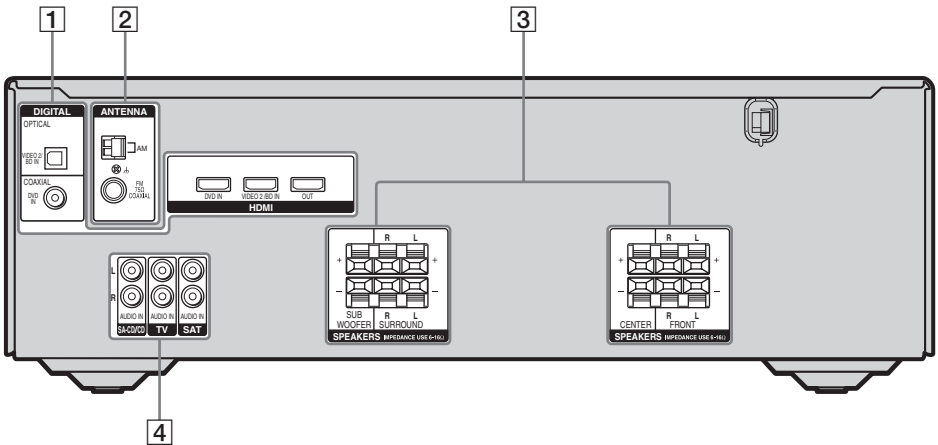

## 1 DIGITAL INPUT section



**OPTICAL IN jack** Connects to a DVD player, etc. The COAXIAL jack provides a better quality of loud sound (page 20).



**COAXIAL IN jack**



**HDMI IN/OUT jacks\*** Connects to a DVD player, etc. The image and the sound are output to a TV or a projector (page 18).

## 2 ANTENNA section



**FM ANTENNA jack** Connects to the FM wire antenna supplied with this receiver (page 22).



**AM ANTENNA terminals** Connects to the AM loop antenna supplied with this receiver (page 22).

## 3 SPEAKERS section



Connects to the speakers and sub woofer (page 14).

## 4 AUDIO INPUT section



**White (L) AUDIO IN jacks** Connects to a CD player, etc. (page 16).



**Red (R)**

\* You can watch the selected input image when you connect the HDMI OUT jack to a TV or projector (page 18).



## Remote commander

You can use the supplied remote RM-AAU013 to operate the receiver and to control the Sony audio/video components that the remote is assigned to operate (page 54).

### RM-AAU013

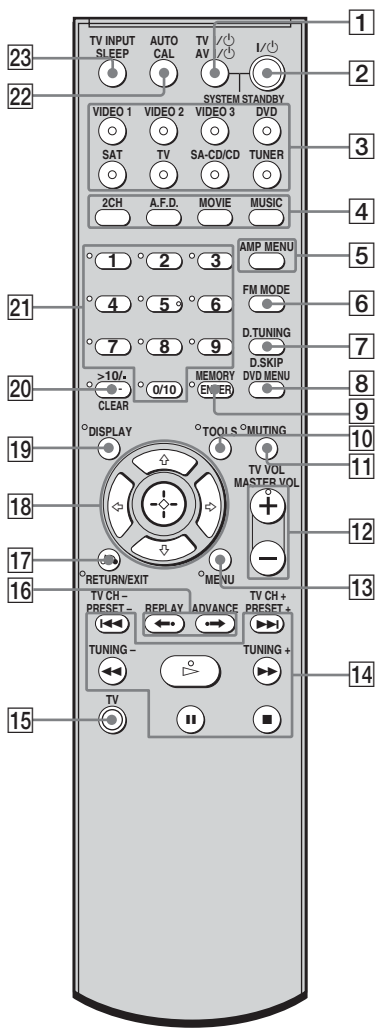

Name	Function
------	----------

**1 TV I/⏻ (on/standby)** Press TV I/⏻ and TV (15) at the same time to turn the TV on or off.

**AV I/⏻ (on/standby)** Press to turn on or off the Sony audio/video components that the remote is assigned to operate. If you press I/⏻ (2) at the same time, it will turn off the receiver and other components (SYSTEM STANDBY).

**Note**  
The function of the AV I/⏻ switch changes automatically each time you press the input buttons (3).











**2 I/⏻ (on/standby)** Press to turn the receiver on or off. To turn off all components, press I/⏻ and AV I/⏻ (1) at the same time (SYSTEM STANDBY).

**3 Input buttons** Press one of the buttons to select the component you want to use. When you press any of the input buttons, the receiver turns on. The buttons are factory assigned to control Sony components as follows. You can change the button assignments following the steps in “Changing button assignments” on page 54.

Button	Assigned Sony component
VIDEO 1	VCR (VTR mode 3)
VIDEO 2	VCR (VTR mode 2)
VIDEO 3	Not assigned
DVD	DVD player
SAT	Satellite tuner
TV	Television
SA-CD/CD	Super Audio CD/CD player
TUNER	Built-in tuner

Name	Function
<b>4 2CH</b>	Press to select 2CH STEREO mode.
<b>A.F.D.</b>	Press to select A.F.D. mode.
<b>MOVIE, MUSIC</b>	Press to select sound fields (MOVIE, MUSIC).
<b>5 AMP MENU</b>	Press to display the menu of the receiver. Then, use $\uparrow$ , $\downarrow$ , $\leftarrow$ , $\rightarrow$ and $\odot$ to perform menu operations.
<b>6 FM MODE</b>	Press to select FM monaural or stereo reception.
<b>7 D.TUNING</b>	Press to enter direct tuning mode.
<b>D.SKIP</b>	Press to skip disc of the CD player or DVD player (multi-disc changer only).
<b>8 DVD MENU</b>	Press to display the menu of the DVD player on the TV screen. Then, use $\uparrow$ , $\downarrow$ , $\leftarrow$ , $\rightarrow$ and $\odot$ to perform menu operations.
<b>9 ENTER</b>	Press to enter the value after selecting a channel, disc or track using the numeric buttons of the TV, VCR or satellite tuner.
<b>MEMORY</b>	Press to store a station.
<b>10 TOOLS</b>	Press to display options applicable to the entire disc (e.g. disc protection), recorder (e.g. audio settings during recording), or multiple items on a list menu (e.g. erasing multiple titles). Press TOOLS and TV (15) at the same time to display options applicable to the TV.
<b>11 MUTING</b>	Press to activate the muting function. Press MUTING and TV (15) at the same time to activate the TV's muting function.
<b>12 TV VOL +*/-</b>	Press TV VOL +/- and TV (15) at the same time to adjust the TV volume level.
<b>MASTER VOL +*/-</b>	Press to adjust the volume level of all speakers at the same time.

Name	Function
<b>13 MENU</b>	Press to display the menus of the VCR, DVD player, Blu-ray disc player or satellite tuner on the TV screen. Press MENU and TV (15) at the same time to display the TV's menu. Then, use $\uparrow$ , $\downarrow$ , $\leftarrow$ , $\rightarrow$ and $\odot$ to perform menu operations.
<b>14 <math>\lll/\ggg</math></b>	Press to skips tracks of the CD player, DVD player or Blu-ray disc player.
<b><math>\lll/\ggg</math></b>	Press to search tracks in the forward/backward direction of the DVD player or to fast forward/rewind of the VCR, CD player or Blu-ray disc player.
<b><math>\triangleright^*</math></b>	Press to start playback of the VCR, CD player, DVD player or Blu-ray disc player.
<b>II</b>	Press to pause playback or recording of the VCR, CD player, DVD player or Blu-ray disc player. (Also starts recording with components in recording standby.)
<b>■</b>	Press to stop playback of the VCR, CD player, DVD player or Blu-ray disc player.
<b>TV CH +/-</b>	Press TV CH +/- and TV (15) at the same time to select preset TV channels.
<b>PRESET +/-</b>	Press to select preset stations or preset channels of the VCR or satellite tuner.
<b>TUNING +/-</b>	Press to scan a station.
<b>15 TV</b>	Press TV and the button you want at the same time to activate the buttons with orange printing.
<b>16 REPLAY <math>\leftarrow</math>/ ADVANCE <math>\rightarrow</math></b>	Press to replay the previous scene or fast forward the current scene of the VCR, Blu-ray disc player or DVD player.

Name	Function
<b>17</b> RETURN/ EXIT 	Press to return to the previous menu or exit the menu while the menu or on-screen guide of the VCR, DVD player, or satellite tuner is displayed on the TV screen. Press RETURN/EXIT  and TV (15) at the same time to return to the previous menu or exit the TV's menu while the menu is displayed on the TV screen.
<b>18</b>  	After pressing AMP MENU (5), DVD MENU (8), or MENU (13), press  ,  ,  , or  to select the settings. Then, press  to enter the selection for DVD MENU or MENU. Press  also to enter the selection of the receiver, VCR, satellite tuner, CD player, Blu-ray disc player or DVD player.
<b>19</b> DISPLAY	Press to select the information displayed on the TV screen of the VCR, satellite tuner, CD player, Blu-ray disc player or DVD player. Press DISPLAY and TV (15) at the same time to select TV information displayed on the TV screen.
<b>20</b> -/--	Press -/-- and TV (15) at the same time to select the channel entry mode, either one or two digits of the TV.
>10/-	Press to select track numbers over 10 of the VCR, satellite tuner or CD player or to select channel numbers of the Digital CATV terminal.
CLEAR	Press to clear a mistake when you press the incorrect numeric buttons.

Name	Function
<b>21</b> Numeric buttons (number 5*)	Press to preset/tune to preset stations or to select track numbers of the CD player, Blu-ray disc player or DVD player or to select channel numbers of the VCR or satellite tuner. Press 0/10 to select track number 10. Press the numeric buttons and TV (15) at the same time to select the TV channels.
<b>22</b> AUTO CAL	Press to activate the Auto Calibration function.
<b>23</b> TV INPUT	Press TV INPUT and TV (15) at the same time to select the input signal (TV input or video input).
SLEEP	Press to activate the Sleep Timer function and the duration which the receiver turns off automatically.

\* The number 5, MASTER VOL +, TV VOL +, and  buttons have tactile dots. Use the tactile dots as references when operating the receiver.

### Notes

- Some functions explained in this section may not work depending on the model.
- The above explanation is intended to serve as an example only. Therefore, depending on the component, the above operation may not be possible or may operate differently than described.
- The VIDEO 3 button on the remote is not available for receiver operation.

# 1: Installing speakers

To fully enjoy theater-like multi channel surround sound requires five speakers (two front speakers, a center speaker, and two surround speakers) and a sub woofer (5.1 channel).

## Example of 5.1 channel speaker system configuration

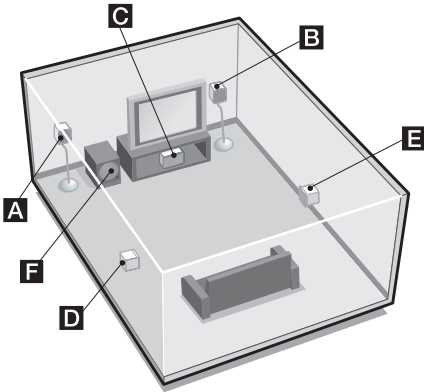

- A** Front speaker (Left)
- B** Front speaker (Right)
- C** Center speaker
- D** Surround speaker (Left)
- E** Surround speaker (Right)
- F** Sub woofer

### Tip

Since the sub woofer does not emit highly directional signals, you can place it wherever you want.

## Installing the speakers on a flat surface

Before you install the speakers and sub woofer, be sure to attach the supplied foot pads to prevent vibration or movement as shown in the illustration below.

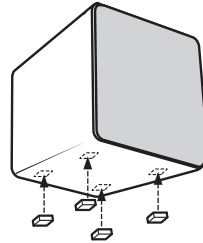

## Installing the speakers on the speaker stand

For greater flexibility in positioning the speakers, use the optional WS-FV11 or WS-FV10D speaker stand (available only in certain countries). Be sure to detach the screw from the speaker and use it when you install the speaker to the speaker stand. For details, refer to the operating instructions supplied with the speaker stand.

## Installing the speakers on the wall

You can install your front and surround speakers on the wall.

- 1 Prepare screws (not supplied) that are suitable for the hook on the back of each speaker as shown in the illustrations below.**

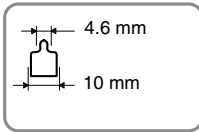
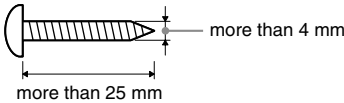

Hook on the back of the speaker

- 2 Fasten the screws to the wall. The screws should protrude to 5 to 7 mm.**

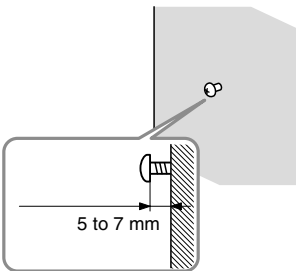

- 3 Hang the speakers on the screws.**

Hook on the back of the speaker

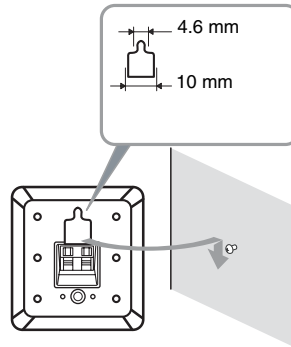

### Notes

- Use screws that are suitable for the wall material and strength. As a plaster board wall is especially fragile, attach the screws securely to a beam and fasten them to the wall. Install the speakers on a vertical and flat wall where reinforcement is applied.
- Contact a screw shop or installer regarding the wall material or screws to be used.
- Sony is not responsible for accident or damage caused by improper installation, insufficient wall strength or improper screw installation, natural calamity, etc.

## 2: Connecting speakers

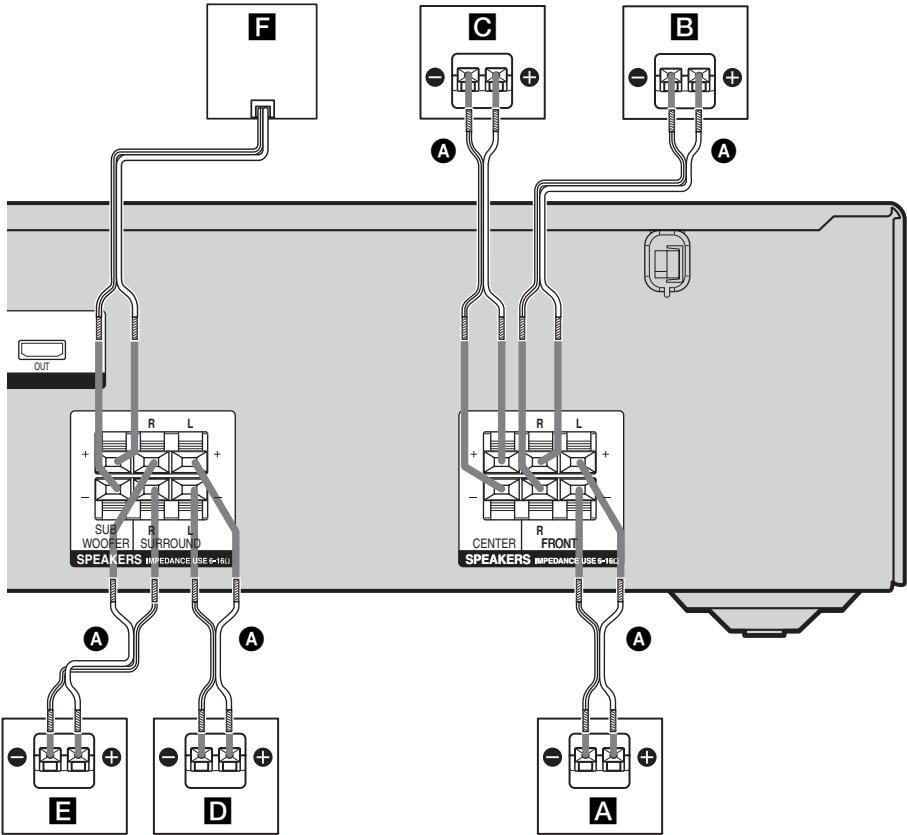

**A** Speaker cord (supplied)<sup>a)</sup>

**A** Front speaker (Left)

**B** Front speaker (Right)

**C** Center speaker

**D** Surround speaker (Left)

**E** Surround speaker (Right)

**F** Sub woofer

### Tip

Use the supplied speakers to optimize the system's performance.

<sup>a)</sup> Use the long speaker cords to connect the surround speakers and the short speaker cords to connect the front and center speakers.

### To connect the speakers correctly

Check the speaker type by referring to the speaker label\* on the speaker.

Character on speaker label	Speaker type	Location of speaker label
L	Front left	Bottom
R	Front right	Bottom
SL	Surround left	Bottom
SR	Surround right	Bottom

\* The center speaker and sub woofer does not have the character on the speaker label. For details on the speaker type, see page 3.

## 3: Connecting the audio/video components

### How to connect your components

This section describes how to hook up your components to this receiver. Before you begin, refer to “Component to be connected” below for the pages which describe how to connect the audio/video components.

After connect all your components, proceed to “4: Connecting the antennas” (page 22).

### Component to be connected

To connect	See
Audio components	page 16
<ul style="list-style-type: none"> <li>• Super Audio CD player/ CD player</li> <li>• Portable audio such as MP3 player, etc.</li> </ul>	
With HDMI jack	page 18
<ul style="list-style-type: none"> <li>• DVD player</li> <li>• Blu-ray disc player</li> <li>• TV, projector, etc.</li> </ul>	
Video components	page 20
<ul style="list-style-type: none"> <li>• DVD player</li> <li>• Satellite tuner/Set-top box</li> <li>• Blu-ray disc player</li> <li>• Television</li> </ul>	

## Connecting audio components

The following illustration shows how to connect audio components such as MP3 player, Super Audio CD player or CD player.

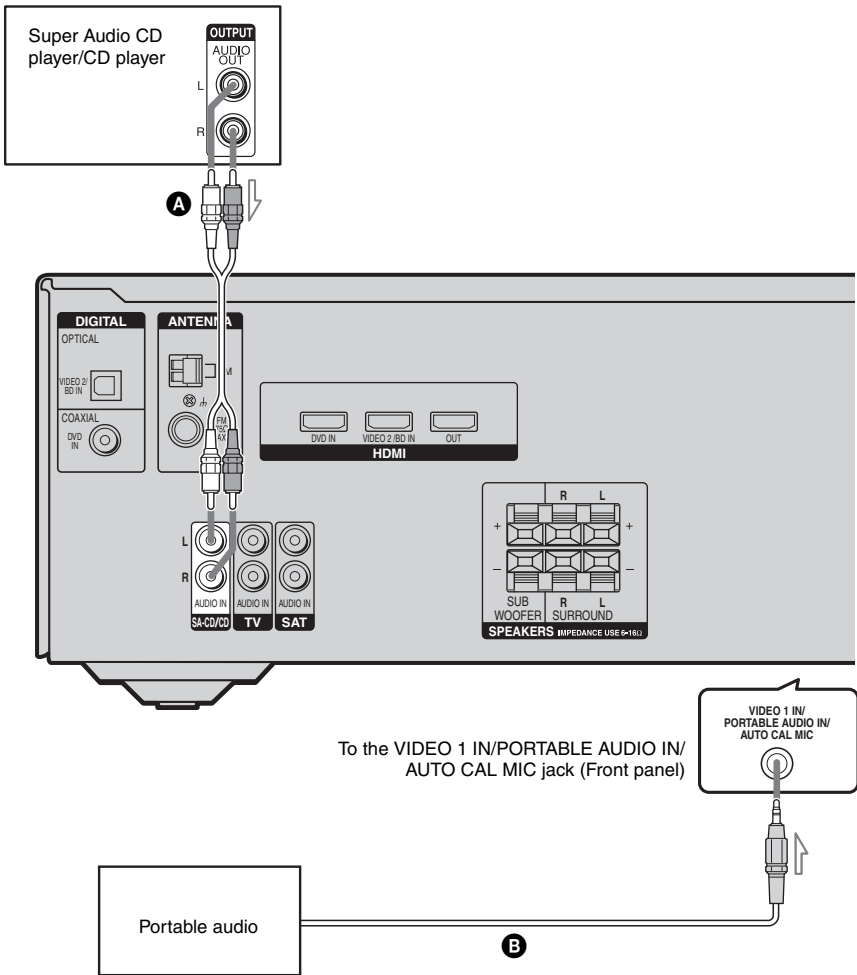

**A** Audio cord (not supplied)

**B** RCA cable with stereo headphone jack (not supplied)



## Notes

- When listening to a component connected to the VIDEO 1 IN/PORTABLE AUDIO IN/AUTO CAL MIC jack on the front panel of this receiver, sound may be distorted or interrupted. This is not a malfunction and will depend on the connected component.
- If the sound from the component connected to the VIDEO 1 IN/PORTABLE AUDIO IN/AUTO CAL MIC jack is very soft, you may increase the volume level. However, before you select other component, be sure to reduce the volume level to avoid damaging your speaker.

## Tip

You are recommended to use “PORTABLE” sound field if the source is MP3 or other compressed source.

## Connecting components with HDMI jacks

HDMI is the abbreviated name for High-Definition Multimedia Interface. It is an interface which transmits video and audio signals in digital format.

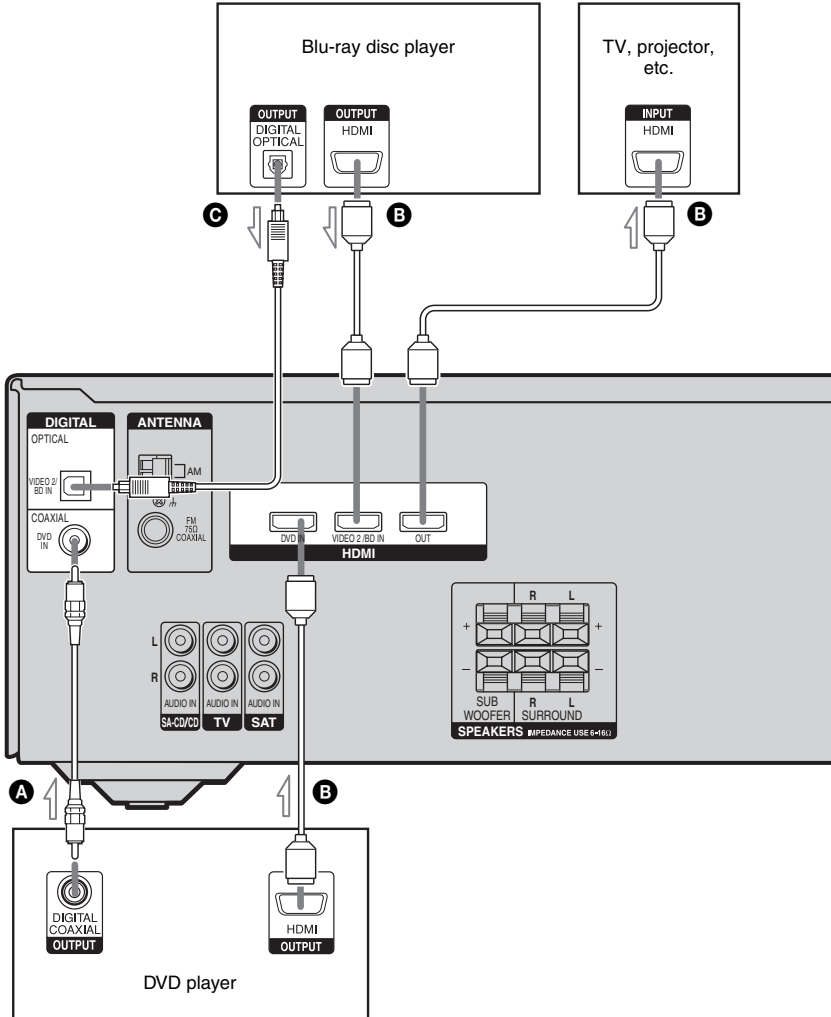

- A** Coaxial digital cord (supplied)
- B** HDMI cable (not supplied)  
We recommend that you use a Sony HDMI cable.
- C** Optical digital cord (not supplied)

## Notes on HDMI connections

- The sound is output from the TV speaker only when a playback component and this receiver, as well as this receiver and the TV are connected via the HDMI jack. To output the sound from the supplied speakers and to take advantage of the multi channel surround sound, be sure to
  - connect the digital audio jacks on the playback component to the receiver.
  - turn off or mute the TV's volume.
- The multi/stereo area audio signals of a Super Audio CD are not output.
- Video signals input to the HDMI IN jack can only be output from the HDMI OUT jack.
- Check the setup of the connected component if an image is poor or the sound does not come out of a component connected via the HDMI cable.
- This receiver may not be able to transfer video or audio signals with certain types of components.
- Refer to the operating instructions of each component connected for details.

### Notes

- Be sure to turn on the receiver when the video and audio signals of a playback component are being output to a TV via the receiver. Unless the power is turned on, neither video nor audio signals will be transmitted.
- When connecting optical digital cords, insert the plugs straight in until they click into place.
- Do not bend or tie optical digital cords.
- Be sure to change the factory setting of the VIDEO 2 input button on the remote so that you can use the button to control your blu-ray disc player. For details, see “Changing button assignments” (page 54).
- You can also rename the VIDEO 2 input so that it can be displayed on the receiver's display. For details, see “Naming inputs” (page 53).

### Tip

All the digital audio jacks are compatible with 32 kHz, 44.1 kHz, 48 kHz, and 96 kHz sampling frequencies.

## Connecting video components

The following illustration shows how to connect video components such as DVD player, satellite tuner or blu-ray disc player.

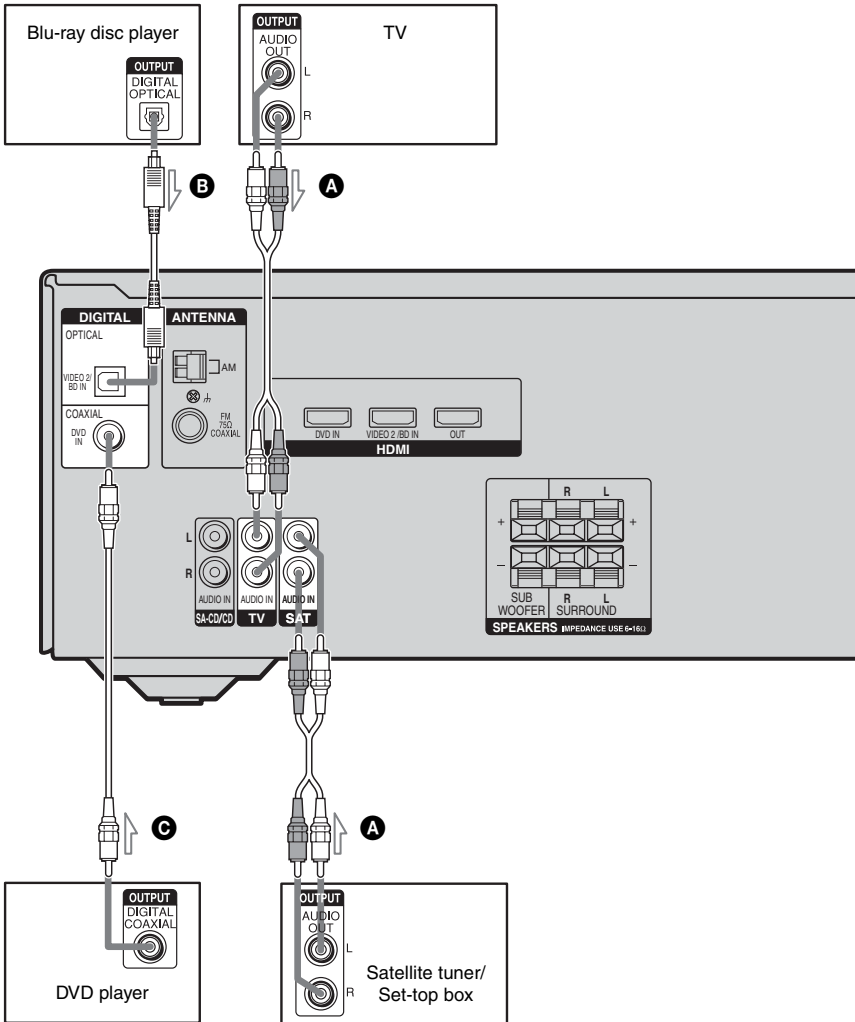

- A** Audio cord (not supplied)
- B** Optical digital cord (not supplied)
- C** Coaxial digital cord (supplied)

## Notes

- To input multi channel digital audio from the DVD player, set the digital audio output setting on the DVD player. Refer to the operating instructions supplied with the DVD player.
- As this receiver does not have analog audio input jacks for DVD, connect your DVD player to the DIGITAL COAXIAL DVD IN jack on the receiver. To output sound from front left/right speakers only, press 2CH.
- When connecting optical digital cords, insert the plugs straight in until they click into place.
- Do not bend or tie optical digital cords.
- Be sure to connect the video output of the DVD player and satellite tuner/set-top box to the TV, so that the image is displayed on the TV. Refer to the operating instructions of each component connected for details.

## Tips

- All the digital audio jacks are compatible with 32 kHz, 44.1 kHz, 48 kHz, and 96 kHz sampling frequencies.
- To output the sound of the TV from the speakers connected to the receiver, be sure to:
  - connect the audio output jacks of the TV to the TV AUDIO IN jacks of the receiver.
  - turn off or mute the TV's volume.

# 4: Connecting the antennas

Connect the supplied AM loop antenna and FM wire antenna.

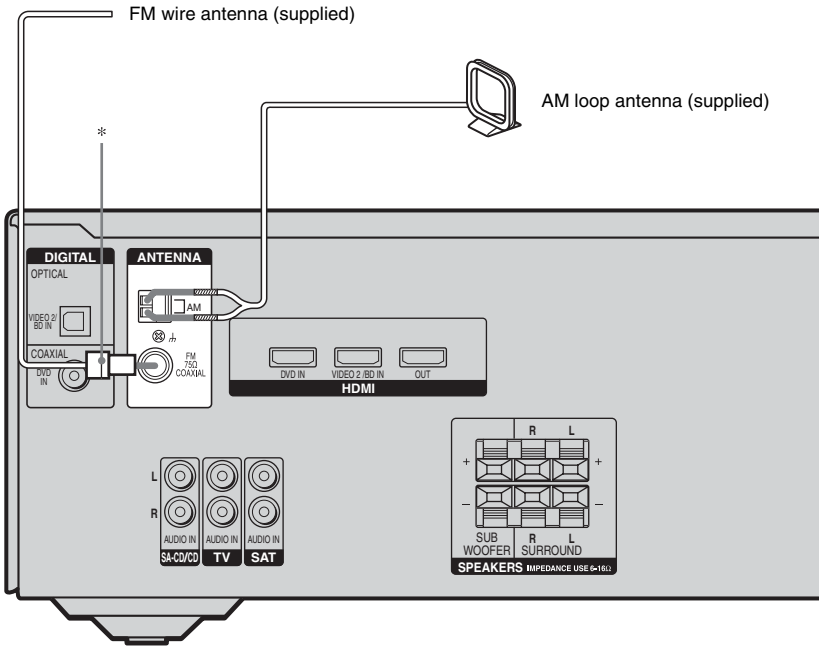

\* The shape of the connector varies depending on the area code of this receiver.

## Notes

- To prevent noise pickup, keep the AM loop antenna away from the receiver and other components.
- Be sure to fully extend the FM wire antenna.
- After connecting the FM wire antenna, keep it as horizontal as possible.

## 5: Preparing the receiver and the remote

### Connecting the AC power cord

Connect the AC power cord to a wall outlet.

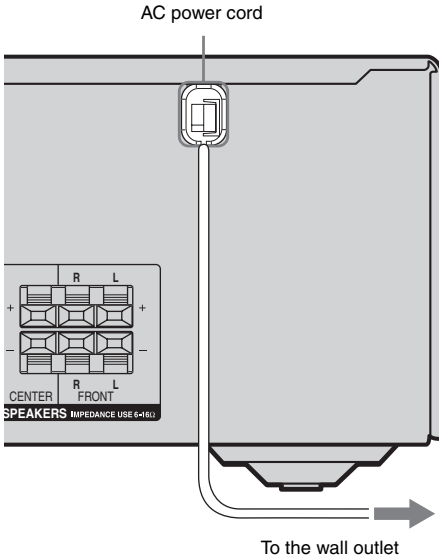

### Performing initial setup operations

Before using the receiver for the first time, initialize the receiver by performing the following procedure. This procedure can also be used to return settings you have made to their factory defaults.

Be sure to use the buttons on the receiver for this operation.

## 1,2

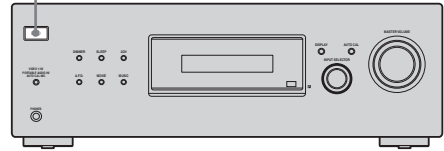

**1** Press I/⏻ to turn off the receiver.

**2** Hold down I/⏻ for 5 seconds.

After “CLEARING” appears on the display for a while, “CLEARED” appears.

The following items are reset to their factory settings.

- All settings in the LEVEL, TONE, SUR, TUNER, AUDIO and SYSTEM menus.
- The sound field memorized for each input and preset station.
- All sound field parameters.
- All preset stations.
- All index names for inputs and preset stations.
- MASTER VOLUME is set to “VOL MIN”.
- Input is set to “DVD”.

## Inserting batteries into the remote

Insert two R6 (size-AA) batteries in the RM-AAU013 remote commander. Observe the correct polarity when installing batteries.

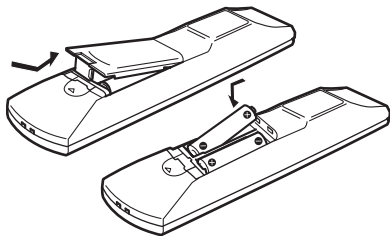

### Notes

- Do not leave the remote in an extremely hot or humid place.
- Do not use a new battery with old ones.
- Do not mix alkaline batteries and other kinds of batteries.
- Do not expose the remote sensor to direct sunlight or lighting apparatuses. Doing so may cause a malfunction.
- If you do not intend to use the remote for an extended period of time, remove the batteries to avoid possible damage from battery leakage and corrosion.
- When you replace the batteries, the remote buttons may be reset to their factory settings. If this happens, reassign the button, again (page 54).

### Tip

Under normal conditions, the batteries should last for about 3 months. When the remote no longer operates the receiver, replace all the batteries with new ones.

## 6: Calibrating the appropriate settings automatically (AUTO CALIBRATION)

This receiver is equipped with D.C.A.C. (Digital Cinema Auto Calibration) Technology which allows you to perform automatic calibration as follows:

- Check the connection between each speaker and the receiver.
- Adjust the speaker level.
- Measure the distance of each speaker to your listening position.

You can also adjust the speaker levels and balance manually. For details, see “7: Adjusting the speaker levels and balance (TEST TONE)” (page 27)

### Before you perform Auto Calibration

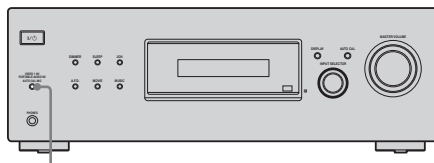

1

- 1 **Connect the supplied optimizer microphone to the VIDEO 1 IN/PORTABLE AUDIO IN/AUTO CAL MIC jack.**
- 2 **Place the optimizer microphone at your listening position.**
- 3 **Place the speakers so that the speakers are facing the optimizer microphone.**



## Tips

- You can also fix the optimizer microphone to a tripod (not supplied) and place the tripod at your listening position.
- Be sure to remove any obstacles in the path between the optimizer microphone and the speakers.
- When you face the speaker towards the optimizer microphone, you will get a more accurate measurement.

## Performing Auto Calibration

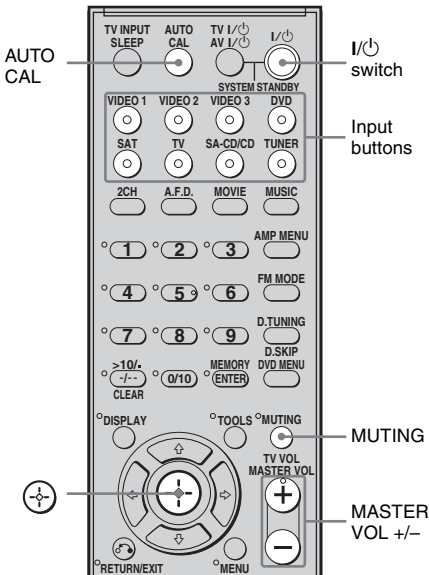

### Press AMP MENU, then press AUTO CAL.

The following appears on the display.

A.CAL [5] → A.CAL [4] → A.CAL [3] →  
A.CAL [2] → A.CAL [1]

The measurement process will take a few minutes to complete.

The table below shows the display when measurement starts.

Measurement for	Display
Environment noise level	NOISE.CHK
Speaker connection	MEASURE and SP DET. appears alternately*
Speaker level	MEASURE and GAIN appears alternately*
Speaker distance	MEASURE and DISTANCE appears alternately*

\* The corresponding speaker indicator lights up in the display during measurement.

When measurement ends, “COMPLETE” appears on the display and the settings are registered.

## After you have finished

Disconnect the optimizer microphone from the receiver.

## Notes

- Auto Calibration cannot detect the sub woofer. Therefore, the sub woofer settings will be maintained.
- You cannot select Auto Calibration when the headphone is connected.

## Tips

- When Auto Calibration starts:
  - Stand some distance away from the speakers and the listening position to avoid measurement failure. This is because test signals are output from the speakers during measurement.
  - Avoid making noise to get a more accurate measurement.
- The Auto Calibration function will be canceled when you do the following during the measurement process:
  - Press I/⏻, input buttons or MUTING.
  - Change the volume level.
  - Press AUTO CAL again.

## Error and warning codes

### Error codes

When an error is detected during Auto Calibration, an error code will appear on the display cyclically after each measurement process as follow:

Error code → blank display → (error code → blank display)<sup>a)</sup> → PUSH → blank display → ENTER

<sup>a)</sup> Appears when there are more than one error code.

### To rectify the error

- 1 Record down the error code.
- 2 Press ⊕.
- 3 Press I/⏏ to turn off the receiver.
- 4 Rectify the error.  
For details, see “Error codes and remedies” below.
- 5 Turn on the receiver and perform Auto Calibration again (page 25).

### Error codes and remedies

Error code	Explanation	Remedy
ERROR 10	The environment is too noisy.	Make sure the environment is quiet during Auto Calibration.
ERROR 11	The speakers are placed too near the optimizer microphone.	Place your speakers further away from the optimizer microphone.
ERROR 12	None of the speakers are detected.	Make sure that the optimizer microphone is connected properly and perform Auto Calibration.
ERROR 20	The front speakers are not detected or only one front speaker is detected.	Check the front speakers connection.
ERROR 21	Only one surround speaker is detected.	Check the surround speakers connection.

### Warning codes

During Auto Calibration, the warning code provides information on the measurement result. The warning code will appear on the display cyclically as follows:

Warning code → blank display → (warning code → blank display)<sup>b)</sup> → PUSH → blank display → ENTER

<sup>b)</sup> Appears when there are more than one warning code.

You can choose to ignore the warning code as the Auto Calibration function will automatically adjust the settings. You can also change the settings manually.

### To change the settings manually

- 1 Record down the warning code.
- 2 Press ⊕.
- 3 Press I/⏏ to turn off the receiver.
- 4 Follow the solution provided in the “Warning codes and solutions” (page 27).
- 5 Turn on the receiver and perform Auto Calibration again (page 25).

## Warning codes and solutions

Warning code	Explanation	Solution
WARN. 40	The environment is noisy.	Make sure the environment is quiet during Auto Calibration.
WARN. 50	The center speaker is not connected.	Be sure to connect the center speaker.
WARN. 51	The surround speakers are not connected.	Be sure to connect the surround speakers.
WARN. 60	The front speakers balance are out of range.	Reposition your front speakers. <sup>e)</sup>
WARN. 62	The center speaker level is out of range.	Reposition your center speaker. <sup>d)</sup>
WARN. 63	The surround left speaker level is out of range.	Reposition your surround left speaker. <sup>e)</sup>
WARN. 64	The surround right speaker level is out of range.	Reposition your surround right speaker. <sup>f)</sup>
WARN. 70	The front speakers distance are out of range.	Reposition your front speakers. <sup>e)</sup>
WARN. 72	The center speaker distance is out of range.	Reposition your center speaker. <sup>d)</sup>
WARN. 73	The surround left speaker distance is out of range.	Reposition your surround left speaker. <sup>e)</sup>
WARN. 74	The surround right speaker distance is out of range.	Reposition your surround right speaker. <sup>f)</sup>

<sup>e)</sup>For details, refer “Front speakers distance” (page 38).  
<sup>d)</sup>For details, refer “Center speaker distance” (page 38).  
<sup>e)</sup>For details, refer “Surround left speaker distance” (page 39).  
<sup>f)</sup>For details, refer “Surround right speaker distance” (page 39).

## 7: Adjusting the speaker levels and balance (TEST TONE)

You can adjust the speaker levels and balance while listening to the test tone from your listening position.

**Tip**  
 The receiver employs a test tone with a frequency centered at 800 Hz.

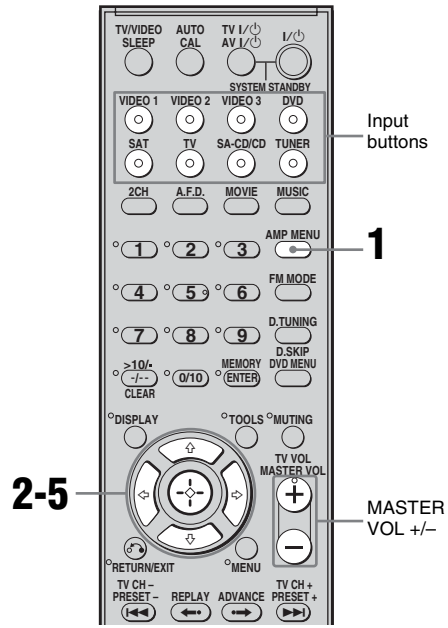

- 1** Press **AMP MENU**.  
 “1-LEVEL” appears on the display.
- 2** Press **⬆** or **➡** to enter the menu.
- 3** Press **⬆/⬆** repeatedly to select “T. TONE”.
- 4** Press **⬆** or **➡** to enter the parameter.

continued

## **5 Press $\uparrow/\downarrow$ repeatedly to select “T. TONE Y”.**

The test tone is output from each speaker in sequence as follows:

Front left → Center → Front right →  
Surround right → Surround left → Sub  
woofer

## **6 Adjust the speaker levels and balance using the LEVEL menu so that the level of the test tone sounds the same from each speaker.**

For details, see “Adjusting the level (LEVEL menu)” (page 35).

### **Tips**

- To adjust the level of all speakers at the same time, press MASTER VOL +/- . You can also use MASTER VOLUME on the receiver.
- The adjusted value are shown on the display during adjustment.

## **To turn off the test tone**

Repeat steps 1 to 5 above to select “T. TONE N”. You can also press any input buttons.

## Selecting a component

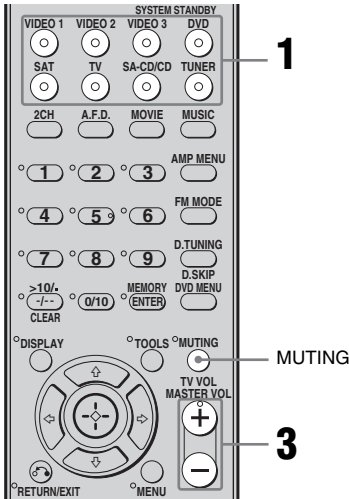

### 1 Press the input button to select a component.

You can also use INPUT SELECTOR on the receiver.  
The selected input appears on the display.

Selected input [Display]	Components that can be played back
VIDEO 1 [VIDEO 1/ PORTABLE AUDIO]*	MP3 player, etc., connected to the VIDEO 1 IN/ PORTABLE AUDIO IN/ AUTO CAL MIC jack
VIDEO 2 [VIDEO 2/ BD]*	Blu-ray disc player, etc., connected to the VIDEO 2/BD jack
DVD [DVD]	DVD player, etc., connected to DVD jack
SA-CD/CD [SA-CD/CD]	Super Audio CD/CD player, etc., connected to the SA-CD/CD jack
TV [TV]	TV, etc. connected to the TV jack
SAT [SAT]	Satellite tuner, etc. connected to the SAT jack
TUNER [FM or AM band]	Built-in radio tuner

\* “VIDEO 1/PORTABLE AUDIO” and “VIDEO 2/BD” scroll across the display, then “VIDEO 1” and “VIDEO 2” appear.

### 2 Turn on the component and start playback.

### 3 Press MASTER VOL +/- to adjust the volume.

You can also use MASTER VOLUME on the receiver.

### To mute the sound

Press MUTING.

The muting function will be canceled when you do the following.

- Press MUTING again.
- Increase the volume.
- Turn off the receiver.

### To avoid damaging your speakers

Before you turn off the receiver, be sure to turn down the volume level.

# Listening/Watching a component

## Listening to a Super Audio CD/CD

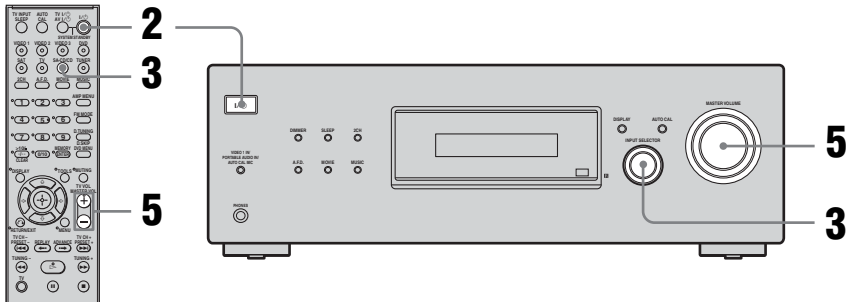

### Notes

- The operation is described for a Sony Super Audio CD player.
- Refer to the operating instructions supplied with the Super Audio CD player or CD player.

### Tips

- You can select the sound field to suit the music. Refer to page 43 for details.  
Recommended sound fields:  
Classical: HALL  
Jazz: JAZZ  
Live concert: CONCERT
- You can listen to the sound that was recorded in the 2 channel format from all speakers (multi channel). Refer to page 41 for details.

- 1 Turn on the Super Audio CD player/CD player, then place the disc on the tray.**
- 2 Turn on the receiver.**
- 3 Press SA-CD/CD.**  
You can also use INPUT SELECTOR on the receiver to select "SA-CD/CD".
- 4 Playback the disc.**
- 5 Adjust to a suitable volume.**
- 6 After you have finished listening to the Super Audio CD/CD, eject the disc and turn off the receiver and Super Audio CD player/ CD player.**

## Watching a DVD

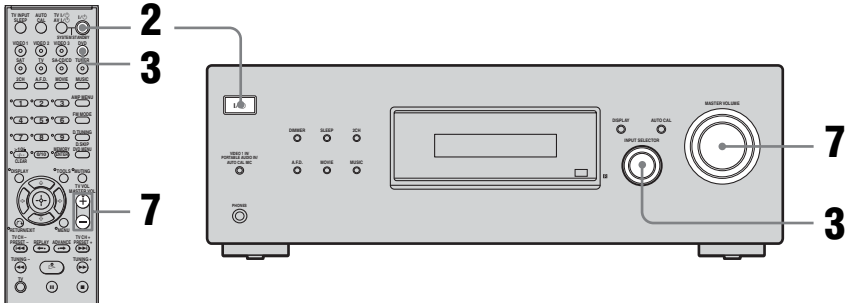

### Notes

- Refer to the operating instructions supplied with the TV and DVD player.
- Check the following if you cannot listen to multi channel sound.
  - Be sure this receiver is connected to the DVD player via a digital connection.
  - Be sure the digital audio output of the DVD player is set up properly.

### Tips

- Select the sound format of the disc to be played, if necessary.
- You can select the sound field to suit the movie/music. Refer to page 43 for details.  
Recommended sound fields:  
Movie: C.ST.EX  
Music: CONCERT

**1** Turn on the TV and DVD player.

**2** Turn on the receiver.

**3** Press DVD.

You can also use INPUT SELECTOR on this receiver to select “DVD”.

**4** Switch the input of the TV so that an image of the DVD is displayed.

If no image is displayed on the TV screen, make sure that the video output of the DVD player is connected to the TV.

**5** Set up the DVD player.

Refer to “Quick Setup Guide” supplied with the receiver.

**6** Playback the disc.

**7** Adjust to a suitable volume.

**8** After you have finished watching the DVD, eject the disc and turn off the receiver, TV and DVD player.

## Amplifier Operations

### Navigating through menus

By using the amplifier menus, you can make various adjustments to customize the receiver.

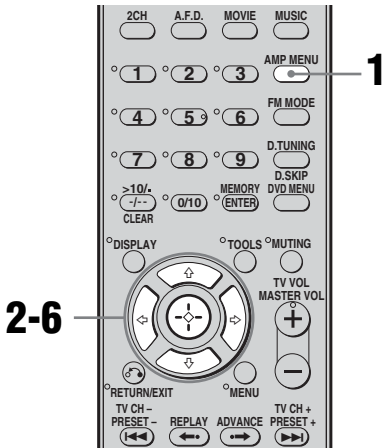

### To return to the previous display

Press **←**.

### To exit the menu

Press AMP MENU.

### Note

Some parameters and settings may appear dimmed on the display. This means that they are either unavailable or fixed and unchangeable.

#### 1 Press AMP MENU.

“1-LEVEL” appears on the display.

#### 2 Press **↑/↓** repeatedly to select the menu you want.

#### 3 Press **⊕** or **→** to enter the menu.

#### 4 Press **↑/↓** repeatedly to select the parameter you want to adjust.

#### 5 Press **⊕** or **→** to enter the parameter.

#### 6 Press **↑/↓** repeatedly to select the setting you want.

The setting is applied automatically.



## Overview of the menus

The following options are available in each menu. For details on navigating through menus, see page 32.

Menu [Display]	Parameters [Display]	Settings	Initial setting
LEVEL (35) [1-LEVEL]	Test tone <sup>a)</sup> [T. TONE]	T. TONE Y, T. TONE N	T. TONE N
	Front speaker balance <sup>a)</sup> [FRT BAL]	BAL. L +1 to BAL. L +8, BALANCE, BAL. R +1 to BAL. R +8	BALANCE
	Center speaker level [CNT LVL]	CNT -10 dB to CNT +10 dB (1 dB step)	CNT 0 dB
	Surround left speaker level [SL LVL]	SUR L -10 dB to SUR L +10 dB (1 dB step)	SUR L 0 dB
	Surround right speaker level [SR LVL]	SUR R -10 dB to SUR R +10 dB (1 dB step)	SUR R 0 dB
	Sub woofer level [SW LVL]	SW -10 dB to SW +10 dB (1 dB step)	SW 0 dB
	Dynamic range compressor <sup>a)</sup> [D. RANGE]	COMP. OFF, COMP. STD, COMP. MAX	COMP. OFF
TONE (36) [2-TONE]	Front speaker bass level [BASS LVL]	BASS -6 dB to BASS +6 dB (1 dB step)	BASS 0 dB
	Front speaker treble level [TRE LVL]	TRE -6 dB to TRE +6 dB (1 dB step)	TRE 0 dB
SUR (36) [3-SUR]	Sound field selection <sup>a)</sup> [S.F. SELCT]	2CH ST., A.F.D. AUTO, DOLBY PL, PLII MV, PLII MS, MULTI ST., C.ST.EX A, C.ST.EX B, C.ST.EX C, PORTABLE, HALL, JAZZ, CONCERT	A.F.D. AUTO
	Effect level <sup>a)b)</sup> [EFFECT]	EFCT. MIN, EFCT. STD, EFCT. MAX	EFCT. STD
TUNER (37) [4-TUNER]	FM station receiving mode <sup>a)</sup> [FM MODE]	FM AUTO, FM MONO	FM AUTO
	Naming preset stations <sup>a)</sup> [NAME IN]		

<b>Menu [Display]</b>	<b>Parameters [Display]</b>	<b>Settings</b>	<b>Initial setting</b>
AUDIO (37) [5-AUDIO]	Digital audio input decoding priority <sup>a)</sup> [DEC. PRI.]	DEC. AUTO, DEC. PCM	DEC. AUTO for: VIDEO 2; DEC. PCM for: DVD
	Digital broadcast language selection <sup>a)</sup> [DUAL]	DUAL M/S, DUAL M, DUAL S, DUAL M+S	DUAL M
	Synchronizes audio with video output <sup>a)</sup> [A.V. SYNC.]	A.V.SYNC. Y, A.V.SYNC. N	A.V.SYNC. N
	Naming inputs <sup>a)</sup> [NAME IN]		
SYSTEM (38) [6-SYSTEM]	Front speakers distance <sup>a)</sup> [FRT DIST.]	DIST. 1.0 m to DIST. 7.0 m (0.1 m step)	DIST. 3.0 m
	Center speaker distance <sup>a)</sup> [CNT DIST.]	DIST. ■■ m between front speaker distance and 1.5 m (0.1 m step)	DIST. 3.0 m
	Surround left speaker distance <sup>a)</sup> [SL DIST.]	DIST. ■■ m between front speaker distance and 4.5 m (0.1 m step)	DIST. 3.0 m
	Surround right speaker distance <sup>a)</sup> [SR DIST.]	DIST. ■■ m between front speaker distance and 4.5 m (0.1 m step)	DIST. 3.0 m
	Surround speaker position <sup>a)</sup> [SUR POS.]	SIDE/LO, SIDE/HI, BEHD/LO, BEHD/HI	SIDE/LO
	Brightness of the display <sup>a)</sup> [DIMMER]	0% dim, 40% dim, 70% dim	0% dim
A. CAL (40) [7-A. CAL]	Auto calibration <sup>a)</sup> [AUTO CAL]	A.CAL YES, A.CAL NO	A.CAL NO

<sup>a)</sup>For details, refer to the page in the parentheses.

<sup>b)</sup>The surround effect is not available for “PORTABLE” sound field.

## Adjusting the level

### (LEVEL menu)

You can use the LEVEL menu to adjust the balance and level of each speaker. These settings are applied to all sound fields. Select “1-LEVEL” in the amplifier menus. For details on adjusting the parameters, see “Navigating through menus” (page 32) and “Overview of the menus” (page 33).

### LEVEL menu parameters

#### ■ T. TONE (Test tone)

Lets you adjust the speaker levels and balance while listening to the test tone from your listening position. For details, see “7: Adjusting the speaker levels and balance (TEST TONE)” (page 27).

#### ■ FRT BAL (Front speaker balance)

Lets you adjust the balance between front left and right speakers.

#### ■ CNT LVL (Center speaker level)

#### ■ SL LVL (Surround left speaker level)

#### ■ SR LVL (Surround right speaker level)

#### ■ SW LVL (Sub woofer level)

#### ■ D. RANGE (Dynamic range compressor)

Lets you compress the dynamic range of the sound track. This may be useful when you want to watch movies at low volumes late at night. Dynamic range compression is possible with Dolby Digital sources only.

- COMP. OFF  
The dynamic range is not compressed.
- COMP. STD  
The dynamic range is compressed as intended by the recording engineer.
- COMP. MAX  
The dynamic range is compressed dramatically.

#### Tip

Dynamic range compressor lets you compress the dynamic range of the soundtrack based on the dynamic range information included in the Dolby Digital signal. “COMP. STD” is the standard setting, but it only enacts light compression. Therefore, we recommend using the “COMP. MAX” setting. This greatly compresses the dynamic range and lets you view movies late at night at low volumes. Unlike analog limiters, the levels are predetermined and provide a very natural compression.

## Adjusting the tone (TONE menu)

You can use the TONE menu to adjust the tonal quality (bass/treble level) of the front speakers. These settings are applied to all sound fields.

Select “2-TONE” in the amplifier menus. For details on adjusting the parameters, see “Navigating through menus” (page 32) and “Overview of the menus” (page 33).

### TONE menu parameters

- **BASS LVL (Front speaker bass level)**
- **TRE LVL (Front speaker treble level)**

## Settings for the surround sound (SUR menu)

You can use the SUR menu to select the sound field you want for your listening pleasure. Select “3-SUR” in the amplifier menus. For details on adjusting the parameters, see “Navigating through menus” (page 32) and “Overview of the menus” (page 33).

### SUR menu parameters

#### ■ **S.F. SELCT (Sound field selection)**

Lets you select the sound field you want. For details, see “Enjoying Surround Sound” (page 41).

#### **Note**

The receiver lets you apply the last selected sound field to an input whenever it is selected (Sound Field Link). For example, if you select “HALL” for the SA-CD/CD input, then change to a different input and then return to SA-CD/CD, “HALL” will automatically be applied again.

#### ■ **EFFECT (Effect level)**

Lets you adjust the “presence” of the surround effect for sound fields selected with the MOVIE or MUSIC button and for “HP THEA” sound field. However, the surround effect is not available for “PORTABLE” sound field.

- **EFCT. MIN**  
The surround effect is minimum.
- **EFCT. STD**  
The surround effect is standard.
- **EFCT. MAX**  
The surround effect is maximum.

## Settings for the tuner

### (TUNER menu)

You can use the TUNER menu to set the FM station receiving mode and to name preset stations.

Select “4-TUNER” in the amplifier menus. For details on adjusting the parameters, see “Navigating through menus” (page 32) and “Overview of the menus” (page 33).

### TUNER menu parameters

#### ■ FM MODE (FM station receiving mode)

- FM AUTO

This receiver will decode the signal as stereo signal when the radio station is broadcast in stereo.

- FM MONO

This receiver will decode the signal as mono signal regardless of the broadcast signal.

#### ■ NAME IN (Naming preset stations)

Lets you set the name of preset stations. For details, see “Naming preset stations” (page 50).

## Settings for the audio

### (AUDIO menu)

You can use the AUDIO menu to make settings for the audio to suit your preference. Select “5-AUDIO” in the amplifier menus. For details on adjusting the parameters, see “Navigating through menus” (page 32) and “Overview of the menus” (page 33).

### AUDIO menu parameters

#### ■ DEC. PRI. (Digital audio input decoding priority)

Lets you specify the input mode for the digital signal input to the DIGITAL IN jacks.

- DEC. AUTO

Automatically switches the input mode between DTS, Dolby Digital or PCM.

- DEC. PCM

PCM signals are given priority (to prevent interruption when playback starts).

However, when other signals are input, there may be no sound depending on the format.

In this case, set to “DEC. AUTO”.

#### Note

When set to “DEC. AUTO” and the sound from the digital audio jacks (for CD, etc.) is interrupted when playback starts, set to “DEC. PCM”.

## ■ DUAL (Digital broadcast language selection)

Lets you select the language you want to listen to during digital broadcast. This feature only functions for Dolby Digital sources.

- DUAL M/S (Main/Sub)  
Sound of the main language will be output through the front left speaker and sound of the sub language will be output through the front right speaker simultaneously.
- DUAL M (Main)  
Sound of the main language will be output.
- DUAL S (Sub)  
Sound of the sub language will be output.
- DUAL M+S (Main + Sub)  
Mixed sound of both the main and sub languages will be output.

## ■ A.V. SYNC. (Synchronizes audio with video output)

- A.V.SYNC. Y (Yes) (Delay time: 68 ms)  
The audio output is delayed so that the time gap between the audio output and visual display is minimized.
- A.V.SYNC. N (No) (Delay time: 0 ms)  
The audio output is not delayed.

### Notes

- This parameter is useful when you use a large LCD or plasma monitor or a projector.
- This parameter is valid only when you use a sound field selected with the 2CH or A.F.D. buttons.
- This parameter is not valid when PCM 96 kHz or DTS 2048 signals are input.

## ■ NAME IN (Naming inputs)

Lets you set the name of inputs. For details, see “Naming inputs” (page 53).

# Settings for the system (SYSTEM menu)

You can use the SYSTEM menu to set the distance of the speakers connected to this system.

Select “6-SYSTEM” in the amplifier menus. For details on adjusting the parameters, see “Navigating through menus” (page 32) and “Overview of the menus” (page 33).

## SYSTEM menu parameters

### ■ FRT DIST. (Front speakers distance)

Lets you set the distance from your listening position to the front speakers (A).

If both front speakers are not placed an equal distance from your listening position, set the distance as the average distance between the front speakers.

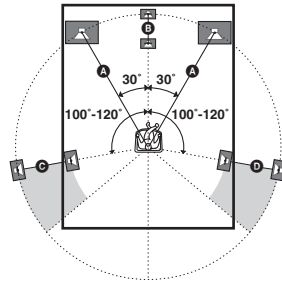

### ■ CNT DIST. (Center speaker distance)

Lets you set the distance from your listening position to the center speaker. Center speaker distance should be set from a distance equal to the front speaker distance (A) to a distance 1.5 meters closer to your listening position (B).

■ **SL DIST. (Surround left speaker distance)**

Lets you set the distance from your listening position to the surround left speaker. Surround left speaker distance should be set from a distance equal to the front speaker distance (A on page 38) to a distance 4.5 meters closer to your listening position (C on page 38).

■ **SR DIST. (Surround right speaker distance)**

Lets you set the distance from your listening position to the surround right speaker. Surround right speaker distance should be set from a distance equal to the front speaker distance (A on page 38) to a distance 4.5 meters closer to your listening position (D on page 38).

**Tip**

The receiver lets you to input the speaker position in terms of distance. However, it is not possible to set the center speaker further than the front speakers. Also, the center speaker cannot be set more than 1.5 meters closer from the front speakers. Likewise, the surround speakers can not be set further away from the listening position than the front speakers. And they can be no more than 4.5 meters closer. This is because incorrect speaker placement is not conducive to the enjoyment of surround sound.

Please note that, setting the speaker distance closer than the actual location of the speakers will cause a delay in the output of the sound from that speaker. In other words, the speaker will sound like it is further away.

For example, setting the center speaker distance 1-2 meters closer than the actual speaker position will create a fairly realistic sensation of being "inside" the screen. If you cannot obtain a satisfactory surround effect because the surround speakers are too close, setting the surround speaker distance closer (shorter) than the actual distance will create a larger sound stage.

Adjusting these parameter while listening to the sound often results in much better surround sound. Give it a try!

■ **SUR POS. (Surround speaker position)**

Lets you specify the location of your surround speakers for proper implementation of the surround effects in the Cinema Studio EX modes (page 44).

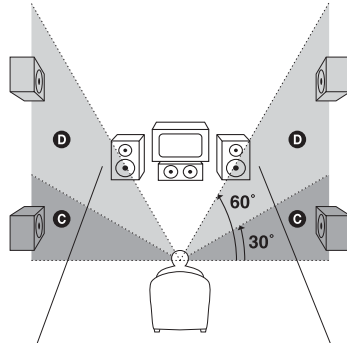
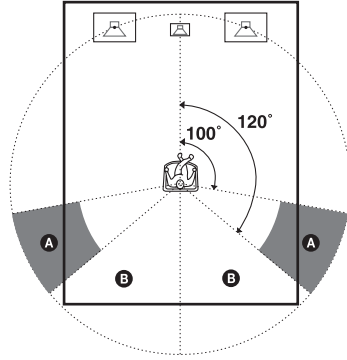

- **SIDE/LO**  
Select if the location of your surround speakers corresponds to sections **A** and **C**.
- **SIDE/HI**  
Select if the location of your surround speakers corresponds to sections **A** and **D**.
- **BEHD/LO**  
Select if the location of your surround speakers corresponds to sections **B** and **C**.
- **BEHD/HI**  
Select if the location of your surround speakers corresponds to sections **B** and **D**.

## Tip

Surround speaker position is designed specifically for implementation of the Cinema Studio EX modes. For other sound fields, speaker position is not so critical.

Those sound fields were designed under the premise that the surround speakers would be located behind the listening position, but presentation remains fairly consistent even with the surround speakers positioned at a rather wide angle. However, if the speakers are pointing toward the listener from the immediate left and right of the listening position, the surround effects become unclear unless set to “SIDE/LO” or “SIDE/HI”.

Nevertheless, each listening environment has many variables, such as wall reflections, and you may obtain better results using “BEHD/HI” if your speakers are located high above the listening position, even if they are located to the immediate left and right.

Therefore, although it may result in a setting contrary to the above explanation, we recommend that you playback multi channel surround encoded software and select the setting that provides a good sense of spaciousness and that best succeeds in forming a cohesive space between the surround sound from the surround speakers and the sound of the front speakers. If you are not sure which sounds best, select “BEHD/LO” or “BEHD/HI” and then use the speaker distance parameter and speaker level adjustments to obtain proper balance.

## ■ DIMMER (Brightness of the display)

Lets you adjust the brightness in 3 steps.

# Calibrating the appropriate settings automatically

## (A. CAL menu)

For details, see “6: Calibrating the appropriate settings automatically (AUTO CALIBRATION)” (page 24).



## Enjoying Surround Sound

# Enjoying Dolby Digital and DTS Surround sound (AUTO FORMAT DIRECT)

The Auto Format Direct (A.F.D.) mode allows you to listen to higher fidelity sound and select the decoding mode for listening to a 2 channel stereo sound as multi channel sound.

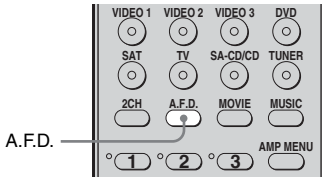

**Press A.F.D. repeatedly to select the sound field you want.**

For details, see “Types of A.F.D. mode” (page 42).

## Types of A.F.D. mode

<b>Decoding mode</b>	<b>A.F.D. mode [Display]</b>	<b>Multi channel audio after decoding</b>	<b>Effect</b>
(Detecting automatically)	A.F.D. AUTO [A.F.D. AUTO]	(Detecting automatically)	Performs the sound as it was recorded/ encoded without adding any surround effects. However, this receiver will generate a low frequency signal for output to the sub woofer when there is no LFE signals.
Dolby Pro Logic	PRO LOGIC [DOLBY PL]	4 channel	Performs Dolby Pro Logic decoding. The source recorded in 2 channel format is decoded into 4.1 channels.
Dolby Pro Logic II	PRO LOGIC II MOVIE [PLII MV]	5 channel	Performs Dolby Pro Logic II Movie mode decoding. This setting is ideal for movies encoded in Dolby Surround. In addition, this mode can reproduce sound in 5.1 channel for watching videos of overdubbed or old movies.
	PRO LOGIC II MUSIC [PLII MS]	5 channel	Performs Dolby Pro Logic II Music mode decoding. This setting is ideal for normal stereo sources such as CDs.
(Multi Stereo)	MULTI STEREO [MULTI ST.]	(Multi Stereo)	Outputs 2 channel left/right signals from all speakers.

# Selecting a pre-programmed sound field

You can take advantage of surround sound simply by selecting one of the receiver's pre-programmed sound fields. They bring the exciting and powerful sound of movie theaters and concert halls into your home.

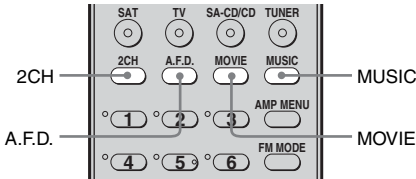

**Press MOVIE repeatedly to select a sound field for movies or press MUSIC repeatedly to select a sound field for music.**

For details, see “Types of sound field available” (page 44).

## Types of sound field available

Sound field for	Sound field [Display]	Effect
Movie	CINEMA STUDIO EX A <b>DCS</b> [C.ST.EX A]	Reproduces the sound characteristics of the Sony Pictures Entertainment "Cary Grant Theater" cinema production studio. This is a standard mode, great for watching almost any type of movie.
	CINEMA STUDIO EX B <b>DCS</b> [C.ST.EX B]	Reproduces the sound characteristics of the Sony Pictures Entertainment "Kim Novak Theater" cinema production studio. This mode is ideal for watching science-fiction or action movies with lots of sound effects.
	CINEMA STUDIO EX C <b>DCS</b> [C.ST.EX C]	Reproduces the sound characteristics of the Sony Pictures Entertainment scoring stage. This mode is ideal for watching musicals or films where orchestra music is featured in the soundtrack.
Music	PORTABLE AUDIO [PORTABLE]	Reproduces a clear enhanced sound image from your portable audio device. This mode is ideal for MP3 and other compressed music.
	HALL [HALL]	Reproduces the acoustics of a classical concert hall.
	JAZZ CLUB [JAZZ]	Reproduces the acoustics of a jazz club.
	LIVE CONCERT [CONCERT]	Reproduces the acoustics of a 300-seat live house.
Headphone*	HEADPHONE 2CH [HP 2CH]	This mode is selected automatically if you use headphone when 2 channel mode (page 46)/A.F.D. mode (page 42) is selected. Standard 2 channel stereo sources completely bypass the sound field processing and multi channel surround formats are downmixed to 2 channels.
	HEADPHONE THEATER <b>DCS</b> [HP THEA]	This mode is selected automatically if you use headphone when sound field for movie/music is selected. It allows you to experience a theater-like environment while listening through a pair of headphones.

\* You can only select the sound field mode if the headphones are connected to the receiver.

## About DCS (Digital Cinema Sound)

Sound fields with **DCS** mark use DCS technology. DCS is a unique sound reproduction technology for home theater developed by Sony, in cooperation with Sony Pictures Entertainment, for enjoying the exciting and powerful sound of movie theaters at home. With this “Digital Cinema Sound” developed by integrating a DSP (Digital signal processor) and measured data, the ideal sound field intended by filmmakers can be experienced at home.

## About CINEMA STUDIO EX modes

CINEMA STUDIO EX modes are suitable for watching motion picture DVDs (etc.), with multi channel surround effects. You can reproduce the sound characteristics of Sony Pictures Entertainment’s dubbing studio in your home.

The CINEMA STUDIO EX modes consist of the following three elements.

- Virtual Multi Dimension  
Creates 5 sets of virtual speakers from a single pair of actual surround speakers.
- Screen Depth Matching  
Creates the sensation that the sound is coming from inside the screen like in theaters.
- Cinema Studio Reverberation  
Reproduces the type of reverberation found in theaters.



The CINEMA STUDIO EX modes integrate these three elements simultaneously.

### Notes

- The effects provided by the virtual speakers may cause increased noise in the playback signal.
- When listening with sound fields that employ the virtual speakers, you will not be able to hear any sound coming directly from the surround speakers.
- This function does not work for signals with a sampling frequency of more than 48 kHz.

### Tip

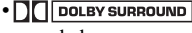
You can identify the encoding format of DVD software, etc., by looking at the logo on the package.

-  : Dolby Digital discs
-  : Dolby Surround encoded programs
-  : DTS Digital Surround encoded programs

## To turn off the surround effect for movie/music

Press 2CH to select “2CH ST.” or press A.F.D. repeatedly to select “A.F.D. AUTO”.

## Using only the front speakers and sub woofer (2CH STEREO)

In this mode, the receiver outputs the sound from the front left/right speakers and sub woofer.

When multi channel surround formats are input, the signals are downmixed to 2 channel with bass frequencies being output from the sub woofer.

When standard 2 channel stereo sources are input, the receiver's bass redirection circuitry will be activated. The front channel bass frequencies will be output from the sub woofer.

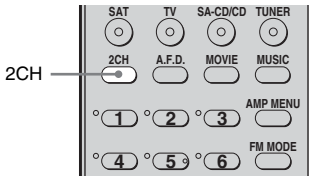

**Press 2CH.**

## Resetting sound fields to the initial settings

Be sure to use the buttons on the receiver for this operation.

**1,2**

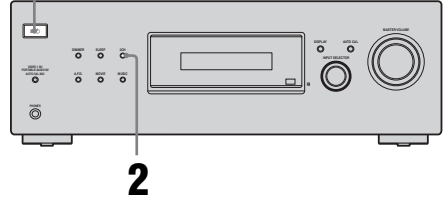

**1** Press I/⏻ to turn off the receiver.

**2** While holding down 2CH, press I/⏻.

“S.F. CLR.” appears on the display and all sound fields are reset to their initial setting.

## Tuner Operations

### Listening to FM/AM radio

You can listen to FM and AM broadcasts through the built-in tuner. Before operation, make sure you have connected the FM and AM antennas to the receiver (page 22).

#### Tip

The tuning scale differs depending on the area code as shown in the following table. For details on area codes, see page 3.

Area code	FM	AM
CEL, CEK	50 kHz	9 kHz

## Automatic tuning

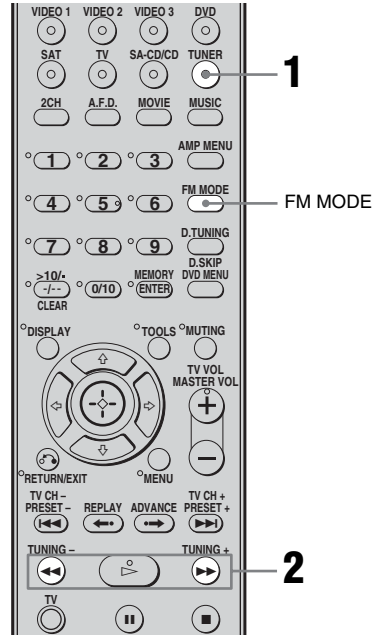

### 1 Press TUNER repeatedly to select the FM or AM band.

You can also use INPUT SELECTOR on the receiver.

### 2 Press TUNING + or TUNING -.

Press TUNING + to scan from low to high; press TUNING - to scan from high to low.

The receiver stops scanning whenever a station is received.

## In case of poor FM stereo reception

If the FM stereo reception is poor and “ST” flashes on the display, select monaural audio so that the sound will be less distorted.

Press FM MODE repeatedly until the “MONO” indicator lights up on the display. To return to stereo mode, press FM MODE repeatedly until the “MONO” indicator on the display does not light up.

## Direct tuning

Enter the frequency of a station directly by using the numeric buttons.

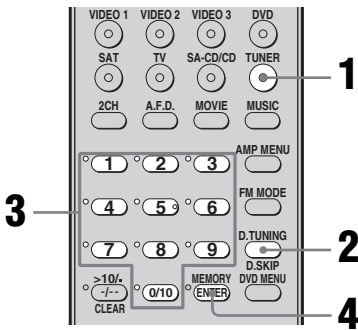

### 1 Press TUNER repeatedly to select the FM or AM band.

You can also use INPUT SELECTOR on the receiver.

### 2 Press D.TUNING.

### 3 Press the numeric buttons to enter the frequency.

Example 1: FM 102.50 MHz

Press 1 ➔ 0 ➔ 2 ➔ 5 ➔ 0

Example 2: AM 1,350 kHz

Press 1 ➔ 3 ➔ 5 ➔ 0

If you have tuned in an AM station, adjust the direction of the AM loop antenna for optimum reception.

### 4 Press ENTER.

## If you cannot tune in a station

Make sure you have entered the right frequency. If not, repeat steps 2 to 4. If you still cannot tune in a station, the frequency is not used in your area.



# Presetting radio stations

You can preset up to 30 FM stations and 30 AM stations. Then you can easily tune in the stations you often listen to.

## Presetting radio stations

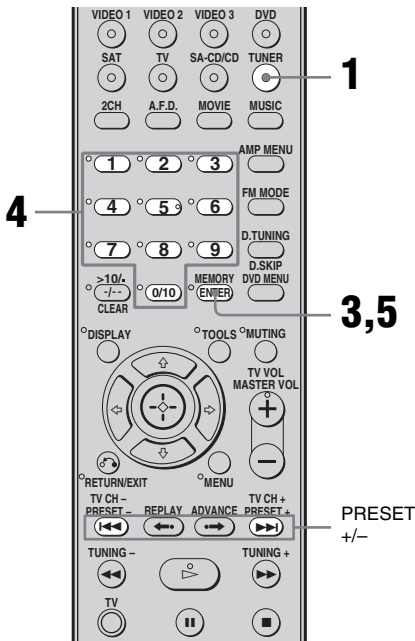

### 3 Press MEMORY.

“MEMORY” lights up for a few seconds. Perform steps 4 and 5 before “MEMORY” goes out.

### 4 Press the numeric buttons to select a preset number.

You can also press PRESET + or PRESET – repeatedly to select a preset number.

If “MEMORY” goes out before you select the preset number, start again from step 3.

### 5 Press ENTER.

The station is stored as the selected preset number.

If “MEMORY” goes out before you press ENTER, start again from step 3.

### 6 Repeat steps 1 to 5 to preset another station.

### 1 Press TUNER repeatedly to select the FM or AM band.

You can also use INPUT SELECTOR on the receiver.

### 2 Tune in the station that you want to preset using Automatic Tuning (page 47) or Direct Tuning (page 48).

Switch the FM reception mode, if necessary (page 48).

## Tuning to preset stations

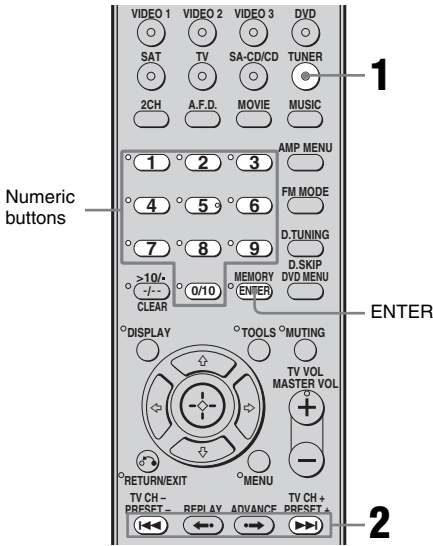

### 1 Press TUNER repeatedly to select the FM or AM band.

You can also use INPUT SELECTOR on the receiver.

### 2 Press PRESET + or PRESET - repeatedly to select the preset station you want.

Each time you press the button, you can select a preset station as follows:

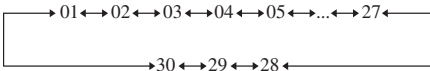

You can also press the numeric buttons to select the preset station you want. Then, press ENTER to enter the selection.

## Naming preset stations

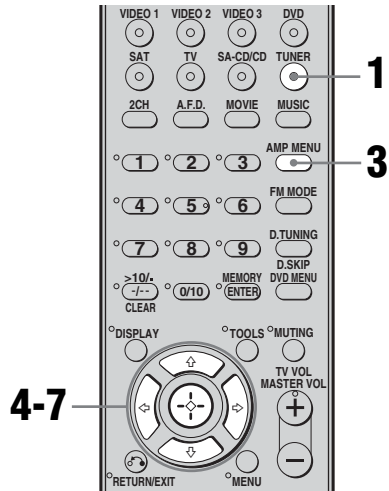

### 1 Press TUNER repeatedly to select the FM or AM band.

You can also use INPUT SELECTOR on the receiver.

### 2 Tune in the preset station you want to create an index name for (page 50).

### 3 Press AMP MENU.

“1-LEVEL” appears on the display.

### 4 Press $\uparrow/\downarrow$ repeatedly to select “4-TUNER”.

### 5 Press $\left(\oplus\right)$ or $\rightarrow$ to enter the menu.

### 6 Press $\uparrow/\downarrow$ repeatedly to select “NAME IN”.

### 7 Press $\left(\oplus\right)$ or $\rightarrow$ to enter the parameter.

The cursor flashes and you can select a character. Follow the procedure given in “To create an index name” (page 51).

## To create an index name

- 1 Use **▲/▼/◀/▶** to create an index name.  
Press **▲/▼** to select a character, then press **◀/▶** to move the cursor to the next position.

### If you made a mistake

Press **◀/▶** until the character you want to change flashes, then press **▲/▼** to select the correct character.

### Tip

You can select the character type as follows by pressing **▲/▼**.  
Alphabet (upper case) → Numbers → Symbols

- 2 Press **⊕**.

The entered name is registered.

### Note (Models of area code CEL, CEK only)

When you name an RDS station and tune in that station, the Program Service name appears instead of the name you entered. (You cannot change the Program Service name. The name you entered will be overwritten by the Program Service name.)

## Using the Radio Data System (RDS)

### (Models of area code CEL, CEK only)

This receiver also allows you to use RDS (Radio Data System), which enables radio stations to send additional information along with the regular program signal. You can display RDS information.

### Notes

- RDS is operable only for FM stations.
- Not all FM stations provide RDS service, nor do they provide the same type of services. If you are not familiar with the RDS services in your area, check with your local radio stations for details.

### Receiving RDS broadcasts

**Simply select a station on the FM band using direct tuning (page 48), automatic tuning (page 47), or preset tuning (page 50).**

When you tune in a station that provides RDS services, “RDS” lights up and the program service name appears on the display.

### Note

RDS may not work properly if the station you tuned to is not transmitting the RDS signal properly or if the signal strength is weak.

## Displaying RDS information

**While receiving an RDS station, press DISPLAY repeatedly on the receiver.**

Each time you press the button, RDS information on the display changes cyclically as follows:

Program Service name → Frequency → Program Type indication<sup>a)</sup> → Radio Text indication<sup>b)</sup> → Current Time indication (in 24-hour system mode) → Sound field currently applied

<sup>a)</sup>Type of program being broadcast.

<sup>b)</sup>Text messages sent by the RDS station.

### Notes

- If there is an emergency announcement by government authorities, "ALARM" flashes in the display.
- When the message consists of 9 characters or more, the message scrolls across the display.
- If a station does not provide a particular RDS service, "NO XXXX" (such as "NO TEXT") appears on the display.

## Description of program types

Program type indication	Description
NEWS	News programs
AFFAIRS	Topical programs that expand on current news
INFO	Programs offering information on a wide spectrum of subjects, including consumer affairs and medical advice
SPORT	Sports programs
EDUCATE	Educational programs, such as "how-to" and advice programs
DRAMA	Radio plays and serials
CULTURE	Programs about national or regional culture, such as language and social concerns
SCIENCE	Programs about the natural sciences and technology

Program type indication	Description
VARIED	Other types of programs such as celebrity interviews, panel games, and comedy
POP M	Popular music programs
ROCK M	Rock music programs
EASY M	Easy Listening
LIGHT M	Instrumental, vocal, and choral music
CLASSICS	Performances of major orchestras, chamber music, opera, etc.
OTHER M	Music that does not fit into any categories above, such as Rhythm & Blues and Reggae
WEATHER	Weather information
FINANCE	Stock market reports and trading, etc.
CHILDREN	Programs for children
SOCIAL	Programs about people and the things that affect them
RELIGION	Programs of religious content
PHONE IN	Programs where members of the public express their views by phone or in a public forum
TRAVEL	Programs about travel. Not for announcements that are located by TP/TA.
LEISURE	Programs on recreational activities such as gardening, fishing, cooking, etc.
JAZZ	Jazz programs
COUNTRY	Country music programs
NATION M	Programs featuring the popular music of the country or region
OLDIES	Programs featuring oldies music
FOLK M	Folk music programs
DOCUMENT	Investigative features
NONE	Any programs not defined above

### Naming inputs

You can enter a name of up to 8 characters for inputs and display it on the receiver's display. This is convenient for labeling the jacks with the names of the connected components.

#### 1 Press the input button to select the input you want to create an index name for.

You can also use INPUT SELECTOR on the receiver.

#### 2 Press AMP MENU.

"1-LEVEL" appears on the display.

#### 3 Press $\uparrow/\downarrow$ repeatedly to select "5-AUDIO".

#### 4 Press $\odot$ or $\rightarrow$ to enter the menu.

#### 5 Press $\uparrow/\downarrow$ to select "NAME IN".

#### 6 Press $\odot$ or $\rightarrow$ to enter the parameter.

The cursor flashes and you can select a character. Follow the procedure given in "To create an index name" (page 51).

### Changing the display

You can check the sound field, etc., by changing the information on the display. Be sure to use the button on the receiver for this operation.

#### Press DISPLAY repeatedly.

Each time you press the button, the display changes cyclically as follows.

#### All inputs except the FM and AM band

Index name of the input<sup>a)</sup> → Selected input  
→ Sound field currently applied

#### FM and AM band

Program Service name<sup>b)</sup> or preset station name<sup>a)</sup> → Frequency → Program Type indication<sup>b)</sup> → Radio Text indication<sup>b)</sup> → Current Time indication (in 24-hour system mode)<sup>b)</sup> → Sound field currently applied

<sup>a)</sup> Index name appears only when you have assigned one to the input or preset station (page 50, 53). Index name does not appear when only blank spaces have been entered, or it is the same as the input name.

<sup>b)</sup> During RDS reception only (models of area code CEL, CEK only) (page 51).

#### Note

Characters or marks may not be displayed for some languages.

## Using the Sleep Timer

You can set the receiver to turn off automatically at a specified time.

**Press SLEEP repeatedly while the power is on.**

Each time you press the button, the display changes cyclically as follows:

2-00-00 → 1-30-00 → 1-00-00 → 0-30-00  
→ OFF

When sleep timer is activated, the display dims.

### Note

If you press any buttons on the remote or receiver after the display dims, the display brightens up. After a while, the display dims again if no button is pressed.

### Tip

To check the remaining time before the receiver turns off, press SLEEP. The remaining time appears on the display. If you press SLEEP again, the sleep timer will be canceled.

## Using the Remote

### Changing button assignments

You can change the factory settings of the input buttons to suit the components in your system. For example, if you connect a DVD player to the SAT jacks on the receiver, you can set the SAT button on this remote to control the DVD player.

**1 Hold down the input button of which you want to change the assignment.**

Example: Hold down SAT.

**2 Referring to the table below, press the corresponding button for the category you want.**

Example: Press 4.

Now you can use the SAT button to control the DVD player.

## Categories and the corresponding buttons

Categories	Press
VCR (command mode VTR 3) <sup>a)</sup>	1
VCR (command mode VTR 2) <sup>a)</sup>	2
DVD player/DVD recorder (command mode DVD1) <sup>b)</sup>	3
DVD recorder (command mode DVD3) <sup>b)</sup>	4
CD player	5
Euro Digital Satellite Receiver	6
DVR (Digital CATV terminal)	7
DSS (Digital Satellite Receiver)	8
Blu-ray disc player (command mode BD1) <sup>c)</sup>	9
Blu-ray disc recorder (command mode BD3) <sup>c)</sup>	0/10
TV	-/--
Not assigned	ENTER/ MEMORY

<sup>a)</sup> Sony VCRs are operated with a VTR 2 or VTR 3 setting which corresponds to 8 mm and VHS respectively.

<sup>b)</sup> Sony DVD recorders are operated with a DVD1 or DVD3 setting. For details, refer to the operating instructions supplied with the DVD recorders.

<sup>c)</sup> For details on the BD1 or BD3 setting, refer to operating instructions supplied with the Blu-ray disc player or Blu-ray disc recorder.

## To clear all remote button assignments

Press I/⏪, AUTO CAL and MASTER VOL – at the same time.

The remote is reset to its factory settings.

## Additional Information

### Glossary

#### ■ Dolby Digital

Digital audio encoding/decoding technology developed by Dolby Laboratories, Inc. It consists of front (Left/Right), center, surround (L/R) and sub-woofer channels. It is a designated audio standard for DVD-video and also known as 5.1 channel surround. Since surround information is recorded and reproduced in stereo, more realistic sound with fuller presence is delivered than with Dolby surround.

#### ■ Dolby Pro Logic II

This technology converts 2 channel stereo recorded audio into 5.1 channel for playback. There is a MOVIE mode for movies and MUSIC mode for stereo sources such as music. Old movies encoded in the traditional stereo format can be enhanced with 5.1 channel surround sound.

#### ■ Dolby Surround (Dolby Pro Logic)

Audio processing technology developed by Dolby Laboratories, Inc. Center and mono surround information is matrixed into two stereo channels. When reproduced, audio is decoded and output in 4 channel surround sound. This is the most common audio processing method for DVD-video.

#### ■ DTS Digital Surround

Digital audio encoding/decoding technology for theaters developed by DTS, Inc. It compresses audio less than Dolby Digital, delivering a higher quality sound reproduction.

## ■ HDMI (High-Definition Multimedia Interface)

HDMI is an interface that supports both video and audio on a single digital connection. The HDMI connection carries standard to high definition video signals and multi-channel audio signals to audio/video components, such as HDMI equipped TVs, in digital form without degradation. The HDMI specification supports HDCP (High-bandwidth Digital Contents Protection), a copy protection technology that incorporates coding technology for digital video signals.

## ■ Sampling frequency

To convert analog audio to digital, analog data should be quantified. This process is called sampling, and the number of times per second the analog data is quantified is called the sampling frequency. A standard music CD stores data quantified at 44,100 times per second, which is expressed as a sampling frequency of 44.1 kHz. Generally speaking, a higher sampling frequency means better sound quality.

# Precautions

## On safety

Should any solid object or liquid fall into the cabinet, unplug the receiver and have it checked by qualified personnel before operating it any further.

## On power sources

- Before operating the receiver, check that the operating voltage is identical with your local power supply.  
The operating voltage is indicated on the nameplate on the back of the receiver.
- The unit is not disconnected from the AC power source (mains) as long as it is connected to the wall outlet, even if the unit itself has been turned off.
- If you are not going to use the receiver for a long time, be sure to disconnect the receiver from the wall outlet. To disconnect the AC power cord, grasp the plug itself; never pull the cord.
- The AC power cord must be changed only at a qualified service shop.

## On heat buildup

Although the receiver heats up during operation, this is not a malfunction. If you continuously use this receiver at a large volume, the cabinet temperature of the top, side and bottom rises considerably. To avoid burning yourself, do not touch the cabinet.



## On placement

- Place the receiver in a location with adequate ventilation to prevent heat buildup and prolong the life of the receiver.
- Do not place the receiver near heat sources, or in a place subject to direct sunlight, excessive dust, or mechanical shock.
- Do not place anything on top of the cabinet that might block the ventilation holes and cause malfunctions.
- Do not place the receiver near equipment such as a television, VCR, or tape deck. (If the receiver is being used in combination with a television, VCR, or tape deck, and is placed too close to that equipment, noise may result, and picture quality may suffer. This is especially likely when using an indoor antenna. Therefore, we recommend using an outdoor antenna.)
- Use caution when placing the receiver or speakers on surfaces that have been specially treated (with wax, oil, polish, etc.) as staining or discoloration of the surface may result.

## On operation

Before connecting other components, be sure to turn off and unplug the receiver.

## If you encounter color irregularity on a nearby TV screen

The front and center speakers and the sub woofer are magnetically shielded to allow it to be installed near a TV set. However, color irregularities may still be observed on certain types of TV sets. As the surround speakers are not magnetically shielded, we recommend that you place the surround speakers slightly further away from TV set (page 12).

## If color irregularity is observed...

Turn off the TV set, then turn it on again after 15 to 30 minutes.

## If color irregularity is observed again...

Place the speaker further away from the TV set.

## If howling occurs

Reposition the speakers or turn down the volume on the receiver.

## On cleaning

Clean the cabinet, panel, and controls with a soft cloth slightly moistened with a mild detergent solution. Do not use any type of abrasive pad, scouring powder, or solvent, such as alcohol or benzene.

If you have any questions or problems concerning your receiver, please consult your nearest Sony dealer.

---

# Troubleshooting

If you experience any of the following difficulties while using the receiver, use this troubleshooting guide to help you remedy the problem.

## Audio

---

### **There is no sound, no matter which component is selected, or only a very low-level sound is heard.**

- Check that the speakers and components are connected correctly and securely.
- Check that both the receiver and all components are turned on.
- Check that MASTER VOLUME is not set to “VOL MIN”.
- Check that the headphone is not connected.
- Press MUTING to cancel the muting function.
- Check that you have selected the correct component with the input buttons.
- The protective device on the receiver has been activated. Turn off the receiver, eliminate the short-circuit problem, and turn on the power again.

---

### **There is no sound from a specific component.**

- Check that the component is connected correctly to the audio input jacks for that component.
- Check that the cord(s) used for the connection is (are) fully inserted into the jacks on both the receiver and the component.
- Check that you have selected the correct component on the receiver.

---

### **There is no sound from one of the front speakers.**

- Connect a pair of headphones to the PHONES jack to verify that sound is output from the headphones. If only one channel is output from the headphones, the component may not be connected to the receiver correctly. Check that all the cords are fully inserted into the jacks on both the receiver and the component. If both channels are output from the headphones, the front speaker may not be connected to the receiver correctly. Check the connection of the front speaker which is not outputting any sound.
- Make sure you have connected to both the L and R jacks of an analog component, and not only to either the L or R jack. Use an audio cord (not supplied).

---

### **The left and right sounds are unbalanced or reversed.**

- Check that the speakers and components are connected correctly and securely.
- Adjust the balance parameters using the LEVEL menu.

---

### **There is severe hum or noise.**

- Check that the speakers and components are connected securely.
- Check that the connecting cords are away from a transformer or motor, and at least 3 meters away from a TV set or fluorescent light.
- Move your TV away from the audio components.
- The plugs and jacks are dirty. Wipe them with a cloth slightly moistened with alcohol.

---

**There is severe hum, interrupted noise or distortion from component connected to the VIDEO 1 IN/ PORTABLE AUDIO IN/AUTO CAL MIC jack on the front panel of this receiver.**

- Check that the components are connected securely.
- Check that the cord used for the connection is fully inserted into the jacks on both the receiver and the component.
- This is not a malfunction and will depend on the connected component.

---

**There is no sound, or only a very low-level sound is heard from the center/ surround speakers.**

- Select a CINEMA STUDIO EX mode (page 44).
- Adjust the speaker level (page 27).

---

**There is no sound from the sub woofer.**

- Check that the sub woofer is connected correctly and securely.

---

**There is no sound from the speakers of the receiver when you connect the receiver and the playback component via a HDMI connection.**

- Make sure that you have connected the digital audio jacks on the playback component to the receiver. Then, turn off or mute the TV's volume.

---

**The surround effect cannot be obtained.**

- Make sure the sound field function is on (press MOVIE, or MUSIC).
- Sound fields do not function for signals with a sampling frequency of more than 48 kHz.

---

**Dolby Digital or DTS Multi Channel sound is not reproduced.**

- Check that the DVD, etc. you are playing is recorded in Dolby Digital or DTS format.
- When connecting the DVD player, etc. to the digital input jacks of this receiver, check the audio setting (settings for the audio output) of the connected component.

---

## Video

---

**There is no picture on the TV screen or monitor.**

- Make sure you have connected the video output of your video component to the TV.

---

**The source image input to the HDMI jack on the receiver is not output from the TV.**

- Check the HDMI connection.
- Depending on the playback component, you may need to set up the component. Refer to the operating instructions supplied with each component.

## Tuner

### The FM reception is poor.

- Use a 75-ohm coaxial cable (not supplied) to connect the receiver to an outdoor FM antenna as shown below. If you connect the receiver to an outdoor antenna, ground it against lightning. To prevent a gas explosion, do not connect the ground wire to a gas pipe.

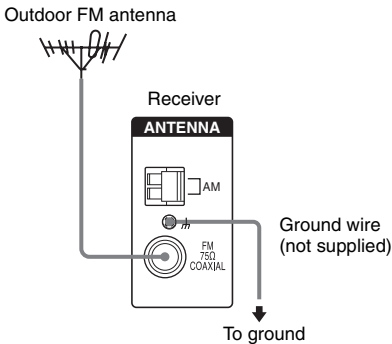

### Radio stations cannot be tuned in.

- Check that the antennas are connected securely. Adjust the antennas and connect an external antenna, if necessary.
- The signal strength of the stations is too weak (when tuning in with automatic tuning). Use direct tuning.
- Make sure you set the tuning interval correctly (when tuning in AM stations with direct tuning).
- No stations have been preset or the preset stations have been cleared (when tuning by scanning preset stations). Preset the stations (page 49).
- Press DISPLAY repeatedly on the receiver so that the frequency appears on the display.

### RDS does not work.\*

- Make sure that you are tuned to an FM RDS station.
- Select a stronger FM station.

### The RDS information that you want does not appear.\*

- Contact the radio station and find out whether they actually provide the service in question. If so, the service may be temporarily out of order.

\* Models of area code CEL, CEK only.

## Remote control

### The remote does not function.

- Point the remote at the remote sensor on the receiver.
- Remove any obstacles in the path between the remote and the receiver.
- Replace all the batteries in the remote with new ones, if they are weak.
- Make sure you select the correct input on the remote.
- The VIDEO 3 button on the remote is not available for receiver operation.

## Error messages

If there is a malfunction, the display shows a message. You can check the condition of the system by the message. Refer to the following table to solve the problem. If any problem persists, consult your nearest Sony dealer. If an error message appears while you perform Auto Calibration, see “Error and warning codes” (page 26) to solve the problem.

---

### DEC. EROR

Appears when a signal the receiver cannot decode (ex. DTS-CD) is input and “DEC. PRI.” on the AUDIO menu is set to “DEC. PCM”. Set it to “DEC. AUTO” (page 34).

---

### PROTECT

Irregular current is output from the speakers. The receiver will automatically turn off after a few seconds. Check the speaker connection and turn on the power again.

---

## If you are unable to remedy the problem using the troubleshooting guide

Clearing the receiver’s memory may remedy the problem (page 23). However, note that all memorized settings will be reset to their factory settings and you will have to readjust all settings on the receiver.

## If the problem persist

Consult your nearest Sony dealer. Note that if service personnel changes some parts during repair, these parts may be retained.

## Reference sections for clearing the receiver’s memory

To clear	See
All memorized settings	page 23
Customized sound fields	page 46

---

## Specifications

### Amplifier section

Models of area code CEL, CEK

Power Output<sup>1)</sup>

Stereo mode (rated) (6 ohms 1 kHz, THD 1%)  
85 W + 85 W

Surround mode<sup>2)</sup> (reference)  
(6 ohms 1 kHz, THD 10%)

RMS output

FRONT: 133 W

per channel

CENTER: 133 W

SURROUND: 133 W

per channel

Surround mode<sup>2)</sup> (reference)  
(6 ohms 100 Hz, THD 10%)

SUB WOOFER: 135 W

<sup>1)</sup>Measured under the following conditions:

Area code	Power requirements
CEL, CEK	230 V AC, 50 Hz

<sup>2)</sup>Reference power output for front, center, surround speakers and sub woofer. Depending on the sound field settings and the source, there may be no sound output.

Inputs

Analog                      Sensitivity: 800 mV/  
50 kohms

Digital (Coaxial)      Impedance: 75 ohms

Tone

Gain levels                ±6 dB, 1 dB step

Reproduction frequency range:

28 – 20,000 Hz

### FM tuner section

Tuning range              87.5 - 108.0 MHz

Antenna                    FM wire antenna

Antenna terminals      75 ohms, unbalanced

Intermediate frequency

10.7 MHz

## AM tuner section

Tuning range

Models of area code CEL, CEK

With 9-kHz tuning scale:

531 – 1,602 kHz

Antenna Loop antenna

Intermediate frequency

450 kHz

## General

Power requirements

Area code	Power requirements
CEL, CEK	230 V AC, 50/60 Hz

Power consumption

Area code	Power consumption
CEL, CEK	220 W

Power consumption (during standby mode)

0.3 W

Dimensions (w/h/d) (Approx.)

429 × 145 × 308 mm  
including projecting parts  
and controls

Mass (Approx.)

7.4 kg

## Speaker section

• **Front speakers (SS-MSP700)**

• **Center speaker (SS-CNP700)**

• **Surround speakers (SS-SRP700)**

Front/center speakers

Full range, magnetically  
shielded

Surround speakers Full range

Speaker units 70 mm cone type

Enclosure type Close type

Rated Impedance 6 ohms

Dimension (w/h/d) (Approx.)

Front/surround speakers

92 × 98.5 × 101.5 mm

Center speaker 152 × 98.5 × 101.5 mm

Mass (Approx.)

Front speakers 0.6 kg

Center speaker 0.7 kg

Surround speakers 0.5 kg

• **Sub woofer (SS-WP700)**

Speaker system Magnetically shielded

Speaker unit 200 mm cone type

Enclosure type Bass reflex

Rated Impedance 6 ohms

Dimensions (w/h/d) (Approx.)

270 × 330 × 303 mm  
including front panel

Mass (Approx.)

4.7 kg

## Supplied accessories

FM wire antenna (1)

AM loop antenna (1)

Coaxial digital cord (1)

Speaker cords (long) (2)

Speaker cords (short) (3)

Foot pads (speakers) (20)

Foot pads (sub woofer) (4)

Remote commander RM-AAU013 (1)

R6 (size-AA) batteries (2)

Optimizer microphone (ECM-AC2 or  
ECM-AC2a) (1)

Speakers

- Front speakers (2)
- Center speaker (1)
- Surround speakers (2)
- Sub woofer (1)

For details on the area code of the component you are using, see page 3.
--

Design and specifications are subject to change without notice.

# Index

## Numerics

2 channel 46  
2CH STEREO 46  
5.1 channel 12

## A

AUTO CALIBRATION 24  
AUTO FORMAT DIRECT  
(A.F.D.) 41

## B

Blu-ray disc player  
connecting 18

## C

CD player  
connecting 16

## D

Digital Cinema Sound  
(DCS) 44, 45  
Dolby Digital 55  
DTS 55  
DVD player  
connecting 20  
playback 31

## E

Error messages 61

## H

HDMI  
connecting 18

## I

Initial setup 23

## M

Menu  
A. CAL 40  
AUDIO 37  
LEVEL 35  
SUR 36  
SYSTEM 38  
TONE 36  
TUNER 37  
Muting 29

## N

Naming 50, 53

## P

Portable audio 16

## R

RDS 51

## S

Satellite tuner  
connecting 20  
Selecting  
component 29  
sound field 43  
Set-top box  
connecting 20  
Sleep Timer 54  
Sound fields  
resetting 46  
selecting 43  
Speakers  
connecting 14  
installing 12  
Super Audio CD player  
connecting 16  
Supplied accessories 63

## T

TEST TONE 27  
Tuner  
connecting 22  
Tuning  
automatically 47  
directly 48  
to preset stations 50  
TV  
connecting 20



\* 2 8 9 8 4 2 6 7 1 \* (1)