

Trinitron Color TV

Operating Instructions _____

GB

- Before operating the unit, please read this manual thoroughly and retain it for future reference.

WEGA

KV-DZ29









A Specifications

	KV-DZ29M80 KV-DZ29M50	Note
Power requirements	110-240 V AC, 50/60 Hz	
Power consumption (W)	Indicated on the rear of the TV	
Television system	B/G, I, D/K, M	
Color system	PAL, PAL 60, SECAM, NTSC3.58, NTSC4.43	
Channel coverage		
B/G	VHF : E2 to E12 /UHF : E21 to E69 / CATV : S01 to S03, S1 to S41	
I	UHF : B21 to B68 /CATV : S01 to S03, S1 to S41	
D/K	VHF : C1 to C12, R1 to R12 / UHF : C13 to C57, R21 to R60 / CATV : S01 to S03, S1 to S41, Z1 to Z39	
M	VHF : A2 to A13 /UHF : A14 to A79 / CATV : A-8 to A-2, A to W+4, W+6 to W+84	
⌚ (Antenna)	75-ohm external terminal	
Audio output (Speaker)	10 W + 10 W	
Number of terminal		
📺 (Video)	Input: 3 Output: 1 Phono jacks; 1 Vp-p, 75 ohms	
🎧 (Audio)	Input: 5 Output: 1 Phono jacks; 500 mVrms	
📺 (S Video)	Input: 1 Y: 1 Vp-p, 75 ohms, unbalanced, sync negative C: 0.286 Vp-p, 75 ohms	
📺 (Component Video)	Input: 2 Phono jacks; Y: 1 Vp-p, 75 ohms, sync negative P _B /C _B : 0.7 Vp-p, 75 ohms P _R /C _R : 0.7 Vp-p, 75 ohms	
🎧 (Headphone)	Output: 1 Stereo minijack	
Picture tube	29 in.	
Tube size (cm)	72	Measured diagonally
Screen size (cm)	68	Measured diagonally
Dimensions (w/h/d, mm)	794 × 590 × 507	
Mass (kg)	47	

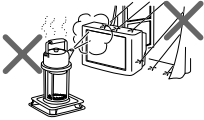
Design and specifications are subject to change without notice.

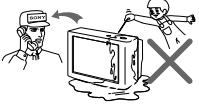
B WARNING

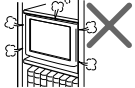
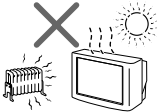
- Dangerously high voltages are present inside the TV.
- TV operating voltage: 110 – 240 V AC.
- Do not plug in the power cord until you have completed making all other connections; otherwise a minimum leakage current might flow through the antenna and other terminals to ground.
- To avoid battery leakage and damage to the remote, remove the batteries from the remote if you are not going to use it for several days. If any liquid leaks from the batteries and touches your skin, immediately wash it away with water.

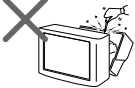
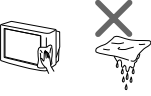
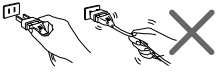
 <p>For your own safety, do not touch any part of the TV, the power cord and the antenna cable during lightning storms.</p>	 <p>For children's safety, do not leave children alone with the TV. Do not allow children to climb onto it.</p>	 <p>To prevent fire or shock hazard, do not expose the TV to rain or moisture.</p>
 <p>Do not place any objects on the TV. The apparatus shall not be exposed to dripping or splashing and that no objects filled with liquids, such as vases, shall be placed on the apparatus.</p>	 <p>Do not operate the TV if any liquid or solid object falls into it. Have it checked immediately by qualified personnel only.</p>	 <p>Install the TV on a stable TV stand and floor which can support the TV set weight. Ensure that the TV stand surface is flat and its area is larger than the bottom area of the TV.</p>
 <p>Do not block the ventilation openings of the TV. Do not install the TV in a confined space, such as a bookcase or built-in cabinet.</p>	 <p>Your TV is recommended for home use only. Do not use the TV in any vehicle or where it may be subject to excessive dust, heat, moisture or vibrations.</p>	 <p>Do not plug in too many appliances to the same power socket. Do not damage the power cord.</p>
 <p>Do not open the cabinet and the rear cover of the TV as high voltages and other hazards are present inside the TV. Refer servicing and disposal of the TV to qualified personnel.</p>	 <p>Clean the TV with a dry and soft cloth. Do not use benzine, thinner, or any other chemicals to clean the TV. Do not attach anything (e.g., adhesive tape, cellophane tape, glue) on the painted cabinet of the TV. Do not scratch the picture tube.</p>	 <p>Pull the power cord out by the plug. Do not pull the power cord itself. Even if your TV is turned off, it is still connected to the AC power source (mains) as long as the power cord is plugged in. Unplug the TV before moving it or if you are not going to use it for several days.</p>

C Securing the TV

To prevent the TV from falling, use the supplied screws, clamps and band to secure the TV.

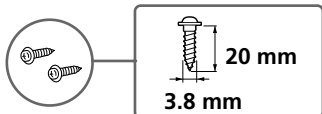

screws



clamps



band

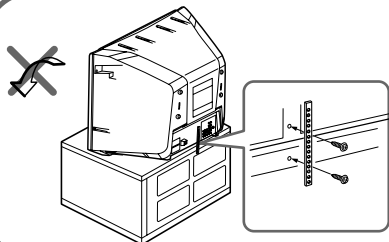

Screw the band to the TV stand and to the provided hole at the rear of your TV.

or

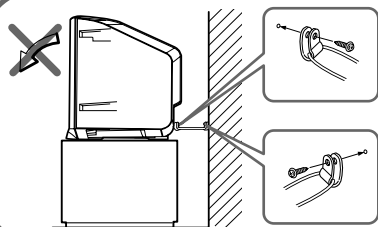

- (1) Put a cord or chain through the clamps.
- (2) Screw one clamp to a wall or pillar and the other clamp to the provided hole at the rear of your TV.

or

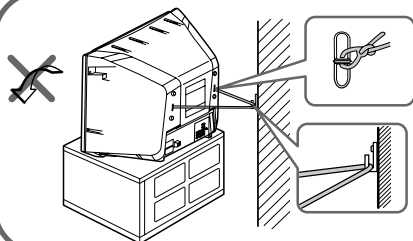

- (1) Attach each end of a cord or chain to the provided holders at the rear of your TV.
- (2) Securely fix the attached cord or chain to a wall or pillar using an attachment which can support the TV set weight.

 Use only the supplied screws. Use of other screws may damage the TV.

D Getting Started

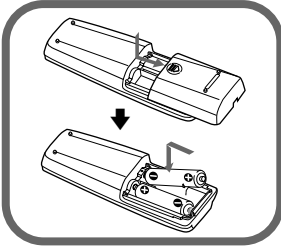

Step 1

Insert the batteries (supplied) into the remote.

: • Do not use old or different types of batteries together.

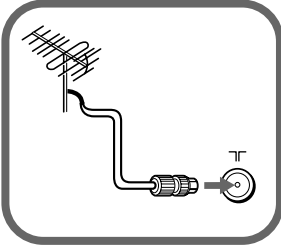

Step 2

Connect the antenna cable (not supplied) to (antenna input) at the rear of the TV.

: • You can also connect the TV to other optional components (see).

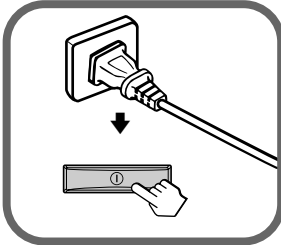

Step 3

Plug in the power cord, then press on the TV to turn it on.

: • The (standby) indicator flashes green for a few seconds when turning on the TV. This does not indicate a malfunction.



Step 4

Set up the TV by following the instructions of the "Initial Setup" menu (see).

📺 Setting up your TV (“Initial Setup”)

When you turn on your TV for the first time, the “Initial Setup” menu will appear. You can adjust settings below using the buttons on the remote control or TV front panel. Press **↑**, **↓**, **←** or **→** to select or adjust items, then press **↵**.

- 1** Select the desired menu language.

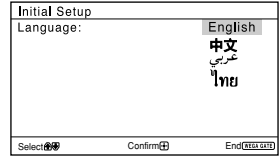

- 2** Select “Yes” to preset the channels automatically.
To skip automatic channel presetting, select “No”.

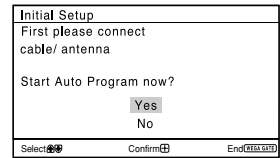

- 3** The “Program Sorting/Edit” menu enables you to sort and edit the channels (see **N**).

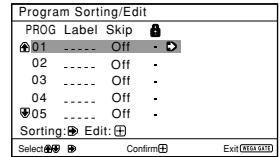

- 4** Adjust the bars on the top and bottom of the menu if they are slanted.

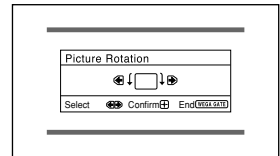

- 5** Adjust the upper and lower bars if they are not equally positioned to the top and bottom of the screen.

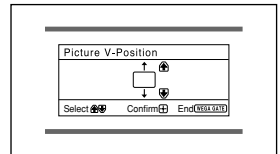

- 6** To prevent this “Initial Setup” menu from appearing again when you turn on the TV by pressing **⓪**, select “No”.

To allow this menu to appear again, select “Yes”.

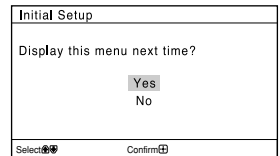

- 🔧:**
- You can immediately go to the end of the “Initial Setup” menu by pressing WEGA GATE.
 - Before adjusting “Picture Rotation” and “Picture V-Position”, keep electrical equipment (external speakers) away from the TV to avoid magnetic disturbance.

F Connecting optional components

You can connect a wide range of optional components to your TV. Connecting cables are not supplied.

Connecting to the TV (front)

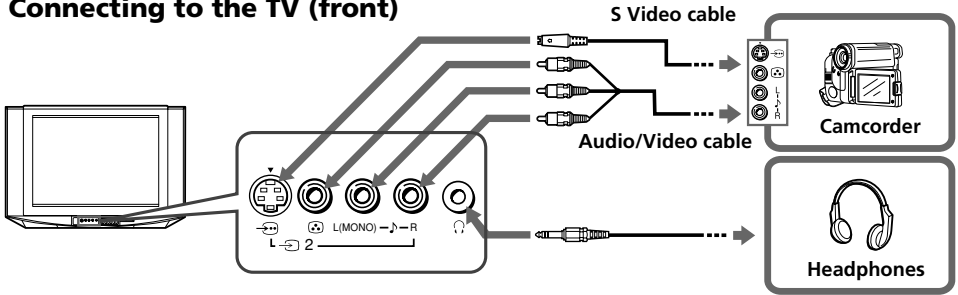

Connecting to the TV (rear)

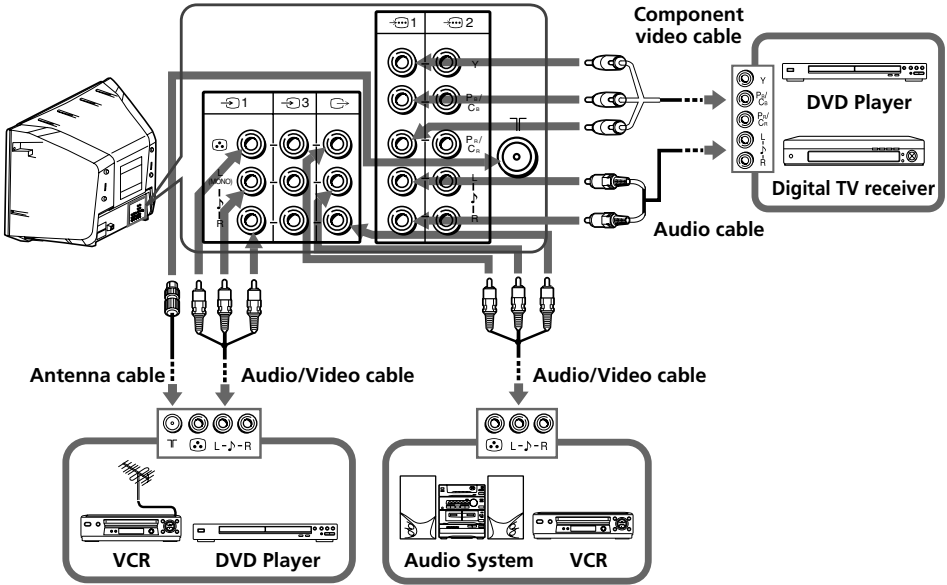

- If you connect a VCR to T (antenna input), preset the signal output from the VCR to the program number 0 on the TV (see **N**).
- When both S (S video) and (video) for 2 are connected at the same time, S (S video) is automatically selected. To view (video), disconnect the S video cable.
- The component video terminals on your DVD player are sometimes labeled Y/Cb/Cr, Y/Pb/Pr, Y/Cb/Cr or Y/B-Y/R-Y.
- If you select "HD/DVD 1" or "HD/DVD 2" on your TV screen, the signal from the (monitor output) terminals will not be output properly. This does not indicate a malfunction.
- The TV accepts the following signal formats:

Total scanning line	1125i	750p	625p	625i	525p	525i
Effective scanning line	1080i	720p	576p	576i	480p	480i
fV (Hz)	50/60	50/60	50	50	60	60

G Troubleshooting

If you find any problem while viewing your TV, you can either use the “Factory Settings” function (see **Q**) or check the Troubleshooting guide below. If the problem persists, contact your Sony dealer.

Snowy picture, noisy sound

- Check the antenna setup and other connections.
- Preset the channel manually again (see **N**).
- Set the “Signal Booster” to “Auto” (see **N**) or try using an external booster.

Distorted picture, noisy sound

- Set the “Signal Booster” to “Off” (see **N**), or turn off or disconnect any external booster in use.

Good picture, noisy sound

- Select the appropriate “TV System” (see **N**).

No picture, no sound

- Check the power cord, antenna setup and other connections.
- Press **I/⏻** (power) to turn on the TV.
- Press **Ⓛ** (main power) on the TV to turn off the TV for about five seconds, then turn it on again.

Good picture, no sound

- Press **⏮** + to increase the volume level or press **⏸** to cancel the muting.

Dotted lines or stripes

- Do not use a hair dryer or other equipment near the TV.
- Check the antenna setup.

Double images or “ghosts”

- Use the fine tuning (“Fine”) function (see **N**).
- Check the antenna setup or use a highly directional antenna.
- Turn off or disconnect any external booster in use.

No color

- Adjust the “Color” level from “Picture Adjustment” (see **K**).
- Select the appropriate “Color System” (see **Q**).
- Check the antenna setup.

Picture slant

- Keep external speakers or other electrical equipment away from the TV. The magnetic disturbance from these equipments or the direction of the earth’s magnetic field may affect the TV.
- Adjust the “Picture Rotation” or “Picture V-Position” (see **Q**).

Abnormal color patches

- Keep external speakers or other equipment away from the TV. Do not move the TV while the TV is turned on. Press **Ⓛ** (main power) on the TV to turn off the TV for about 15 minutes, then turn it on again to demagnetize the TV.

Troubleshooting (continued)

The ⏻ (standby) indicator on your TV flashes red several times after every three seconds.

- Count the number of times the ⏻ (standby) indicator flashes. Press ⏻ (main power) to turn off your TV. Contact your nearest Sony service center.

The TV screen sometimes goes blank for slightly longer than usual during channel change.

- The “Signal Booster” is functioning to detect a weak signal. This does not indicate a malfunction.

Cannot play shooting games.

- Some shooting games which involve pointing a light beam at the TV screen with an electronic gun or rifle cannot be used with your TV. For details, see the instruction manual supplied with the video game software.

TV cabinet creaks.

- Changes in room temperature sometimes make the TV cabinet expand or contract, causing a noise. This does not indicate a malfunction.

A small “boom” sound is heard when the TV is turned on.

- The TV’s demagnetizing function is working. This does not indicate a malfunction.

Horizontal thin lines appear on the TV screen.

- The visible lines that sometimes appear on your TV screen are shadows from the damper wires used to stabilize the aperture grille of the Trinitron picture tube. This does not indicate a malfunction.

H TV buttons and remote control

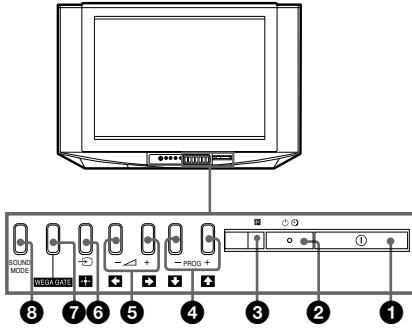

- 1 I/| Turn off or turn on the TV.
- 2 Wake Up indicator.
- 2 Standby indicator.
- 3 Remote control sensor.
- 4 PROG +/- Select program number.
- 5 Adjust volume.
- 6 Select TV or video input.

WEGA GATE menu operations (see 1)

- 4, 5 Select or adjust items.
- 6 Confirm selected items.
- 7 WEGA GATE Display or cancel WEGA GATE menu.
- 8 SOUND MODE Select sound mode options with a 5-Band Graphic Equalizer display (see L).

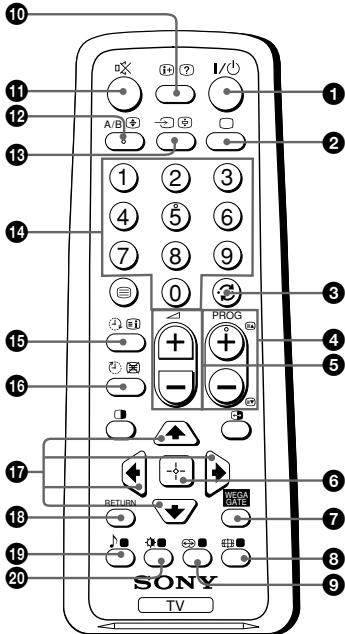

- 1 I/| Turn off temporarily or turn on the TV.
- 2 Display the TV program.
- 3 Jump to last program number that has been watched for at least five seconds.
- 4 PROG +/- Select program number. To select quickly, press and hold until the desired program number appears.
- 5 Adjust volume.
- 8 Change the picture size: "4:3", "16:9" (16:9 wide mode).
- 9 Select surround mode options (see L).
- 10 Display on-screen information.
- 11 Mute the sound.
- 12 A/B Not function for your TV.
- 13 Select TV or video input.
- 14 0 - 9 Input numbers. For program numbers 10 and above, enter the second digit within two seconds.

TV buttons and remote control (continued)

19 

Select sound mode options with a 5-Band Graphic Equalizer display: "Dynamic", "Standard", "Custom"* (see **L**).

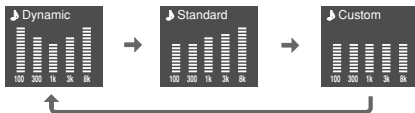



* When the "Custom" mode is selected, you can receive the last adjusted sound settings from the "Sound Adjustment" option in the menu.

20 



Select picture mode options: "Vivid", "Standard", "Custom"* (see **K**).

* When the "Custom" mode is selected, you can receive the last adjusted picture settings from the "Picture Adjustment" option in the menu.



WEGA GATE menu operations (see **I**)

- 6  Confirm selected items.
- 7 WEGA GATE Display or cancel WEGA GATE menu.
- 17  Select or adjust items.
- 18 RETURN Return to the previous level.

Timer operations

- 15  (Wake Up Timer) Set TV to turn on automatically according to the desired period of time (max. of 12 hours). The  indicator on TV lights up amber once you set the wake up timer. If no buttons or controls are pressed for more than one hour after the TV is turned on using the wake up timer, the TV automatically goes into standby mode.
- 16  (Sleep Timer) Set TV to turn off automatically according to the desired period of time (max. of one hour and 30 min.).

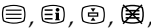
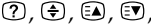
Teletext operations (green icon)

- , Not function for your TV.
- 
-  (red, green, yellow, blue)

PIP operations

-   Not function for your TV.

Manufactured under license from BBE Sound, Inc.

Licensed by BBE Sound, Inc. under one or more of the following US patents: 5510752, 5736897. BBE and BBE symbol are registered trademarks of BBE Sound, Inc.

WEGA GATE navigator

WEGA GATE is a gateway that allows you access to preset TV channels, connected external inputs and “Settings” menu.

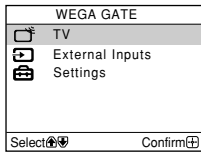

“TV”

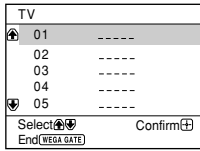

watch the preset TV channels (see **E**)

“External Inputs”

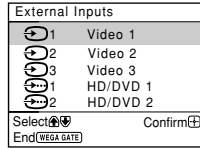

select the inputs for the connected equipment (see **F**)

“Settings”

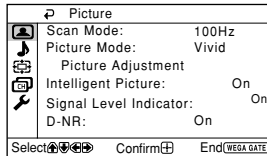

change the settings of your TV (see **J**)

How to use WEGA GATE

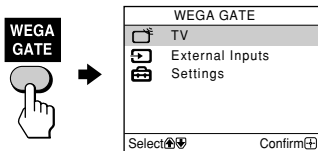

(1) Press WEGA GATE to display or cancel the WEGA GATE menu.

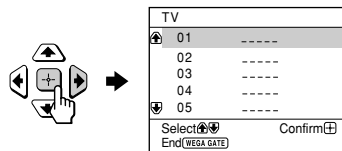

(2) Press **WEGA GATE** (or **→**) to confirm your selection or go to the next level.

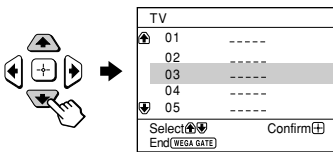

(3) Press **↑** or **↓** to select the desired item.

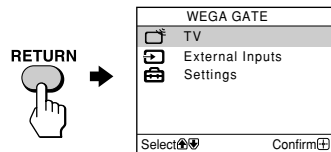

(4) Press **RETURN** to move to the previous level.

: • When a feature is dimmed in the menu, it is not selectable.

• The WEGA GATE, **+** and **↑, ↓, ←, →** buttons on the front panel can also be used for the operations above.

J "Settings" Adjustment

You are able to change the settings of your TV from "Settings" in WEGA GATE menu (see **I**). The following is an overview of the items that can be adjusted.

Picture	
Scan Mode:	100Hz
Picture Mode:	Vivid
Picture Adjustment	
Intelligent Picture:	On
Signal Level Indicator:	On
D-NR:	On

"Picture" (see **K**)

"Scan Mode": "100Hz" → "Progressive"

"Picture Mode": "Vivid" → "Standard" → "Custom"

"Picture Adjustment": "Picture", "Brightness", "Color", "Hue", "Sharpness", "Color Temperature", "VM", "Reset"

"Intelligent Picture": "On" → "Off"

"Signal Level Indicator": "On" → "Off"

"D-NR": "On" → "Off"

Sound	
Sound Mode:	Dynamic
Sound Adjustment	
Balance	
Intelligent Volume:	Off
Surround:	Off

"Sound" (see **L**)

"Sound Mode": "Dynamic" → "Standard" → "Custom"

"Sound Adjustment": "Adjust", "Reset"

"Balance"

"Intelligent Volume": "On" → "Off"

"Surround": "Movie" → "Sports" → "Off"

Wide Screen	
Wide Mode:	4:3
Auto Wide:	On

"Wide Screen" (see **M**)

"Wide Mode": "16:9" → "4:3"

"Auto Wide": "On" → "Off"

Channel Setup	
Auto Program	
Manual Program	
Program Sorting/Edit	

"Channel Setup" (see **N**)

"Auto Program"

"Manual Program"

"Program": "00" - "99"

"TV System": "B/G" → "I" → "D/K" → "M"

"VHF Low" / "VHF High" / "UHF"

"Fine": "Auto" → "Manual"

"Signal Booster": "Auto" → "Off"

"Program Sorting/Edit"

Setup	
Language:	English
Picture Position	
Game Mode:	Off
Video Label	
Color System:	Auto
Eco Mode:	Off

"Setup" (see **O**)

"Language": "English" → "中文" (Chinese) → "عربي" (Arabic) → "ไทย" (Thai)

"Picture Position": "Picture Rotation", "Picture V-Position"

"Game Mode": "On" → "Off"

"Video Label"

"Color System": "Auto" → "PAL" → "SECAM" → "NTSC3.58" → "NTSC4.43"

"Eco Mode": "On" → "Off"

"Factory Settings": "Yes" → "No"

K "Picture" setting

Press WEGA GATE and select "Settings".
Make sure the "Picture" icon (🖥️) is selected, then press (⏏).

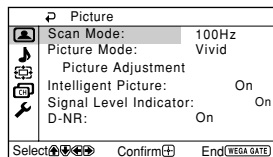

"Scan Mode" Choose either "100Hz" (reduce flicker on the screen to provide a stable picture) or "Progressive" (reduce jitter of any small areas or scanning lines on the screen).

"Picture Mode" Choose either "Vivid" (bright, contrast and sharp), "Standard" (normal) or "Custom".

"Intelligent Picture" Optimize picture quality.
Press ⬆ or ⬇ to select "On", then press (⏏).
To cancel, select "Off", then press (⏏).

"Signal Level Indicator" Display the signal level when the "Intelligent Picture" is functioning.
"Intelligent Picture Signal Level" indicator will be displayed, followed by picture improvement when you change the program number or the input mode.



red amber green
(weak) (average) (good)

Press ⬆ or ⬇ to select "On", then press (⏏).
To cancel, select "Off", then press (⏏). "Intelligent Picture" is still functioning.

"D-NR" (Digital Noise Reduction) Reduce noise level automatically to get optimum picture.
Press ⬆ or ⬇ to select "On", then press (⏏).
To cancel, select "Off", then press (⏏).

* You can adjust the setting to your personal preference in the "Picture Adjustment" option only when the "Custom" mode is selected.

- 📌:
- "Scan Mode" is not selectable when "Game Mode" is turned to "On". "Scan Mode" is not available for HD (high-definition) and progressive input signals.
 - "D-NR" is not available in HD and progressive input signals.
 - "Signal Level Indicator" does not function in "HD/DVD 1" and "HD/DVD 2" input modes.

“Picture” setting (continued)

Adjusting the “Picture Adjustment” items under “Custom” mode

- 1** Press **↑** or **↓** to select either “Picture” (contrast), “Brightness”, “Color”, “Hue” (color tones), “Sharpness”, “Color Temperature” (choose either “Cool”, “Neutral” or “Warm”) or “VM” (choose either “High”, “Low” or “Off”), then press **↵**.

Selecting “Reset” will set your TV to the factory settings.

- 2** Press **↑, ↓, ←** or **→** to adjust the setting of your selected item, then press **↵**.
-

- 3** Repeat the above steps to adjust other items.

The adjusted settings will be received when you select “Custom”.

- ℹ**: • “Hue” can be adjusted for the NTSC color system only.
• Reducing “Sharpness” can also reduce picture noise.

L “Sound” setting

Press WEGA GATE and select “Settings”.
Press \uparrow or \downarrow to select the “Sound”
icon (🔊), then press $\left[\begin{smallmatrix} \uparrow \\ \downarrow \end{smallmatrix} \right]$.

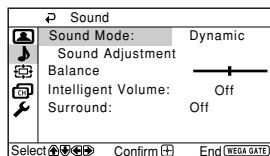

“Sound Mode”	Choose either “Dynamic” (low and high tones), “Standard” (voice and high tones) or “Custom”*.
“Balance”	Press \downarrow or \leftarrow to emphasize the left speaker. Press \uparrow or \rightarrow to emphasize the right speaker.
“Intelligent Volume”	Adjust the volume of all program numbers and video inputs automatically. Press \uparrow or \downarrow to select “On”, then press $\left[\begin{smallmatrix} \uparrow \\ \downarrow \end{smallmatrix} \right]$. To cancel, select “Off”, then press $\left[\begin{smallmatrix} \uparrow \\ \downarrow \end{smallmatrix} \right]$.
“Surround”	Choose either “Movie” (cinema surround effect for stereo sound), “Sports” (simulated stadium effect for monaural sound) or “Off”.

* You can adjust the setting to your personal preference in the “Sound Adjustment” option only when the “Custom” mode is selected.

Adjusting the “Sound Adjustment” items under “Custom” mode

The 5-Band Graphic Equalizer feature allows you to adjust sound frequency settings of “Custom” mode in the menu.

1 Make sure that “Adjust” is selected, then press $\left[\begin{smallmatrix} \uparrow \\ \downarrow \end{smallmatrix} \right]$.



Selecting “Reset” will set your TV to the factory settings.

2 Press \leftarrow or \rightarrow to select the desired sound frequency, then press \uparrow or \downarrow to adjust the setting and press $\left[\begin{smallmatrix} \uparrow \\ \downarrow \end{smallmatrix} \right]$.

The adjusted settings will be received when you select “Custom”.

- 🔊:
- Adjusting higher frequency will affect higher pitched sound and adjusting lower frequency will affect lower pitched sound.
 - You may display the settings directly by using the SOUND MODE button on the TV front panel (see **H**) or **J** button on the remote control (see **H**).

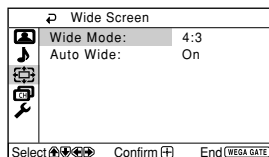

M "Wide Screen" setting

Press WEGA GATE and select "Settings".
Press \uparrow or \downarrow to select the "Wide Screen"
icon (), then press ().



"Wide Mode" Change the size of the picture when receiving wide-mode (16:9) picture signal.
Choose "16:9".
To restore the normal picture size, select "4:3", then press ().

"Auto Wide" Display the picture in optimum wide screen automatically when you choose "On".
To cancel, select "Off", then press ().

- :
- You can also change to wide-mode picture size by pressing the () button on the remote control (see ).
 - "Wide Mode" is not selectable for HD (1080i, 720p) input signals. For HD (1080i, 720p) input signals, your TV will always display wide mode picture.
 - "Auto Wide" is only available when receiving 576i, 480p and 480i input signals.



N "Channel Setup" setting

Press WEGA GATE and select "Settings".

Press \uparrow or \downarrow to select the "Channel Setup"

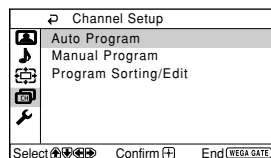
icon () , then press $\left[\begin{smallmatrix} \uparrow \\ \downarrow \end{smallmatrix} \right]$.







"Auto Program"	Preset channels automatically.
"Manual Program"	Manually preset desired channels and channels that cannot be preset automatically (see Presetting channels manually).
"Program Sorting/Edit"	<p>Sort and edit the channels.</p> <p>(a) If you wish to keep the channels in the current condition, press WEGA GATE to exit.</p> <p>(b) Press \uparrow or \downarrow to select the program number with the channel you wish to change. The selected channel will appear on the screen.</p> <p>(c) If you wish to store the channels in a different order:</p> <p>(1) Press \blacktriangleright to enter sorting mode.</p> <p>(2) Press \uparrow or \downarrow to select the new program number position for your selected channel, then press \blacktriangleleft.</p> <p>(d) If you wish to edit the channels, press $\left[\begin{smallmatrix} \uparrow \\ \downarrow \end{smallmatrix} \right]$ to change to edit mode.</p> <p>Press \blacktriangleright until the mode that you wish to edit is highlighted: Label, Skip,  (block symbol). Then press $\left[\begin{smallmatrix} \uparrow \\ \downarrow \end{smallmatrix} \right]$.</p> <p>(1) To label, press \uparrow or \downarrow to select the alphanumeric characters for the label. Then press $\left[\begin{smallmatrix} \uparrow \\ \downarrow \end{smallmatrix} \right]$.</p> <p>(2) To skip the program number, press \uparrow or \downarrow to select "On". Then press $\left[\begin{smallmatrix} \uparrow \\ \downarrow \end{smallmatrix} \right]$.</p> <p>You can skip this program number when using PROG +/-.</p> <p>(3) To block unwanted program number, press \uparrow or \downarrow to select . Then press $\left[\begin{smallmatrix} \uparrow \\ \downarrow \end{smallmatrix} \right]$.</p> <p>(e) Repeat step (b) to (d) if you wish to change other channels.</p> <p>Press WEGA GATE to exit.</p>

- :
- If you preset a blocked program number, that program number will be unblocked automatically.
 - If you sort a blocked program, that program will remain blocked.

“Channel Setup” setting (continued)



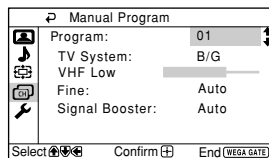

Presetting channels manually

1 After selecting “Manual Program”, select the program number to which you want to preset a channel.







- (1) Make sure “Program” is selected, then press .
- (2) Press  or  until the program number you want to preset appears on the menu, then press .













2 Select the desired channel.

- (1) Make sure either “VHF Low”, “VHF High” or “UHF” is selected, then press .
- (2) Press  or  until the desired channel’s broadcast appears on the TV screen, then press .

3 If the sound of the desired channel is abnormal, select the appropriate TV system.







- (1) Press  or  to select “TV System”, then press .
- (2) Press  or  until the sound becomes normal, then press .

4 If you are not satisfied with the picture and sound quality, you may be able to improve them by using the “Fine” tuning feature.





- (1) Press  or  to select “Fine”, then press .
- (2) Press  or  to select “Manual”, then press .
- (3) Press , ,  or  until the picture and sound quality are optimal, then press .











The + or – icon on the menu flashes while tuning.

































5 If the TV signal is too strong (picture distorted; picture with lines; signal interference) or weak (snowy picture), you may be able to improve the picture quality by setting the “Signal Booster” feature.

- (1) Press  or  to select “Signal Booster”, then press .
 - (2) Press  or  to select either “Off” (for picture distorted; picture with lines; signal interference) or “Auto” (for snowy picture), then press .
-





"Setup" setting





Press WEGA GATE and select "Settings".
Press  or  to select the "Setup"
icon () , then press .

P Setup	
	Language: English
	Picture Position
	Game Mode: Off
	Video Label
	Color System: Auto
	Eco Mode: Off
Select   Confirm  End 	

-
- "Language" Change the menu language.
Press  or  to select either "English", "中文" (Chinese), "عربي" (Arabic) or "ไทย" (Thai), then press .
-
- "Picture Position" Adjust the picture position when it is not aligned with the TV screen.
Press  or  to select "Picture Rotation" or "Picture V-Position", then press 
Press , ,  or  to adjust the picture position, then press .
-
- "Game Mode" Adjust the picture setting that is suitable to view video games.
Press  or  to select "On", then press 
To cancel, select "Off", then press .
-
- "Video Label" Label the connected equipment.
(1) Press  or  to select the input you want to label, then press 
(2) Press  or  to select the label options: "Video 1" / "Video 2" / "Video 3" / "HD/DVD 1" / "HD/DVD 2", "VCR", "SAT", "Game" or "Edit**", then press 
* You may edit the video label to your favorite name.
Press  or  to select alphanumeric characters for the label, then press .
-
- "Color System" Select the color system.
Press  or  to select either "Auto", "PAL", "SECAM", "NTSC3.58" or "NTSC4.43", then press . Normally, set this to "Auto".
-
- "Eco Mode" Reduce power consumption of your TV to save energy.
Press  or  to select "On", then press 
When you press  or turn on the TV, Eco Mode () symbol will appear on the screen for a while.
To cancel, select "Off", then press .
-

“Setup” setting (continued)

“Factory Settings”	Reset your TV to factory settings. Press  and press  or  to select “Yes”, then press  . Your TV will go blank for a few seconds, then the “Initial Setup” menu will appear. To cancel, select “No”, then press  .
--------------------	---

- :
- You cannot adjust “Picture Rotation” and “Picture V-Position” when HD (1080i, 720p) signals are input.
 - “Game Mode” is available only when receiving signals through the  (video input),  (S video input) or  (component video input) terminals.
 - When HD or progressive signals are input, “Game Mode” does not function.