

Trinitron Color TV

Operating Instructions _____

GB

- Before operating the unit, please read this manual thoroughly and retain it for future reference.

WEGA

KV-DB29

WARNING

- Dangerously high voltages are present inside the TV.
- TV operating voltage: 220 – 240 V AC.
- Do not plug in the power cord until you have completed making all other connections; otherwise a minimum leakage current might flow through the antenna and other terminals to ground.
- To avoid battery leakage and damage to the remote, remove the batteries from the remote if you are not going to use it for several days. If any liquid leaks from the batteries and touches your skin, immediately wash it away with water.







 <p>For your own safety, do not touch any part of the TV, the power cord and the antenna cable during lightning storms.</p>	 <p>For children's safety, do not leave children alone with the TV. Do not allow children to climb onto it.</p>	 <p>To prevent fire or shock hazard, do not expose the TV to rain or moisture.</p>
 <p>Do not place any objects on the TV. The apparatus shall not be exposed to dripping or splashing and that no objects filled with liquids, such as vases, shall be placed on the apparatus.</p>	 <p>Do not operate the TV if any liquid or solid object falls into it. Have it checked immediately by qualified personnel only.</p>	 <p>Install the TV on a stable TV stand and floor which can support the TV set weight. Ensure that the TV stand surface is flat and its area is larger than the bottom area of the TV.</p>
 <p>Do not block the ventilation openings of the TV. Do not install the TV in a confined space, such as a bookcase or built-in cabinet.</p>	 <p>Your TV is recommended for home use only. Do not use the TV in any vehicle or where it may be subject to excessive dust, heat, moisture or vibrations.</p>	 <p>Do not plug in too many appliances to the same power socket. Do not damage the power cord.</p>
 <p>Do not open the cabinet and the rear cover of the TV as high voltages and other hazards are present inside the TV. Refer servicing and disposal of the TV to qualified personnel.</p>	 <p>Clean the TV with a dry and soft cloth. Do not use benzine, thinner, or any other chemicals to clean the TV. Do not attach anything (e.g., adhesive tape, cellophane tape, glue) on the painted cabinet of the TV. Do not scratch the picture tube.</p>	 <p>Pull the power cord out by the plug. Do not pull the power cord itself. Even if your TV is turned off, it is still connected to the AC power source (mains) as long as the power cord is plugged in. Unplug the TV before moving it or if you are not going to use it for several days.</p>

Table of Contents

Installation

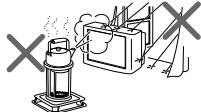
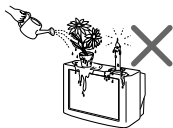
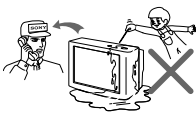
Securing the TV	4
Getting Started	5
Setting up your TV ("Initial Setup")	6

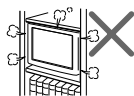
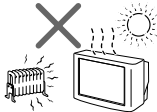
Overview of Controls

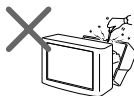
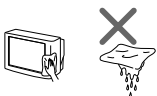
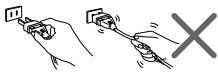
TV front and rear panels	8
Using the remote control and basic functions	9

Advanced Operations

Selecting the picture and sound modes	11
Enjoying the WEGA Theatre Mode	12
Enjoying stereo or bilingual programs	13
Operating optional components	14

Menu Adjustment

Introducing the WEGA GATE navigator	15
"Settings" Adjustment	16
Changing the "Picture" setting	18
Changing the "Sound" setting	20
Changing the "Wide Screen" setting	22
Changing the "Channel Setup" setting	23
Changing the "Setup" setting	25

GB

Additional Information

Connecting optional components ...	27
Troubleshooting	29
Specifications	31

■ Securing the TV

To prevent the TV from falling, use the supplied screws, clamps and band to secure the TV.

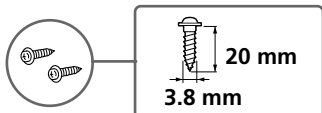

screws



clamps

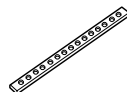

band

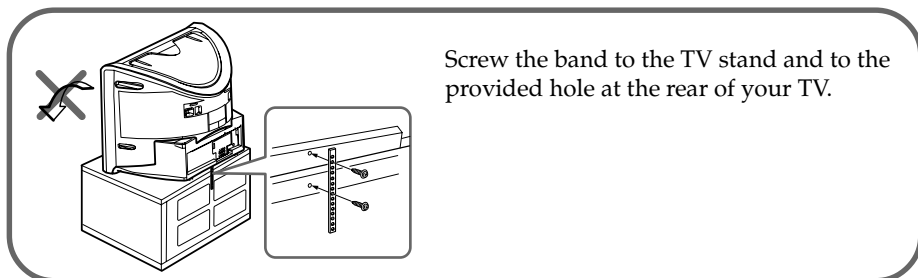

Screw the band to the TV stand and to the provided hole at the rear of your TV.

or

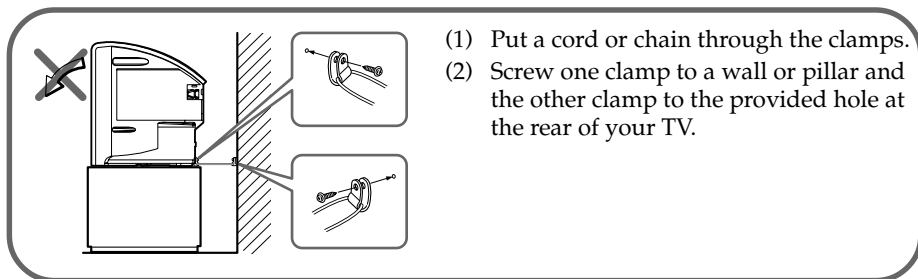

- (1) Put a cord or chain through the clamps.
- (2) Screw one clamp to a wall or pillar and the other clamp to the provided hole at the rear of your TV.

or

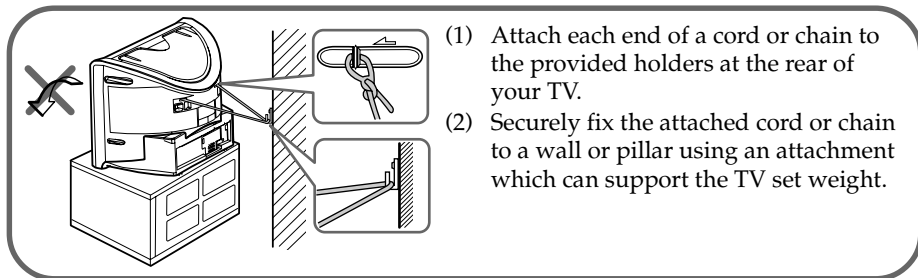

- (1) Attach each end of a cord or chain to the provided holders at the rear of your TV.
- (2) Securely fix the attached cord or chain to a wall or pillar using an attachment which can support the TV set weight.

Note

- Use only the supplied screws. Use of other screws may damage the TV.

■ Getting Started

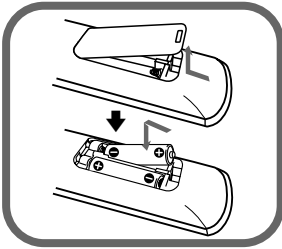

Step 1

Insert the batteries (supplied) into the remote.

Note

- Do not use old or different types of batteries together.

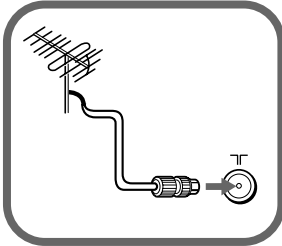

Step 2

Connect the antenna cable (not supplied) to  (antenna input) at the rear of the TV.

Tip

- You can also connect your TV to other optional components (see page 27).

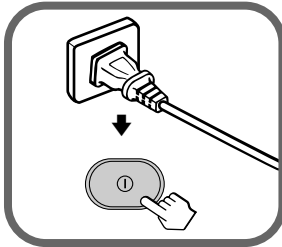

Step 3

Plug in the power cord, then press  on the TV to turn it on.

Note

- The  (standby) indicator flashes green for a few seconds when turning on the TV. This does not indicate a malfunction.



Step 4

Set up the TV by following the instructions of the “Initial Setup” menu (see page 6).

■ Setting up your TV (“Initial Setup”)

When you turn on your TV for the first time, the “Initial Setup” menu will appear. You may change the menu language, preset the TV channels automatically, sort or edit the channels and adjust the picture position using the buttons on the remote control or TV front panel.

- 1** Press **▲** or **▼** to select the desired menu language, then press **⊕**.

The selected menu language appears.

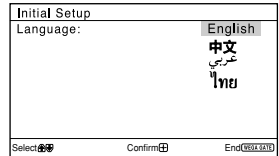

- 2** Press **▲** or **▼** to select “Yes”, then press **⊕** to preset the channels automatically.

The screen will indicate automatic presetting is in progress.

After all available channels have been tuned and stored, the “Program Sorting/Edit” menu appears automatically on the screen.

To skip automatic channel presetting, select “No”, then press **⊕**.

If the message “No channel found. Please connect cable/antenna” appears, check your TV connections, then press **⊕**.

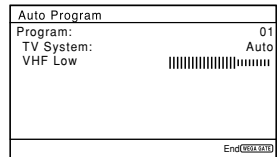
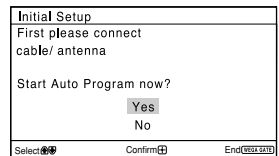

- 3** The “Program Sorting/Edit” menu enables you to sort and edit the channels.

- If you wish to keep the channels in the current condition, press WEGA GATE to exit.
- Press **▲** or **▼** to select the program number with the channel you wish to change. The selected channel will appear on the screen.
- If you wish to store the channels in a different order:
 - Press **➡** to enter sorting mode.
 - Press **▲** or **▼** to select the new program number position for your selected channel, then press **⬅**.

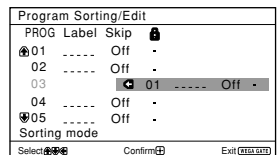
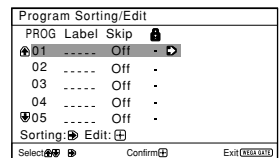

- d) If you wish to edit the channels, press \odot to change to edit mode.

Press \rightarrow until the mode that you wish to edit is highlighted: Label, Skip, \mathbb{A} (block symbol). Then press \odot .

- 1) To label, press \uparrow or \downarrow to select the alphanumeric characters for the label. Then press \odot .
- 2) To skip the program number, press \uparrow or \downarrow to select "On". Then press \odot .
You can skip this program number when using PROG +/-.
- 3) To block unwanted program number, press \uparrow or \downarrow to select \mathbb{A} . Then press \odot .

- e) Repeat step b) to d) if you wish to change other channels.

Press WEGA GATE to go to the next menu.

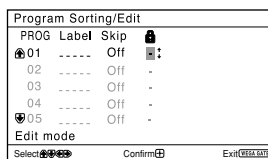
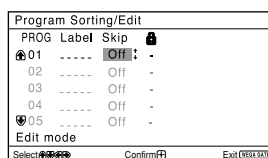
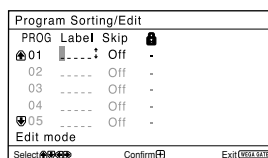

- 4** Press \leftarrow or \rightarrow to adjust the bars on the top and bottom of the menu if they are slanted, then press \odot .

"Picture V-Position" menu appears.

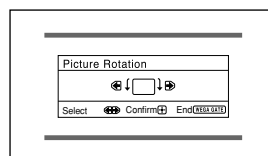

- 5** If the upper and lower bars are not equally positioned to the top and bottom of the screen, press \uparrow or \downarrow to adjust them, then press \odot .

If no adjustment is necessary, then press \odot .

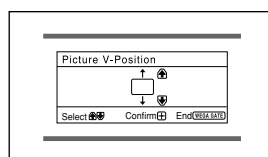

- 6** To prevent this "Initial Setup" menu from appearing again when you turn on the TV by pressing \odot , press \uparrow or \downarrow to select "No", then press \odot .

To allow this menu to appear again, select "Yes", then press \odot .

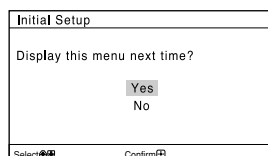

Tip

You can immediately go to the end of the "Initial Setup" menu by pressing WEGA GATE.

Note

- Before adjusting "Picture Rotation" and "Picture V-Position", keep external speakers or other electrical equipment away from the TV. The magnetic disturbance from these equipments or the direction of the earth's magnetic field may affect the TV.

TV front and rear panels

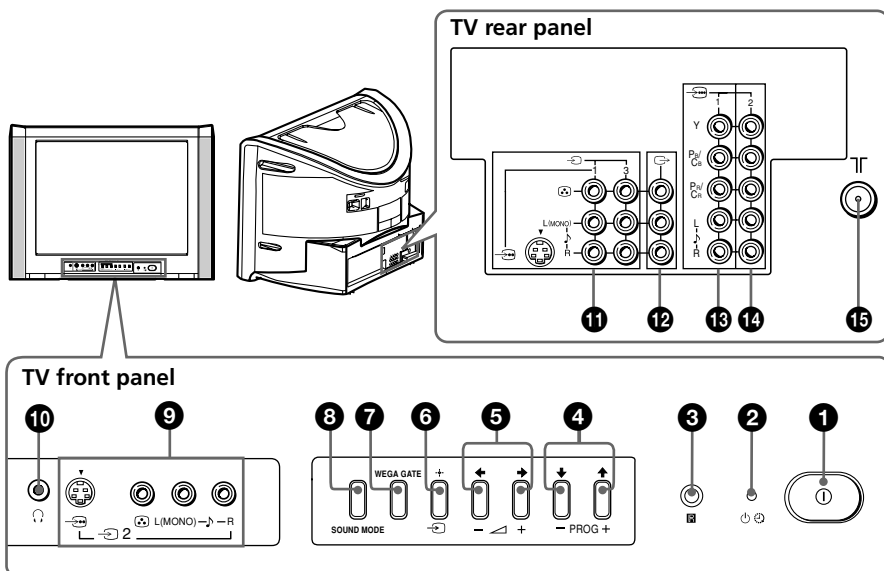

Button/Terminal	Function	Page
① ①	Turn off or turn on the TV.	5
② ①	Standby indicator.	5
③ ①	Wake Up indicator.	9
④ ①	Remote control sensor.	-
⑤ PROG +/-	Select program number.	-
⑥ +/-	Adjust volume.	-
⑦ ①	Select TV or video input.	27
WEGA GATE menu operations		
④, ⑤ ↑, ↓, ←, →	Select and adjust items.	15
⑥ ①	Confirm selected items.	15
⑦ WEGA GATE	Display or cancel WEGA GATE menu.	15
⑧ SOUND MODE	Select sound mode options with a 5-Band Graphic Equalizer display.	11
⑨ ①	Video input terminal 2.	27
⑩ ①	Headphone jack.	-
⑪ ①, ③	Video input terminal 1, 3.	27
⑫ ①	Monitor output terminal.	27
⑬ ①	Component video input terminal 1.	28
⑭ ②	Component video input terminal 2.	28
⑮ ①	Antenna input terminal.	27



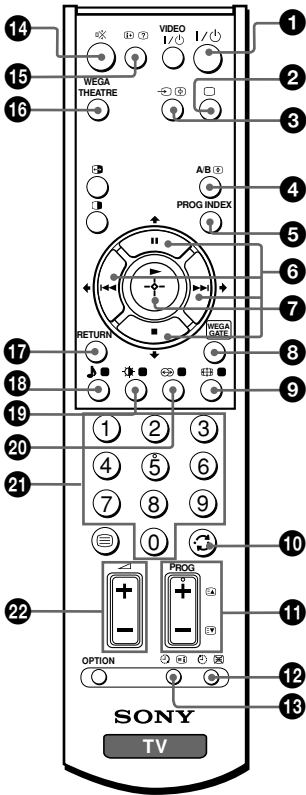





■ Using the remote control and basic functions

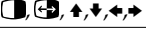
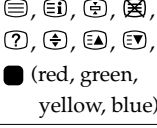

Button	Description	Page
1 I/Power	Turn off temporarily or turn on the TV.	-
2 TV/Video	Display the TV program.	-
3 Input/Source	Select TV or video input.	27
Stereo/bilingual operations		
4 A/B	Select stereo/bilingual mode.	13
5 PROG INDEX	Not function for your TV.	-
WEGA GATE menu operations		
6 ↑, ↓, ←, →	Select and adjust items.	15
7 +	Confirm selected items.	15
8 WEGA GATE	Display or cancel WEGA GATE menu.	15
17 RETURN	Return to the previous level.	15
9 Picture size	Change the picture size: "4:3", "16:9" (16:9 wide mode).	-
10 Last program	Jump to last program number that has been watched for at least five seconds.	-
11 PROG +/-	Select program number.	-
Timer operations		
12 Sleep Timer	Set TV to turn off automatically according to the desired period of time (max. of one hour and 30 min.).	-
13 Wake Up Timer	Set TV to turn on automatically according to the desired period of time (max. of 12 hours). The indicator on TV lights up amber once you set the wake up timer. If no buttons or controls are pressed for more than one hour after the TV is turned on using the wake up timer, the TV automatically goes into standby mode.	-
14 Mute	Mute the sound.	-
15 On-Screen Information	Display on-screen information.	-
16 WEGA THEATRE	Select WEGA Theatre Mode.	12

continue

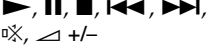
continued

Button	Description	Page
18 	Select sound mode options with a 5-Band Graphic Equalizer display.	11
19 	Select picture mode options.	11
20 	Select surround mode options.	20
21 0 – 9	Input numbers. For program numbers 10 and above, enter the second digit within two seconds.	–
22  +/-	Adjust volume.	–
TWIN picture operations 		
Teletext operations (green label)  ● (red, green, yellow, blue)	Not function for your TV.	–
Optional components operations VIDEO I/  , OPTION,  		
	For details, see “Operating optional components”.	14

Licensed by BBE Sound, Inc. under USP4638258, 4482866.
 “BBE” and BBE symbol are trademarks of BBE Sound, Inc.

■ Selecting the picture and sound modes

You can select picture and sound modes and adjust the setting to your preference in the “Custom” option.

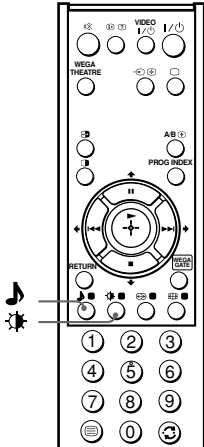



Selecting the picture mode

Press  to select the desired picture mode.

Select	To view
“Vivid”	contrast and sharp pictures.
“Standard”	normal pictures.
“Custom”	the last adjusted picture setting from the “Picture Adjustment” option in the menu (see page 19).

Selecting the sound mode

Press  (or SOUND MODE on the front panel) to select the desired sound mode. 5-Band Graphic Equalizer display will appear.

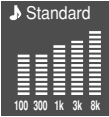
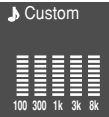
Select	To listen to
“Dynamic” 	dynamic and clear sound that emphasizes both the low and high tones.
“Standard” 	sound that emphasizes voice and high tones.
“Custom” 	the last adjusted sound setting from the “Sound Adjustment” option in the menu (see page 21).

■ Enjoying the WEGA Theatre Mode

The WEGA Theatre Mode enables you to enjoy the best picture, sound and surround effect of a cinema from a DVD source.

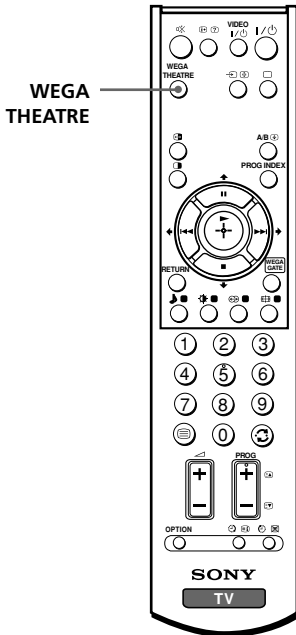

Setting up WEGA Theatre Mode

1. Place your TV and connected Sony equipment adjacent to each other so that you can control both the TV and the connected equipment by using the TV's remote control at the same time (see page 14).
2. Select the proper video input from "WEGA Theatre Setup" menu and turn on (main power) the connected equipment (see page 25).
3. See the table below. If the connected equipment is a Sony audio/video equipment, you can set up the remote to work with the connected equipment (see page 14).

To	Press
switch to WEGA Theatre Mode	WEGA THEATRE. Be sure to aim the remote control at the TV set and connected equipment for about one second after the button is pressed. The connected equipment turns on automatically from standby mode and will start playing (only for Sony audio/video equipment). The "Picture Mode" and "Sound Mode" will switch automatically to "Custom" and you can adjust the setting to your personal preference (see pages 19 and 21).

Notes

- The WEGA Theatre Mode is automatically cancelled when you change the input mode or turn the TV off and on again.
- Some Sony equipment might not respond properly when WEGA THEATRE button is pressed. In this case, use the equipment's own remote control.

Enjoying stereo or bilingual programs

You can enjoy stereo sound or bilingual programs of NICAM and A2 stereo systems by using the A/B button.

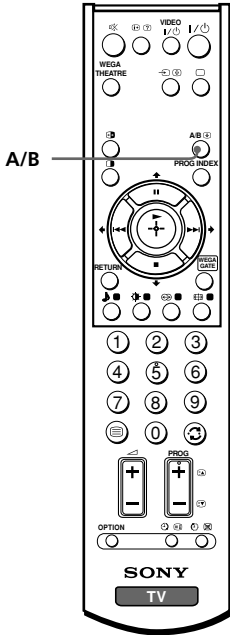

When receiving a NICAM program

Broadcasting	On-screen display (Selected sound)
NICAM stereo	NICAM (Stereo sound) → Mono (Regular sound)
NICAM bilingual	NICAM Main (Main sound) → NICAM Sub (Sub sound) → Mono (Regular sound)
NICAM monaural	NICAM Main (Main sound) → Mono (Regular sound)

When receiving an A2 program

Broadcasting	On-screen display (Selected sound)
A2 stereo	Stereo (Stereo sound) → Mono (Regular sound)
A2 bilingual	Main (Main sound) → Sub (Sub sound)

Note

- If the stereo sound is noisy when receiving a stereo program, select “Mono”. The sound becomes monaural but the noise is reduced.

■ Operating optional components

You can use the supplied remote to operate Sony audio/video equipment.

Setting up the remote to work with other connected equipment

While keeping VIDEO I/⏻ pressed, press the corresponding number button for the desired equipment (see the chart below).

For example, to operate a Sony 8 mm VCR:

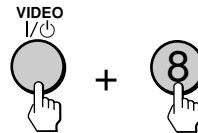

To control	Hold down VIDEO I/⏻ and press
Audio System 1, 1x, 2 or 3	0, 1, 2, or 3
DVD 1, 2 or 3	4, 5 or 6
VTR1 (Beta), VTR2 (8 mm) or VTR3 (VHS)	7, 8 or 9

Operating audio/video equipment

Press VIDEO I/⏻ or while keeping OPTION pressed, press ►, ■, ◀◀, ►►, ||, ⏏ or ◀ +/- (see the chart below).

To	Press
turn on/off	VIDEO I/⏻
play	► while keeping OPTION pressed.
stop	■ while keeping OPTION pressed.
fast forward/ step forward or rewind/ step backward	►► or ◀◀ while keeping OPTION pressed.
pause	while keeping OPTION pressed. Press again to resume normal playback.
mute the sound (Audio System 1, 1x, 2 or 3 only)	⏏ while keeping OPTION pressed.
adjust volume (Audio System 1, 1x, 2 or 3 only)	◀ +/- while keeping OPTION pressed.

Notes

- If the equipment does not have a certain function, the corresponding button on the remote will not operate.
- Some equipment might not respond properly to buttons on TV's remote. In this case, use the equipment's own remote control.

Introducing the WEGA GATE navigator

WEGA GATE is a gateway that allows you access to preset TV channels, connected external inputs and "Settings" menu.

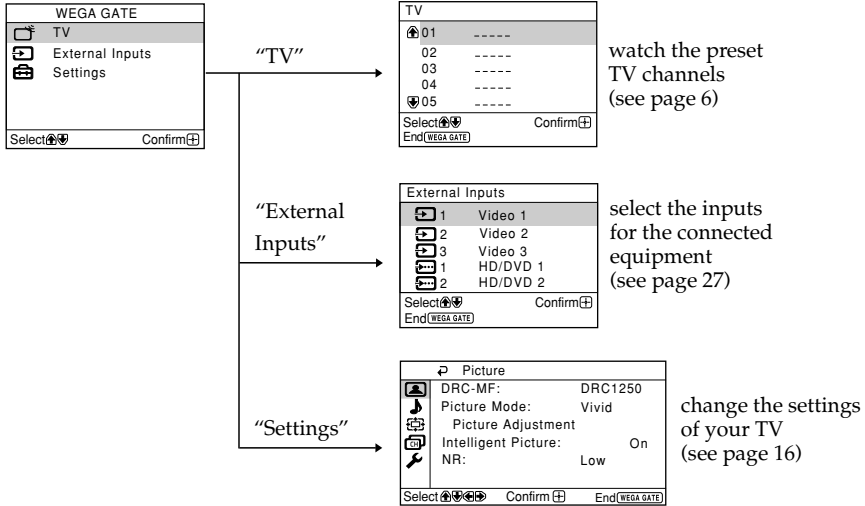

How to use WEGA GATE

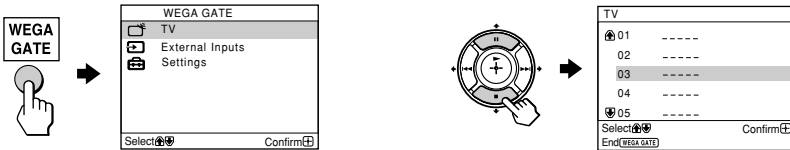

(1) Press WEGA GATE to display or cancel the WEGA GATE menu.

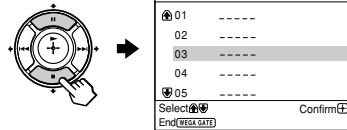

(3) Press \uparrow or \downarrow to select the desired item.

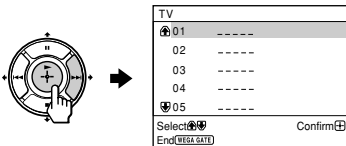

(2) Press \odot (or \rightarrow) to confirm your selection or go to the next level.

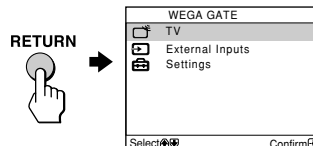

(4) Press RETURN to move to the previous level.

Tip

- The WEGA GATE, \odot , \uparrow , \downarrow , \leftarrow , \rightarrow buttons on the front panel can also be used for the operations above.

■ “Settings” Adjustment

You are able to change the settings of your TV from “Settings” in WEGA GATE menu.

Press WEGA GATE button to display WEGA GATE menu. Press \blacktriangle or \blacktriangledown to select “Settings” and press \oplus .

The following is an overview of the items that can be adjusted.

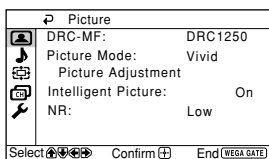

“Picture” (see page 18)

“DRC-MF”: “DRC1250” \rightarrow “DRC100” \rightarrow “Progressive”

“Picture Mode”: “Vivid” \rightarrow “Standard” \rightarrow “Custom”

“Picture Adjustment”: “Picture”, “Brightness”, “Color”, “Hue”, “Sharpness”, “Color Temperature”, “Reset”

“Intelligent Picture”: “On” \rightarrow “Off”

“NR”: “High” \rightarrow “Low” \rightarrow “Off”

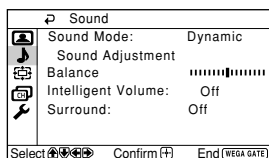

“Sound” (see page 20)

“Sound Mode”: “Dynamic” \rightarrow “Standard” \rightarrow “Custom”

“Sound Adjustment”: “Adjust”, “Reset”

“Balance”

“Intelligent Volume”: “On” \rightarrow “Off”

“Surround”: “On” \rightarrow “Simulated” \rightarrow “Off”

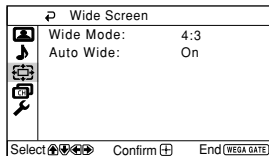

“Wide Screen” (see page 22)

“Wide Mode”: “16:9” \rightarrow “4:3”

“Auto Wide”: “On” \rightarrow “Off”

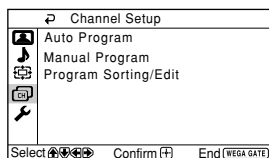

“Channel Setup” (see page 23)

“Auto Program”

“Manual Program”

“Program”: “00” - “99”

“TV System”: “B/G” \rightarrow “I” \rightarrow “D/K” \rightarrow “M”

“VHF Low” / “VHF High” / “UHF”

“Fine”: “Auto” \rightarrow “Manual”

“Signal Booster”: “Auto” \rightarrow “Off”

“Program Sorting/Edit”

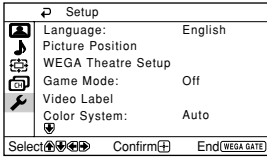

"Setup" (see page 25)

"Language": "English" → "中文" (Chinese) → "عربي" (Arabic) → "ไทย" (Thai)

"Picture Position": "Picture Rotation", "Picture V-Position"

"WEGA Theatre Setup": "Direct Input"

"Game Mode": "On" → "Off"

"Video Label"

"Color System": "Auto" → "PAL" → "SECAM" → "NTSC3.58" → "NTSC4.43"

"Eco Mode": "On" → "Off"

"Factory Settings": "Yes" → "No"

Note

- When a feature is dimmed in the menu, it is not selectable.

■ Changing the “Picture” setting

The “Picture” menu allows you to adjust the picture settings.

1 Press WEGA GATE and select “Settings”.

2 Make sure the “Picture” icon (👤) is selected, then press (⊕).

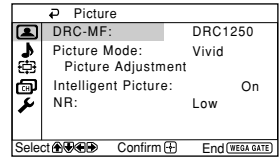

3 Press ↑ or ↓ to select the desired item (e.g., “DRC-MF”), then press (⊕).

Select	To
“DRC-MF”	choose either “DRC1250” (for high density pictures), “DRC100” (reduce flicker on the screen) or “Progressive” (reduce jitter of any small areas or scanning lines on the screen).
“Picture Mode”	choose either “Vivid”, “Standard” or “Custom”* (see page 11).
“Intelligent Picture”	optimize picture quality. Press ↑ or ↓ to select “On”, then press (⊕). To cancel, select “Off”, then press (⊕).
“NR” (Noise Reduction)	optimize overall picture sharpness to reduce noise. Choose either “High”, “Low” or “Off”.

* You can adjust the setting to your personal preference in the “Picture Adjustment” option only when the “Custom” mode is selected (see page 19).

Notes

- The DRC-MF mode is not selectable when “Game Mode” mode is turned “On”. The mode is not available for HD (high-definition) and progressive input signals.
- “NR” is not selectable when receiving signals through the (S) (S video input) or (C) (component video input) terminals.

The DRC-MF logo () and “DRC-MF” are trademarks of Sony Corporation.

Adjusting the “Picture Adjustment” items under “Custom” mode

- 1** Press **▲** or **▼** to select either “Picture” (contrast), “Brightness”, “Color”, “Hue” (color tones), “Sharpness” or “Color Temperature” (choose either “Cool”, “Neutral” or “Warm”), then press **⊕**.

Selecting “Reset” will set your TV to the factory settings.

- 2** Press **▲**, **▼**, **←** or **→** to adjust the setting of your selected item, then press **⊕**.
-

- 3** Repeat the above steps to adjust other items.

The adjusted settings will be received when you select “Custom”.

Notes

- “Hue” can be adjusted for the NTSC color system only.
- Reducing “Sharpness” can also reduce picture noise.

■ Changing the “Sound” setting

The “Sound” menu allows you to adjust the sound settings.

1 Press WEGA GATE and select “Settings”.

2 Press ↑ or ↓ to select the “Sound” icon (🔊), then press ⏺.

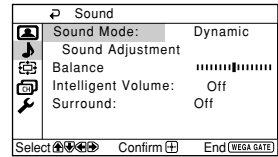

3 Press ↑ or ↓ to select the desired item (e.g., “Sound Mode”), then press ⏺.

Select	To
“Sound Mode”	choose either “Dynamic”, “Standard” or “Custom”* (see page 11).
“Balance”	Press ↓ or ← to emphasize the left speaker. Press ↑ or → to emphasize the right speaker.
“Intelligent Volume”	adjust the volume of all program numbers and video inputs automatically. Press ↑ or ↓ to select “On”, then press ⏺. To cancel, select “Off”, then press ⏺.
“Surround”	choose either “On” (surround), “Simulated” (stereo-like monaural sound) or “Off”.

* You can adjust the setting to your personal preference in the “Sound Adjustment” option only when the “Custom” mode is selected (see page 21).





Adjusting the “Sound Adjustment” items under “Custom” mode

The 5-Band Graphic Equalizer feature allows you to adjust sound frequency settings of “Custom” mode in the menu.

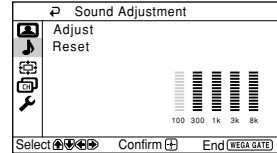
- 1 Make sure that “Adjust” is selected, then press .

Selecting “Reset” will set your TV to the factory settings.



- 2 Press  or  to select the desired sound frequency, then press  or  to adjust the setting and press .

The adjusted settings will be received when you select “Custom”.

Notes

- Adjusting higher frequency will affect higher pitched sound and adjusting lower frequency will affect lower pitched sound.
- You may display the settings directly by using the SOUND MODE button on the TV front panel (see page 8) or  button on the remote control (see page 10).

■ Changing the “Wide Screen” setting

The “Wide Screen” menu allows you to view the picture with optimal effect when receiving wide-mode (16:9) picture signal.

1 Press WEGA GATE and select “Settings”.

2 Press ↑ or ↓ to select the “Wide Screen” icon (), then press (+).

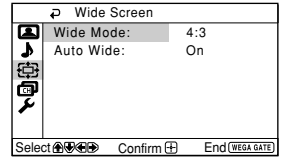

3 Press ↑ or ↓ to select the desired item (e.g., “Wide Mode”), then press (+).

Select	To
“Wide Mode”	change the size of the picture when receiving wide-mode (16:9) picture signal. Choose “16:9”. To restore the normal picture size, select “4:3”, then press (+).
“Auto Wide”	display the picture in optimum wide screen automatically when you choose “On”. To cancel, select “Off”, then press (+).

Tip

- You can also change to wide-mode picture size by pressing the  button on the remote control (see page 9).

Notes

- “Wide Mode” is not selectable for high-definition (1080i, 720p) input signals. For HD (1080i, 720p) input signals, your TV will always display wide mode picture.
- “Auto Wide” is only available when receiving 576i, 480p and 480i input signals.

■ Changing the “Channel Setup” setting

The “Channel Setup” menu allows you to preset channels automatically, manually preset channels and sort or edit the channels.

1 Press WEGA GATE and select “Settings”.

2 Press \uparrow or \downarrow to select the “Channel Setup” icon (📺), then press \oplus .

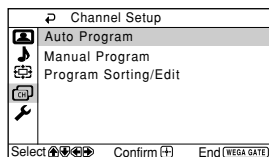

3 Press \uparrow or \downarrow to select the desired item (e.g., “Auto Program”), then press \oplus .

Select	To
“Auto Program”	preset channels automatically.
“Manual Program”	manually preset desired channels and channels that cannot be preset automatically (see Presetting channels manually in page 24).
“Program Sorting/Edit”	change the order in which the channels appear on the screen, label the program number, skip the program number and block unwanted programs. (see step 3 of the section “Initial Setup” in page 6).

Notes

- If you preset a blocked program number, that program number will be unblocked automatically.
- If you sort a blocked program, that program will remain blocked.

continue

continued

Presetting channels manually

1 After selecting “Manual Program”, select the program number to which you want to preset a channel.

- (1) Make sure “Program” is selected, then press \oplus .
- (2) Press \uparrow or \downarrow until the program number you want to preset appears on the menu, then press \oplus .

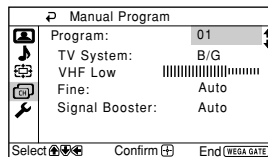

2 Select the desired channel.

- (1) Make sure either “VHF Low”, “VHF High” or “UHF” is selected, then press \oplus .
- (2) Press \uparrow or \downarrow until the desired channel’s broadcast appears on the TV screen, then press \oplus .

3 If the sound of the desired channel is abnormal, select the appropriate TV system.

- (1) Press \uparrow or \downarrow to select “TV System”, then press \oplus .
- (2) Press \uparrow or \downarrow until the sound becomes normal, then press \oplus .

4 If you are not satisfied with the picture and sound quality, you may be able to improve them by using the “Fine” tuning feature.

- (1) Press \uparrow or \downarrow to select “Fine”, then press \oplus .
- (2) Press \uparrow or \downarrow to select “Manual”, then press \oplus .
- (3) Press \uparrow , \downarrow , \leftarrow or \rightarrow until the picture and sound quality are optimal, then press \oplus .
The + or – icon on the menu flashes while tuning.

5 If the TV signal is too strong (picture distorted; picture with lines; signal interference) or weak (snowy picture), you may be able to improve the picture quality by setting the “Signal Booster” feature.

- (1) Press \uparrow or \downarrow to select “Signal Booster”, then press \oplus .
- (2) Press \uparrow or \downarrow to select “Off” (for picture distorted; picture with lines; signal interference) or “Auto” (for snowy picture), then press \oplus .

■ Changing the “Setup” setting

The “Setup” menu allows you to change the menu language, adjust the picture position, setup WEGA Theatre Mode, adjust suitable picture setting for video games, label the connected equipment, select the color system, reduce your TV power consumption and reset your TV to factory settings.

1 Press WEGA GATE and select “Settings”.

2 Press \uparrow or \downarrow to select the “Setup” icon (🔧), then press \oplus .

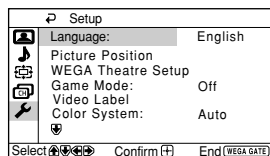

3 Press \uparrow or \downarrow to select the desired item (e.g., “Language”), then press \oplus .

Select	To
“Language”	change the menu language. Press \uparrow or \downarrow to select either “English”, “中文” (Chinese), “عربي” (Arabic) or “ไทย” (Thai), then press \oplus .
“Picture Position”	adjust the picture position when it is not aligned with the TV screen. Press \uparrow or \downarrow to select “Picture Rotation” or “Picture V-Position”, then press \oplus . Press \uparrow , \downarrow , \leftarrow or \rightarrow to adjust the picture position, then press \oplus .
“WEGA Theatre Setup”	setup WEGA Theatre Mode for best picture, sound and surround effect enjoyment of a cinema (see page 12). Make sure “Direct Input” is selected, then press \oplus . Press \uparrow or \downarrow to select either “Video 1”, “Video 2”, “Video 3”, “HD/DVD 1” or “HD/DVD 2” for the connected equipment that you want to view with WEGA Theatre, then press \oplus .
“Game Mode”	adjust the picture setting that is suitable to view video games. Press \uparrow or \downarrow to select “On”, then press \oplus . To cancel, select “Off”, then press \oplus .

continue

continued

Select	To
"Video Label"	label the connected equipment. (1) Press ▲ or ▼ to select the input you want to label, then press ⊕ . (2) Press ▲ or ▼ to select the label options: "Video 1"/"Video 2"/"Video 3"/ "HD/DVD 1"/"HD/DVD 2", "VCR", "SAT", "Game" or "Edit"*, then press ⊕ . * You may edit the video label to your favorite name. Press ▲ or ▼ to select alphanumeric characters for the label, then press ⊕ .
"Color System"	select the color system. Press ▲ or ▼ to select either "Auto", "PAL", "SECAM", "NTSC3.58" or "NTSC4.43", then press ⊕ . Normally, set this to "Auto".
"Eco Mode"	reduce power consumption of your TV to save energy. Press ▲ or ▼ to select "On", then press ⊕ . When you press ⏻ or turn on the TV, Eco Mode (ECO) symbol will appear on the screen for a while. To cancel, select "Off", then press ⊕ .
"Factory Settings"	reset your TV to factory settings. Press ⊕ and press ▲ or ▼ to select "Yes", then press ⊕ . To cancel, select "No", then press ⊕ .

Notes

- You cannot adjust "Picture Rotation" and "Picture V-Position" when high-definition (1080i, 720p) signals are input.
- "Game Mode" is available only when receiving signals through the **↔** (video input), **↔** (S video input) or **↔** (component video input) terminals.
- When HD (high-definition) or progressive signals are input, "Game Mode" does not function.

■ Connecting optional components

Connecting to the video input terminal (→)

TV front panel

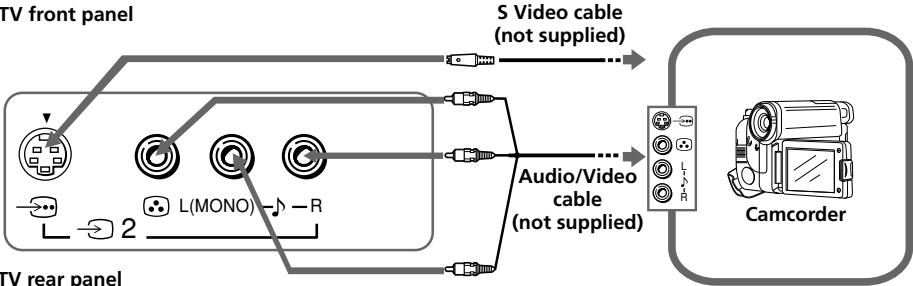

TV rear panel

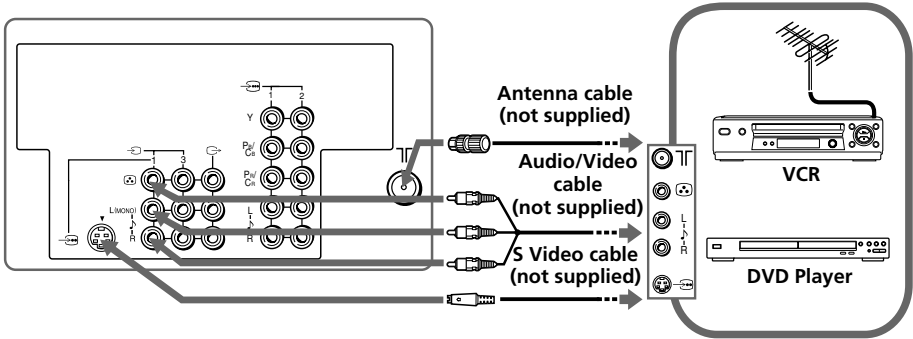

Notes

- If you connect a VCR to 1 (antenna input), preset the signal output from the VCR to the program number 0 on the TV (see page 24).
- When both 1 (S video) and 2 (video) for 1 or 2 are connected at the same time, 1 (S video) is automatically selected. To view 2 (video), disconnect the S video cable.

Connecting to the monitor output terminal (⇨)

TV rear panel

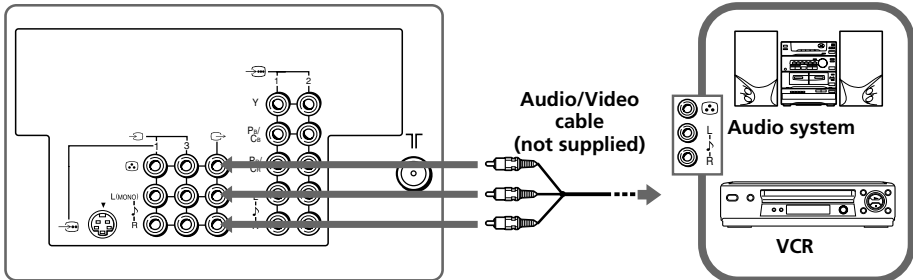

continue

continued

Connecting to the component video input terminal ()

TV rear panel

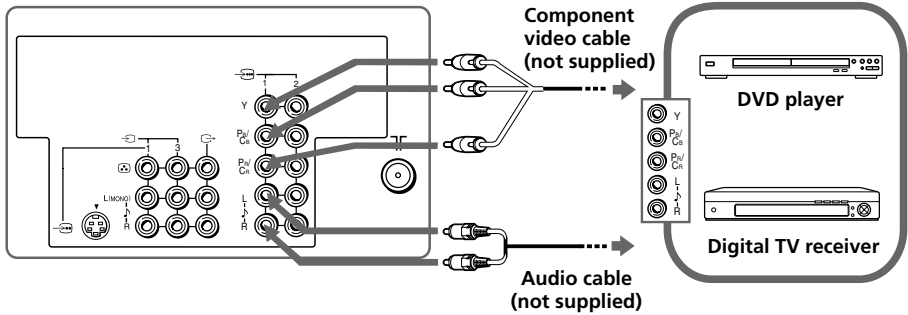

Notes

- The component video terminals on your DVD player are sometimes labeled Y/C_B/C_R, Y/P_B/P_R, Y/C_b/C_r or Y/B-Y/R-Y.
- If you select “HD/DVD 1” or “HD/DVD 2” on your TV screen, the signal from the  (monitor output) terminals will not be output properly. This does not indicate a malfunction.

Tip

- The TV accepts the following signal formats:

Total scanning line	Effective scanning line	fV (Hz)
1125i	1080i	50/60
750p	720p	50/60
625p	576p	50
625i	576i	50
525p	480p	60
525i	480i	60

Troubleshooting

If you find any problem while viewing your TV, you can either use the “Factory Settings” function or check the Troubleshooting guide below. If the problem persists, contact your Sony dealer.

“Factory Settings” function

Press the WEGA GATE button. Choose “Settings” and go to “Setup” (🔧) menu. From “Setup” menu, select “Factory Settings”. Then select “Yes” and press (⊕). Your TV will go blank for a few seconds, then the “Initial Setup” menu will appear. Your TV will be set to factory settings, but certain problems may be solved.



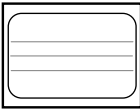

Symptom	Solutions
Snowy picture, noisy sound	<ul style="list-style-type: none"> • Check the antenna cable and connection on the TV, VCR and at the wall (see page 27). • Check the antenna setup. Contact a Sony dealer for advice. • Display the “Channel Setup” menu and select “Manual Program” to preset the channel again (see page 24). • Display the “Channel Setup” menu and set the “Signal Booster” to “Auto” from “Manual Program” (see page 24). • Try using an external booster.
Distorted picture, noisy sound	<ul style="list-style-type: none"> • Turn off or disconnect the external booster if it is in use. • Display the “Channel Setup” menu and set the “Signal Booster” to “Off” from “Manual Program”(see page 24).
Good picture, noisy sound	<ul style="list-style-type: none"> • Display the “Channel Setup” menu and select the appropriate “TV System” from “Manual Program” (see page 24).
No picture, no sound	<ul style="list-style-type: none"> • Check the power cord, antenna and VCR connections (see page 27). • Press I/⏻ (power) to turn on the TV (see page 9). • Press Ⓛ (main power) on the TV to turn off the TV for about five seconds, then turn it on again (see page 8).
Good picture, no sound	<ul style="list-style-type: none"> • Press 🔊 + to increase the volume level (see page 10). • Press 🔇 to cancel the muting (see page 9).
Dotted lines or stripes	<ul style="list-style-type: none"> • Do not use a hair dryer or other equipment near the TV. • Check the antenna setup. Contact a Sony dealer for advice.
Double images or “ghosts”	<ul style="list-style-type: none"> • Use the fine tuning (“Fine”) function (see page 24). • Check the antenna setup. Contact a Sony dealer for advice. • Turn off or disconnect the external booster if it is in use.
No color	<ul style="list-style-type: none"> • Display the “Picture” menu and select “Custom” from “Picture Mode”, then adjust the “Color” level from “Picture Adjustment” (see page 19). • Display the “Setup” menu and check the “Color System” setting (usually set this to “Auto”) (see page 26). • Check the antenna setup. Contact a Sony dealer for advice.
Picture slant	<ul style="list-style-type: none"> • Keep external speakers or other electrical equipment away from the TV. • Display the “Picture Position” under “Setup” menu, then adjust “Picture Rotation” and “Picture V-Position” so that the picture is aligned to the TV screen (see page 25).

continue

continued

Symptom	Solutions
Abnormal color patches	<ul style="list-style-type: none"> • Keep external speakers or other equipment away from the TV. Do not move the TV while the TV is turned on. Press Ⓚ (main power) on the TV to turn off the TV for about 15 minutes, then turn it on again to demagnetize the TV.
TV cannot receive stereo broadcast sound or Stereo broadcast sound switches on and off or is distorted.	<ul style="list-style-type: none"> • Check the antenna cable and connection on the TV, VCR and at the wall (see page 27). • Check the antenna setup. Contact a Sony dealer for advice.
The Ⓚ (standby) indicator on your TV flashes red several times after every three seconds.	<ul style="list-style-type: none"> • Count the number of times the Ⓚ (standby) indicator flashes. Press Ⓚ (main power) to turn off your TV. Contact your nearest Sony service center.
The TV screen sometimes goes blank for slightly longer than usual during channel change.	<ul style="list-style-type: none"> • The “Signal Booster” is functioning to detect a weak signal. This does not indicate a malfunction.
Cannot play shooting games.	<ul style="list-style-type: none"> • Some shooting games which involve pointing a light beam at the TV screen with an electronic gun or rifle cannot be used with your TV. For details, see the instruction manual supplied with the video game software.
TV cabinet creaks.	<ul style="list-style-type: none"> • Changes in room temperature sometimes make the TV cabinet expand or contract, causing a noise. This does not indicate a malfunction.
A small “boom” sound is heard when the TV is turned on.	<ul style="list-style-type: none"> • The TV’s demagnetizing function is working. This does not indicate a malfunction.
Thin lines appear on the TV Screen. 	<ul style="list-style-type: none"> • The visible lines that sometimes appear on your TV screen are shadows from the damper wires used to stabilize the aperture grille of the Trinitron picture tube. This does not indicate a malfunction.

Specifications

	KV-DB29M30	Note
Power requirements	220-240 V AC, 50/60 Hz	
Power consumption (W)	Indicated on the rear of the TV	
Television system	B/G, I, D/K, M	
Color system	PAL, PAL 60, SECAM, NTSC3.58, NTSC4.43	
Stereo/Bilingual system	NICAM Stereo/Bilingual B/G, I; A2 Stereo/Bilingual B/G	
Channel coverage		
B/G	VHF : E2 to E12 /UHF : E21 to E69 / CATV : S01 to S03, S1 to S41	
I	UHF : B21 to B68 /CATV : S01 to S03, S1 to S41	
D/K	VHF : C1 to C12, R1 to R12 / UHF : C13 to C57, R21 to R60 / CATV : S01 to S03, S1 to S41, Z1 to Z39	
M	VHF : A2 to A13 /UHF : A14 to A79/ CATV : A-8 to A-2, A to W+4, W+6 to W+84	
⏏ (Antenna)	75-ohm external terminal	
Audio output (Speaker)	10 W + 10 W	
Number of terminal		
 (Video)	Input: 3 Output: 1 Phono jacks; 1 Vp-p, 75 ohms	
 (Audio)	Input: 5 Output: 1 Phono jacks; 500 mVrms	
 (S Video)	Input: 2 Y: 1 Vp-p, 75 ohms, unbalanced, sync negative C: 0.286 Vp-p, 75 ohms	
 (Component Video)	Input: 2 Phono jacks; Y: 1 Vp-p, 75 ohms, sync negative P _B /C _B : 0.7 Vp-p, 75 ohms P _R /C _R : 0.7 Vp-p, 75 ohms	
 (Headphone)	Output: 1 Stereo minijack	
Picture tube	29 in.	
Tube size (cm)	72	Measured diagonally
Screen size (cm)	68	Measured diagonally
Dimensions (w/h/d,mm)	765 × 584 × 544	
Mass (kg)	49	

Design and specifications are subject to change without notice.