

# *Projection TV*

---

## Operating Instructions \_\_\_\_\_

**GB**

- Before operating the unit, please read this manual thoroughly and retain it for future reference.

# WEGA

*KP-FR43*

*KP-FR53*

M94  
M90

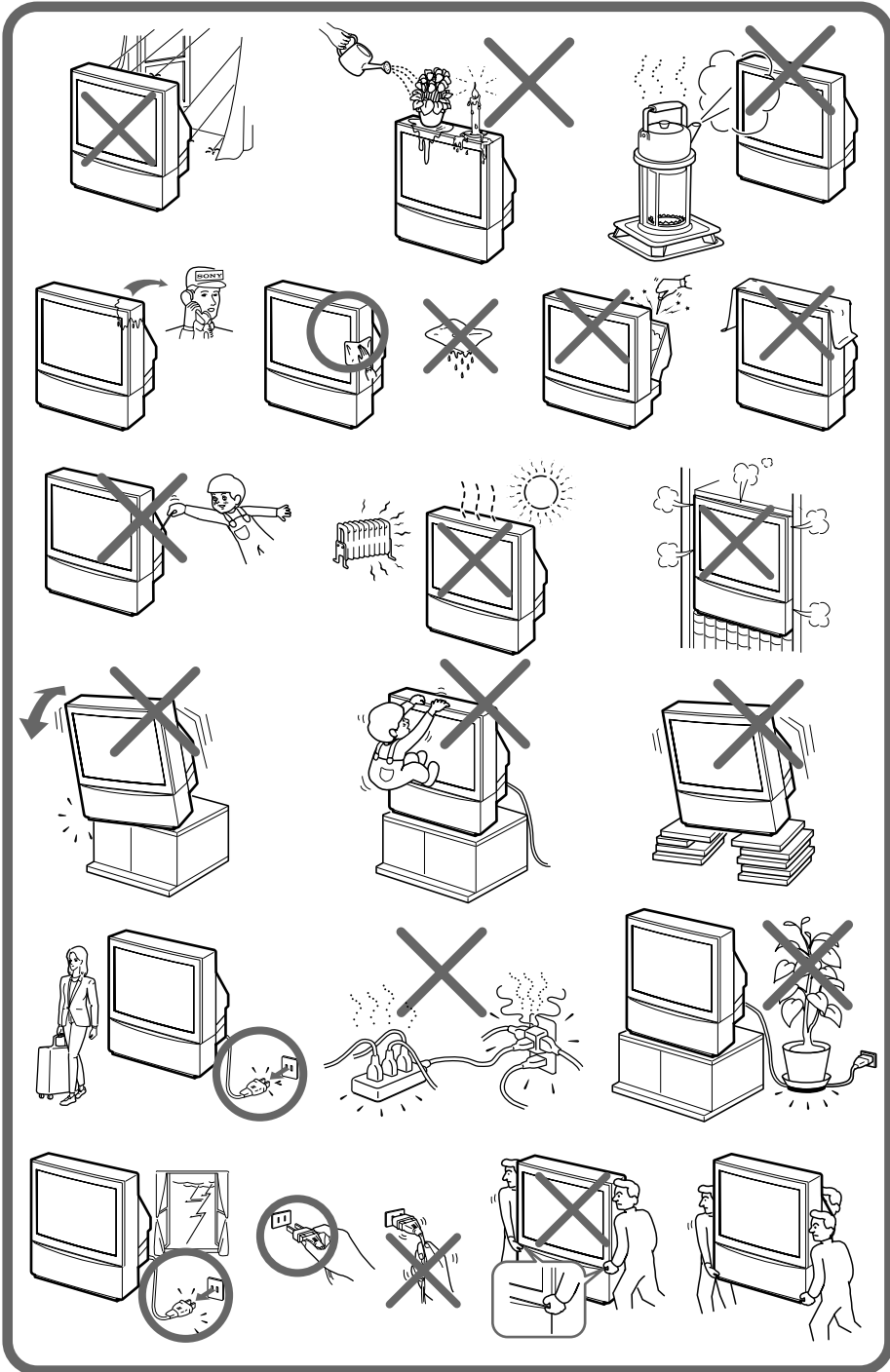

# WARNING

To prevent fire or shock hazard, do not expose the projection TV to rain or moisture. Dangerously high voltages are present inside the projection TV. Do not open the cabinet. Refer servicing to qualified personnel only.

## For general safety:

- Do not expose the projection TV to rain or moisture.
- Do not open the rear cover.

## For safe installation:

- Do not block the ventilation openings.
- Do not install the projection TV in hot, humid or excessively dusty places.
- Do not install the projection TV where it may be exposed to mechanical vibrations.
- Avoid operating the projection TV at temperatures below 5°C (41°F).
- If the projection TV is transported directly from a cold to a warm location, or if the room temperature has changed suddenly, the picture may be blurred or show poor color. This is because moisture has condensed on the mirror or lenses inside. If this happens, let the moisture evaporate before using the projection TV.
- To obtain the best picture, do not expose the screen to direct illumination or direct sunlight. It is recommended to use spot lighting directed down from the ceiling or to cover the windows that face the screen with opaque drapery. It is desirable to install the projection TV in a room where the floor and walls are not of reflecting material. If necessary, cover them with dark carpeting or wall paper.
- Do not install the appliance in a confined space, such as a bookcase or built-in cabinet.

## For safe operations:

- Do not operate the projection TV on anything but 110-240 V AC, 50/60 Hz.
- Do not operate the projection TV if any liquid or solid object falls in it—have it checked immediately.
- Do not keep the projection TV plugged in if you are not going to use it for several days. Even if your projection TV is turned off, it is still connected to the AC power source (mains) as long as the power cord is plugged in.
- Do not pull the power cord to disconnect the projection TV. Pull it out by the plug.
- Do not plug in too many appliances to the same power socket. Do not damage the power cord.
- Do not place any objects on the projection TV. The apparatus shall not be exposed to dripping or splashing and that no objects filled with liquids, such as vases, shall be placed on the apparatus.
- Install the projection TV on a stable projection TV stand and floor which can support the projection TV set weight. Ensure that the projection TV stand surface is flat and its area is larger than the bottom area of the projection TV.
- Do not carry the projection TV holding the screen edges.

## Caution

- When using TV games, computers, and similar products with your projection TV, keep the brightness and contrast functions at low settings. If a fixed (non-moving) pattern is left on the screen for long periods of time at a high brightness or contrast setting, the image can be permanently imprinted onto the screen. These types of imprints are not covered by your warranty.

## Cleaning the Screen

- To clean the screen with a cloth, please use a cleaning cloth lightly moistened with water. Do not use any type of abrasive pad, alkaline cleaner, scouring powder or solvent, such as alcohol or benzene. As a safety precaution, unplug the projection TV before cleaning it.
- Do not rub, touch, or tap the surface of the screen with sharp or abrasive items, like a ball point pen or a screw driver. Otherwise, this type of contact may result in a scratched screen.

## ■ Install the projection TV

For the best picture quality, install the projection TV within the areas below.

### Optimum viewing area (Horizontal)

KP-FR43

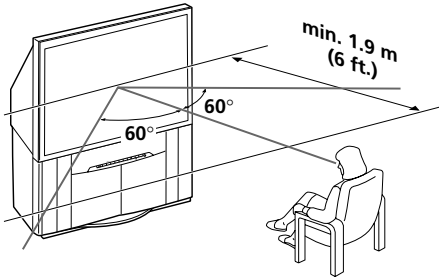

KP-FR53

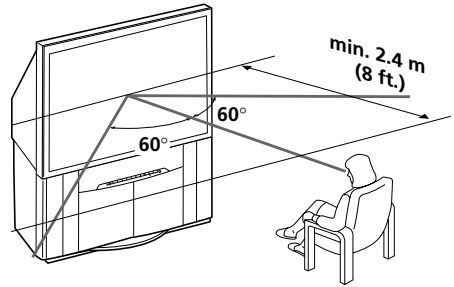

### Optimum viewing area (Vertical)

KP-FR43

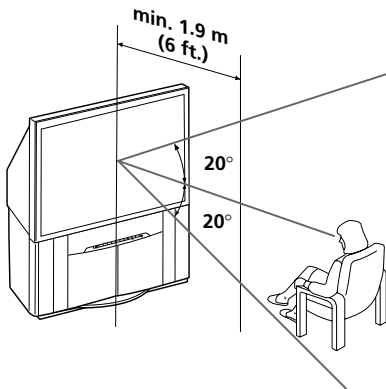

KP-FR53

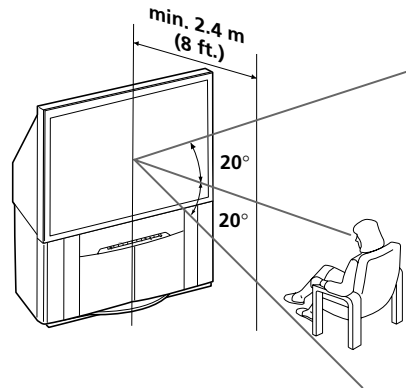

---

# Table of Contents

---

## Using Your New Projection TV

---

### Installation

Getting Started .....	6
Setting up your projection TV ("Initial Setup") .....	7

---

### Overview of Controls

Projection TV front, inside the drop- down and rear panels .....	9
Using the remote control and basic functions .....	10

---

### Advanced Operations

Selecting the picture and sound modes .....	12
Enjoying the WEGA Theatre Mode with center speaker .....	13
Viewing two programs at the same time (KP-FR53M94 only) .....	14
Displaying multiple programs (KP-FR53M94 only) .....	15
Enjoying stereo or bilingual programs .....	16
Operating optional components .....	17

## Menu Adjustment

Introducing the WEGA GATE navigator .....	18
"Settings" Adjustment .....	19
Changing the "Picture" setting .....	21
Changing the "Sound" setting .....	22
Changing the "Wide Screen" setting .....	23
Changing the "Multi Picture" setting (KP-FR53M94 only) .....	24
Changing the "Channel Setup" setting .....	25
Changing the "Setup" setting .....	27

---

## Additional Information

Connecting optional components ...	29
Troubleshooting .....	32
Specifications .....	Back cover

**GB**

## ■ Getting Started

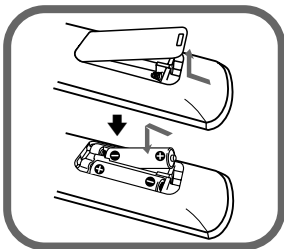

### Step 1

Insert the batteries (supplied) into the remote.

#### Note

- Do not use old or different types of batteries together.

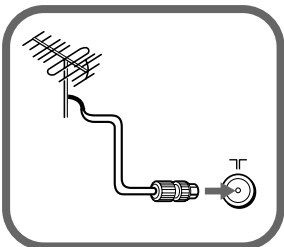

### Step 2

Connect the antenna cable (not supplied) to  $\nabla$  (antenna input) at the rear of the projection TV.

#### Tip

- You can also connect your projection TV to other optional components (see page 29).

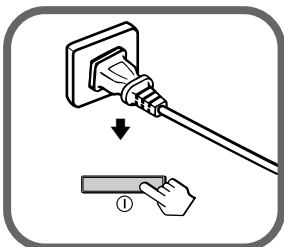

### Step 3

Plug in the power cord, then press  $\text{⏻}$  on the projection TV to turn it on.

#### Note

- The  $\text{⏻}$  (standby) indicator flashes green for a few seconds when turning on the projection TV. This does not indicate a malfunction.



### Step 4

Set up the projection TV by following the instructions of the "Initial Setup" menu (see page 7).

# ■ Setting up your projection TV (“Initial Setup”)

When you turn on your projection TV for the first time, the “Initial Setup” menu will appear. You may change the menu language, preset the TV channels automatically, sort or edit the channels and adjust the convergence using the buttons on the remote control or projection TV front panel.

- 1** Press **▲** or **▼** to select the desired menu language, then press **⊕**.

The selected menu language appears.

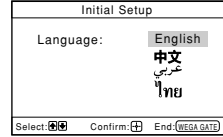

- 2** Press **▲** or **▼** to select “Yes”, then press **⊕** to preset the channels automatically.

The screen will indicate automatic presetting is in progress.

After all available channels have been tuned and stored, the “Program Sorting/Edit” menu appears automatically on the screen.

To skip automatic channel presetting, select “No”, then press **⊕**.

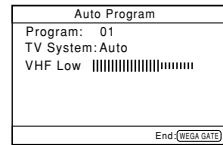
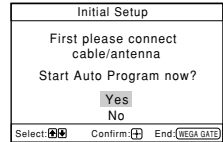

If the message “No channel found. Please connect cable/antenna” appears, check your projection TV connections, then press **⊕**.

- 3** The “Program Sorting/Edit” menu enables you to sort and edit the channels.

- If you wish to keep the channels in the current condition, press WEGA GATE to exit.
- Press **▲** or **▼** to select the program number with the channel you wish to change. The selected channel will appear on the screen.
  - If you wish to store the channels in a different order:
    - Press **➡** to enter sorting mode.
    - Press **▲** or **▼** to select the new program number position for your selected channel, then press **◀**.

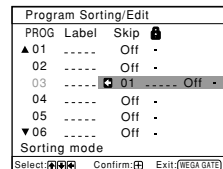
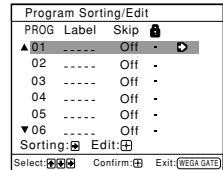

continue

## continued

- d) If you wish to edit the channels, press  $\oplus$  to change to edit mode. Press  $\rightarrow$  until the mode that you wish to edit is highlighted: Label, Skip,  $\mathbb{L}$  (block symbol). Then press  $\oplus$ .

1) To label, press  $\uparrow$  or  $\downarrow$  to select the alphanumeric characters for the label. Then press  $\oplus$ .

2) To skip the program number, press  $\uparrow$  or  $\downarrow$  to select "On". Then press  $\oplus$ .

You can skip this program number when using PROG +/-.

3) To block unwanted program number, press  $\uparrow$  or  $\downarrow$  to select  $\mathbb{L}$ . Then press  $\oplus$ .

- e) Repeat step b) to d) if you wish to change other channels.

Press WEGA GATE to go to the next menu.

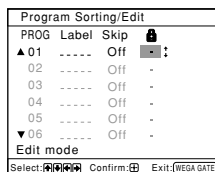
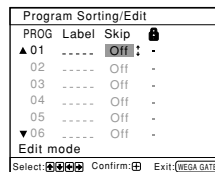
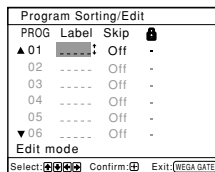

- 4** Make sure that "Yes" is selected, then press  $\oplus$  to start digital quick focus.

The convergence adjustment screen appears, and the convergence is automatically adjusted.

After the adjustment, the last "Initial Setup" menu appears automatically on the screen.

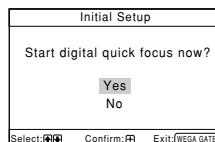

- 5** To prevent this "Initial Setup" menu from appearing again when you turn on the projection TV by pressing  $\text{O}$ , press  $\uparrow$  or  $\downarrow$  to select "No", then press  $\oplus$ .

To allow this menu to appear again, select "Yes", then press  $\oplus$ .

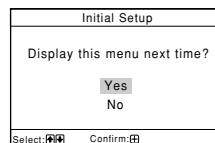

### Tip

- You can immediately go to the end of the "Initial Setup" menu by pressing WEGA GATE.

### Notes

- Convergence can also be adjusted manually using the menu (see page 27).
- You can also perform the Digital Quick Focus feature using  $\mathbb{L}$  on the front panel.
- Sound will be muted while the Digital Quick Focus feature is running.



## Projection TV front, inside the drop-down and rear panels

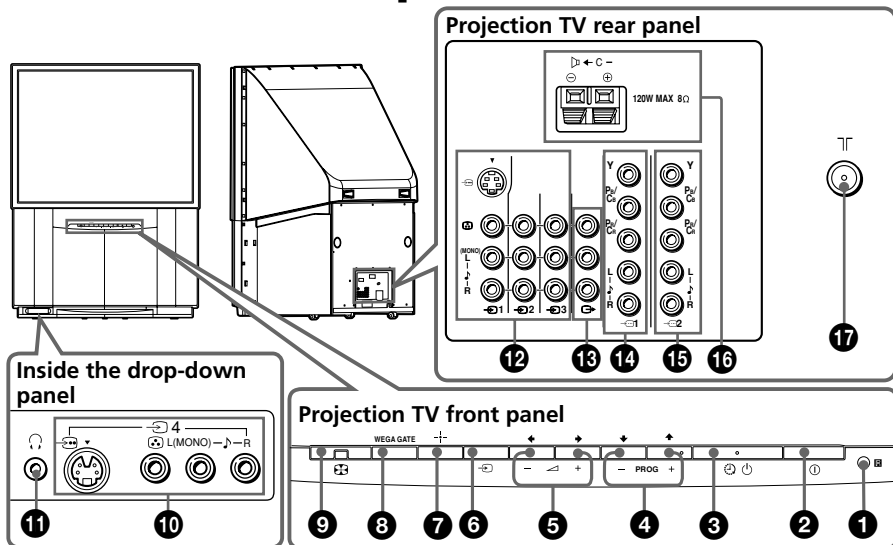

Button/Terminal	Function	Page
1	Remote control sensor.	-
2	Turn off or turn on the projection TV.	6
3	Standby indicator.	6
3	Wake Up indicator.	10
4 PROG +/-	Select program number.	-
5	Adjust volume.	-
6	Select TV or video input.	29
<b>WEGA GATE menu operations</b>		
4, 5	Select and adjust items.	18
7	Confirm selected items.	18
8 WEGA GATE	Display or cancel WEGA GATE menu.	18
9	Adjust convergence automatically.	27
10	Video input terminal 4.	29
11	Headphone jack.	-
12	Video input terminal 1, 2, 3.	29
13	Monitor output terminal.	29
14	Component video input terminal 1.	30
15	Component video input terminal 2.	30
16	Center speaker input terminal.	31
17	Antenna input terminal.	29

# Using the remote control and basic functions

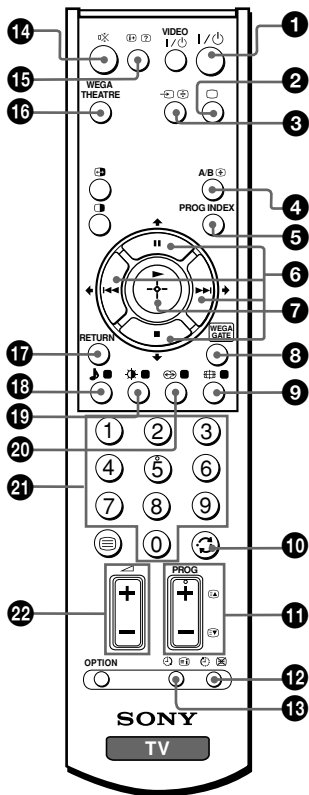

Button	Description	Page
1 I/⏻	Turn off temporarily or turn on the projection TV.	–
2 □	Display the TV program.	–
3 ↺	Select TV or video input.	29
<b>Stereo/bilingual operations</b>		
4 A/B	Select stereo/bilingual mode.	16
5 PROG INDEX (KP-FR53M94 only)	Display all preset TV programs.	15
<b>WEGA GATE menu operations</b>		
6 ↑, ↓, ←, →	Select and adjust items.	18
7 +	Confirm selected items.	18
8 WEGA GATE	Display or cancel the WEGA GATE.	18
17 RETURN	Return to the previous level.	18
9 4:3, 16:9	Change the picture size: "4:3", "16:9"(16:9 wide-mode).	–
10 ↺	Jump to last program number that has been watched for at least five seconds.	–
11 PROG +/-	Select program number.	–
<b>Timer operations</b>		
12 ⌚ (Sleep Timer)	Set projection TV to turn off automatically according to the desired period of time (max. of one hour and 30 min.).	–
13 ⌚ (Wake Up Timer)	Set projection TV to turn on automatically according to the desired period of time (max. of 12 hours). The ⌚ indicator on projection TV lights up amber once you set the wake up timer. If no buttons or controls are pressed for more than two hour after the projection TV is turned on using the wake up timer, the projection TV automatically goes into standby mode.	–
14 🔇	Mute the sound.	–
15 i+	Display on-screen information.	–
16 WEGA THEATRE	Select WEGA Theatre Mode.	13

Button	Description	Page
18	Select sound mode options.	12
19	Select picture mode options.	12
20	Select surround mode options.	22
21 0 – 9	Input numbers. For program numbers 10 and above, enter the second digit within two seconds.	–
22	Adjust volume.	–
<b>TWIN picture operations (KP-FR53M94 only)</b>		
	All buttons are used for Twin picture operations.	14
<b>Teletext operations (green label)</b>		
	Not function for your TV.	–
<b>Optional components operations</b>		
VIDEO , OPTION, 	For details, see “Operating optional components”.	17

TruSurround, SRS and ® symbol are trademarks of SRS Labs, Inc.  
TruSurround technology is incorporated under license from SRS Labs, Inc.

## ■ Selecting the picture and sound modes

You can select picture and sound modes and adjust the setting to your preference in the “Custom” option.

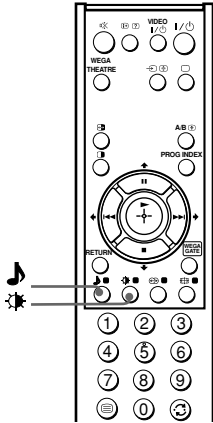

### Selecting the picture mode

Press to select the desired picture mode.

Select	To view
“Vivid”	contrast and sharp pictures.
“Standard”	normal pictures.
“Custom”	the last adjusted picture setting from the “Picture Adjustment” option in the menu (see page 21).

### Selecting the sound mode

Press to select the desired sound mode.

Select	To listen to
“Dynamic” <b>Dynamic</b>	dynamic and clear sound that emphasizes both the low and high tones.
“Standard” <b>Standard</b>	sound that emphasizes voice and high tones.
“Custom” <b>Custom</b>	the last adjusted sound setting from the “Sound Adjustment” option in the menu (see page 22).

# Enjoying the WEGA Theatre Mode with center speaker

The WEGA Theatre Mode enables you to enjoy the best picture, sound and surround effect of a cinema from a DVD source. You can use your projection TV speaker as the center speaker of your audio system for optimum vocal enhancement and control its sound volume from the remote of the projection TV.

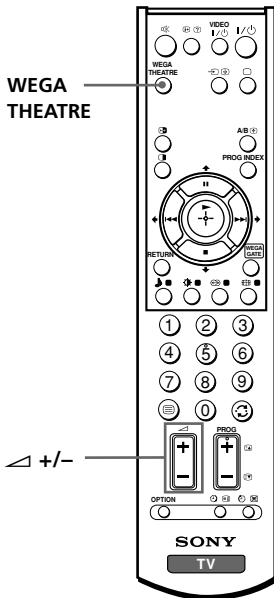

## Setting up WEGA Theatre Mode

1. Connect the center speaker terminals of the amplifier to the center speaker input terminal on the projection TV (see page 31).
2. Select the proper video input and center speaker mode from “WEGA Theatre Setup” menu and turn on (main power) the connected equipment (see page 27).
3. See the table below. If the connected equipment is a Sony audio/video equipment, you can set up the remote to work with the connected equipment (see page 17).

To	Press
switch to WEGA Theatre Mode	WEGA THEATRE. Be sure to aim the remote control at the projection TV set and connected equipment for about one second after the button is pressed. The connected equipment turns on automatically from standby mode and will start playing (only for Sony audio/video equipment). The “Picture Mode” and “Sound Mode” will switch automatically to “Custom” and you can adjust the setting to your personal preference (see pages 22 and 23).
adjust center speaker volume	△ +/-.

## Notes

- Be sure to place your projection TV and connected Sony equipment adjacent to each other so that you can control both the projection TV and the connected equipment by using the projection TV’s remote control at the same time (see page 17).
- The WEGA Theatre and center speaker modes are automatically cancelled when you change the program number, video input or turn the projection TV off and on again.
- When the projection TV is in the center speaker mode, you cannot use the Twin pictures feature, change the surround sound and the “Intelligent Volume” mode.
- Some Sony equipment might not respond properly when WEGA THEATRE button is pressed. In this case, use the equipment’s own remote control.
- To use the projection TV’s speakers as the center speaker, you can also display “Center Speaker” from “Sound” menu and select “On” (see page 22).

# ■ Viewing two programs at the same time

## ▶ KP-FR53M94 only

With the Twin pictures feature, you can display two different TV program or video input at the same time.

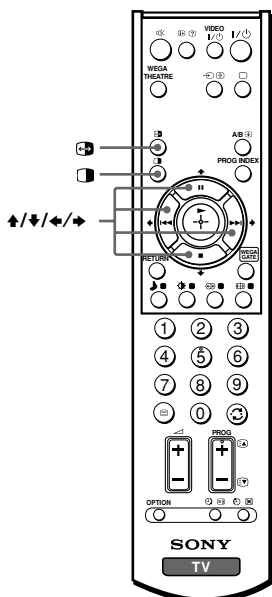

To	Press
display Twin pictures	. To cancel, press the button again.
select a program number in the right picture	▲ or ▼.
swap the left and right pictures	.
swap sound between the left and right pictures	◀ or ▶ once. A "♪" symbol will appear to indicate which screen you are hearing.
change the screen size of the Twin pictures	Hold ◀ to increase the left screen size. Hold ▶ to increase the right screen size.  Sound will swap automatically to the screen which is increasing in size.

## Selecting TV program from "TV" in WEGA GATE menu (see page 18) using PAP (Picture And Picture)

You can select your desired TV program directly from the right picture by using ▲ or ▼ buttons.

1. Press ▲ or ▼ until the desired program appears on the right picture.
2. Press (or ▶) to display the right picture in full screen.

### Notes

- You cannot change the picture size or swap the two pictures in the PAP mode.
- Swapping the pictures is not available for HD (high-definition) and DVD input signals in Twin mode.
- HD and DVD input signals are not available in the right picture.
- The Twin pictures feature is not available when the projection TV is in the center speaker mode (see page 13) and you cannot set the projection TV to the center speaker mode while viewing the Twin pictures.
- You can only enjoy stereo sound from the left picture.
- You cannot change the picture to a video input in the right picture. You can only display a video input, except for HD and DVD input signals, in the right picture by swapping the pictures when a video input is displayed in the left picture.
- The picture and sound from the (monitor output) terminals will always be from the left picture, even when you select the sound from the right picture by swapping the sound.
- Due to different video processors used, it is normal that the picture quality of the right picture might be slightly different from the left picture.

# ■ Displaying multiple programs

## ► KP-FR53M94 only

The Program Index feature displays all tuned TV programs scrolling on the screen for direct selection.

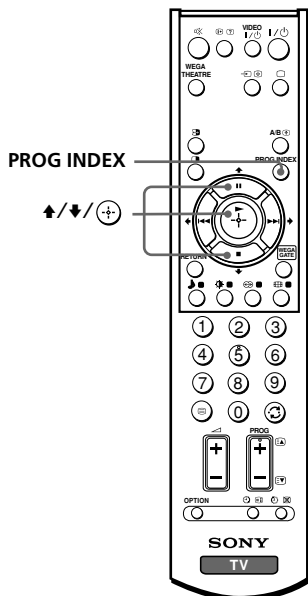

### 1 Press PROG INDEX.

The current program is displayed on the left. The first tuned program is displayed on the bottom right of the screen, then frozen.

It scrolls up and the next program appears on the bottom-right until all tuned programs appear one by one.

### 2 Press ▲ or ▼ until the program you want to view is displayed in the frame, then press (+).

To return to scrolling, press ▲ or ▼ again.

### 3 Press (+) again to enlarge the selected program into the left frame.

### 4 Press PROG INDEX.

The selected program is displayed in full screen.

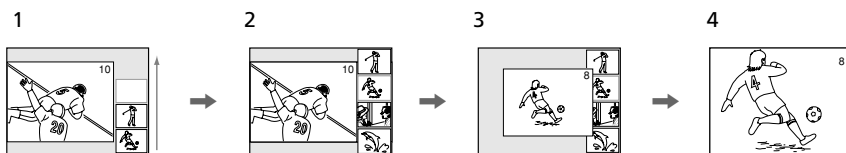

#### Note

- When displaying multiple programs, only the sound of the left picture is heard.

# ■ Enjoying stereo or bilingual programs

You can enjoy stereo sound or bilingual programs of NICAM and A2 stereo systems by using the A/B button.

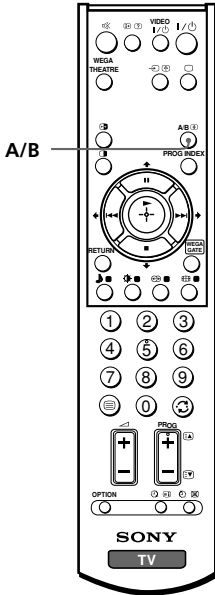

## When receiving a NICAM program

Broadcasting	On-screen display (Selected sound)
NICAM stereo	NICAM (Stereo sound) → Mono (Regular sound)
NICAM bilingual	NICAM Main (Main sound) → NICAM Sub (Sub sound) → Mono (Regular sound)
NICAM monaural	NICAM Main (Main sound) → Mono (Regular sound)

## When receiving an A2 program

Broadcasting	On-screen display (Selected sound)
A2 stereo	Stereo (Stereo sound) → Mono (Regular sound)
A2 bilingual	Main (Main sound) → Sub (Sub sound)

### Note

- If the stereo sound is noisy when receiving a stereo program, select “Mono”. The sound becomes monaural but the noise is reduced.



# ■ Operating optional components

You can use the supplied remote to operate Sony audio/video equipment.

## Setting up the remote to work with other connected equipment

While keeping VIDEO I/⏻ pressed, press the corresponding number button for the desired equipment (see the chart below).

For example, to operate a Sony 8 mm VCR:

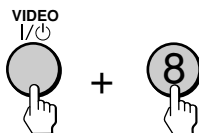

To control	Hold down VIDEO I/⏻ and press
Audio System 1, 1x, 2 or 3	0, 1, 2 or 3
DVD 1, 2 or 3	4, 5 or 6
VTR1 (Beta), VTR2 (8 mm) or VTR3 (VHS)	7, 8 or 9

## Operating audio/video equipment

Press VIDEO I/⏻ or while keeping OPTION pressed, press ►, ■, ◀◀, ▶▶, ||, ⏏ or ◀ +/- (see the chart below).

To	Press
turn on/off	VIDEO I/⏻
play	► while keeping OPTION pressed.
stop	■ while keeping OPTION pressed.
fast forward/ step forward or rewind/ step backward	▶▶ or ◀◀ while keeping OPTION pressed.
pause	while keeping OPTION pressed. Press again to resume normal playback.
mute the sound (Audio System 1, 1x, 2 or 3 only)	⏏ while keeping OPTION pressed.
adjust volume (Audio System 1, 1x, 2 or 3 only)	◀ +/- while keeping OPTION pressed.

### Notes

- If the equipment does not have a certain function, the corresponding button on the remote will not operate.
- Some equipment might not respond properly to buttons on projection TV's remote. In this case, use the equipment's own remote control.

## Introducing the WEGA GATE navigator

WEGA GATE is a gateway that allows you access to preset TV channels, connected external inputs and “Settings” menu.

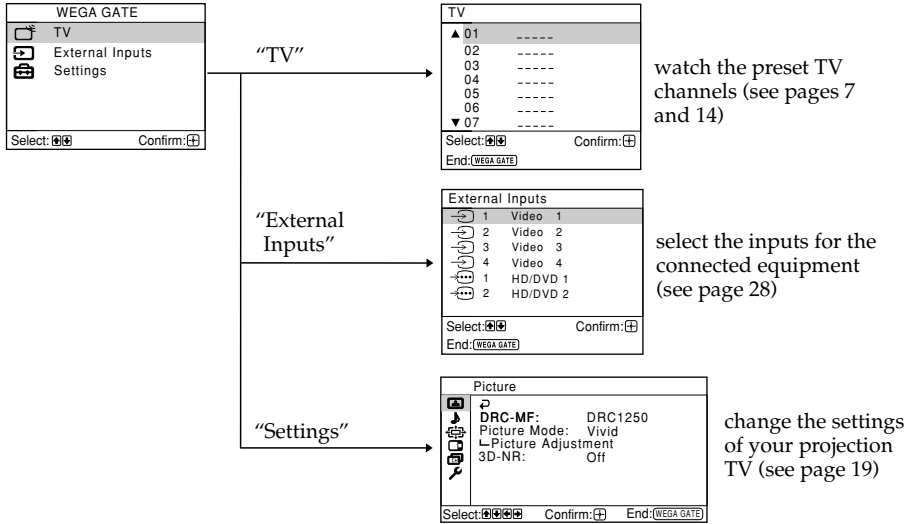

### How to use WEGA GATE



- (1) Press WEGA GATE to display or cancel the WEGA GATE menu.

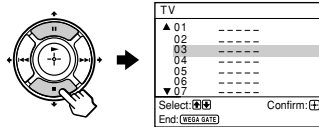

- (3) Press  $\uparrow$  or  $\downarrow$  to select the desired item.

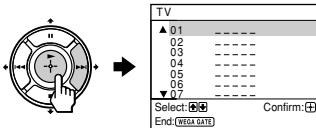

- (2) Press  $\oplus$  (or  $\rightarrow$ ) to confirm your selection or go to the next level.

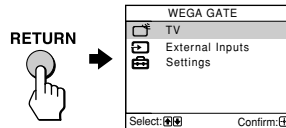

- (4) Press RETURN to move to the previous level.

#### Tip

- The WEGA GATE,  $\oplus$ , and  $\uparrow, \downarrow, \leftarrow, \rightarrow$  buttons on the front panel can also be used for the operations above.

# ■ “Settings” Adjustment

You are able to change the settings of your projection TV from “Settings” in WEGA GATE menu.

Press WEGA GATE button to display WEGA GATE menu. Press  $\uparrow$  or  $\downarrow$  to select “Settings” and press  $\oplus$ .

The following is an overview of the items that can be adjusted.

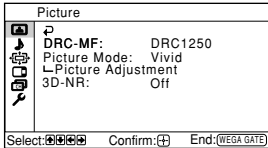

## “Picture” (see page 21)

“DRC-MF”: “DRC1250” → “DRC100” → “Progressive”

“Picture Mode”: “Vivid” → “Standard” → “Custom”

“Picture Adjustment”: “Picture”, “Brightness”, “Color”, “Hue”, “Sharpness”, “Color Temperature”, “Reset”

“3D-NR”: “On” → “Off”

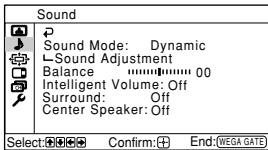

## “Sound” (see page 22)

“Sound Mode”: “Dynamic” → “Standard” → “Custom”

“Sound Adjustment”: “Treble”, “Bass”, “BBE”\*, “Reset” “Balance”

“Intelligent Volume”: “On” → “Off”

“Surround”: “TruSurround” → “Simulated” → “Off”

“Center Speaker”: “On” → “Off”

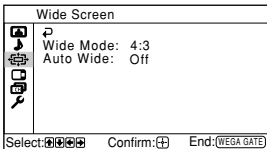

## “Wide Screen” (see page 23)

“Wide Mode”: “16:9” → “4:3”

“Auto Wide”: “On” → “Off”

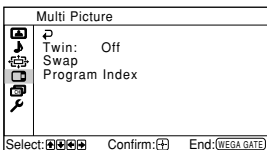

## “Multi Picture” (KP-FR53M94 only) (see page 24)

“Twin”: “On” → “Off”

“Swap”

“Program Index”

continue

**continued**

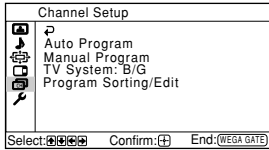

### **"Channel Setup"** (see page 25)

"Auto Program"

"Manual Program"

"Program": "00" - "99"

"TV System": "B/G" → "I" → "D/K" → "M"

"VHF Low" / "VHF High" / "UHF"

"Fine": "Auto" → "Manual"

"Signal Booster": "Auto" → "Off"

"Sensitivity": "High" → "Low"

"TV System": "B/G" → "I" → "D/K" → "M"

"Program Sorting/Edit"

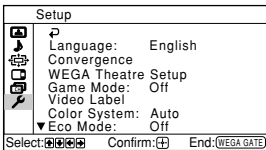

### **"Setup"** (see page 27)

"Language": "English" → "中文" (Chinese) → "عربي" (Arabic)  
→ "ไทย" (Thai)

"Convergence": "Digital Quick Focus", "Manual Adjust"

"WEGA Theatre Setup": "Direct Input", "Speaker"

"Game Mode": "On" → "Off"

"Video Label": "Video Input", "Label"

"Color System": "Auto" → "PAL" → "SECAM" →  
"NTSC3.58" → "NTSC4.43"

"Eco Mode": "On" → "Off"

"S input": "Auto" → "Off"

"Factory Settings": "Yes" → "No"

#### **Note**

- When a feature is dimmed in the menu, it is not selectable.

\* Licensed by BBE Sound, Inc. under USP4638258, 4482866.

"BBE" and BBE symbol are trademarks of BBE Sound, Inc.

# ■ Changing the “Picture” setting

The “Picture” menu allows you to adjust the picture settings.

**1** Press WEGA GATE and select “Settings”.

**2** Make sure the “Picture” icon (🖼️) is selected, then press (+).

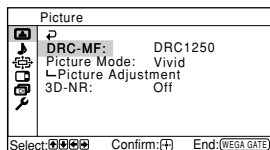

**3** Press ↑ or ↓ to select the desired item (e.g., “DRC-MF”), then press (+).

Select	To
“DRC-MF”	choose either “DRC1250” (for high density pictures), “DRC100” (reduce flicker on the screen) or “Progressive” (reduce jitter of any small areas or scanning lines on the screen).
“Picture Mode”	choose either “Vivid”, “Standard” or “Custom”* (see page 12).
“3D-NR”	improve the picture quality of TV or video if a signal received is weak. Press ↑ or ↓ to select “On”, then press (+). To cancel, select “Off”, then press (+).

\* You can adjust the setting to your personal preference in the “Picture Adjustment” option only when the “Custom” mode is selected.

## Adjusting the “Picture Adjustment” items under “Custom” mode

**1** Press ↑ or ↓ to select either “Picture” (contrast), “Brightness”, “Color”, “Hue” (color tones), “Sharpness” or “Color Temperature” (choose either “Cool”, “Neutral” or “Warm”), then press (+).

Selecting “Reset” will set your projection TV to the factory settings.

**2** Press ↑, ↓, ← or → to adjust the setting of your selected item, then press (+).

**3** Repeat the above steps to adjust other items.

The adjusted settings will be received when you select “Custom”.

### Notes



- The DRC-MF mode is not selectable when using the Program Index feature or when the “Game Mode” or “Twin” mode is turned “On”. The mode is not available for HD (high-definition) and progressive input signals.
- “Hue” can be adjusted for the NTSC color system only.
- Reducing “Sharpness” can also reduce picture noise.

The DRC-MF logo (  ) and “DRC-MF” are trademarks of Sony Corporation.

# ■ Changing the “Sound” setting



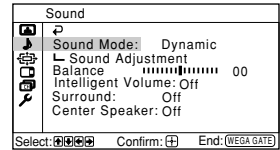

The “Sound” menu allows you to adjust the sound settings.

**1** Press WEGA GATE and select “Settings”.

**2** Press ↑ or ↓ to select the “Sound” icon (  ), then press .



**3** Press ↑ or ↓ to select the desired item (e.g., “Sound Mode”), then press .

Select	To
“Sound Mode”	choose either “Dynamic”, “Standard” or “Custom”* (see page 12).
“Balance”	Press ↓ or ← to emphasize the left speaker. Press ↑ or → to emphasize the right speaker.
“Intelligent Volume”	adjust the volume of all program numbers and video inputs automatically. Press ↑ or ↓ to select “On”, then press  .To cancel, select “Off”, then press  .
“Surround”	choose either “TruSurround” (surround sound that spreads out to the rear of a room), “Simulated” (stereo-like monaural sound) or “Off”.
“Center Speaker”	use your projection TV speaker to optimise vocal enhancement. Press ↑ or ↓ to select “On”, then press  .To cancel, select “Off”, then press  .

\* You can adjust the setting to your personal preference in the “Sound Adjustment” option only when the “Custom” mode is selected.

## Adjusting the “Sound Adjustment” item under “Custom” mode

**1** Press ↑ or ↓ to select either “Treble”, “Bass” or “BBE” (choose either “High”, “Low” or “Off”), then press .

Selecting “Reset” will set your projection TV to the factory settings.

**2** Press ↑, ↓, ← or → to adjust the setting of your selected item, then press .

**3** Repeat the above steps to adjust other items.

The adjusted settings will be received when you select “Custom”.

# ■ Changing the “Wide Screen” setting

The “Wide Screen” menu allows you to view the picture with optimal effect when receiving wide-mode (16:9) picture signal.

**1** Press WEGA GATE and select “Settings”.

**2** Press  $\uparrow$  or  $\downarrow$  to select the “Wide Screen” icon (⏏), then press  $\oplus$ .

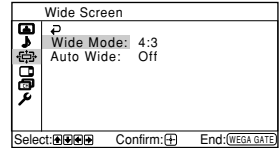

**3** Press  $\uparrow$  or  $\downarrow$  to select the desired item (e.g., “Wide Mode”), then press  $\oplus$ .

Select	To
“Wide Mode”	change the size of the picture when receiving wide-mode (16:9) picture signal. Choose “16:9”. To restore the normal picture size, select “4:3”, then press $\oplus$ .
“Auto Wide”	display the picture in optimum wide screen automatically when you choose “On”. To cancel, select “Off”, then press $\oplus$ .

## Tip

- You can also change to wide-mode picture size by pressing the  $\oplus$  button on the remote control (see page 10).

## Notes

- “Wide Mode” is not selectable for HD (1080i, 720p) input signals or in the right screen when viewing twin pictures. For HD (1080i, 720p) input signals, your projection TV will always display wide mode picture.
- “Auto Wide” is only available when receiving 576i, 480p and 480i input signals.

# ■ Changing the “Multi Picture” setting

## ▶ KP-FR53M94 only

The “Multi Picture” menu allows you to view two pictures on the screen at the same time, swap the picture of twin screen and display Program Index.

**1** Press WEGA GATE and select “Settings”.

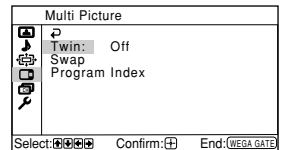

**2** Press  $\uparrow$  or  $\downarrow$  to select the “Multi Picture” icon (  ), then press  $\oplus$ .



**3** Press  $\uparrow$  or  $\downarrow$  to select the desired item (e.g., “Twin”), then press  $\oplus$ .

Select	To
“Twin”	display a different TV program beside the main picture. Press $\uparrow$ or $\downarrow$ to select “On”, then press $\oplus$ . To cancel, select “Off”, then press $\oplus$ .
“Swap”	swap the left and right pictures of the twin screen.
“Program Index”	view multiple programs on the sub-screens. To cancel, select “Program Index”, then press $\oplus$ .

### Tip

- You can also display or cancel the settings directly by pressing the ,  or PROG INDEX buttons on the remote control (see pages 14 and 15).



# ■ Changing the “Channel Setup” setting

The “Channel Setup” menu allows you to preset channels automatically, manually preset channels, select the TV system and sort or edit the channels.

**1** Press WEGA GATE and select “Settings”.

**2** Press  $\uparrow$  or  $\downarrow$  to select the “Channel Setup” icon (📺), then press  $\oplus$ .

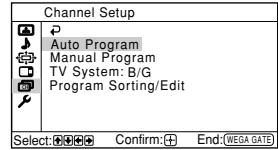

**3** Press  $\uparrow$  or  $\downarrow$  to select the desired item (e.g., “Auto Program”), then press  $\oplus$ .

Select	To
“Auto Program”	preset channels automatically.
“Manual Program”	manually preset desired channels and channels that cannot be preset automatically (see <b>Presetting channels manually</b> in page 26).
“TV System”	select the TV system. Press $\uparrow$ or $\downarrow$ to select either “B/G”, “I”, “D/K” or “M”, then press $\oplus$ .
“Program Sorting/Edit”	change the order in which the channels appear on the screen, label the program number, skip the program number and block unwanted programs. (see step 3 of the section “Initial Setup” in page 7).

## Notes

- If you preset a blocked program number, that program number will be unblocked automatically.
- If you sort a blocked program, that program will remain blocked.

**continue**

**continued**

## Presetting channels manually

**1** After selecting “Manual Program”, select the program number to which you want to preset a channel.

- (1) Make sure “Program” is selected, then press (+).
- (2) Press ▲ or ▼ until the program number you want to preset appears on the menu, then press (+).

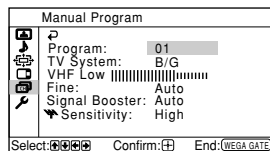

**2** Select the desired channel.

- (1) Make sure either “VHF Low”, “VHF High” or “UHF” is selected, then press (+).
- (2) Press ▲ or ▼ until the desired channel’s broadcast appears on the projection TV screen, then press (+).

**3** If the sound of the desired channel is abnormal, select the appropriate TV system.

- (1) Press ▲ or ▼ to select “TV System”, then press (+).
- (2) Press ▲ or ▼ until the sound becomes normal, then press (+).

**4** If you are not satisfied with the picture and sound quality, you may be able to improve them by using the “Fine” tuning feature.

- (1) Press ▲ or ▼ to select “Fine”, then press (+).
- (2) Press ▲ or ▼ to select “Manual”, then press (+).
- (3) Press ▲, ▼, ◀ or ▶ until the picture and sound quality are optimal, then press (+).

The + or – icon on the menu flashes while tuning.

**5** If the TV signal is too weak (snowy picture), you may be able to improve the picture quality by setting the “Signal Booster” feature.

- (1) Press ▲ or ▼ to select “Signal Booster”, then press (+).
- (2) Make sure “Auto” is selected, then press (+). If the TV signal is too strong (picture distorted; picture with lines; signal interference), select “Off”, press (+) and go to next step to adjust the “Sensitivity”.

**6** If the TV signal is too strong (picture distorted; picture with lines; signal interference), you may be able to adjust the TV reception sensitivity by setting the “Sensitivity” feature.

- (1) Press ▲ or ▼ to select “Sensitivity”, then press (+).
- (2) Press ▲ or ▼ to select “Low”, then press (+).

### Note

- “Sensitivity” is only selectable when “Signal Booster” is set to “Off”.

# ■ Changing the “Setup” setting

The “Setup” menu allows you to change the menu language, adjust the convergence, setup WEGA Theatre Mode, adjust suitable picture setting for video games, label the connected equipment, select the color system, reduce your projection TV power consumption, select the S video input mode and reset your projection TV to factory settings.

**1** Press WEGA GATE and select “Settings”.

**2** Press  $\uparrow$  or  $\downarrow$  to select the “Setup” icon (  ), then press  $\oplus$ .

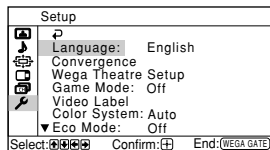

**3** Press  $\uparrow$  or  $\downarrow$  to select the desired item (e.g., “Language”), then press  $\oplus$ .

Select	To
“Language”	change the menu language. Press $\uparrow$ or $\downarrow$ to select either “English”, “中文” (Chinese), “عربي” (Arabic) or “ไทย” (Thai), then press $\oplus$ .
“Convergence”	adjust the convergence. Press $\uparrow$ or $\downarrow$ to select “Digital Quick Focus” or “Manual Adjust”, then press $\oplus$ . When you select “Digital Quick Focus”, convergence is automatically adjusted. When you select “Manual Adjust”, the cross pattern appears on the screen. (1) Press $\uparrow, \downarrow, \leftarrow$ or $\rightarrow$ to adjust the red lines until they converge with the green lines, then press $\oplus$ . (2) Press $\uparrow, \downarrow, \leftarrow$ or $\rightarrow$ to adjust the blue lines until they converge with the center cross pattern, then press $\oplus$ .
“WEGA Theatre Setup”	setup WEGA Theatre Mode for best picture, sound and surround effect enjoyment of a cinema (see page 13). Press $\uparrow$ or $\downarrow$ to select “Direct Input”, then press $\oplus$ . Select either “Video 1”, “Video 2”, “Video 3”, “Video 4”, “HD/DVD 1” or “HD/DVD 2” for the connected equipment that you want to view with WEGA Theatre, then press $\oplus$ . Select “Speaker” and press $\oplus$ . Normally select “MAIN”. When you want to use the projection TV’s speakers as the center speaker, press $\uparrow$ or $\downarrow$ to select “CENTER IN”, then press $\oplus$ .
“Game Mode”	adjust the picture setting that is suitable to view video games. Press $\uparrow$ or $\downarrow$ to select “On”, then press $\oplus$ . To cancel, select “Off”, then press $\oplus$ .

continue

---

## continued

---

"Video Label"	label the connected equipment. (1) Press <b>▲</b> or <b>▼</b> to select the input you want to label, then press <b>⊕</b> . (2) Press <b>▲</b> or <b>▼</b> to select the label options: "Video 1"/"Video 2"/"Video 3"/"Video 4"/"HD/DVD 1"/"HD/DVD 2", "VCR", "SAT", "Game" or "Edit"*, then press <b>⊕</b> . * You may edit the video label to your favorite name. Press <b>▲</b> or <b>▼</b> to select alphanumeric characters for the label, then press <b>⊕</b> .
"Color System"	select the color system. Press <b>▲</b> or <b>▼</b> to select either "Auto", "PAL", "SECAM", "NTSC3.58" or "NTSC4.43", then press <b>⊕</b> . Normally, set this to "Auto".
"Eco Mode"	reduce power consumption of your projection TV to save energy. Press <b>▲</b> or <b>▼</b> to select "On", then press <b>⊕</b> . When you press <b>⊕</b> or turn on the projection TV, Eco Mode ( <b>ECO</b> ) symbol will appear on the screen for a while.  To cancel, select "Off", then press <b>⊕</b> .
"S Input"	select the S video input mode.  Press <b>▲</b> or <b>▼</b> to select "Auto" to receive the S video signal automatically when the signals are input through both the <b>⊕</b> (S video input) and <b>⊕</b> (video input) jacks of the same video input channel, then press <b>⊕</b> .  To cancel, select "Off", then press <b>⊕</b> .
"Factory Settings"	reset your projection TV to factory settings. Press <b>⊕</b> and press <b>▲</b> or <b>▼</b> to select "Yes", then press <b>⊕</b> .  To cancel, select "No", then press <b>⊕</b> .

---

### Tip

- When the Digital Quick Focus feature is performed, manual adjustment values are erased.

### Notes

- Adjust convergence about 20 - 30 minutes after the projection TV is first turned on.
- "Game Mode" is available only when receiving signals through the **⊕** (video input), **⊕** (S video input) or **⊕** (component video input) terminals.
- When HD (high-definition) or progressive signals are input, "Game Mode" does not function.

## ■ Connecting optional components

### Connecting to the video input terminal ( → )

Projection TV drop-down panel

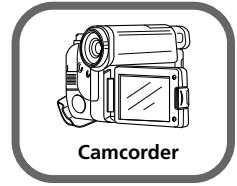
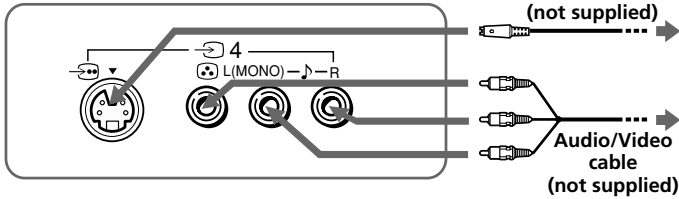

Projection TV rear panel

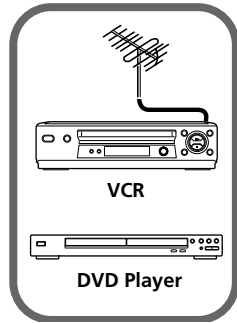
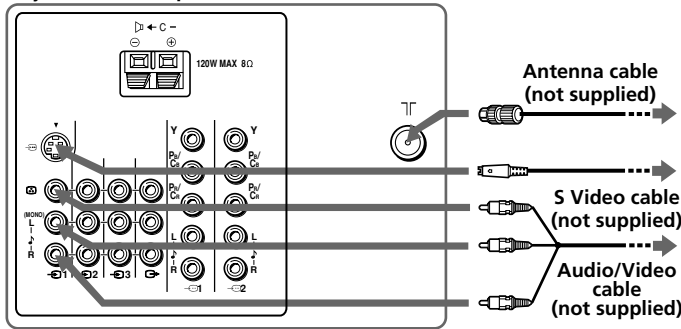

#### Notes

- If you connect a VCR to  $\nabla$  (antenna input), preset the signal output from the VCR to the program number 0 on the projection TV (see page 26).
- When both  $\rightarrow$  (S video) and  $\rightarrow$  (video) for  $\rightarrow$ 1 or  $\rightarrow$ 4 are connected at the same time,  $\rightarrow$  (S video) is automatically selected. To view  $\rightarrow$  (video), disconnect the S video cable.

### Connecting to the monitor output terminal ( → )

Projection TV rear panel

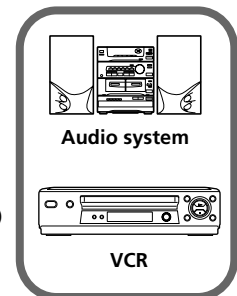
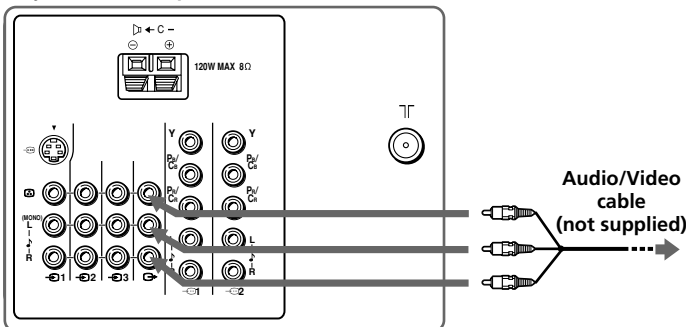

continue

**continued**

## Connecting to the component video input terminal ( )

Projection TV rear panel

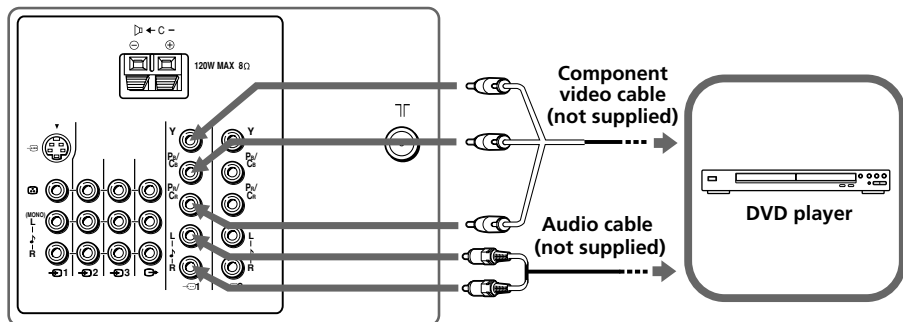

### Notes

- The component video terminals on your DVD player are sometimes labeled Y/C<sub>b</sub>/C<sub>r</sub>, Y/P<sub>b</sub>/P<sub>r</sub>, Y/C<sub>b</sub>/C<sub>r</sub> or Y/B-Y/R-Y.
- If you select “HD/DVD 1” or “HD/DVD 2” on your projection TV screen, the signal from the (monitor output) terminals will not be output properly. This does not indicate a malfunction.

Projection TV rear panel

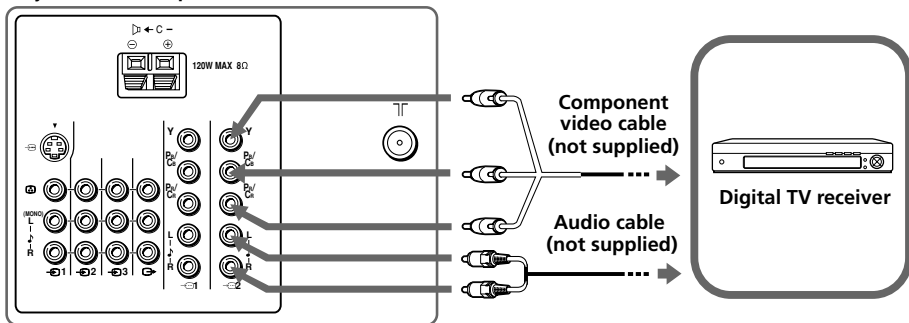

### Note

- If your DTV receiver is equipped with the Y/P<sub>b</sub>/P<sub>r</sub> output terminals, connect it to the Y/P<sub>b</sub>/P<sub>r</sub> terminals of ( ) 1 (component video input 1) or ( ) 2 (component video input 2).

### Tip

- The TV accepts the following signal formats:

Total scanning line	Effective scanning line	fV (Hz)
1125i	1080i	50/60
750p	720p	50/60
625p	576p	50
625i	576i	50
525p	480p	60
525i	480i	60

## Connecting an amplifier to the center speaker input terminal ( $\triangleright \leftarrow C -$ )

If you use an amplifier with a Dolby\* surround decoder instead of the projection TV's audio system, you can use the projection TV's speakers as the center speaker for your audio system.

Using the speaker cords supplied with the amplifier, connect the center speaker terminals of the amplifier to the  $\triangleright \leftarrow C -$  (center speaker input) terminals on the projection TV.

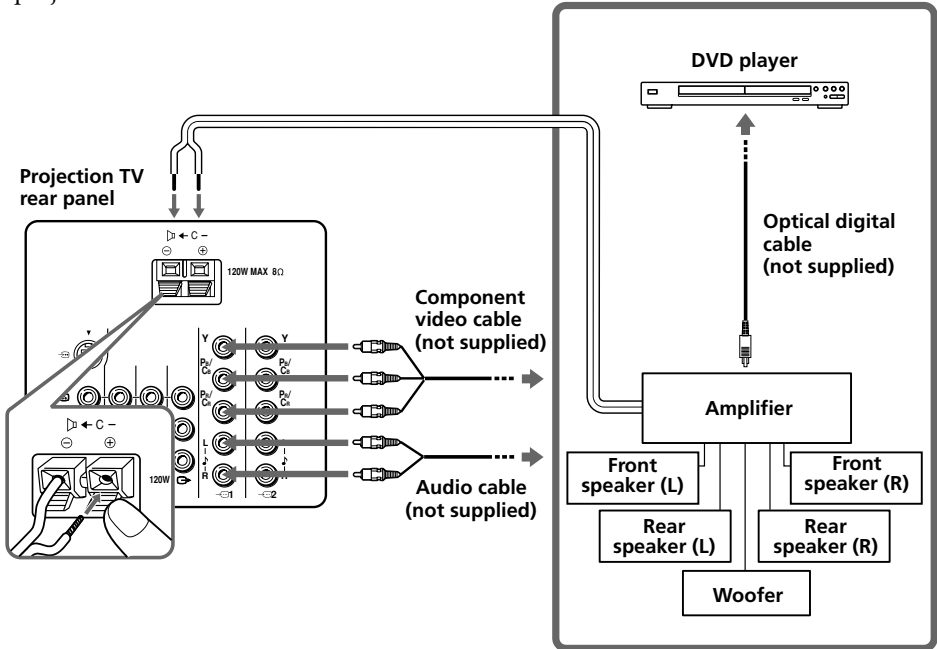

### Note

- If you use the projection TV's speaker as the center speaker and nothing is connected to the center speaker input terminals on the rear of projection TV or the sound source emitted from the amplifier does not contain the center speaker channel, no sound will be heard from the projection TV's speaker.

\* "Dolby" is a trademark of Dolby Laboratories.

# ■ Troubleshooting







If you find any problem while viewing your projection TV, you can either use the "Factory Settings" function or check the Troubleshooting guide below. If the problem persists, contact your Sony dealer.

## "Factory Settings" function

Press the WEGA GATE button. Choose "Settings" and go to "Setup" (🔧) menu.

From "Setup" menu, select "Factory Settings". Then select "Yes" and press (+).

Your projection TV will go blank for a few seconds, then the "Initial Setup" menu will appear. Your projection TV will be set to factory settings, but certain problems may be solved.

Symptom	Solutions
<b>Snowy picture, noisy sound</b>	<ul style="list-style-type: none"> <li>• Check the antenna cable and connection on the projection TV, VCR and at the wall (see page 29).</li> <li>• Check the antenna setup. Contact a Sony dealer for advice.</li> <li>• Display the "Channel Setup" menu and select "Manual Program" to preset the channel again (see page 26).</li> <li>• Display the "Channel Setup" menu and set the "Signal Booster" to "Auto" from "Manual Program" (see page 26).</li> <li>• Try using an external booster.</li> </ul>
<b>Distorted picture, noisy sound</b>	<ul style="list-style-type: none"> <li>• Turn off or disconnect the external booster if it is in use.</li> <li>• Display the "Channel Setup" menu and set the "Sensitivity" to "Low" from "Manual Program" (see page 26).</li> </ul>
<b>Good picture, noisy sound</b>	<ul style="list-style-type: none"> <li>• Display the "Channel Setup" menu and select the appropriate "TV System" from "Manual Program" (see page 26).</li> <li>• The sound of the right picture is selected when twin pictures are displayed. Press  or  once (KP-FR53M94 only) (see page 14).</li> </ul>
<b>No picture, no sound</b>	<ul style="list-style-type: none"> <li>• Check the power cord, antenna and VCR connections (see page 29).</li> <li>• Press I/⏻ (power) to turn on the projection TV (see page 10).</li> <li>• Press ⏻ (main power) on the projection TV to turn off the projection TV for about five seconds, then turn it on again (see page 9).</li> </ul>
<b>Good picture, no sound</b>	<ul style="list-style-type: none"> <li>• Press  + to increase the volume level (see page 9).</li> <li>• Press  to cancel the muting (see page 10).</li> <li>• The sound of the right picture is selected when twin pictures are displayed. Press  or  once (KP-FR53M94 only) (see page 14).</li> <li>• Display the "Sound" menu and select the appropriate setting for "Center Speaker" (see page 22).</li> </ul>
<b>Dotted lines or stripes</b>	<ul style="list-style-type: none"> <li>• Do not use a hair dryer or other equipment near the projection TV.</li> <li>• Check the antenna setup. Contact a Sony dealer for advice.</li> </ul>
<b>Double images or "ghosts"</b>	<ul style="list-style-type: none"> <li>• Use the fine tuning ("Fine") function (see page 26).</li> <li>• Check the antenna setup. Contact a Sony dealer for advice.</li> <li>• Turn off or disconnect the external booster if it is in use.</li> </ul>
<b>No color</b>	<ul style="list-style-type: none"> <li>• Display the "Picture" menu and select "Custom" of "Picture Mode", then adjust the "Color" level in "Picture Adjustment" (see page 21).</li> <li>• Display the "Setup" menu and check the "Color System" setting (usually set this to "Auto") (see page 28).</li> <li>• Check the antenna setup. Contact a Sony dealer for advice.</li> </ul>



Symptom	Solutions
<b>Abnormal color patches</b>	<ul style="list-style-type: none"> <li>• Keep external speakers or other equipment away from the projection TV. Do not move the projection TV while the projection TV is turned on.</li> </ul>
<b>TV cannot receive stereo broadcast sound.</b> or <b>Stereo broadcast sound switches on and off or is distorted.</b>	<ul style="list-style-type: none"> <li>• Check the antenna cable and connection on the projection TV, VCR and at the wall (see page 29).</li> <li>• Check the antenna setup. Contact a Sony dealer for advice.</li> </ul>
<b>The ⏻ (standby) indicator on your projection TV flashes red several times after every three seconds.</b>	<ul style="list-style-type: none"> <li>• Count the number of times the ⏻ (standby) indicator flashes. Press ⏻ (main power) to turn off your projection TV. Contact your nearest Sony service center.</li> </ul>
<b>The projection TV screen sometimes goes blank for slightly longer than usual during channel change.</b>	<ul style="list-style-type: none"> <li>• The “Signal Booster” is functioning to detect a weak signal. This does not indicate a malfunction.</li> </ul>
<b>Cannot play shooting games.</b>	<ul style="list-style-type: none"> <li>• Some shooting games which involve pointing a light beam at the projection TV screen with an electronic gun or rifle cannot be used with your projection TV. For details, see the instruction manual supplied with the video game software.</li> </ul>
<b>Projection TV cabinet creaks.</b>	<ul style="list-style-type: none"> <li>• Change in room temperature sometimes make the projection TV cabinet expand or contract, causing a noise. This does not indicate a malfunction.</li> </ul>
<b>Static discharge is felt when touching the projection TV cabinet.</b>	<ul style="list-style-type: none"> <li>• This is the same static discharge that is felt when touching metal door handles or car doors especially when the air is dry, for example in winter. This does not indicate a malfunction.</li> </ul>
<b>Lines moving across the projection TV screen.</b>	<ul style="list-style-type: none"> <li>• Use the fine tuning (“Fine”) function (see page 26).</li> </ul>

# ■ Specifications

	KP-FR53M94	KP-FR43M90
<b>Projection system</b>	3 picture tubes, 3 lenses, horizontal inline system.	
<b>Picture tube</b>	7 inch high-brightness monochrome tubes (6.3 raster size), with optical coupling and liquid cooling system	
<b>Projection lenses</b>	High performance, large-diameter hybrid lens F1.0	
<b>Screen size</b>	53 inches	43 inches
<b>Television system</b>	B/G, I, D/K, M	
<b>Color system</b>	PAL, PAL 60, SECAM, NTSC3.58, NTSC4.43	
<b>Stereo/Bilingual system</b>	NICAM Stereo/Bilingual B/G, I, D/K A2 Stereo/Bilingual B/G	
<b>Channel coverage</b>		
<b>B/G</b>	VHF : E2 to E12 /UHF : E21 to E69 /CATV : S01 to S03, S1 to S41	
<b>I</b>	UHF : B21 to B68 /CATV : S01 to S03, S1 to S41	
<b>D/K</b>	VHF : C1 to C12, R1 to R12 /UHF : C13 to C57, R21 to R60 / CATV : S01 to S03, S1 to S41, Z1 to Z39	
<b>M</b>	VHF : A2 to A13 /UHF : A14 to A79 / CATV : A-8 to A-2, A to W+4, W+6 to W+84	
<b>⌚ (Antenna)</b>	75-ohm external terminal	
<b>Audio output (Speaker)</b>	15 W + 15 W	
<b>Number of terminal</b>		
📺 (Video)	Input: 4    Output: 1	Phono jacks; 1 Vp-p, 75 ohms
🎵 (Audio)	Input: 6    Output: 1	Phono jacks; 500 mVrms
📺 (S Video)	Input: 2	Y: 1 Vp-p, 75 ohms, unbalanced, sync negative C: 0.286 Vp-p, 75 ohms
📺 (Component Video)	Input: 2	Phono jacks; Y: 1 Vp-p, 75 ohms, sync negative P <sub>B</sub> /C <sub>B</sub> : 0.7 Vp-p, 75 ohms P <sub>R</sub> /C <sub>R</sub> : 0.7 Vp-p, 75 ohms
🔊 (Center Speaker)	Input: 1	120 W max., 8 ohms
🎧 (Headphone)	Output: 1	Stereo minijack
<b>Power requirements</b>	110-240 V AC, 50/60 Hz	
<b>Power consumption (W)</b>	250 W	
<b>Dimensions (w/h/d, mm)</b>	1136 × 1435 × 666	926 × 1255 × 537
<b>Mass (kg)</b>	73	56

Design and specifications are subject to change without notice.