

Trinitron Color TV

เครื่องรับโทรทัศน์ Trinitron

Operating Instructions

GB

- Before operating the unit, please read this manual thoroughly and retain it for future reference.

คู่มือการใช้งาน

ไทย

- ก่อนเริ่มการใช้งานกรุณาอ่านคู่มือนี้โดยละเอียดทั้งหมดและเก็บรักษาคู่มือไว้สำหรับอ้างอิงในโอกาสต่อไป

WEGA

KV-SR292

WARNING

- Dangerously high voltages are present inside the TV.
- TV operating voltage: 220 – 240 V AC.
- Do not plug in the power cord until you have completed making all other connections; otherwise a minimum leakage current might flow through the antenna and other terminals to ground.
- To avoid battery leakage and damage to the remote, remove the batteries from the remote if you are not going to use it for several days. If any liquid leaks from the batteries and touches your skin, immediately wash it away with water.







 <p>For your own safety, do not touch any part of the TV, the power cord and the antenna cable during lightning storms.</p>	 <p>For children's safety, do not leave children alone with the TV. Do not allow children to climb onto it.</p>	 <p>To prevent fire or shock hazard, do not expose the TV to rain or moisture.</p>
 <p>Do not place any objects on the TV. The apparatus shall not be exposed to dripping or splashing and that no objects filled with liquids, such as vases, shall be placed on the apparatus.</p>	 <p>Do not operate the TV if any liquid or solid object falls into it. Have it checked immediately by qualified personnel only.</p>	 <p>Install the TV on a stable TV stand and floor which can support the TV set weight. Ensure that the TV stand surface is flat and its area is larger than the bottom area of the TV.</p>
 <p>Do not block the ventilation openings of the TV. Do not install the TV in a confined space, such as a bookcase or built-in cabinet.</p>	 <p>Your TV is recommended for home use only. Do not use the TV in any vehicle or where it may be subject to excessive dust, heat, moisture or vibrations.</p>	 <p>Do not plug in too many appliances to the same power socket. Do not damage the power cord.</p>
 <p>Do not open the cabinet and the rear cover of the TV as high voltages and other hazards are present inside the TV. Refer servicing and disposal of the TV to qualified personnel.</p>	 <p>Clean the TV with a dry and soft cloth. Do not use benzine, thinner, or any other chemicals to clean the TV. Do not attach anything (e.g., adhesive tape, cellophane tape, glue) on the painted cabinet of the TV. Do not scratch the picture tube.</p>	 <p>Pull the power cord out by the plug. Do not pull the power cord itself. Even if your TV is turned off, it is still connected to the AC power source (mains) as long as the power cord is plugged in. Unplug the TV before moving it or if you are not going to use it for several days.</p>

Table of Contents

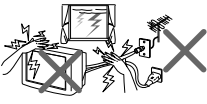
Installation

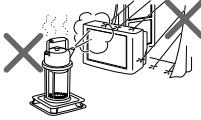
Securing the TV	4
Getting Started	5
Setting up your TV ("Initial Setup")	6

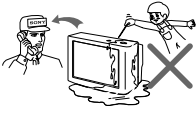
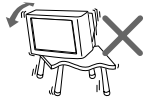
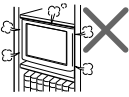
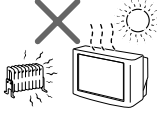
Overview of Controls

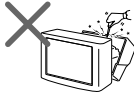
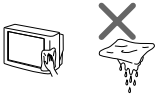
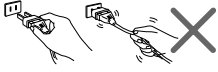
TV front and rear panels	8
Using the remote control and basic functions	9

Advanced Operations

Selecting the picture and sound modes	11
Enjoying the Party Mode	12
Listening to the FM Radio	13
Enjoying stereo or bilingual programs	14

Menu Adjustment

Introducing the WEGA GATE navigator	15
"Settings" Adjustment	16
Changing the "Picture" setting	17
Changing the "Sound" setting	18
Changing the "Channel Setup" setting	19
Changing the "Setup" setting	21

Additional Information

Connecting the 3D WOOFER	22
Connecting optional components ...	22
Troubleshooting	25
Specifications	27

GB

■ Securing the TV

To prevent the TV from falling, use the supplied screws, clamps and band to secure the TV.

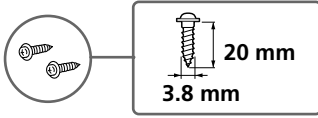

screws



clamps

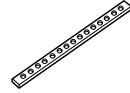

band

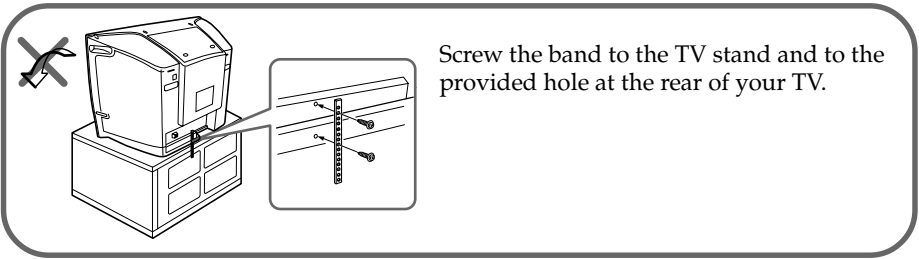

Screw the band to the TV stand and to the provided hole at the rear of your TV.

or

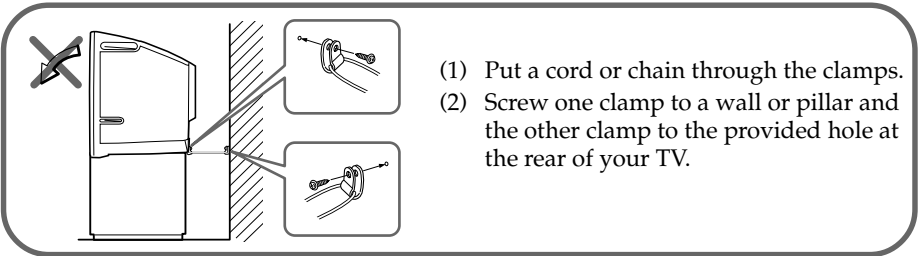

- (1) Put a cord or chain through the clamps.
- (2) Screw one clamp to a wall or pillar and the other clamp to the provided hole at the rear of your TV.

or

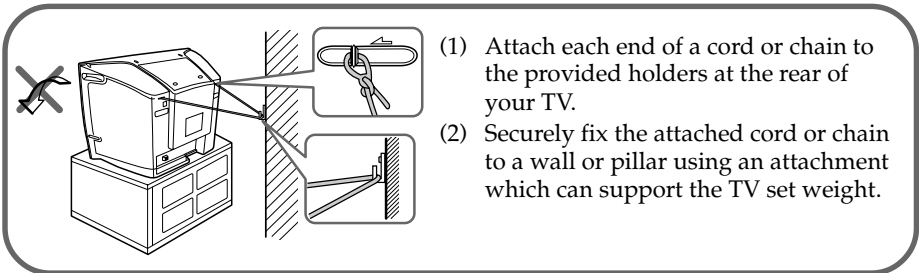

- (1) Attach each end of a cord or chain to the provided holders at the rear of your TV.
- (2) Securely fix the attached cord or chain to a wall or pillar using an attachment which can support the TV set weight.

Note

- Use only the supplied screws. Use of other screws may damage the TV.

■ Getting Started

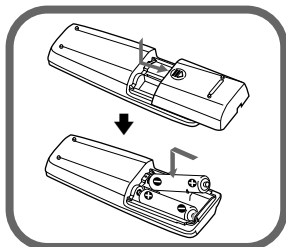

Step 1

Insert the batteries (supplied) into the remote.

Note

- Do not use old or different types of batteries together.

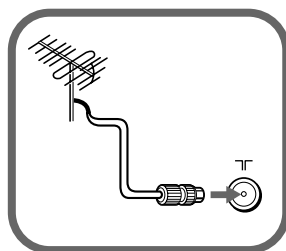

Step 2

Connect the antenna cable (not supplied) to $\overline{\Pi}$ (antenna input) at the rear of the TV.

Tips

- Your TV can receive both TV and FM radio signal from appropriate connections through the $\overline{\Pi}$ (antenna input) terminal (see page 23).
- You can also connect your TV to other optional components (see page 22).

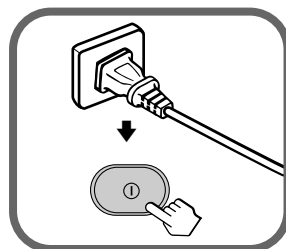

Step 3

Plug in the power cord, then press ⏻ on the TV to turn it on.

Note

- The ⏻ (standby) indicator flashes green for a few seconds when turning on the TV. This does not indicate a malfunction.

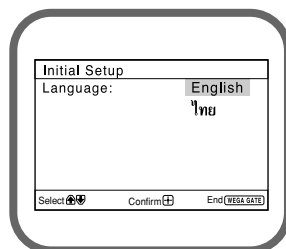

Step 4

Set up the TV by following the instructions of the "Initial Setup" menu (see page 6).

■ Setting up your TV (“Initial Setup”)

When you turn on your TV for the first time, the “Initial Setup” menu will appear. You may change the menu language, preset the TV channels automatically, sort or edit the channels and adjust the picture position using the buttons on the remote control or TV front panel.

- 1** Press **▲** or **▼** to select the desired menu language, then press **[OK]**.

The selected menu language appears.



- 2** Press **▲** or **▼** to select “Yes”, then press **[OK]** to preset the channels automatically.

The screen will indicate automatic presetting is in progress.

After all available channels have been tuned and stored, the “Program Sorting/Edit” menu appears automatically on the screen.

To skip automatic channel presetting, select “No”, then press **[OK]**.

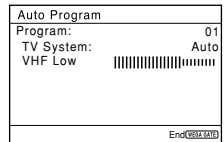
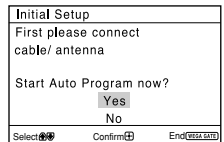

If the message “No channel found. Please connect cable/antenna” appears, check your TV connections, then press **[OK]**.

- 3** The “Program Sorting/Edit” menu enables you to sort and edit the channels.

- If you wish to keep the channels in the current condition, press WEGA GATE to exit.
- Press **▲** or **▼** to select the program number with the channel you wish to change. The selected channel will appear on the screen.
- If you wish to store the channels in a different order:
 - Press **▶** to enter sorting mode.
 - Press **▲** or **▼** to select the new program number position for your selected channel, then press **◀**.

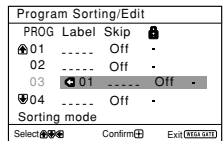
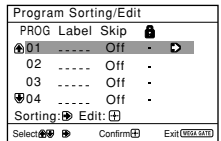

- d) If you wish to edit the channels, press to change to edit mode.

Press until the mode that you wish to edit is highlighted: Label, Skip, (block symbol). Then press .

- 1) To label, press or to select the alphanumeric characters for the label. Then press .
- 2) To skip the program number, press or to select "On". Then press . You can skip this program number when using PROG +/-.
- 3) To block unwanted program number, press or to select . Then press .

- e) Repeat step b) to d) if you wish to change other channels.

Press WEGA GATE to go to the next menu.

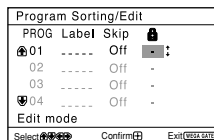
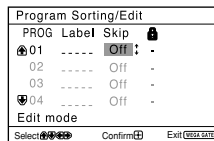
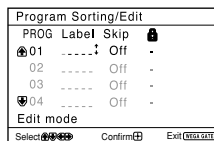

- 4** Press or to adjust the bars on the top and bottom of the menu if they are slanted, then press .

"Picture V-Position" menu appears.

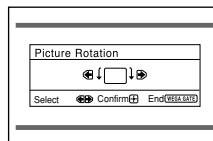

- 5** If the upper and lower bars are not equally positioned to the top and bottom of the screen, press or to adjust them, then press .

If no adjustment is necessary, then press .

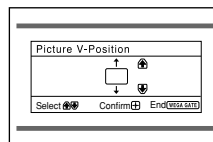

- 6** To prevent this "Initial Setup" menu from appearing again when you turn on the TV by pressing , press or to select "No", then press .

To allow this menu to appear again, select "Yes", then press .

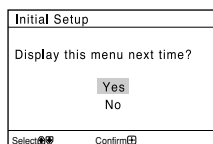

Tip

- You can immediately go to the end of the "Initial Setup" menu by pressing WEGA GATE.

TV front and rear panels

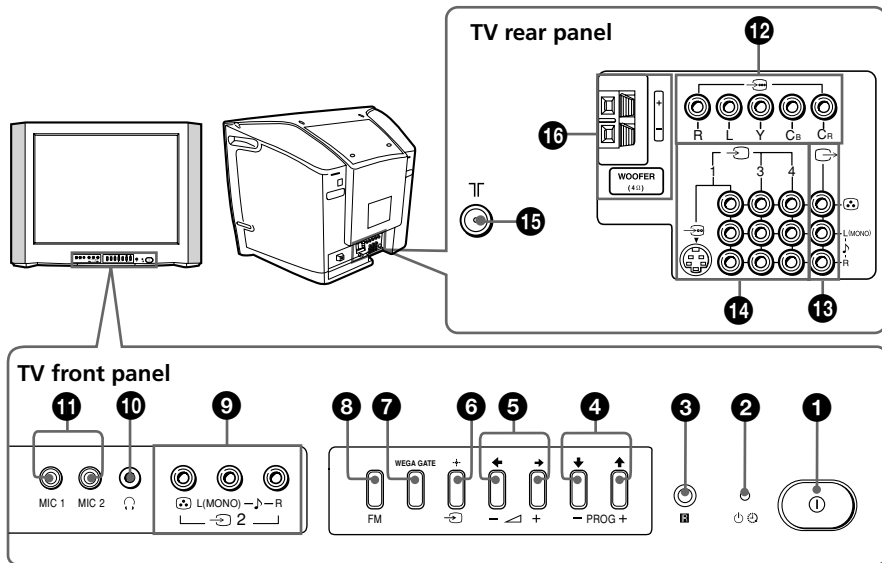

Button/Terminal	Function	Page
① ①	Turn off or turn on the TV.	5
② ①	Standby indicator.	5
② ②	Wake Up indicator.	10
③ ③	Remote control sensor.	-
④ PROG +/-	Select program number.	-
⑤ ④ +/-	Adjust volume.	-
⑥ ⑤	Select TV or video input.	22
WEGA GATE menu operations		
④, ⑤ ④, ⑤, ⑥, ⑦	Select and adjust items.	15
⑥ ⑥	Confirm selected items.	15
⑦ WEGA GATE	Display or cancel WEGA GATE menu.	15
⑧ FM	Listen to FM radio.	13
⑨ ②	Video input terminal 2.	22
⑩ ⑩	Headphone jack.	-
⑪ MIC 1, MIC 2	Microphone input terminal 1, 2.	12
⑫ ⑫	Component video input terminal.	24
⑬ ⑬	Monitor output terminal.	23
⑭ ①, ③, ④	Video input terminal 1, 3, 4.	23
⑮ ⑮	Antenna input terminal.	23
⑯ WOOFER	3D WOOFER terminal.	22



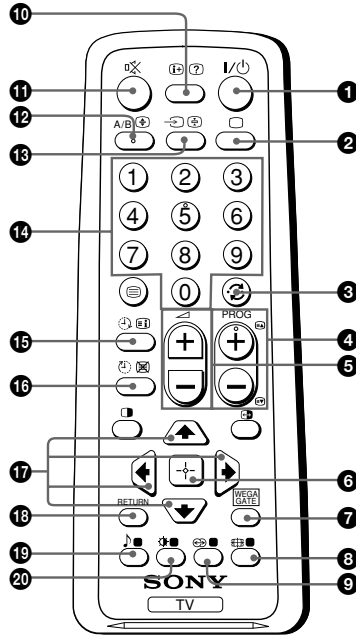



■ Using the remote control and basic functions



Button	Description	Page
1 I/⏻	Turn off temporarily or turn on the TV.	–
2 □	Display the TV program.	–
3 ↺	Jump to last program number that has been watched for at least five seconds.	–
4 PROG +/-	Select program number.	–
5 ▲ +/-	Adjust volume.	–
8 📺	Change the picture size: "On" (16:9 wide mode), "Off".	–
9 ⊞	Select surround mode options.	18
10 i+	Display on-screen information.	–
11 ⏻	Mute the sound.	–
13 ↺	Select TV or video input.	22
14 0 – 9	Input numbers. For program numbers 10 and above, enter the second digit within two seconds.	–
19 🎵	Select sound mode options with a 5-Band Graphic Equalizer display.	11
20 📺	Select picture mode options.	11

continue

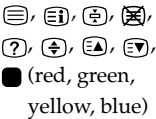
continued

Button	Description	Page
WEGA GATE menu operations		
6 	Confirm selected items.	15
7 WEGA GATE	Display or cancel the WEGA GATE menu.	
17 	Select and adjust items.	
18 RETURN	Return to the previous level	
Timer operations		
15  (Wake up timer)	Set TV to turn on automatically according to the desired period of time (max. of 12 hours). The  indicator on TV lights up amber once you set the wake up timer. If no buttons or controls are pressed for more than one hour after the TV is turned on using the wake up timer, the TV automatically goes into standby mode.	-
16  (Sleep timer)	Set TV to turn off automatically according to the desired period of time (max. of one hour and 30 min.).	-
Teletext operations (green label)		
 (red, green, yellow, blue)	Not function for your TV.	-
PIP operations		
	Not function for your TV.	-
Stereo/bilingual operations		
12 A/B	Select stereo/bilingual mode.	14

WOW, TruSurround, SRS and  symbol are trademarks of SRS Labs, Inc. WOW and TruSurround technologies are incorporated under license from SRS Labs, Inc.

Licensed by BBE Sound, Inc. under USP4638258, 4482866.
"BBE" and BBE symbol are trademarks of BBE Sound, Inc.

■ Selecting the picture and sound modes

You can select picture and sound modes and adjust the setting to your preference in the “Custom” option.

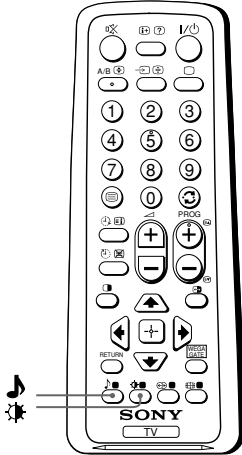

Selecting the picture mode

Press  to select the desired picture mode.

Select	To view
“Vivid”	contrast and sharp pictures.
“Standard”	normal pictures.
“Custom”	the last adjusted picture setting from the “Picture Adjustment” option in the menu (see page 17).

Selecting the sound mode



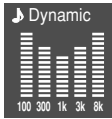
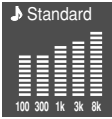
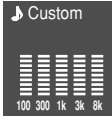





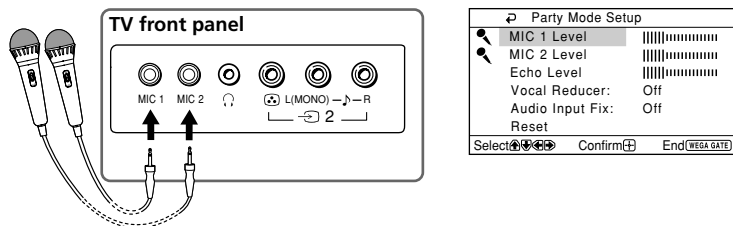

Press  to select the desired sound mode. 5-Band Graphic Equalizer display will appear.

Select	To listen to
“Dynamic” 	dynamic and clear sound that emphasizes both the low and high tones.
“Standard” 	sound that emphasizes voice and high tones.
“Custom” 	the last adjusted sound setting from the “Sound Adjustment” option in the menu (see page 18).

■ Enjoying the Party Mode

You can sing duet along with any music program of TV broadcast or with any audio/video equipment or create visual presentations (e.g., photos or video stories) with narration and favorite background music by using the Party Mode feature.



- 1** Select the input connected to your audio/video equipment.
- 2** Connect the microphone (not supplied) to the microphone input terminal and switch it on.
You can begin singing or speaking from the microphone at the last TV volume setting. You can press A/B button on remote control to switch between left ("L") or right ("R") channel sound for VCD karaoke source only (either music or vocal) when video input is selected and "Audio Input Fix" is set to "Off".
- 3** Press WEGA GATE and select "Party Mode".
- 4** Select "MIC 1 Level", "MIC 2 Level" or "Echo Level", then press . Press , , , or  to adjust the microphone volume and echo level of the microphone sound, then press .
- 5** If you want to reduce the vocal of the singer or speaker, select "On" from "Vocal Reducer" and press  (effective for non-karaoke stereo source only).
- 6** Select "Audio Input Fix" and press , then press  or  to select the input connected to the audio equipment from which you want to hear the sound: "Video 1", "Video 2", "Video 3", "Video 4" or "DVD".
To revert to the original sound source, select "Off", then press .
- 7** Selecting "Reset" will set your TV to the factory settings (except for "Audio Input Fix").

Tip

- Microphone volume will be affected by TV volume.

Notes

- Be sure to adjust the microphone and echo level to the minimum level before plugging in and disconnecting the microphone.
- For your own safety, do not use or plug in the microphone during lightning storms.
- Keep microphone away from the speakers and adjust its volume to avoid acoustic feedback (howling) and distortion.
- Vocal Reducer will set to "Off" if you select "L" or "R" channel sound.

■ Listening to the FM Radio

You are able to listen to the FM radio stations using your TV.

To access to FM Radio mode:

Press WEGA GATE button and select “FM Radio” (see page 15).

or

Press FM button on the front panel (see page 8).

To exit from FM Radio mode:

Press WEGA GATE button, select the desired items: “TV” or “External Inputs”, then press $\left[\begin{smallmatrix} + \\ - \end{smallmatrix} \right]$. Select the desired TV channel or external inputs and press $\left[\begin{smallmatrix} + \\ - \end{smallmatrix} \right]$.

or

Press FM button on the front panel.

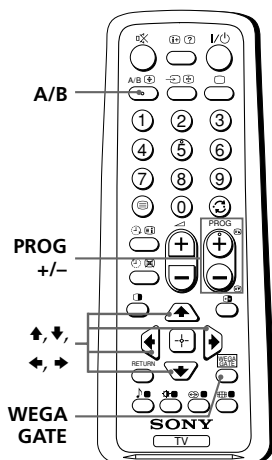

Listening to preset stations

1 Access to FM Radio mode.

2 Press WEGA GATE button and select “Settings”.
Preset the desired FM radio stations in “FM Radio Setup” from “Channel Setup” menu (see page 19).

3 Exit from “Channel Setup” menu by pressing WEGA GATE button. The selected preset FM radio station number and label will appear on the screen. To select the desired preset FM radio station, press PROG +/-.

Tip

- You can also use the 1-9 buttons on the remote control to directly select the desired preset FM radio station.

Listening to non-preset stations

1 Access to FM Radio mode.

2 Press \uparrow or \downarrow to search for the desired FM radio station. The preset number and label will not be displayed.

3 If the station has a weak signal, press \leftarrow or \rightarrow to fine tune the radio frequency manually.

Notes

- You can only operate \uparrow , \downarrow , \leftarrow and \rightarrow functions using the remote control buttons in FM Radio mode.
- The available radio frequency is only for temporary listening pleasure and cannot be stored in the memory.
- If the message “Please setup FM Radio” appears, display the “Channel Setup” menu and select “FM Radio Setup” to preset the desired FM radio stations (see page 19).

Note

- When a FM stereo program has static noise, press A/B until “Mono” appears. There will be no stereo effect, but the noise will be reduced.

Enjoying stereo or bilingual programs

You can enjoy stereo sound or bilingual programs of NICAM and A2 stereo systems by using the A/B button.

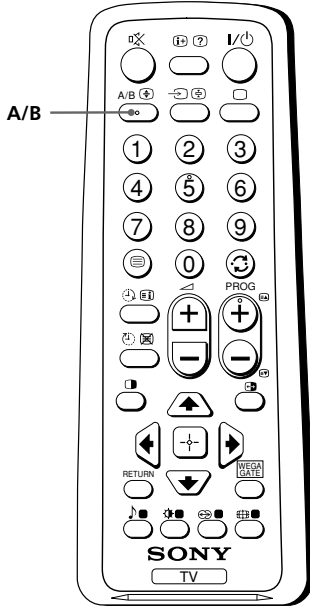

When receiving a NICAM program

Broadcasting	On-screen display (Selected sound)	
NICAM stereo	NICAM (Stereo sound)	Mono (Regular sound)
NICAM bilingual	NICAM Main (Main sound)	NICAM Sub (Sub sound)
NICAM monaural	NICAM Main (Main sound)	Mono (Regular sound)

When receiving an A2 program

Broadcasting	On-screen display (Selected sound)	
A2 stereo	Stereo (Stereo sound)	Mono (Regular sound)
A2 bilingual	Main (Main sound)	Sub (Sub sound)

Note

- If the stereo sound is noisy when receiving a stereo program, select “Mono”. The sound becomes monaural but the noise is reduced.

Introducing the WEGA GATE navigator

WEGA GATE is a gateway that allows you access to preset TV channels, connected external inputs, FM Radio mode, Party Mode and "Settings" menu.

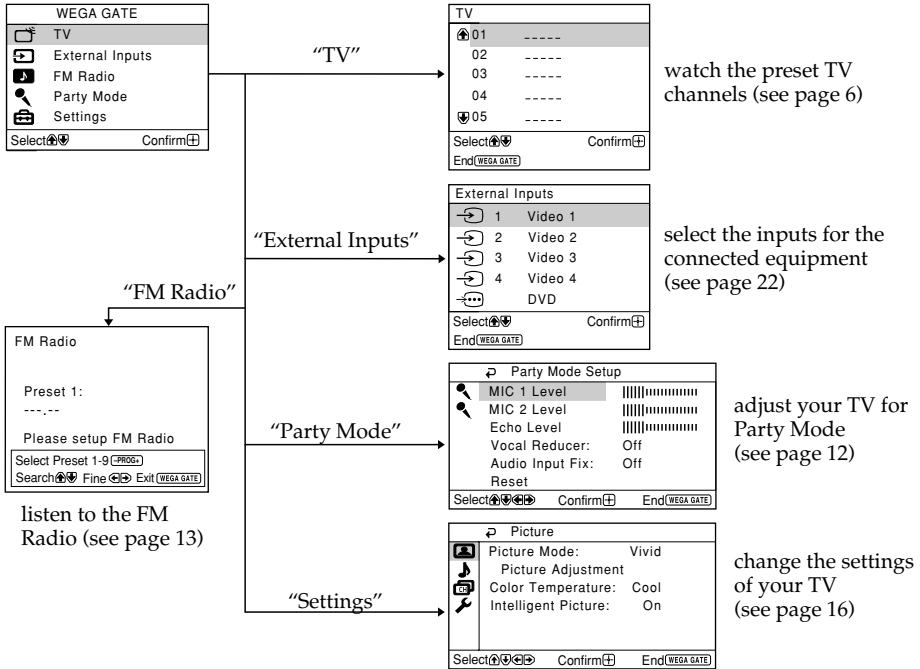

How to use WEGA GATE

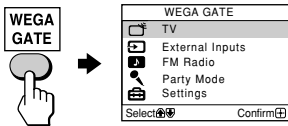

(1) Press WEGA GATE to display or cancel the WEGA GATE menu.

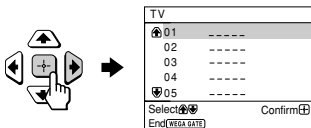

(2) Press \rightarrow (or \leftarrow) to confirm your selection or go to the next level.

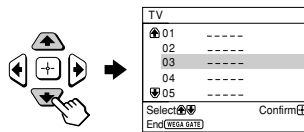

(3) Press \uparrow or \downarrow to select the desired item.

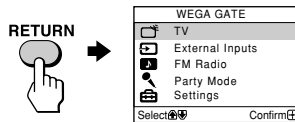

(4) Press RETURN to move to the previous level.

Tip

- The WEGA GATE, \leftarrow , \rightarrow , \uparrow , \downarrow , \leftarrow , \rightarrow buttons on the front panel can also be used for the operations above.

Settings Adjustment

You are able to change the settings of your TV from "Settings" in WEGA GATE menu.

Press WEGA GATE button to display WEGA GATE menu. Press \blacktriangle or \blacktriangledown to select "Settings" and press $\left[\begin{smallmatrix} \blacktriangle \\ \blacktriangledown \end{smallmatrix} \right]$.

The following is an overview of the items that can be adjusted.

Picture	
	Picture Mode: Vivid
	Picture Adjustment
	Color Temperature: Cool
	Intelligent Picture: On
Select $\left[\begin{smallmatrix} \blacktriangle \\ \blacktriangledown \end{smallmatrix} \right]$	Confirm $\left[\begin{smallmatrix} \oplus \\ \ominus \end{smallmatrix} \right]$ End (WEGA GATE)

"Picture" (see page 17)

"Picture Mode": "Vivid" \rightarrow "Standard" \rightarrow "Custom"

"Picture Adjustment": "Picture", "Brightness", "Color", "Hue", "Sharpness", "Reset"

"Color Temperature": "Cool" \rightarrow "Neutral" \rightarrow "Warm"

"Intelligent Picture": "On" \rightarrow "Off"

Sound	
	Sound Mode: Dynamic
	Sound Adjustment
	Balance
	Intelligent Volume: Off
	Surround: Off
Select $\left[\begin{smallmatrix} \blacktriangle \\ \blacktriangledown \end{smallmatrix} \right]$	Confirm $\left[\begin{smallmatrix} \oplus \\ \ominus \end{smallmatrix} \right]$ End (WEGA GATE)

"Sound" (see page 18)

"Sound Mode": "Dynamic" \rightarrow "Standard" \rightarrow "Custom"

"Sound Adjustment": "Adjust", "Reset"

"Balance"

"Intelligent Volume": "On" \rightarrow "Off"

"Surround": "TruSurround" \rightarrow "WOW" \rightarrow "Simulated" \rightarrow "Off"

Channel Setup	
	Auto Program
	Manual Program
	Program Sorting/Edit
	FM Radio Setup
Select $\left[\begin{smallmatrix} \blacktriangle \\ \blacktriangledown \end{smallmatrix} \right]$	Confirm $\left[\begin{smallmatrix} \oplus \\ \ominus \end{smallmatrix} \right]$ End (WEGA GATE)

"Channel Setup" (see page 19)

"Auto Program"

"Manual Program"

"Program": "00" - "99"

"TV System": "B/G" \rightarrow "I" \rightarrow "D/K" \rightarrow "M"

"VHF Low" / "VHF High" / "UHF"

"Fine": "Auto" \rightarrow "Manual"

"Signal Booster": "Auto" \rightarrow "Off"

"Program Sorting/Edit"

"FM Radio Setup"

Setup	
	Language: English
	Picture Position
	Video Label
	Color System: Auto
	Factory Settings
Select $\left[\begin{smallmatrix} \blacktriangle \\ \blacktriangledown \end{smallmatrix} \right]$	Confirm $\left[\begin{smallmatrix} \oplus \\ \ominus \end{smallmatrix} \right]$ End (WEGA GATE)

"Setup" (see page 21)

"Language": "English" \rightarrow "ไทย" (Thai)

"Picture Position": "Picture Rotation", "Picture V-Position"

"Video Label": "Video Input", "Label"

"Color System": "Auto" \rightarrow "PAL" \rightarrow "SECAM" \rightarrow "NTSC3.58" \rightarrow "NTSC4.43"

"Factory Settings": "Yes" \rightarrow "No"

Note

- When a feature is dimmed in the menu, it is not selectable.

■ Changing the “Picture” setting

The “Picture” menu allows you to adjust the picture settings.

1 Press WEGA GATE and select “Settings”.

2 Make sure the “Picture” icon (🖼️) is selected, then press [↔️].

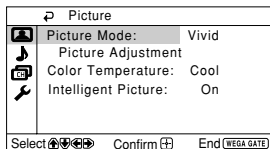

3 Press ↑ or ↓ to select the desired item (e.g., “Picture Mode”), then press [↔️].

Select	To
“Picture Mode”	choose either “Vivid”, “Standard” or “Custom”* (see page 11).
“Color Temperature”	adjust white color tint. Choose either “Cool” (blue tint), “Neutral” (neutral tint) or “Warm” (red tint).
“Intelligent Picture”	optimize picture quality. Press ↑ or ↓ to select “On”, then press [↔️]. To cancel, select “Off”, then press [↔️].

* You can adjust the setting to your personal preference in the “Picture Adjustment” and “Color Temperature” options only when the “Custom” mode is selected.

Adjusting the “Picture Adjustment” items under “Custom” mode

1 Press ↑ or ↓ to select either “Picture” (contrast), “Brightness”, “Color”, “Hue” (color tones) or “Sharpness”, then press [↔️].

Selecting “Reset” will set your TV to the factory settings.

2 Press ↑, ↓, ← or → to adjust the setting of your selected item, then press [↔️].

3 Repeat the above steps to adjust other items.

The adjusted settings will be received when you select “Custom”.



Notes

- “Hue” can be adjusted for the NTSC color system only.
- Reducing “Sharpness” can also reduce picture noise.

■ Changing the “Sound” setting



The “Sound” menu allows you to adjust the sound settings.

1 Press WEGA GATE and select “Settings”.

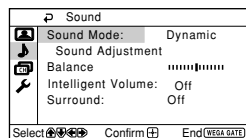
2 Press ↑ or ↓ to select the “Sound” icon (), then press .



3 Press ↑ or ↓ to select the desired item (e.g., “Sound Mode”), then press .

Select	To
“Sound Mode”	choose either “Dynamic”, “Standard” or “Custom”* (see page 11).
“Balance”	Press ↓ or ← to emphasize the left speaker. Press ↑ or → to emphasize the right speaker.
“Intelligent Volume”	adjust the volume of all program numbers and video inputs automatically. Press ↑ or ↓ to select “On”, then press  .To cancel, select “Off”, then press  .
“Surround”	choose either “TruSurround” (surround sound that spreads out to the rear of a room), “WOW”** (full, deep bass sound), “Simulated” (stereo-like monaural sound) or “Off”.

* You can adjust the setting to your personal preference in the “Sound Adjustment” option only when the “Custom” mode is selected.

** BBE High Definition Sound is fully activated maximizing the sound effect in WOW mode.

Note

- “Intelligent Volume” is not selectable when “TruSurround” is selected or when the microphone input terminal is connected.

Adjusting the “Sound Adjustment” items under “Custom” mode

The 5-Band Graphic Equalizer feature allows you to adjust sound frequency settings of “Custom” mode in the menu.

1 Make sure that “Adjust” is selected, then press .

Selecting “Reset” will set your TV to the factory settings.

2 Press ← or → to select the desired sound frequency, then press ↑ or ↓ to adjust the setting and press .

The adjusted settings will be received when you select “Custom”.

Notes

- Adjusting higher frequency will affect higher pitched sound and adjusting lower frequency will affect lower pitched sound.
- You may display the settings directly by using the  button on the remote control (see page 9).

■ Changing the “Channel Setup” setting

The “Channel Setup” menu allows you to preset channels automatically, manually preset channels, sort or edit the channels and preset FM radio stations.

1 Press WEGA GATE and select “Settings”.

2 Press \uparrow or \downarrow to select the “Channel Setup” icon (📶), then press (📶).

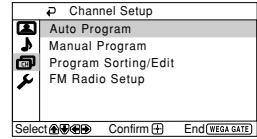

3 Press \uparrow or \downarrow to select the desired item (e.g., “Auto Program”), then press (📶).

Select	To
“Auto Program”	preset channels automatically.
“Manual Program”	manually preset desired channels and channels that cannot be preset automatically (see Presetting channels manually in page 20).
“Program Sorting/Edit”	change the order in which the channels appear on the screen, label the program number, skip the program number and block unwanted programs. (see step 3 of the section “Initial Setup” in page 6).
“FM Radio Setup”*	preset up to nine FM radio stations. You can manually preset each FM radio station that can be received in your area and then store the radio frequency of the desired FM radio stations. (1) Press \uparrow or \downarrow to select the desired FM radio station position, then press (📶). (2) Press \uparrow or \downarrow to search the FM radio stations. Searching stops automatically when a station is tuned in. If the station has a weak signal, press \leftarrow or \rightarrow to fine tune the radio frequency manually, then press (📶) to store the FM radio station. (3) You may edit the FM radio station label. Press \uparrow or \downarrow to select alphanumeric characters for the label, then press (📶). (4) Repeat steps (1) through (3) to preset other FM radio stations. * The “FM Radio Setup” feature is only available in FM Radio mode. To enable this feature, access to FM Radio mode by using WEGA GATE system (see page 15) or pressing the FM button on the front panel (see page 8), then preset your desired FM radio stations according to the steps mentioned above.

Notes





- If you preset a blocked program number, that program number will be unblocked automatically.
- If you sort a blocked program, that program will remain blocked.

continue

continued



Presetting channels manually

1 After selecting “Manual Program”, select the program number to which you want to preset a channel.

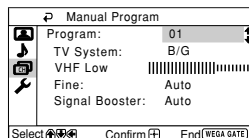





- (1) Make sure “Program” is selected, then press .
- (2) Press  or  until the program number you want to preset appears on the menu, then press .













2 Select the desired channel.

- (1) Make sure either “VHF Low”, “VHF High” or “UHF” is selected, then press .
- (2) Press  or  until the desired channel’s broadcast appears on the TV screen, then press .







3 If the sound of the desired channel is abnormal, select the appropriate TV system.

- (1) Press  or  to select “TV System”, then press .
- (2) Press  or  until the sound becomes normal, then press .

4 If you are not satisfied with the picture and sound quality, you may be able to improve them by using the “Fine” tuning feature.

- (1) Press  or  to select “Fine”, then press .
 - (2) Press  or  to select “Manual”, then press .
 - (3) Press , ,  or  until the picture and sound quality are optimal, then press .
- The + or – icon on the menu flashes while tuning.

5 If the TV signal is too strong (picture distorted; picture with lines; signal interference) or weak (snowy picture), you may be able to improve the picture quality by setting the “Signal Booster” feature.

- (1) Press  or  to select “Signal Booster”, then press .
- (2) Press  or  to select either “Off” (for picture distorted; picture with lines; signal interference) or “Auto” (for snowy picture), then press .

■ Changing the “Setup” setting

The “Setup” menu allows you to change the menu language, adjust the picture position, label the connected equipment, select the color system and reset your TV to factory settings.

1 Press WEGA GATE and select “Settings”.

2 Press \uparrow or \downarrow to select the “Setup” icon (🔧), then press $\left[\begin{smallmatrix} \uparrow \\ \downarrow \end{smallmatrix} \right]$.

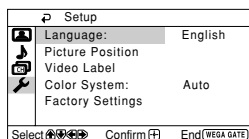

3 Press \uparrow or \downarrow to select the desired item (e.g., “Language”), then press $\left[\begin{smallmatrix} \uparrow \\ \downarrow \end{smallmatrix} \right]$.

Select	To
“Language”	change the menu language. Press \uparrow or \downarrow to select either “English” or “ไทย” (Thai), then press $\left[\begin{smallmatrix} \uparrow \\ \downarrow \end{smallmatrix} \right]$.
“Picture Position”	adjust the picture position when it is not aligned with the TV screen. Press \uparrow or \downarrow to select “Picture Rotation” or “Picture V-Position”, then press $\left[\begin{smallmatrix} \uparrow \\ \downarrow \end{smallmatrix} \right]$. Press \uparrow , \downarrow , \leftarrow or \rightarrow to adjust picture position, then press $\left[\begin{smallmatrix} \uparrow \\ \downarrow \end{smallmatrix} \right]$.
“Video Label”	label the connected equipment. (1) Select “Video Input” and press $\left[\begin{smallmatrix} \uparrow \\ \downarrow \end{smallmatrix} \right]$. Press \uparrow or \downarrow to select the input you want to label, then press $\left[\begin{smallmatrix} \uparrow \\ \downarrow \end{smallmatrix} \right]$. (2) Select “Label” and press $\left[\begin{smallmatrix} \uparrow \\ \downarrow \end{smallmatrix} \right]$, then press \uparrow or \downarrow to select the label options: “Video 1” / “Video 2” / “Video 3” / “Video 4” / “DVD”, “VCR”, “SAT”, “Game” or “Edit”*. * You may edit the video label to your favorite name. Press \uparrow or \downarrow to select alphanumeric characters for the label, then press $\left[\begin{smallmatrix} \uparrow \\ \downarrow \end{smallmatrix} \right]$.
“Color System”	select the color system. Press \uparrow or \downarrow to select “Auto”, “PAL”, “SECAM”, “NTSC3.58” or “NTSC4.43”, then press $\left[\begin{smallmatrix} \uparrow \\ \downarrow \end{smallmatrix} \right]$. Normally, set this to “Auto”.
“Factory Settings”	reset your TV to factory settings. Press $\left[\begin{smallmatrix} \uparrow \\ \downarrow \end{smallmatrix} \right]$ and press \uparrow or \downarrow to select “Yes”, then press $\left[\begin{smallmatrix} \uparrow \\ \downarrow \end{smallmatrix} \right]$. To cancel, select “No”, then press $\left[\begin{smallmatrix} \uparrow \\ \downarrow \end{smallmatrix} \right]$.

Note

- Color system is not selectable in FM Radio mode.

■ Connecting the 3D WOOFER

You can enjoy high quality sound by connecting the 3D WOOFER as follows:

Step 1

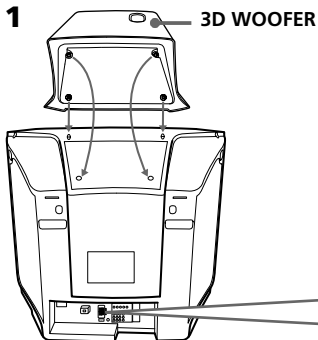

Step 2

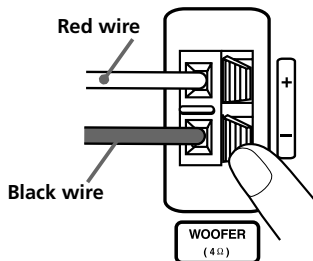

Notes

- Connect only the supplied 3D WOOFER; otherwise your TV may malfunction.
- Unplug your TV from the wall outlet when connecting the 3D WOOFER.
- To prevent a malfunction caused by a short circuit of the terminals, make sure that none of the 3D WOOFER wire strands stick out, making contact with the neighbouring 3D WOOFER terminal.

■ Connecting optional components

Connecting to the video input terminal (→)

TV front panel

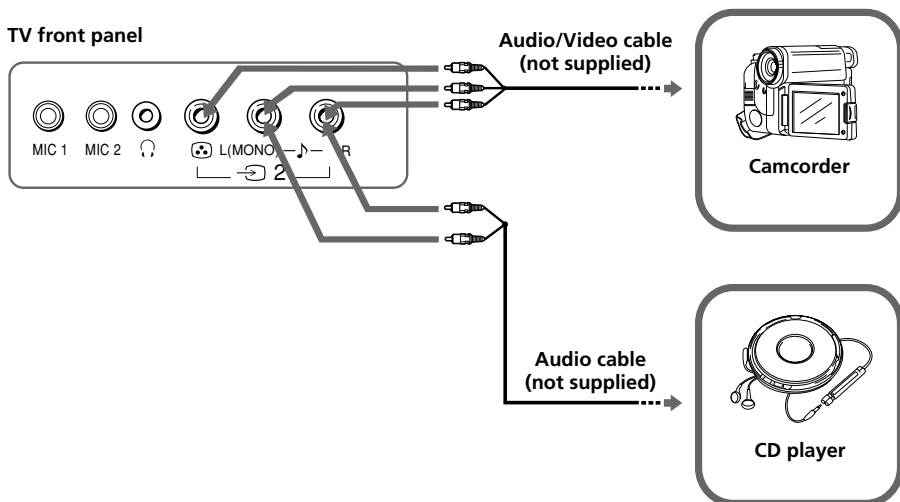

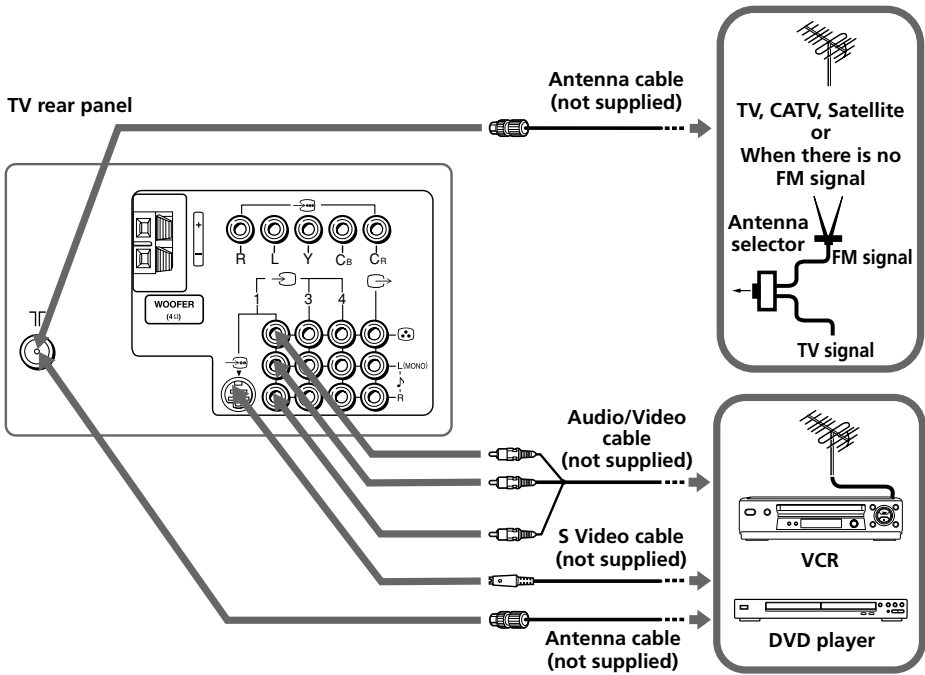

Notes

- If you connect a VCR to (antenna input), preset the signal output from the VCR to the program number 0 on the TV (see page 20).
- When both (S video) and (video) for (video) are connected at the same time, (S video) is automatically selected. To view (video), disconnect the S video cable.

Connecting to the monitor output terminal ()

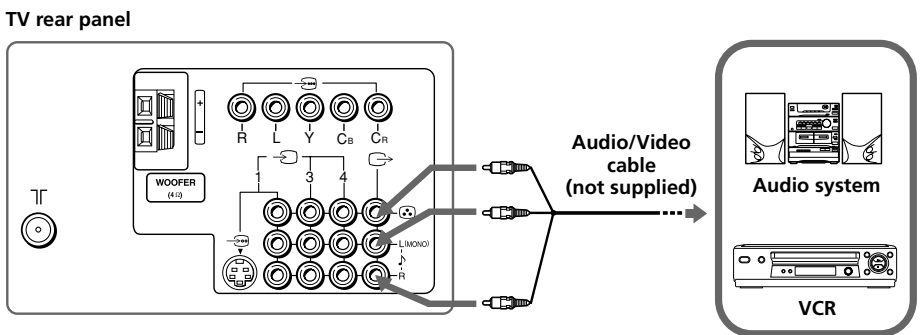

continue



continued

Connecting to the component video input terminal ()

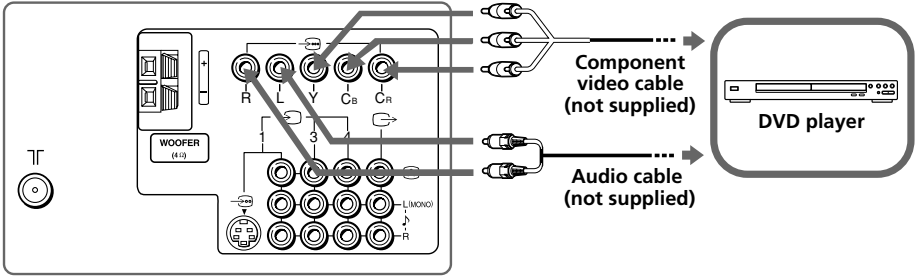
TV rear panel



Notes





- If your DVD player can output interlace and progressive mode signals, select the interlace output when connecting to  (component video input) on your TV. Your TV can receive either 525i/60Hz or 625i/50Hz interlace signals.
- The component video terminals on your DVD player are sometimes labeled Y/Cb/Cr, Y/Pb/Pr, Y/Cb/Cr or Y/B-Y/R-Y.
- If you select "DVD" on your TV screen, the signal from the  (monitor output) jacks will not be output properly. This does not indicate a malfunction.

Troubleshooting

If you find any problem while viewing your TV, you can either use the “Factory Settings” function or check the Troubleshooting guide below. If the problem persists, contact your Sony dealer.

“Factory Settings” function

Press the WEGA GATE button. Choose “Settings” and go to “Setup” (🔧) menu. From “Setup” menu, select “Factory Settings”. Then select “Yes” and press . Your TV will go blank for a few seconds, then the “Initial Setup” menu will appear. Your TV will be set to factory settings, but certain problems may be solved.

Symptom	Solutions
Snowy picture, noisy sound	<ul style="list-style-type: none"> • Check the antenna cable and connection on the TV, VCR and at the wall (see page 23). • Check the antenna setup. Contact a Sony dealer for advice. • Display the “Channel Setup” menu and select “Manual Program” to preset the channel again (see page 20). • Display the “Channel Setup” menu and set the “Signal Booster” to “Auto” from “Manual Program” (see page 20). • Try using an external booster.
Distorted picture, noisy sound	<ul style="list-style-type: none"> • Turn off or disconnect the external booster if it is in use. • Display the “Channel Setup” menu and set the “Signal Booster” to “Off” from “Manual Program”(see page 20).
Good picture, noisy sound	<ul style="list-style-type: none"> • Display the “Channel Setup” menu and select the appropriate “TV System” from “Manual Program” (see page 20).
No picture, no sound	<ul style="list-style-type: none"> • Check the power cord, antenna and VCR connections (see page 23). • Press  (power) to turn on the TV (see page 9). • Press  (main power) on the TV to turn off the TV for about five seconds, then turn it on again (see page 8).
Good picture, no sound	<ul style="list-style-type: none"> • Press  + to increase the volume level (see page 9). • Press  to cancel the muting (see page 9).
No sound or inappropriate sound	<ul style="list-style-type: none"> • Display the WEGA GATE menu and set the “Audio Input Fix” to “Off” from “Party Mode Setup” (see page 12).
Dotted lines or stripes	<ul style="list-style-type: none"> • Do not use a hair dryer or other equipment near the TV. • Check the antenna setup. Contact a Sony dealer for advice.
Double images or “ghosts”	<ul style="list-style-type: none"> • Use a highly directional antenna. • Use the fine tuning (“Fine”) function (see page 20). • Check the antenna setup. Contact a Sony dealer for advice. • Turn off or disconnect the external booster if it is in use.
No color	<ul style="list-style-type: none"> • Display the “Picture” menu and select “Custom” from “Picture Mode”, then adjust the “Color” level from “Picture Adjustment” (see page 17). • Display the “Setup” menu and check the “Color System” setting (usually set this to “Auto”) (see page 21). • Check the antenna setup. Contact a Sony dealer for advice.

continue

continued

Symptom	Solutions
Picture slant	<ul style="list-style-type: none">• Keep external speakers or other electrical equipment away from the TV.• Display the “Picture Position” under “Setup” menu, then adjust “Picture Rotation” and “Picture V-Position” so that the picture is aligned to the TV screen (see page 21).
Abnormal color patches	<ul style="list-style-type: none">• Keep external speakers or other equipment away from the TV. Do not move the TV while the TV is turned on. Press Ⓚ (main power) on the TV to turn off the TV for about 15 minutes, then turn it on again to demagnetize the TV.
TV cannot receive stereo broadcast sound or Stereo broadcast sound switches on and off or is distorted.	<ul style="list-style-type: none">• Check the antenna cable and connection on the TV, VCR and at the wall (see page 23).• Check the antenna setup. Contact a Sony dealer for advice.
TV cannot receive FM radio station.	<ul style="list-style-type: none">• Connect a separate FM antenna and the TV channel source through an antenna selector (switch) to your TV (see page 23).
The Ⓚ (standby) indicator on your TV flashes red several times after every three seconds.	<ul style="list-style-type: none">• Count the number of times the Ⓚ (standby) indicator flashes. Press Ⓚ (main power) to turn off your TV. Contact your nearest Sony service center.
The TV screen sometimes goes blank for slightly longer than usual during channel change.	<ul style="list-style-type: none">• The “Signal Booster” is functioning to detect a weak signal. This does not indicate a malfunction.
TV cabinet creaks.	<ul style="list-style-type: none">• Changes in room temperature sometimes make the TV cabinet expand or contract, causing a noise. This does not indicate a malfunction.
A small “boom” sound is heard when the TV is turned on.	<ul style="list-style-type: none">• The TV’s demagnetizing function is working. This does not indicate a malfunction

■ Specifications

	KV-SR292M63K	Note
Power requirements	220-240 V AC, 50/60 Hz	
Power consumption (W)	Indicated on the rear of the TV	
Television system	B/G, I, D/K, M	
Color system	PAL, PAL 60, SECAM, NTSC3.58, NTSC4.43	
Stereo/Bilingual system	NICAM Stereo/Bilingual B/G, I, D/K; A2 Stereo/Bilingual B/G	
Channel coverage		
B/G	VHF : E2 to E12 / UHF : E21 to E69 / CATV : S01 to S03, S1 to S41	
I	UHF : B21 to B68 / CATV : S01 to S03, S1 to S41	
D/K	VHF : C1 to C12, R1 to R12 / UHF : C13 to C57, R21 to R60 / CATV : S01 to S03, S1 to S41, Z1 to Z39	
M	VHF : A2 to A13 / UHF : A14 to A79 / CATV : A-8 to A-2, A to W+4, W+6 to W+84	
⌚ (Antenna)	75-ohm external terminal	
Audio output (Speaker)	7 W + 7 W	
3D Woofer	12 W	
Number of terminal		
📺 (Video)	Input: 4 Output: 1 Phono jacks; 1 Vp-p, 75 ohms	
🎧 (Audio)	Input: 5 Output: 1 Phono jacks; 500 mVrms	
📺 (S Video)	Input: 1 Y: 1 Vp-p, 75 ohms, unbalanced, sync negative C: 0.286 Vp-p, 75 ohms	
📺 (Component Video)	Input: 1 Phono jacks; Y: 1 Vp-p, 75 ohms, sync negative Cb: 0.7 Vp-p, 75 ohms Cr: 0.7 Vp-p, 75 ohms	
🎤 (MIC (Microphone))	Input: 2 Large jack	
🎧 (Headphone)	Output: 1 Stereo minijack	
FM Radio		
Tuning Range	87.5 - 108.0 MHz	
Intermediate Frequency	10.7 MHz	
Picture tube	29 in.	
Tube size (mm)	724	Measured diagonally
Viewing screen size (mm)	679	Measured diagonally
Dimensions (w/h/d, mm)	780 × 651 × 523	
Mass (kg)	51	

Design and specifications are subject to change without notice.