

FM Stereo FM-AM Receiver

STR-DB798

Easy Setup Guide

This Easy Setup Guide explains how to connect the DVD player, TV, speakers, and sub woofer so you can enjoy multi channel surround sound from the DVD player. For details, refer to the operating instructions supplied with the receiver.

Setting when using DVD player or "Play Station 2"

When you connect DVD player or "Play Station 2", perform the following settings on each component.

DVD player*

- 1 Select "AUDIO SETUP" in the setup display.
- 2 Set "AUDIO DRC" to "WIDE RANGE".
- 3 Set "DIGITAL OUT" to "ON".
- 4 Set "DOLBY DIGITAL" to "DOLBY DIGITAL".
- 5 Set "DTS" to "ON".

* The above setting is an example of Sony DVD player.

"Play Station 2"

- 1 Select "AUDIO SETTING" in the setup display.
- 2 Select "AUDIO DIGITAL OUTPUT".
- 3 Set "OPTICAL DIGITAL OUTPUT" to "ON".
- 4 Set "DOLBY DIGITAL" to "DOLBY DIGITAL".
- 5 Set "DTS" to "ON".

"Play Station 2" is a trademark of Sony Computer Entertainment.

Note

When connecting a DVD player, be sure to connect to analog (AUDIO L/R) jacks, not only digital (COAXIAL or OPTICAL) jacks.

If no sound comes out

Press INPUT MODE repeatedly to select "AUTO IN".

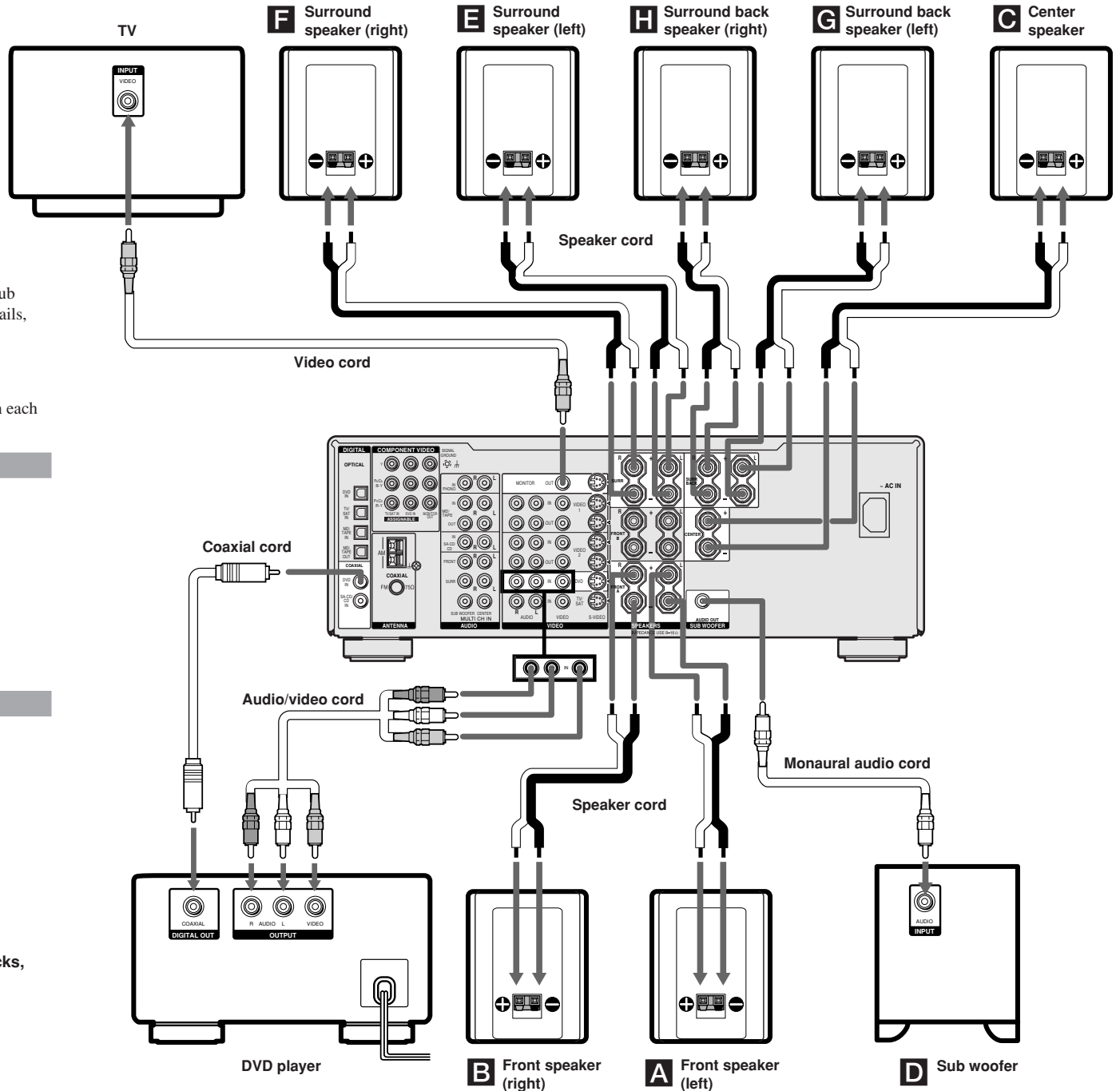

Easy setup guide for speaker system

Refer to the front page for speaker connections (A-H).

You can setup the speakers easily by selecting the speaker pattern.

- 1 Find your speaker pattern referring to the illustration below. You can use the flow chart on the right.
- 2 Press I/⏻ to turn on the system.
- 3 Press MAIN MENU repeatedly to select "SP SETUP".
- 4 Turn MENU to select "EASY SET". If it does not appear, select "NORM. SET" and turn -/+ to select "EASY SET".
- 5 Turn MENU to select "SP PAT. X-X".
- 6 Turn -/+ to select your speaker pattern, then press MEMORY/ENTER.

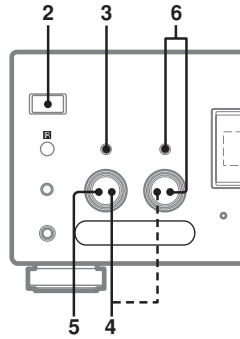

What is your speaker pattern ?

The speaker pattern depends on the number of speakers you have.

- | | | | |
|----------------------------|-------------------------|-------------------------------|------------------------------------|
| A Front speaker (L) | C Center speaker | E Surround speaker (L) | G Surround back speaker (L) |
| B Front speaker (R) | D Sub woofer | F Surround speaker (R) | H Surround back speaker (R) |

7 speakers and a sub woofer

Set to

7-1

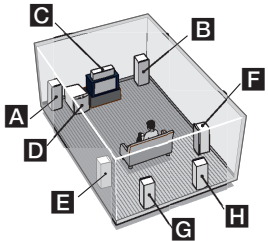

4 speakers

Set to

4-0

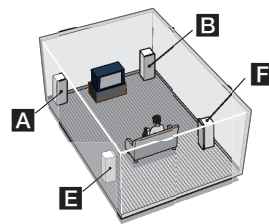

6 speakers and a sub woofer

Set to

6-1

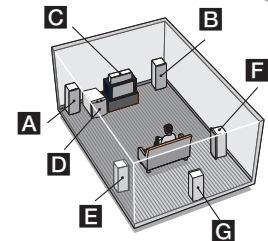

3 speakers

Set to

3-0

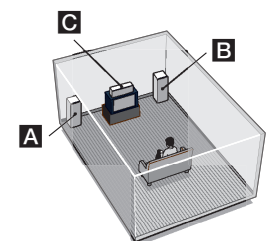

5 speakers and a sub woofer

Set to

5-1

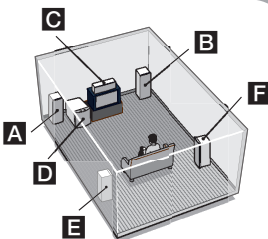

2 speakers

Set to

2-0

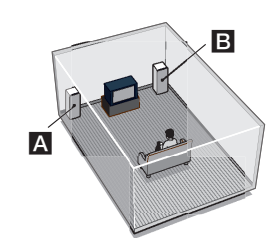

Refer to the illustration at left, follow → (Yes) if you have the speakers and follow (No) if you do not.

