



Micro HI-FI Component System

Operating Instructions



XR-EM333

WARNING

To prevent fire or shock hazard, do not expose the unit to rain or moisture.

To prevent fire, do not cover the ventilation of the apparatus with news papers, table-cloths, curtains, etc. And don't place lighted candles on the apparatus.

To prevent fire or shock hazard, do not place objects filled with liquids, such as vases, on the apparatus.

Do not install the appliance in a confined space, such as a bookcase or built-in cabinet.

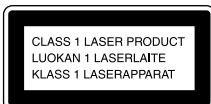

This appliance is classified as a CLASS 1 LASER product. This marking is located on the rear exterior.



Don't throw away the battery with general house waste, dispose of it correctly as chemical waste.

Except for European model



ENERGY STAR[®] is a U.S. registered mark. As an ENERGY STAR[®] partner, Sony Corporation has determined that this product meets the ENERGY STAR[®] guidelines for energy efficiency.

MPEG Layer-3 audio coding technology and patents licensed from Fraunhofer IIS and Thomson.

Table of Contents

How to use this manual.....	4
Playable discs.....	4

Getting Started

Hooking up the system.....	6
Setting the clock.....	7

CD/MP3 – Play

Loading a disc.....	8
Playing a disc.....	8
— Normal Play/Shuffle Play	
Playing repeatedly.....	9
— Repeat Play	
Creating your own program.....	10
— Program Play	

Tuner

Presetting radio stations.....	11
Listening to the radio.....	12
— Preset Tuning	
— Manual Tuning	

Tape – Play

Loading a tape.....	14
Playing a tape.....	14

Tape – Recording

Recording your favorite CD tracks on a tape.....	14
— CD-TAPE Synchro Recording	
Recording on a tape manually.....	15
— Manual Recording	

Sound Adjustment

Adjusting the sound.....	16
--------------------------	----

Timer

Falling asleep to music.....	16
— Sleep Timer	
Waking up to music.....	17
— Play Timer	
Timer recording radio programs.....	18
— Rec Timer	

Display

Turning off the display.....	19
— Power Saving Mode	
Viewing information about the disc in the display.....	19

Optional Components

Hooking up optional components.....	20
-------------------------------------	----

Troubleshooting

Problems and remedies.....	21
Messages.....	23

Additional Information

Precautions.....	25
Specifications.....	26
List of button locations and reference pages.....	28





How to use this manual

This manual mainly explains operations using the remote, but the same operations can also be performed using the buttons on the system having the same or similar names.

Playable discs

You can play back the following discs on this system. Other discs cannot be played back.

List of playable discs

Format of discs	Disc logo
Audio CDs	
CD-R/CD-RW (audio data/MP3 files)	   

Discs that this system cannot play

- CD-ROMs
- CD-Rs/CD-RWs other than those recorded in the following formats:
 - music CD format
 - MP3 format that conforms to ISO9660¹⁾ Level 1/Level 2, Joliet or Multi Session²⁾
- A disc that has a non-standard shape (e.g., card, heart).
- A disc with paper or stickers on it.
- A disc that has the adhesive, cellophane tape, or a sticker still left on it.

1) ISO9660 Format

The most common international standard for the logical format of files and folders on a CD-ROM. There are several specification levels. In Level 1, file names must be in the 8.3 format (no more than 8 characters in the name, no more than 3 characters in the extension “.MP3”) and in capital letters. Folder names can be no longer than 8 characters. There can be no more than 8 nested folder levels. Level 2 specifications allow file names and folder names up to 31 characters long. Each folder can have up to 8 trees.

For Joliet in the expansion format (file and folder names can have up to 16 characters) make sure of the contents of the writing software, etc.

2) Multi Session

This is a recording method that enables you to add data using the Track-At-Once method. Conventional CDs begin at a CD control area called the Lead-in and end at an area called Lead-out. A Multi Session CD is a CD having multiple sessions, with each segment from Lead-in to Lead-out regarded as a single session. This unit supports up to 10 sessions.

CD-Extra: This format records audio (audio CD data) on the tracks in session 1 and data on the tracks in session 2. This unit supports up to 10 sessions.

Mixed CD: This format records data on the first track and audio (audio CD data) on the second and subsequent tracks of a session.

Notes on CD-R and CD-RW

- Some CD-Rs or CD-RWs cannot be played on this system depending upon the recording quality or physical condition of the disc, or the characteristics of the recording device. Furthermore, the disc will not play if it has not been correctly finalized. For more information, see the operating instructions for the recording device.
- Discs recorded on CD-R/CD-RW drives may not be played back because of scratches, dirt, recording condition or the driver's characteristics.
- CD-R and CD-RW discs recorded in multi-session that have not ended by "closing the session" are not supported.
- The system may be unable to play MP3 format files that do not have the extension ".MP3".
- Attempting to play non-MP3 format files that have the extension ".MP3" may result in noise or malfunction.
- With formats other than ISO9660 Level 1 and 2, folder names or file names may not be displayed correctly.
- The following discs take a longer time to start playback.
 - a disc recorded with complicated tree structure.
 - a disc recorded in Multi Session.
 - a disc to which data can be added (non-finalized disc).

Music discs encoded with copyright protection technologies

This product is designed to playback discs that conform to the Compact Disc (CD) standard. Recently, various music discs encoded with copyright protection technologies are marketed by some record companies. Please be aware that among those discs, there are some that do not conform to the CD standard and may not be playable by this product.

Note on DualDiscs

A DualDisc is a two sided disc product which mates DVD recorded material on one side with digital audio material on the other side. However, since the audio material side does not conform to the Compact Disc (CD) standard, playback on this product is not guaranteed.

Cautions when playing a disc that is recorded in Multi Session

- If the disc begins with a CD-DA session, it is recognized as a CD-DA (audio) disc, and MP3 sessions are played back without sound.
- If the disc begins with an MP3 session, it is recognized as an MP3 disc, and CD-DA sessions are played back without sound.
- The playback range of an MP3 disc is determined by the tree structure of files produced by analyzing of the disc.
- A disc with a mixed CD format will be recognized as a CD-DA (audio) disc.

Getting Started

Hooking up the system

Perform the following procedures **1** to **4** to hook up your system using the supplied cords and accessories.

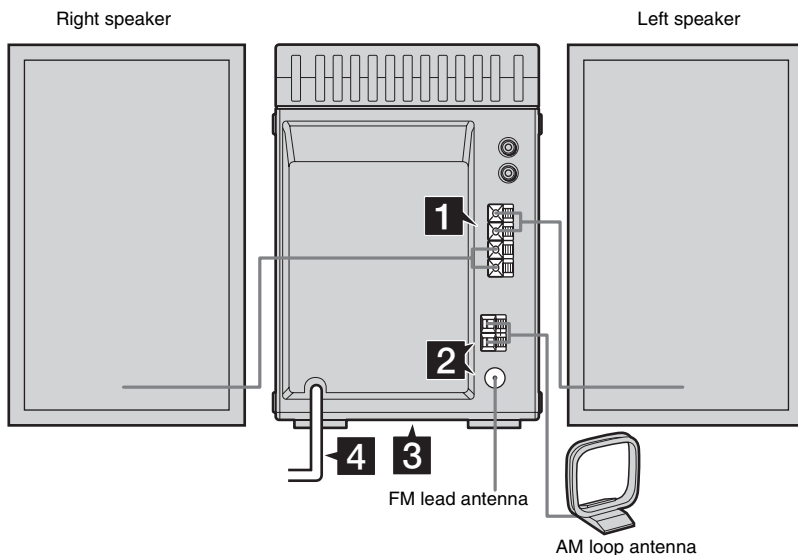

1 Connect the speakers.

Connect the right and left speaker cords to the SPEAKER terminals as shown below.

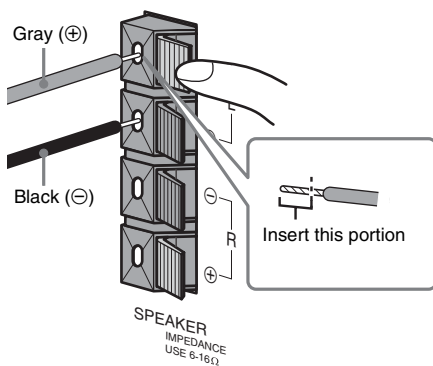

2 Connect the FM and AM antennas.

Set up the AM loop antenna, then connect it.

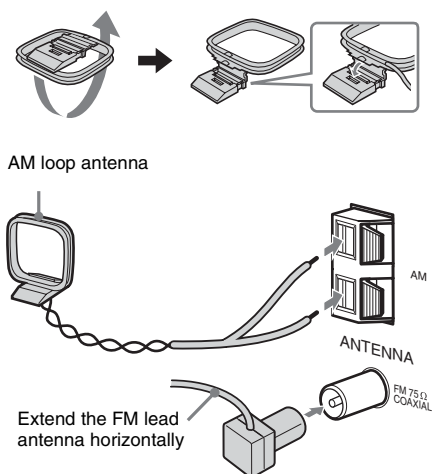

Note

To prevent noise pickup, keep the antennas away from the system and other components.

- 3 For models with a voltage selector, set VOLTAGE SELECTOR to the local power line voltage. The voltage selector is located at the bottom of the apparatus.**

Refer to the print on your system's VOLTAGE SELECTOR for available settings.

VOLTAGE SELECTOR



- 4 Connect the power cord to a wall outlet.**

If the plug does not fit the wall socket, detach the supplied plug adaptor (only for models equipped with an adaptor).

To turn on the system, press I/⏻.

Inserting two R6 (size AA) batteries into the remote

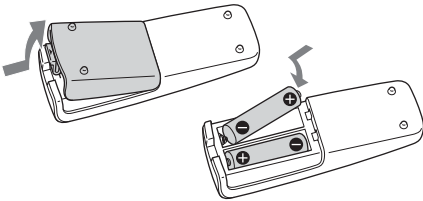
**Note**

If you do not use the remote for a long period of time, remove the batteries to avoid possible damage from battery leakage and corrosion.

Tip

When the remote no longer operates the system, replace both batteries with new ones.

Setting the clock

Use buttons on the remote for the operation.

- 1** Press I/⏻ to turn on the system.
- 2** Press CLOCK/TIMER SET.
- 3** Press ◀◀/▶▶ repeatedly to set the hour.
- 4** Press ENTER.
- 5** Press ◀◀/▶▶ repeatedly to set the minute.
- 6** Press ENTER.

The clock starts working.

To adjust the clock

- 1** Press CLOCK/TIMER SET.
- 2** Press ◀◀/▶▶ until "CLOCK" appears, then press ENTER.
- 3** Do the same procedures as step 3 to 6 above.

Note

The clock is not displayed in Power Saving Mode (page 19).

CD/MP3 – Play

Loading a disc

- 1 Press **OPEN** on the unit.
- 2 Place a disc with the label side up on the CD compartment.

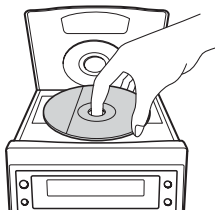

- 3 Press **OPEN** on the unit again to close the lid of the CD compartment.

Notes

- Do not use a disc with tape, seals or paste on it as this may cause malfunction.
- Keep the lens on the CD player clean and do not touch it. If you do so, the lens may be damaged and the CD player will not operate properly.

Playing a disc

— Normal Play/Shuffle Play

You can play audio CDs and discs with MP3 audio tracks.

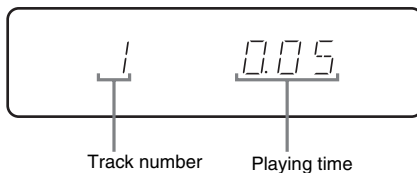

- 1 Press **CD** to switch the function to **CD**.
- 2 Press **PLAY MODE** in stop mode repeatedly until the mode you want appears.

Select	To play
No display (Normal Play)	The tracks on the disc in original order.
ALBM (Normal Play)	All MP3 audio tracks in the album on the disc in original order. When playing a non-MP3 disc, Album Play performs the same operation as Normal Play.
SHUF (Shuffle Play)	All tracks on the disc in random order.
ALBM SHUF (Shuffle Play)	All MP3 audio tracks in the album on the disc in random order. When playing a non-MP3 disc, Album Shuffle Play performs the same operation as Shuffle Play.
PGM (Program Play)	The tracks on the disc in the order you want them to be played (see “Creating your own program” on page 10).

- 3 Press **▶** (or **CD/▶||** on the unit).

Other operations

To	Do this
Stop play	Press ■.
Pause	Press ■■ (or CD/▶■■ on the unit). Press again to resume play.
Select a track	Press ◀◀/▶▶ repeatedly.
Select an album of MP3	Press ALBUM +/- repeatedly after step 2.
Find a point in a track	Keep pressing ◀◀/▶▶ during playback and release it at the desired point.
Remove a disc	Press OPEN on the unit.

Notes

- You cannot change the play mode during playback.
- Some time may be needed to start playback of discs recorded in complex configurations such as many layers.
- When the disc is inserted, the player reads all the audio tracks on that disc. If there are many albums or non-MP3 audio tracks on the disc, it may take a long time for play to begin or for the next MP3 audio track to start play.
- Do not save unnecessary albums or audio tracks other than MP3 ones in the disc to be used for MP3 listening. We recommend that you do not save other types of audio tracks or unnecessary albums on a disc that has MP3 audio tracks.
- An album that does not include an MP3 audio track is skipped.
- Maximum album number: 150 (including root album)
- The maximum number of MP3 audio tracks that can be contained on a single disc is 255.
- Playback is possible up to 8 levels.
- MP3 audio tracks are played back in the order that they are recorded on the disc.
- Depending on the encoding/writing software, recording device, or the recording media used at the time an MP3 audio track is recorded, you may encounter such problems as disabled playback, sound interruptions and noise.
- When playing back an MP3 audio track, the playback elapsed time indication may differ from the actual time in the following cases.
 - When you play back a VBR (variable bit rate) MP3 audio track
 - When you perform Fast Forward or Rewind (Manual Search)

Playing repeatedly

— Repeat Play

You can play all the tracks or a single track on a disc repeatedly.

Press REPEAT on the remote repeatedly during playback until “REP” or “REP 1” appears.

REP: For all the tracks on the disc up to five times.

REP 1: For a single track only.

To cancel Repeat Play

Press REPEAT repeatedly until both “REP” and “REP 1” disappear.

Note

When you select “REP 1”, that track is repeated endlessly until “REP 1” is canceled.

Creating your own program

— Program Play

You can make a program of up to 25 steps. You can synchro record the programmed tracks onto a cassette tape (page 14).

- 1 Press CD to switch the function to CD.**
- 2 Press PLAY MODE in stop mode repeatedly until “PGM” appears.**
- 3 Press ◀◀/▶▶ repeatedly until the desired track number appears.**

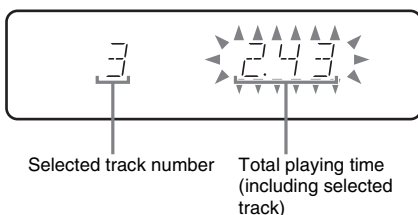

When programming an MP3, press ALBUM +/- repeatedly to select the album, then press ◀◀/▶▶ repeatedly until the desired track number appears.

- 4 Press ENTER on the remote.**
The track is programmed.
The program step number appears, followed by the last programmed track number and total playing time.
- 5 To program additional tracks, repeat steps 3 and 4.**
- 6 Press ▶.**
Program Play starts.

Other operations

To	Do this
Cancel Program Play	Press PLAY MODE in stop mode repeatedly until both “PGM” and “SHUF” disappears.
Erase the program	Press CLEAR in stop mode. Each time you press the button, a track is cleared from the end of the program.
Add a track to the end of the program	Perform steps 3 and 4 in stop mode.

Tips

- The program you made remains after Program Play finishes. To play the same program again, press ▶ (or CD/▶▶ on the unit). However, the program is cleared when you open the CD compartment.
- “- - -” appears if the total program time exceeds 100 minutes, if you select a track whose number is 21 or over, or when you programmed an MP3 audio track.

Presetting radio stations

You can preset up to 20 FM stations and 10 AM stations. You can then tune in any of those stations simply by selecting the corresponding preset number.

Automatic tuning preset

You can automatically tune in all of the stations that can be received in your area and then store the radio frequency of the desired stations.

- 1** Press **TUNER/BAND** repeatedly to select “FM” or “AM”.
- 2** Press **TUNING MODE** repeatedly until “AUTO” appears in the display.
- 3** Press **+/-** (or **TUNING +/-** on the unit).
The frequency changes as the system scans for a station. Scanning stops automatically when a station is tuned in. At that time, “TUNED” and “STEREO” (for stereo program only) appear.

If “TUNED” does not appear and the scanning does not stop

Set the frequency of the desired radio station as described in steps 2 and 3 of “Manual tuning preset” (page 11).

- 4** Press **TUNER MEMORY**.
A preset number flashes. Perform steps 5 and 6 while the preset number flashes.

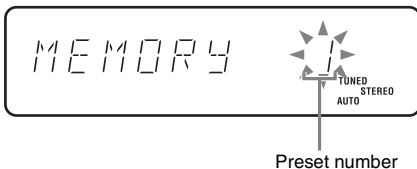

- 5** Press **+/-** (or **TUNING +/-** on the unit) repeatedly to select the desired preset number.
- 6** Press **ENTER**.

- 7** Repeat steps 3 through 6 to preset other stations.

Tip

Press **■** to stop scanning.

Manual tuning preset

You can manually tune in and store the radio frequency of the desired stations.

- 1** Press **TUNER/BAND** repeatedly to select “FM” or “AM”.
- 2** Press **TUNING MODE** on the unit repeatedly until “AUTO” and “PRESET” disappear from the display.
- 3** Press **+/-** (or **TUNING +/-** on the unit) repeatedly to tune in the desired station.
- 4** Press **TUNER MEMORY**.
- 5** Press **+/-** (or **TUNING +/-** on the unit) repeatedly to select the desired preset number.
- 6** Press **ENTER**.
- 7** Repeat steps 3 through 6 to preset other stations.

Other Operations

To	Do this
Tune in a station with a weak signal	Follow the procedure described in “Manual tuning preset” (page 11).
Set another station to the existing preset number	After step 4, press +/- (or TUNING +/- on the unit) repeatedly to select the preset number you want to store the station.

To change the AM tuning interval (except for European model)

The AM tuning interval is factory-preset to 9 kHz (or 10 kHz for some areas). To change the AM tuning interval, tune in any AM station first, then turn off the power by pressing I/⏻. While holding TUNING +, press I/⏻. When you change the interval, all the AM preset stations are initialized. To reset the interval, repeat the same procedure.

Note

You cannot change the setting in Power Saving Mode.

Tips

- The preset stations are retained for about half a day even if you disconnect the power cord or if a power failure occurs.
- To improve the reception, adjust the supplied antennas or connect an external antenna.

Listening to the radio

You can listen to a radio station either by selecting a preset station, or by manually tuning in the station.

Listening to a preset station

— Preset Tuning

Preset radio stations in the tuner's memory first (see "Presetting radio stations" on page 11).

- 1** Press TUNER/BAND repeatedly to select "FM" or "AM".
- 2** Press TUNING MODE repeatedly until "PRESET" appears in the display.
- 3** Press +/- (or TUNING +/- on the unit) repeatedly to select the desired preset station.

Listening to non-preset radio station

— Manual Tuning

- 1** Press TUNER/BAND repeatedly to select "FM" or "AM".
- 2** Press TUNING MODE repeatedly until "AUTO" and "PRESET" disappear from the display.
- 3** Press +/- (or TUNING +/- on the unit) repeatedly to tune in the desired station.

Tips

- To improve broadcast reception, adjust the supplied antennas, or connect a commercially available external antenna.
- When an FM stereo program has static noise, press FM MODE until “MONO” appears. There will be no stereo effect, but the reception will improve.
- Press TUNING MODE repeatedly until “AUTO” appears in step 2 above, then press +/- (or TUNING +/- on the unit). The frequency indication changes and scanning stops when the system tunes in a station (Automatic Tuning).
- To record the radio programs, use manual recording (page 15).
- You can change the display into the clock display (for 8 seconds) by pressing DISPLAY.

Tape – Play

Loading a tape

- 1 Press **▲ PUSH** on the unit.
- 2 Load a recorded/recordable tape into the cassette holder.

With the side you want to play/record facing forward.

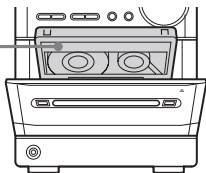

Playing a tape

You can use TYPE I (normal).

- 1 Press **TAPE** to switch the function to **TAPE**.
- 2 Press **▶ (TAPE/▶)** on the unit).

Other operations

To	Do this
Stop play	Press ■ .
Pause	Press ⏸ . Press again to resume play.
Fast-forward or rewind	Press ⏩/⏪ .
Remove a tape	Press ▲ PUSH on the unit in stop mode.

Tape – Recording

Recording your favorite CD tracks on a tape

— CD-TAPE Synchro Recording

You can record a whole CD on a tape. You can use TYPE I (normal). Use buttons on the unit for the operation.

- 1 Load a recordable tape.
- 2 Load a CD you want to record.

When you want to record an album from an MP3 disc, be sure to press **PLAY MODE** to select **ALBM**, then use **ALBUM +/-** to select the desired album before proceeding.

- 3 Press **CD SYNCHRO**.

“SYNC” and “REC” appear.

The tape deck stands by for recording and the CD player pauses for playback.

- 4 Press **● REC PAUSE/START**.

Recording starts.

When the recording is completed, the CD player and the tape deck stop automatically.

To stop recording

Press **■**.

To record a disc by specifying track order

You can record only your favorite CD tracks using Program Play. Between steps 2 and 3, perform steps 1 to 4 of “Creating your own program” (page 10).

Recording on a tape manually

— Manual Recording

You can record just the portions you like from a CD on a tape. You can also record a radio program.

Use buttons on the unit for the operation.

- 1 Load a recordable tape.**
- 2 Select the desired source to record.**
 - TUNER: To record from this system's tuner.
 - CD: To record from this system's CD player.
 - MD: To record from the optional component connected to the MD jacks.
- 3 Press ● REC PAUSE/START.**

“REC” appears and the tape deck stands by for recording.
- 4 Press ● REC PAUSE/START, then start playing the desired source to record.**

Recording starts.

Other operations

To	Do this
Stop recording	Press ■.
Pause recording	Press ● REC PAUSE/START.

Tip

For recording from a CD, you can press **⏮/⏭** to select tracks during recording pause mode (after step 3 and before step 4).

Sound Adjustment

Adjusting the sound

You can adjust the bass and treble to enjoy more powerful sound.

Generating a more dynamic sound

Press **i-Bass** on the unit.

To cancel the i-Bass, press i-Bass on the unit again.

Adjusting the bass and treble

You can adjust the bass and treble.

1 Press **EQ** (or **BASS/TREBLE** on the unit) repeatedly to select “**BASS**” or “**TREBLE**”.

Each time you press the button, the display changes cyclically as follows:

BASS ↔ **TREBLE**

2 Press **◀◀/▶▶** (or **TUNING +/-** on the unit) repeatedly to adjust the level while “**BASS**” or “**TREBLE**” appears.

Timer

Falling asleep to music

— Sleep Timer

You can set the system to turn off after a certain time, so that you can fall asleep to music.

Use buttons on the remote for the operation.

Press **SLEEP** repeatedly.

Each time you press the button, the minute display (the turn-off time) changes cyclically as follows:

AUTO* → **90MIN** → **80MIN** → ... → **10MIN** → **OFF**

* The system automatically turns off in 100 minutes or after the current CD or tape finishes playing.

Other operations

To	Press
Check the remaining time**	SLEEP once.
Change the time to turn off	SLEEP repeatedly to select the time you want.
Cancel Sleep Timer function	SLEEP repeatedly until “ OFF ” appears.

** You cannot check the remaining time if you select “**AUTO**”.

Note

Do not set to “**AUTO**” during Synchro Recording on a tape.

Tip

You can use Sleep Timer, even if you have not set the clock.

Waking up to music

— Play Timer

You can wake up to music at a preset time. Make sure you have set the clock (see “Setting the clock” on page 7).

Use buttons on the remote for the operation.

1 Prepare the sound source you want to play.

- CD: Load a disc. To start from a specific track, make a program (see “Creating your own program” on page 10).
- TAPE: Load a tape (see “Playing a tape” on page 14).
- TUNER: Tune in a radio station (see “Listening to the radio” on page 12).

2 Adjust the volume.

3 Press CLOCK/TIMER SET.

4 Press **◀◀/▶▶** repeatedly until “PLAY” appears, then press ENTER. “ON TIME” appears and the hour indication flashes.

5 Set the time to start playing.

Press **◀◀/▶▶** repeatedly to set the hour, then press ENTER.

The minute indication flashes.

Press **◀◀/▶▶** repeatedly to set the minute, then press ENTER.

6 Set the time to stop playing following the same procedure as step 5.

7 Press **◀◀/▶▶** repeatedly until the desired sound source appears.

Each time you press the button, the display changes cyclically as follows:

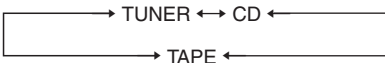

8 Press ENTER.

The start time, the stop time and the sound source, then the original display returns.

9 Press **I/⏻** to turn off the system.

Other operations

To	Do this
Cancel the timer/activate the timer/check the setting	1 Press CLOCK/TIMER SELECT and “SELECT” appears. 2 Press ◀◀/▶▶ repeatedly until “PLAY”, “REC” or “TIMER OFF” appears, then press ENTER.
Change the setting	Start over from step 1.

Notes

- If you use Play Timer and Sleep Timer at the same time, Sleep Timer has priority.
- Do not operate the system from the time the system turns on until the play starts (about 15 seconds before the preset time).
- If the system is on about 15 seconds before the preset time, Play Timer will not be activated.
- You cannot use the optional component connected to the MD jacks as sound sources for Play Timer.
- You cannot activate Play Timer and Rec Timer at the same time.
- The Play Timer setting remains as long as the setting is not canceled manually.

Timer recording radio programs

— Rec Timer

To timer record, you must first preset the radio station (see “Presetting radio stations” on page 11) and set the clock (see “Setting the clock” on page 7).

Use buttons on the remote for the operation.

- 1 Tune in the preset radio station (see “Listening to a preset station” on page 12).**
- 2 Press CLOCK/TIMER SET.**
- 3 Press ◀◀/▶▶ repeatedly until “REC” appears, then press ENTER.**
“ON TIME” appears and the hour indication flashes.
- 4 Set the time to start recording.**
Press ◀◀/▶▶ repeatedly to set the hour, then press ENTER.
The minute indication flashes.
Press ◀◀/▶▶ repeatedly to set the minute, then press ENTER.
- 5 Set the time to stop recording following the same procedure as step 4.**
Rec Timer settings and the desired station appear, then the original display returns.
- 6 Load a recordable tape.**
- 7 Press I/⏻ to turn off the system.**

Other operations

To	Do this
Cancel the timer/ activate the timer/ check the setting	<ol style="list-style-type: none">1 Press CLOCK/TIMER SELECT and “SELECT” appears.2 Press ◀◀/▶▶ repeatedly until “PLAY”, “REC” or “TIMER OFF” appears, then press ENTER.
Change the setting	Start over from step 1.

Notes

- If you use Rec Timer and Sleep Timer at the same time, Sleep Timer has priority.
- Do not operate the system from the time the system turns on until the recording starts (about 15 seconds before the preset time).
- If the system is on about 15 seconds before the preset time, Rec Timer will not be activated.
- The volume is reduced to minimum during recording.
- You cannot activate Play Timer and Rec Timer at the same time.
- The Rec Timer is canceled automatically after the Rec Timer has been activated.

Display

Turning off the display

— Power Saving Mode

The clock display can be turned off to minimize the amount of power consumed during standby (Power Saving Mode).

Press DISPLAY repeatedly while the system is off until the clock display disappears.

To cancel Power Saving Mode

Press DISPLAY while the system is off. Each time you press the button, the display switches as follows:

Clock display* ↔ No display (Power Saving Mode)

* The clock is displayed only if you set the clock.

Tips

- The I/⏻ indicator lights up even in Power Saving Mode.
- The timer continues to operate in Power Saving Mode.

Note

You cannot perform the following operations in Power Saving Mode.

- setting the clock
- changing the AM tuning interval

Viewing information about the disc in the display

You can check the playing time and remaining time of the current track or that of the disc.

When a disc with MP3 audio tracks is loaded, you can also check the information recorded on disc, such as the titles.

Checking the remaining time and titles (CD/MP3)

Press DISPLAY repeatedly during Normal Play.

Each time you press the button, the display changes cyclically as follows:

Current track number and elapsed playing time

→ Current track number and remaining time or

“- - - -”* → Remaining time of the disc or

“- - - -”* → Track title (disc with MP3 audio tracks** only) → Album name* → Clock display

* “- - - -” appears when you select a CD track whose number is 21 or over, or when you select an MP3 audio track.

** When you play back a track with an ID3 tag, the ID3 tag appears. The ID3 tag displays only the track title information.

Checking the total playing time and titles (CD/MP3)

Press DISPLAY repeatedly in stop mode.

Each time you press the button, the display changes cyclically as follows:

TOC display* or total number of albums on the disc** or total track number of the current album** → Album name** → Clock display

* TOC = Table of Contents; displays current disc number, total number of tracks on the disc and total playing time of the disc

** For discs with MP3 audio tracks, album titles may not be displayed depending on the play mode.

Optional Components

Hooking up optional components

To enhance your system, you can connect optional components. Refer to the operating instructions provided with each component.

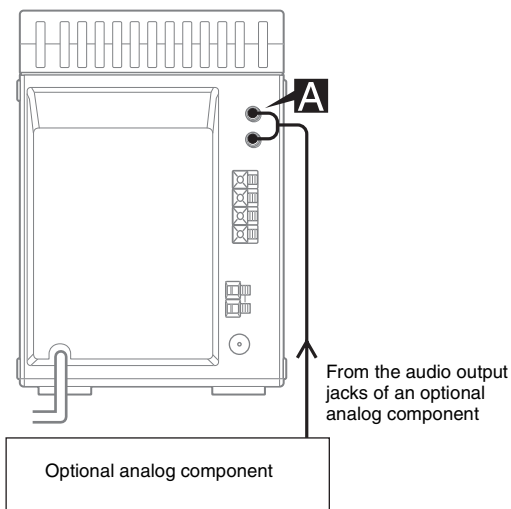

A MD jacks

Use audio cords (not supplied) to connect an optional analog component (MD deck, etc.) to these jacks. You can then listen to the sound from the component.

Listening to audio from a connected component

- 1 Connect audio cords.
See the illustration above.
- 2 Press FUNCTION repeatedly until "MD" appears.
Start playing the connected component.

Recording audio from a connected component

- 1 Connect audio cords.
- 2 Start recording manually.
See "Recording on a tape manually" on page 15.

Troubleshooting

Problems and remedies

Should you encounter a problem with your system, do the following:

- 1 Make sure the power cord and speaker cords are correctly and firmly connected.
- 2 Find your problem in the troubleshooting checklist below and take the indicated corrective action.

If the problem persists after doing all of the above, consult your nearest AIWA dealer.

When the I/⏻ indicator flashes

Immediately unplug the power cord and check the following items.

- If your system has a voltage selector, is the voltage selector set to the correct voltage? Check the voltage for your region, then make sure the voltage selector is set correctly.
- Are the + and – speaker cords short-circuited?
- Are you using the supplied speakers?
- Is anything blocking the ventilation holes on the rear of the system?

Check all the above items and fix any problems found. After I/⏻ indicator stops flashing, reconnect the power cord and turn on the system. If the indicator still flashes, or if the cause of the problem cannot be found even after checking all the above items, consult your nearest AIWA dealer.

General

“- -: -” appears in the display.

- A power interruption has occurred. Set the clock (page 7).

There is no sound.

- Press VOLUME + on the remote repeatedly (or turn VOLUME on the unit clockwise).
- Make sure the headphones are not connected.
- Check the speaker connections (page 6).

Sound comes from one channel, or unbalanced left and right volume.

- Place the speakers as symmetrically as possible.
- Connect the supplied speakers.

There is severe hum or noise.

- Move the system away from the source of noise.
- Connect the system to a different wall outlet.
- Install a noise filter (commercially available) to the power line.

The timer cannot be set.

- Set the clock again (page 7).

The timer does not function.

- Press CLOCK/TIMER SELECT on the remote to set the timer and light up “⏻ PLAY” or “⏻ REC” in the display (pages 17 and 18).
- Check the timer setting and set the correct time (pages 17 and 18).
- Cancel Sleep Timer function (page 16).
- Make sure the clock is correctly set.

The color on the TV screen is irregular.

- Move the speakers farther away from the TV set.

The remote does not function.

- Remove the obstacle.
- Move the remote closer to the system.
- Point the remote at the system’s sensor.
- Replace the batteries (R6/size AA).
- Locate the system away from the fluorescent light.

Speakers

Sound comes from one channel, or the left and right volumes are unbalanced.

- Check the speaker connections and placement.

CD/MP3 player

The sound drops out.

- The lens is dirty. Clean it with a commercially available blower.

Play does not start.

- Eject the disc and check whether a disc is loaded.
- Wipe the disc clean (page 25).
- Replace the disc.
- Load the disc that this system can play (page 4).
- Load the disc correctly.
- Load the disc with the label side up.
- Remove the disc and wipe away the moisture on the disc, then leave the system turned on for a few hours until the moisture evaporates.
- Press ► (or CD/►|| on the unit) to start play.

The sound skips.

- Wipe the disc clean (page 25).
- Replace the disc.
- Try moving the system to a place without vibration (e.g., on top of a stable stand).
- Try moving the speakers away from the system, or placing them on separate stands. When you listen to a track with bass sounds at high volume, the speaker vibration may cause the sound to skip.

Play does not start from the first track.

- Press PLAY MODE repeatedly until both “PGM” and “SHUF(FLE)” disappear to return to Normal Play.

MP3 audio track cannot be played back.

- Recording was not performed according to the ISO9660 Level 1 or Level 2 format, or Joliet in the expansion format.
- The MP3 audio track does not have the extension “.MP3”.
- The data is not stored in MP3 format.
- Discs containing tracks other than MPEG1, 2 Audio Layer-3 files cannot be played.

MP3 audio tracks take longer to play back than others.

- After the system reads all tracks on the discs, playback may take more time than usual if:
 - the number of albums or tracks on the disc is very large.
 - the album and track organization structure is very complex.

The album title, track title and ID3 tag do not appear correctly.

- Use a disc that conforms with ISO9660 Level 1, Level 2, or Joliet in the expansion format.

Tuner

Severe hum or noise/stations cannot be received.

- Set the proper band and frequency (page 11).
- Connect the antenna properly (page 6).
- Find a place and an orientation that provide good reception, then set up the antenna again. If you cannot obtain good reception, we recommend you connect a commercially available external antenna.
- The supplied FM lead antenna receives signals along its entire length, so make sure you extend it fully.
- Keep the antennas away from the system and other components.
- Consult your nearest AIWA dealer if the supplied AM antenna has come off the plastic stand.
- Try turning off surrounding electrical equipment.

A stereo FM program cannot be received in stereo.

- Press FM MODE until “STEREO” appears in the display.

Tape deck

The tape does not record or play, or there is a decrease in sound level.

- The heads are dirty. Clean them (page 26).
- The record/playback heads are magnetized. Demagnetize them (page 26).

The tape does not erase completely.

- The record/playback heads are magnetized. Demagnetize them (page 26).

There is excessive wow or flutter, or the sound drops out.

- The capstans in the tape deck are dirty. Clean them using a cleaning cassette (page 26).

Noise increases or the high frequencies are erased.

- The record/playback heads are magnetized. Demagnetize them (page 26).

The tape does not record.

- No cassette is loaded. Load a cassette.
- The tab has been removed from the cassette. Cover the broken tab with adhesive tape (page 26).
- The tape has wound to the end.

Optional components

There is no sound.

- Refer to General item “There is no sound.” (page 21) and check the condition of the system.
 - Connect the component properly (page 20) while checking:
 - if the cords are connected properly.
 - if the cord plugs are firmly inserted all the way.
 - Turn on the connected component.
 - Refer to the operating instructions supplied with the connected component and start playing.
 - Press FUNCTION repeatedly until “MD” appears (page 20).
-

The sound is distorted.

- Set the volume of the connected component lower.
-

If the system still does not operate properly after performing the above measures, reset the system as follows:

Use buttons on the unit for the operation.

- 1 Disconnect the power cord.
- 2 Reconnect the power cord.
- 3 Press I/⏻ to turn on the system.
- 4 Press ■, I/⏻ and turn volume to the left at the same time.

The system is reset to the factory settings. You should set the settings you made, such as the preset stations, clock, and timer.

Messages

One of the following messages may appear or flash in the display during operation.

CD/MP3

NO DISC

There is no disc in the player.

NO STEP

All of the programmed tracks have been erased.

OVER

You have reached the end of the disc while pressing and holding ►► during playback or pause.

STEP FULL

You tried to program 26 or more tracks (steps).

PUSH STOP

You pressed PLAY MODE during playback.

Tuner

COMPLETE

The preset operation ended normally.

Tape

NO TAB

You cannot record the tape because the tab has been removed from the cassette.

NO TAPE

There is no tape in the tape deck.

Timer

SET CLOCK

You tried to select the timer with the clock not set.

PUSH SELECT

You tried to set the clock or timer during timer operation.

SET TIMER

You tried to select the timer when Play Timer or Rec Timer are not set.

TIME NG

Play Timer or Rec Timer start and end times are set to the same time.

Other

INVALID

You pressed an invalid button.

Additional Information

Precautions

On operating voltage

- Before operating the system, check that the operating voltage of your system is identical with the voltage of your local power supply.
- The voltage selector is located at the bottom of the apparatus.

On safety

- The unit is not disconnected from the AC power source (mains) as long as it is connected to the wall outlet, even if the unit itself has been turned off.
- Unplug the system from the wall outlet (mains) if it is not to be used for an extended period of time. To disconnect the power cord (mains lead), pull it out by the plug. Never pull the cord itself.
- Should any solid object or liquid fall into the system, unplug the system and have it checked by qualified personnel before operating it any further.

On placement

- Do not place the system in an inclined position.
- Do not place the system in locations where it is:
 - Extremely hot or cold
 - Dusty or dirty
 - Very humid
 - Subject to vibrations
 - Subject to direct sunlight
- Use caution when placing the unit or speakers on surfaces that have been specially treated (with wax, oil, polish, etc.) as staining or discoloration of the surface may result.

On heat buildup

- Although the system heats up during operation, this is not a malfunction.
- Place the system in a location with adequate ventilation to prevent heat build-up in the system.
- If you continuously use this system at a high volume, the cabinet temperature of the top, side and bottom rises considerably. To avoid burning yourself, do not touch the cabinet.
- To prevent a malfunction, do not cover the ventilation hole.

On operation

- If the system is brought directly from a cold to a warm location, or is placed in a very damp room, moisture may condense on the lens inside the CD player. Should this occur, the system will not operate properly. Remove the disc and leave the system turned on for about an hour until the moisture evaporates.
- When you move the system, take out any disc.

If you have any questions or problems concerning your system, please consult your nearest AIWA dealer.

Notes on discs

- Before playing, clean the disc with a cleaning cloth. Wipe the disc from the center out.
- Do not use solvents such as benzene, thinner, commercially available cleaners or anti-static spray intended for vinyl LPs.
- Do not expose the disc to direct sunlight or heat sources such as hot air ducts, nor leave it in a car parked in direct sunlight.
- Do not use discs encircled with a protection ring. This may cause a malfunction to the system.
- When using discs that have glue or similar tacky substance on the label side of the disc or that used a special ink when the label was printed, there is a chance that the disc or label may become attached to parts inside this unit. When this occurs, it may not be possible to remove the disc, and may also cause this unit to malfunction. Be sure to check that the label side of the disc is not sticky before using.
The following types of disc should not be used:
 - Rental or used discs with attached seals where the glue extends beyond the seal. The perimeter of the seal on the disc is tacky.
 - Discs that have labels printed using a special ink that feels tacky when touched.
- Discs with non-standard shapes (e.g., heart, square, star) cannot be played on this unit. Attempting to do so may damage the unit. Do not use such discs.

Cleaning the cabinet

Clean the cabinet, panel and controls with a soft cloth slightly moistened with mild detergent solution. Do not use any type of abrasive pad, scouring powder or solvent such as thinner, benzene or alcohol.

To save a tape permanently

To prevent a tape from being accidentally recorded over, break off the cassette tab from side A or B as illustrated.

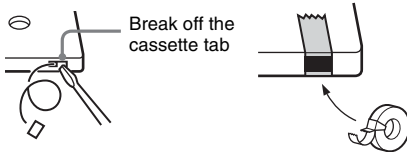

If you later want to reuse the tape for recording, cover the broken tab with adhesive tape.

Before placing a cassette in the tape deck

Take up any slack in the tape. Otherwise, the tape may get entangled in the parts of the tape deck and become damaged.

When using a tape longer than 90 minutes

The tape is very elastic. Do not change the tape operations such as play, stop, and fast-winding frequently. The tape may get entangled in the tape deck.

Cleaning the tape heads

Clean the tape heads after every 10 hours of use. Be sure to clean the tape heads before you start an important recording or after playing an old tape. Use a separately sold dry-type or wet-type cleaning cassette. For details, refer to the instructions of the cleaning cassette.

Demagnetizing the tape heads

Demagnetize the tape heads and the metal parts that have contact with the tape after every 20 to 30 hours of use with a separately sold demagnetizing cassette. For details, refer to the instructions of the demagnetizing cassette.

Specifications

Main unit

Amplifier section

European model:

DIN power output (rated): 11 + 11 W

(6 ohms at 1 kHz, DIN)

Continuous RMS power output (reference):

15 + 15 W

(6 ohms at 1 kHz, 10% THD)

Music power output (reference):

25 + 25 W

Other models:

The following measured at AC 230 V or AC 120 V, 50/60 Hz

DIN power output (rated): 11 + 11 W

(6 ohms at 1 kHz, DIN)

Continuous RMS power output (reference):

15 + 15 W

(6 ohms at 1 kHz, 10% THD)

Inputs

MD (phono jacks):

Sensitivity 450 mV,
impedance 47 kilohms

Outputs

PHONES:

Accepts headphones with
an impedance of 8 ohms or
more

SPEAKER:

Accepts impedance of 6 to
16 ohms.

CD player section

Laser Diode Properties

Emission duration:
continuous
Laser Output*:
Less than 44.6μW

* This output is the value measurement at a distance of 200mm from the objective lens surface on the Optical Pick-up Block with 7mm aperture.

Frequency response

20 Hz – 20 kHz

Tape deck section

Recording system

4-track 2-channel, stereo

Frequency response

50 – 13,000 Hz (±3 dB),
using Sony TYPE I
cassettes

Wow and flutter

±0.15% W. Peak (IEC)
0.1% W. RMS (NAB)
±0.2% W. Peak (DIN)

Tuner section

FM stereo, FM/AM superheterodyne tuner

FM tuner section

Tuning range 87.5 – 108.0 MHz
Antenna FM lead antenna
Antenna terminals 75 ohms unbalanced
Intermediate frequency 10.7 MHz

AM tuner section

Pan-American model: 530 – 1,710 kHz
(with the tuning interval set at 10 kHz)
531 – 1,710 kHz
(with the tuning interval set at 9 kHz)

European model: 531 – 1,602 kHz
(with the tuning interval set at 9 kHz)

Other models: 530 – 1,710 kHz
(with the tuning interval set at 10 kHz)
531 – 1,602 kHz
(with the tuning interval set at 9 kHz)

Antenna AM loop antenna, external antenna terminal

Intermediate frequency 450 kHz

Speaker

Speaker system Full Range, bass-reflex type

Speaker units

Woofer: 10 cm dia., cone type
Nominal impedance 6 ohms
Dimensions (w/h/d) Approx. 140 × 230.5 × 145 mm

Mass Approx. 1.4 kg net per speaker

General

Power requirements

European model: 230 V AC, 50/60 Hz
Korean model: 220 V AC, 60 Hz
Australian model: 230 – 240 V AC, 50/60 Hz
Taiwanese model: 120 V AC, 50/60 Hz
Mexican model: 120 V AC, 60 Hz
Argentine model: 220 V AC, 50/60 Hz
Other models: 110 – 120 V or 220 – 240 V AC, 50/60 Hz
Adjustable with voltage selector

Power consumption 50 W
0.3 W (in Power Saving Mode)

Dimensions (w/h/d) Approx. 164 × 230.5 × 266 mm incl. projecting parts and controls

Mass Approx. 3.5 kg

Supplied accessories Remote Commander (1)
R6 (size AA) batteries (2)
AM loop antenna (1)
FM lead antenna (1)

Design and specifications are subject to change without notice.



- Standby power consumption: 0.3 W
- Halogenated flame retardants are not used in the certain printed wiring boards.
- Lead-free solder is used for soldering certain parts.
- Halogenated flame retardants are not used in cabinets.

List of button locations and reference pages

How to use this page

Use this page to find the location of buttons and other parts of the system that are mentioned in the text.

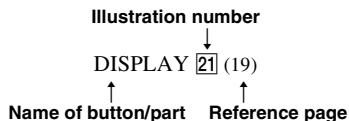

Main unit

ALPHABETICAL ORDER

A - O

- ALBUM +/- **15** (9, 10, 14)
- BASS/TREBLE **5** (16)
- Cassette compartment **11**
- CD SYNCHRO **13** (14)
- DISPLAY **20** (19)
- Display window **2**
- i-Bass **6** (16)
- OPEN (CD open/close) **4** (9)

P - Z

- PHONES jack **14**
- PLAY MODE **8** (8, 10, 14)
- Remote sensor **3**
- TUNER/BAND **17** (11, 12)
- TUNING +/- **16** (11, 12, 16)
- TUNING MODE **8** (11, 12)
- VOLUME **9** (17, 21, 23)

BUTTON DESCRIPTIONS

- I/⏻ (power) **1** (7, 17, 23)
- ⏮⏪⏩⏭ (skip back/skip forward, rewind/fast forward) **16** (9, 10, 14)
- (stop) **7** (9, 14, 15, 23)
- REC PAUSE/START **12** (14, 15)
- CD/▶⏸ (play/pause) **18** (9, 10, 22)
- TAPE/▶ (play) **19** (14)
- ▲ PUSH (tape open/close) **10** (14)

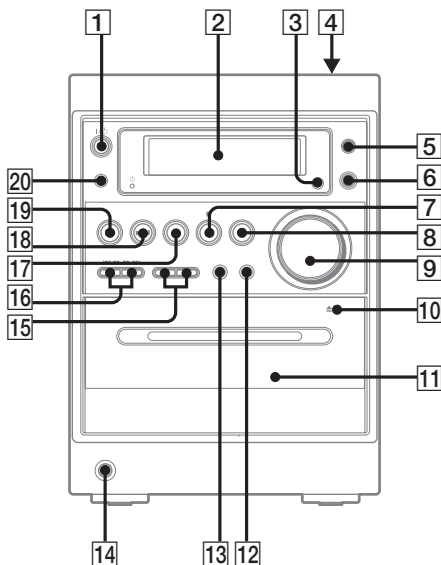

Remote control

ALPHABETICAL ORDER

A - O

- ALBUM +/- **11** (9, 10)
- CD **16** (8, 10)
- CLEAR **13** (10)
- CLOCK/TIMER SELECT **2**
(17, 18, 21)
- CLOCK/TIMER SET **3** (7, 17,
18)
- DISPLAY **19** (19)
- ENTER **9** (7, 10, 11, 17, 18)
- EQ **12** (16)
- FM MODE **4** (12, 22)
- FUNCTION **6** (20, 23)

P - Z

- PLAY MODE **18** (8, 10, 22)
- REPEAT **4** (9)
- SLEEP **20** (16)
- TAPE **15** (14)
- TUNER/BAND **5** (11, 12)
- TUNER MEMORY **17** (11)
- TUNING MODE **18** (11, 12)
- VOLUME +/- **10** (17, 21)

BUTTON DESCRIPTIONS

- I/⏻ (power) **1** (7, 17, 23)
- ◀▶ (rewind/fast forward)
7 (9, 14)
- ◀▶▶ (go back/go forward)
14 (7, 9, 10, 17, 18)
- (stop) **8** (9, 14, 15, 23)
- ⏸ (pause) **8** (9, 14)
- ▶ (play) **8** (8, 10, 18)
- +/- (tuning) **14** (11, 12)
- * Button does not function with
this model.

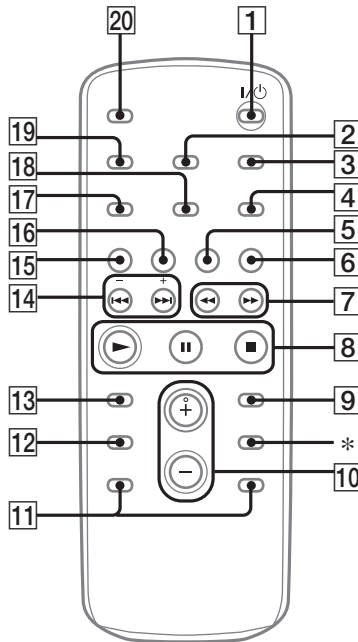



Printed on 100 % recycled
paper using VOC (Volatile
Organic Compound)-free
vegetable oil based ink.