

Thank you for purchasing this Sony product.

After following this step by step guide you will be able to:

Insert Batteries into the Remote Control.

Connect the Aerial and VCR to your TV.

Select the language of the menu screens.

Adjust the picture slant.

Tune your TV.

Change the order in which channels are stored.

View TV Programmes.

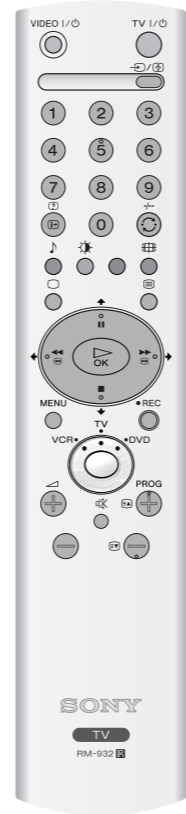

Remote Control
RM-932



2 Batteries (AA size)

Inserting Batteries into the Remote Control

- ⚠ Make sure you insert the supplied batteries using the correct polarities.
- Always remember to dispose of used batteries in an environmentally friendly way.

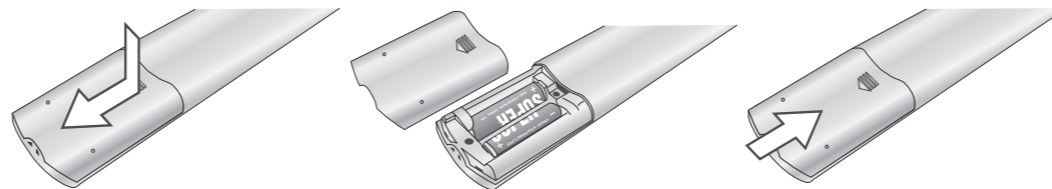

1

3

i Connecting cables are not supplied.

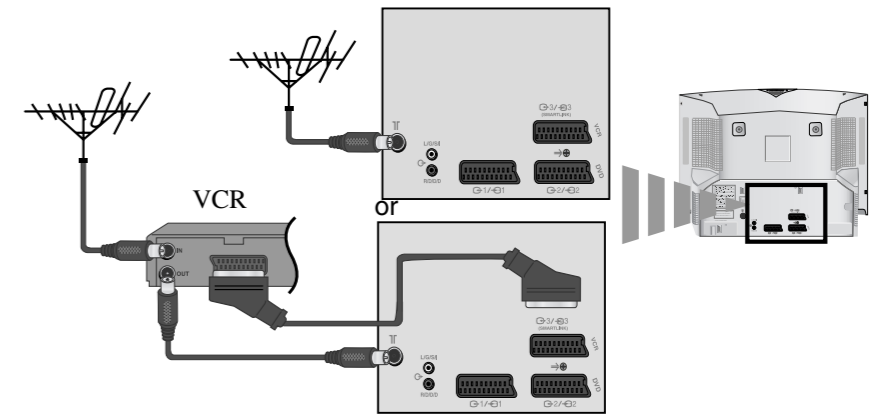

i The Scart lead is optional. If you use this optional connection it can improve the picture and sound quality when using a VCR.

A If you do not use a SCART lead, after automatically tuning the TV refer to the "Manual Programme Preset" option on page 13 step a) of the instruction manual, to tune in the VCR channel to your TV.

Switching on the TV

4

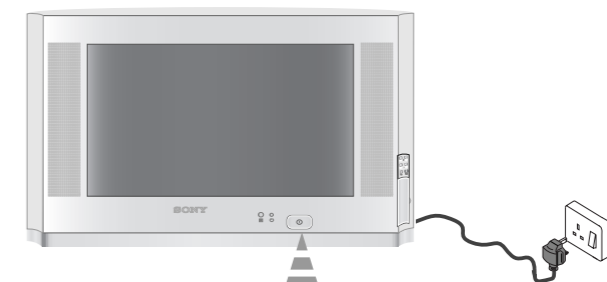

Connect the TV plug to the mains socket.

The first time the TV set is connected, it is usually turned on. If the TV is off, push in the **On/Off** switch on the front of the TV.

FD Trinitron **WIDE** Colour Television

Selecting the language of the menu screens

5

Automatically Tuning the TV

7

Changing the Programme Order of the broadcast channels

8

This TV set works with menu screens. By following the instructions below, you can select the desired language of the menu screens.

You need to tune the TV to receive channels. By following the instructions below, this TV automatically searches and stores all available broadcast channels for you.

By following the instructions below, you can rearrange the order in which broadcast channels appear on the screen.

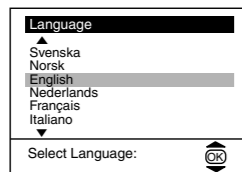
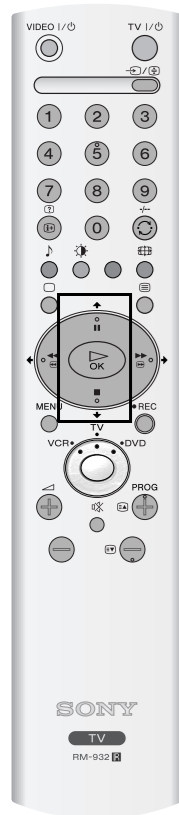

The first time that you switch on your TV, the Language menu appears automatically.

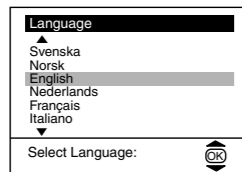

Press the **↓** or **↑** button on the remote control to select the language, then press the **OK** button on the remote control to confirm your selection.

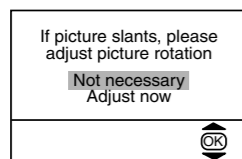

The Picture Rotation menu appears on the screen.

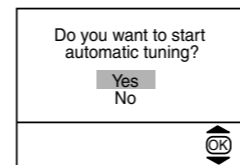
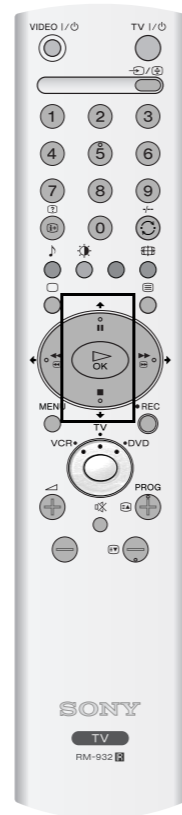

Press the **OK** button on the remote control to select **Yes**.

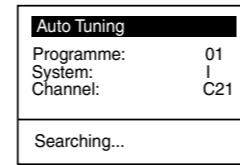

The TV starts to automatically search and store all available broadcast channels for you.

⚠ This procedure could take a number of minutes. Please be patient and do not press any buttons while the automatic tuning is in progress. Otherwise the automatic tuning will not be completed.

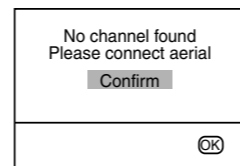

⚠ If no channels were found during the auto tuning process then a new menu appears automatically on the screen asking you to connect the aerial. Please connect the aerial (see step 3) and press **OK**. The auto tuning process will start again.

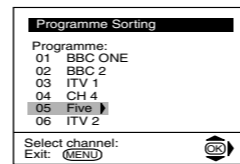

When the automatic tuning is finished, the Programme Sorting menu appears on the screen.



a) If you wish to keep the broadcast channels in the tuned order:

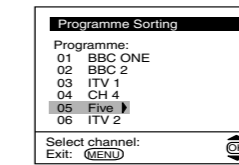

- Press the **MENU** button on the remote control to exit and return to the normal TV screen.

👍 Your TV is now ready for use.

b) If you wish to store the TV broadcast channels in a different order.

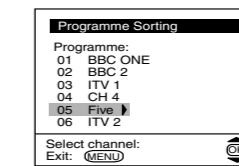

- Press the **↓** or **↑** button to select the programme number that has the channel (TV Broadcast) you wish to rearrange, then press the **↔** button.

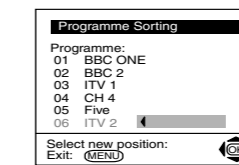

- Press the **↓** or **↑** button on the remote control to select the new programme number position for your selected channel, then press the **←** button.

- Repeat all the above steps if you wish to change the order of the other broadcast channels on your TV.

- Press the **MENU** button on the remote control to exit and return to the normal TV screen.

👍 Your TV is now ready for use.

Correcting the Picture Slant

6

Because of the earth's magnetism, the picture may slant. By following the instructions below, you can correct the picture slant if necessary.

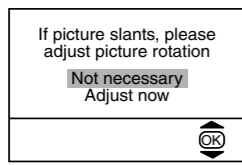

a) If it is not necessary, press the **↓** or **↑** button on the remote control to select **Not necessary** then press **OK**.

b) If it is necessary, press the **↓** or **↑** button to select **Adjust now**, then press **OK** and correct any slant of the picture between **-5** and **+5** by pressing the **↓** or **↑** button. Finally press **OK** to store.

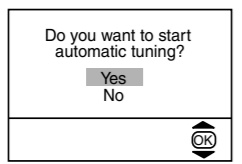

The automatic tuning menu appears on the TV screen.

Your television stations are now stored in your television's memory.