

# ***FM Stereo FM/AM Receiver***

---

Operating Instructions

***STR-DB795***

## WARNING

### To prevent fire or shock hazard, do not expose the unit to rain or moisture.

To prevent fire, do not cover the ventilation of the apparatus with news papers, table-cloths, curtains, etc. And don't place lighted candles on the apparatus.

To prevent fire or shock hazard, do not place objects filled with liquids, such as vases, on the apparatus.

Do not install the appliance in a confined space, such as a bookcase or built-in cabinet.



Don't throw away batteries with general house waste; dispose of them correctly as chemical waste.

### Except for European model



ENERGY STAR® is a U.S. registered mark. As an ENERGY STAR® partner, Sony Corporation has determined that this product meets the ENERGY STAR® guidelines for energy efficiency.

## About This Manual

- The instructions in this manual are for model STR-DB795. Check your model number by looking at the lower right corner of the front panel.
- The instructions in this manual describe the controls on the receiver. You can also use the controls on the supplied remote if they have the same or similar names as those on the receiver. For details on the use of your remote, see pages 45–52.

### About area codes

The area code of the receiver you purchased is shown on the lower portion of the rear panel (see the illustration below).

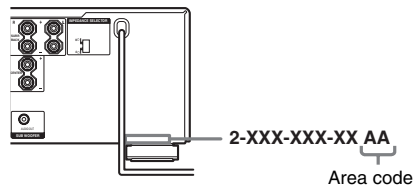

Any differences in operation, according to the area code, are clearly indicated in the text, for example, "Models of area code AA only".

This receiver incorporates Dolby\* Digital and Pro Logic Surround and the DTS\*\* Digital Surround System.

\* Manufactured under license from Dolby Laboratories.

"Dolby", "Pro Logic" and the double-D symbol are trademarks of Dolby Laboratories.

\*\*"DTS", "DTS-ES", "Neo:6" and "DTS 96/24" are trademarks of Digital Theater Systems, Inc.

## Note for the supplied remote

### RM-PP413

The SOURCE button on the remote is not available for receiver operation.

# Table of Contents

---

## Getting Started

- 1: Check how to hookup your components ..... 4
  - 1a: Connecting components with digital audio output jacks ..... 6
  - 1b: Connecting components with multi channel output jacks..... 9
  - 1c: Connecting components with only analog audio jacks ..... 11
- 2: Connecting the antennas ..... 13
- 3: Connecting speakers ..... 14
- 4: Connecting the AC power cord ..... 16
- 5: Setting up the speakers ..... 17
- 6: Adjusting the speaker levels and balance ..... 20
  - TEST TONE

---

## Amplifier Operation

- Selecting the component ..... 21
- Listening to multi channel sound ..... 21
  - MULTI CH IN
- Listening to FM/AM radio ..... 22
- Storing FM stations automatically ..... 23
  - AUTOBETICAL  
(Models of area code CEL, CEK only)
- Presetting radio stations ..... 23
- Using the Radio Data System (RDS).... 24  
(Models of area code CEL, CEK only)
- Changing the display ..... 26
- About the indications in the display ..... 27

---

## Enjoying Surround Sound

- Using only the front speakers ..... 29
- Enjoying higher fidelity sound..... 29
  - AUTO FORMAT DIRECT
- Selecting a sound field ..... 31
- Selecting the surround back decoding mode ..... 33
  - SURR BACK DECODING

---

## Advanced Adjustments and Settings

- Switching the audio input mode for digital components ..... 35
  - INPUT MODE
- Customizing sound fields ..... 35
- Adjusting the equalizer ..... 37
- Advanced settings ..... 37

---

## Other Operations

- Naming preset stations and inputs ..... 41
- Using the Sleep Timer ..... 42
- Selecting the speaker system ..... 42
- Recording ..... 43
- CONTROL A1II Control System ..... 44

---

## Operations Using the Remote RM-PP413

- Before you use your remote ..... 45
- Remote button description ..... 45
- Selecting the command mode of the remote ..... 49
- Programming the remote ..... 50

---

## Additional Information

- Precautions ..... 53
- Troubleshooting ..... 53
- Specifications ..... 56
- List of button locations and reference pages ..... 59
- Index ..... 60

# 1: Check how to hookup your components

Steps 1a through 1c beginning on page 6 describe how to hook up your components to this receiver. Before you begin, refer to “Connectable components” below for the pages which describe how to connect each component.

After hooking up all your components, proceed to “2: Connecting the antennas” (page 13).

## Connectable components

Component to be connected	Page
DVD player	
With digital audio output <sup>a)</sup>	6–7
With multi-channel audio output <sup>b)</sup>	9–10
With analog audio output only <sup>c)</sup>	6–7
TV monitor	
With component video input <sup>d)</sup>	7 or 10
With S-Video or composite video input only	12
Satellite tuner	
With digital audio output <sup>a)</sup>	6–7
With analog audio output only <sup>c)</sup>	6–7
CD/Super Audio CD player	
With multi-channel audio output <sup>b)</sup>	9
With analog audio output only <sup>c)</sup>	11
MD/Tape deck	
With digital audio output <sup>a)</sup>	8
With analog audio output only <sup>c)</sup>	11
Analog disc turntable	11
Multi-channel decoder	9
VCR, video camera, video game, etc.	12

<sup>a)</sup> Model with a DIGITAL OPTICAL OUTPUT or DIGITAL COAXIAL OUTPUT jack, etc.

<sup>b)</sup> Model with a MULTI CH OUTPUT jacks, etc. This connection is used to output the audio decoded by the component's internal multi-channel decoder through this receiver.

<sup>c)</sup> Model equipped only with AUDIO OUT L/R jacks, etc.

<sup>d)</sup> Model with component video (Y, Pb/Cb/B-Y, Pr/Cr/R-Y) input jacks.

## Required cords

The hookup diagrams on the subsequent pages assume the use of the following optional connection cords (**A** to **H**) (not supplied).

### **A** Audio cord

White (L)  
Red (R)



### **B** Audio/video cord

Yellow (video)  
White (L/audio)  
Red (R/audio)



### **C** Video cord

Yellow



### **D** S-video cord



### **E** Optical digital cord



### **F** Coaxial digital cord



### **G** Monaural audio cord

Black



### **Tip**

Audio cord **A** can be torn into two monaural audio cords **G**.

### **H** Component video cord

Green  
Blue  
Red



### Notes

- Turn off the power to all components before making any connections.
- Be sure to make connections firmly to avoid hum and noise.
- When connecting an audio/video cord, be sure to match the color-coded pins to the appropriate jacks on the components: yellow (video) to yellow; white (left, audio) to white; and red (right, audio) to red.
- When connecting optical digital cords, insert the cord plugs straight in until they click into place.
- Do not bend or tie optical digital cords.

## If you have Sony components with CONTROL A1II jacks

See “CONTROL A1II Control System” on page 44.

# 1a: Connecting components with digital audio output jacks

## Hooking up a DVD player, TV, or satellite tuner

For details on the required cords (**A**–**H**), see page 5.

### 1 Connect the audio jacks.

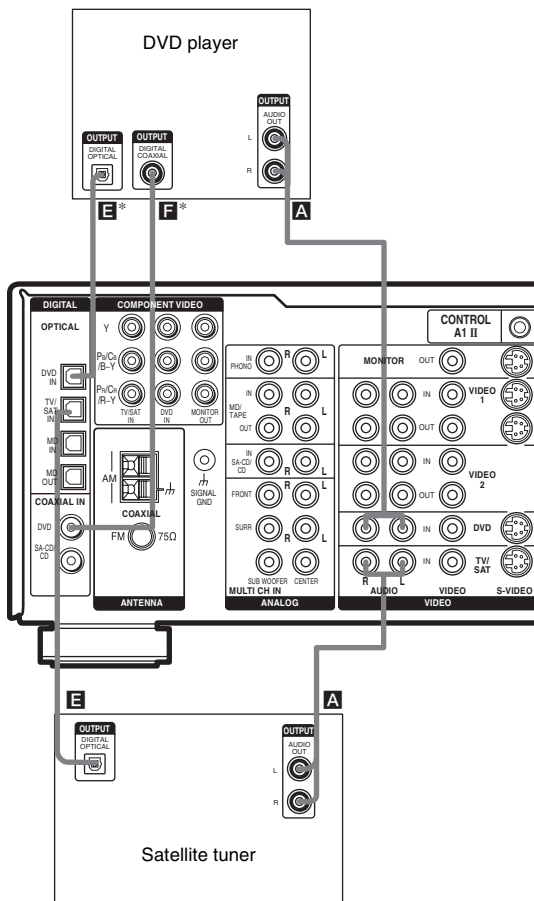

\* Connect to either the COAXIAL DVD IN or the OPTICAL DVD IN jack. We recommend making connections to the COAXIAL DVD IN jack.

#### Note

You can also listen to the sound of your TV by connecting your TV's audio output jacks to the TV/SAT AUDIO IN jacks on the receiver. In this case, do not connect the TV's video output jack to the TV/SAT VIDEO IN jack on the receiver.

## 2 Connect the video jacks.

The following illustration shows how to connect a TV or satellite tuner and a DVD player with COMPONENT VIDEO (Y, P<sub>B</sub>/C<sub>B</sub>/B-Y, P<sub>R</sub>/C<sub>R</sub>/R-Y) output jacks. Connecting a TV with component video input jacks allows you to enjoy higher quality video.

### Tip

This receiver can convert standard video signals to S-video signals for output from the MONITOR S-VIDEO OUT jacks.

### Note

On this receiver, the component video signals cannot be converted to S-video or standard video signals (or vice versa).

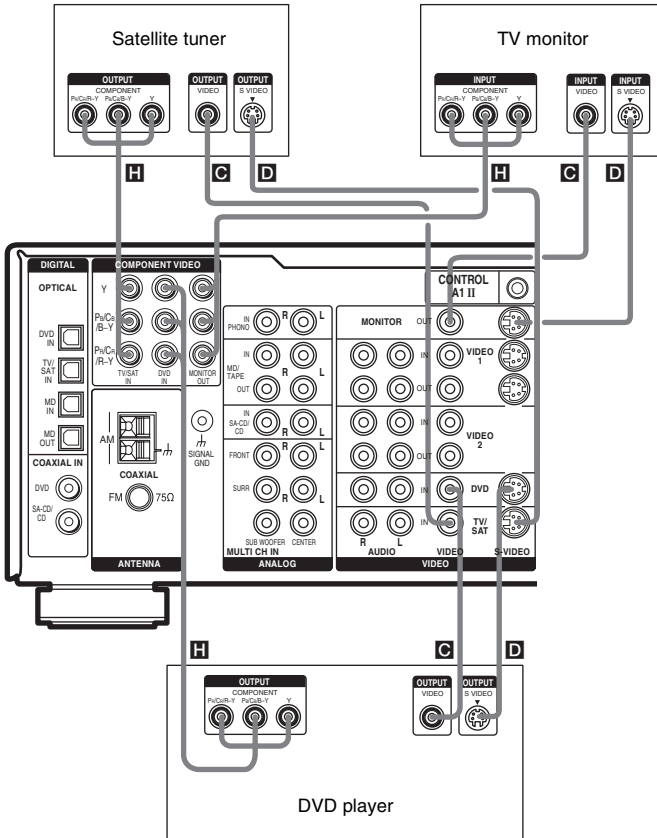

# Hooking up an MD/Tape deck or a Super Audio CD/CD player

For details on the required cords (A–H), see page 5.

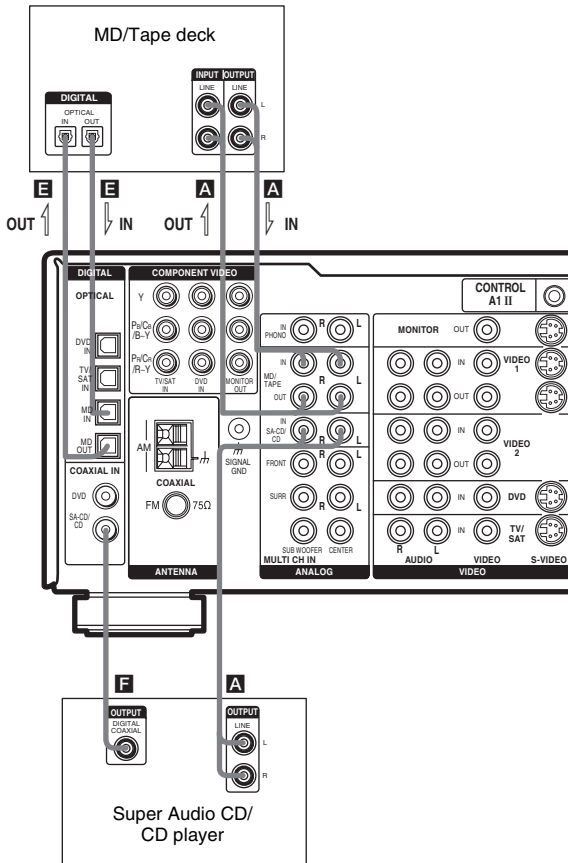

**Tip**

All the digital audio jacks are compatible with 32 kHz, 44.1 kHz, 48 kHz and 96 kHz sampling frequencies.

**Note**

You cannot make digital recordings of digital multi channel surround signals.



# 1b: Connecting components with multi channel output jacks

## 1 Connect the audio jacks.

If your DVD or Super Audio CD player is equipped with multi channel output jacks, you can connect it to this receiver's MULTI CH IN jacks to enjoy the multi channel sound. Alternatively, the multi channel input jacks can be used to connect an external multi channel decoder. For details on the required cords (**A-H**), see page 5.

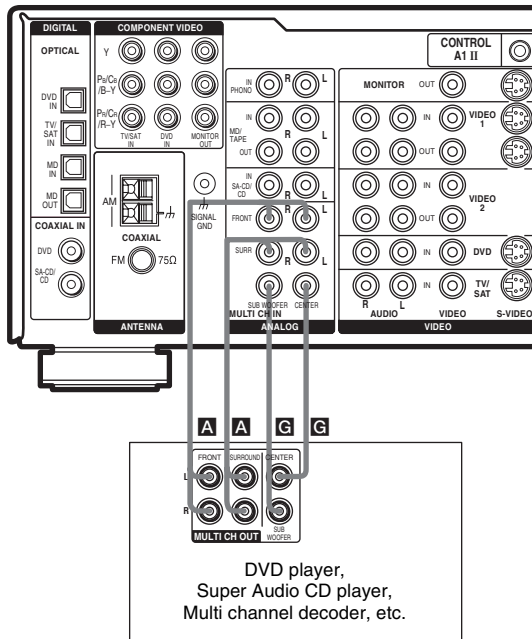

### Tip

This connection also allows you to enjoy software with multi-channel audio recorded in formats other than the Dolby Digital, and DTS.

## 2 Connect the video jacks.

The following illustration shows how to connect a DVD player with COMPONENT VIDEO (Y, Pb/Cb/B-Y, Pr/Cr/R-Y) output jacks. Connecting a TV with component video input jacks allows you to enjoy higher quality video.

### Tip

This receiver can convert standard video signals to S-video signals for output from the MONITOR S-VIDEO OUT jacks.

### Note

On this receiver, the component video signals cannot be converted to S-video or standard video signals (or vice versa).

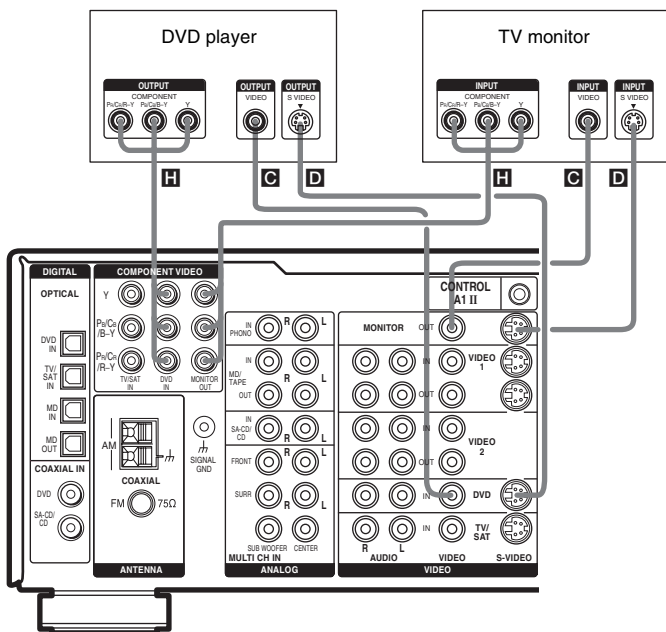

# 1c: Connecting components with only analog audio jacks

## Hooking up audio components

For details on the required cords (A-H), see page 5.

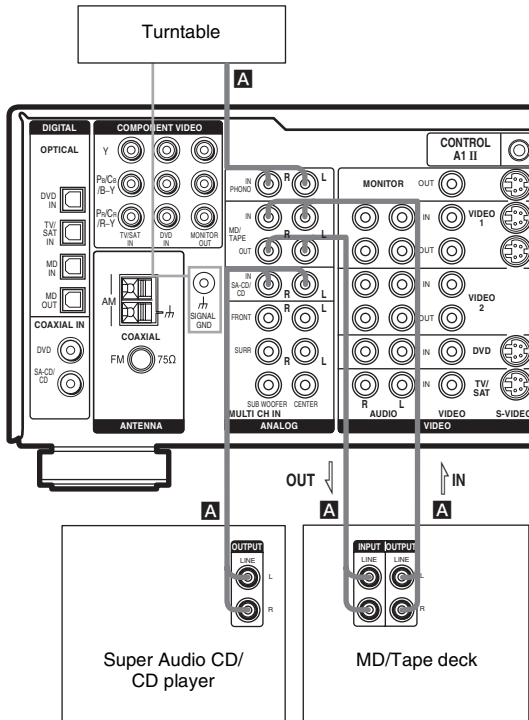

### Note

If your turntable has a ground wire, connect it to the  $\text{h}$  SIGNAL GND terminal.

## Hooking up video components

If you connect your TV to the MONITOR jacks, you can watch the video from the selected input (page 21). For details on the required cords (**A-H**), see page 5.

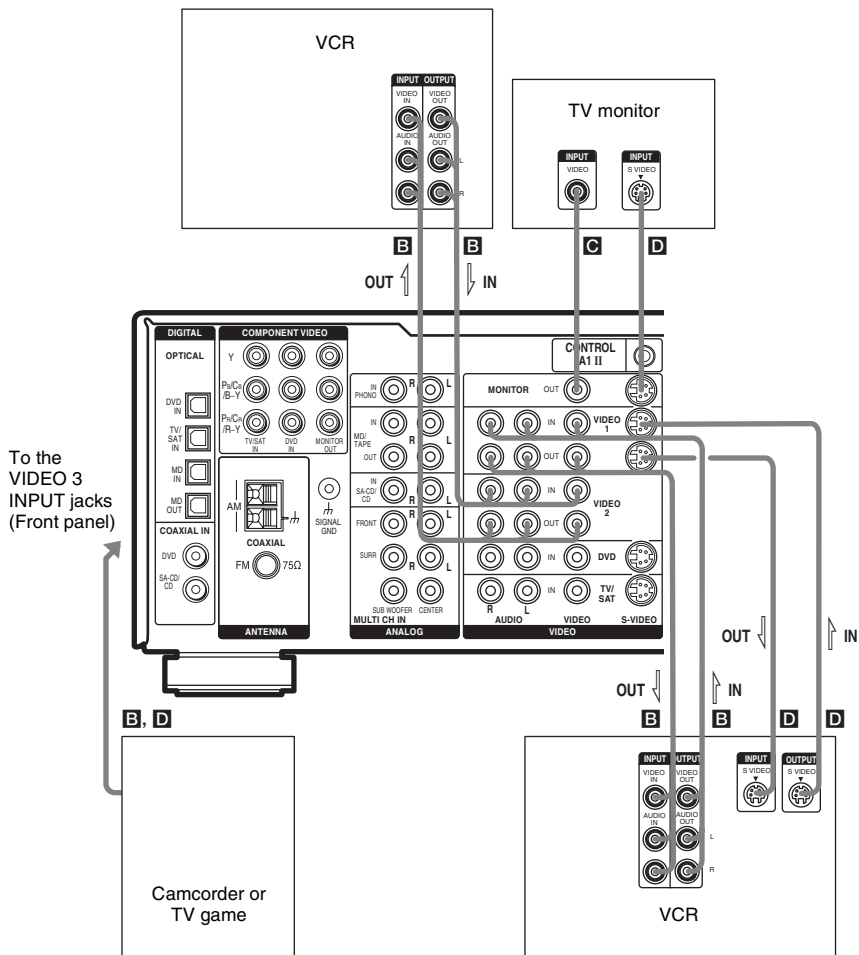

### Tip

This receiver can convert standard video signals to S-video signals for output from the MONITOR S-VIDEO OUT jacks.

## 2: Connecting the antennas

Connect the supplied AM loop antenna and FM wire antenna.

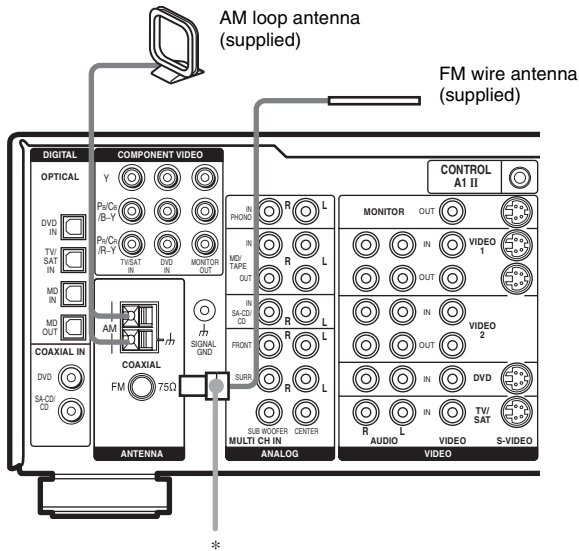

\* The shape of the connector varies depending on the area code.

### Notes

- To prevent noise pickup, keep the AM loop antenna away from the receiver and other components.
- Be sure to fully extend the FM wire antenna.
- After connecting the FM wire antenna, keep it as horizontal as possible.
- Do not use the  $\text{h}$  SIGNAL GND terminal for grounding the receiver.

## 3: Connecting speakers

Connect your speakers to the receiver. This receiver allows you to use a 7.1 channel system.

To fully enjoy theater-like multi channel surround sound requires five speakers (two front speakers, a center speaker, and two surround speakers) and a sub woofer (5.1 channel).

You can enjoy high fidelity reproduction of DVD software recorded in the Surround EX format if you connect one additional surround back speaker (6.1 channel) or two surround back speakers (7.1 channel) (see “Selecting the surround back decoding mode” on page 33).

### Example of 7.1 channel speaker system configuration

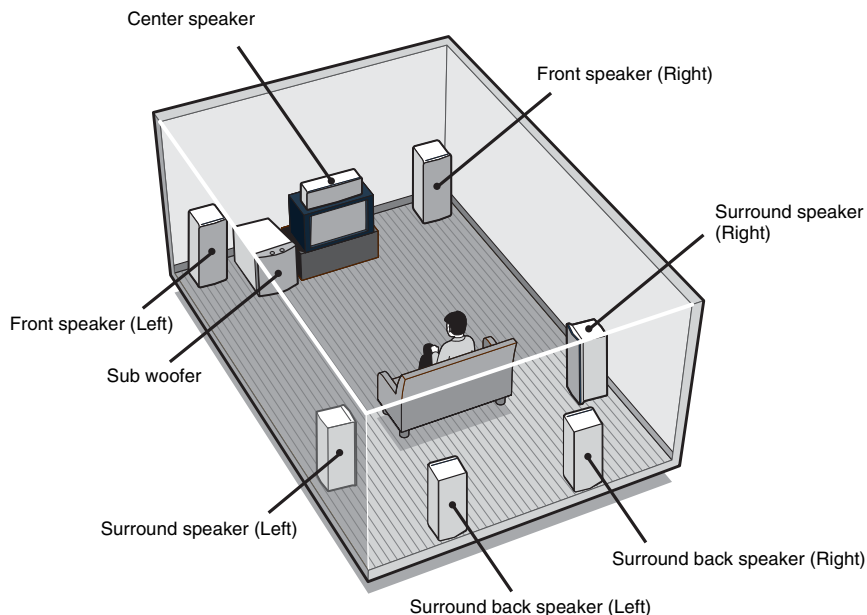

#### Tips

- When you connect 6.1 channel speaker system, place the surround back speaker right behind the listening position (see “When placing only one surround back speaker” illustration on page 18).
- Since the sub woofer does not emit highly directional signals, you can place it wherever you want.

#### Speaker impedance

To enjoy the best possible multi channel surround, connect speakers with a nominal impedance of 8 ohms or higher to the FRONT, CENTER, SURROUND and SURROUND BACK terminals, and set the IMPEDANCE SELECTOR to “8 $\Omega$ ”. Refer to the operating instructions supplied with your speakers if you are not sure of their impedance. (This information is often on the back of the speaker.) Alternatively, you may connect speakers with nominal impedances between 4 and 8 ohms to any or all of the speaker terminals. However, be sure to set the IMPEDANCE SELECTOR to “4 $\Omega$ ” if you connect even one speaker with a nominal impedance between 4 and 8 ohms.

#### Note

Be sure to turn the power off before adjusting the IMPEDANCE SELECTOR.

## Required cords

### A Speaker cords (not supplied)



### B Monaural audio cord (not supplied)

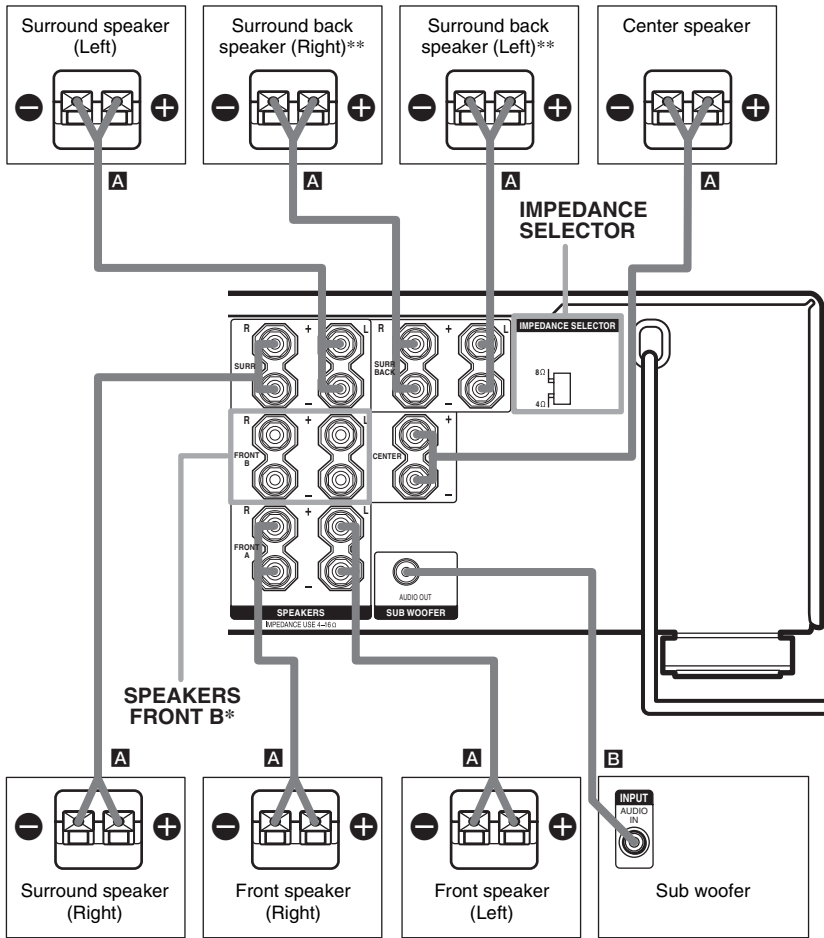

\* If you have an additional front speaker system, connect them to the SPEAKERS FRONT B terminals. You can select the front speakers you want to use with SPEAKERS (OFF/A/B/A+B) button. For details, see “Selecting the speaker system” (page 42).

\*\* If you connect only one surround back speaker, connect it to the SPEAKERS SURR BACK L terminal.

## 4: Connecting the AC power cord

Connect the AC power cord to a wall outlet.

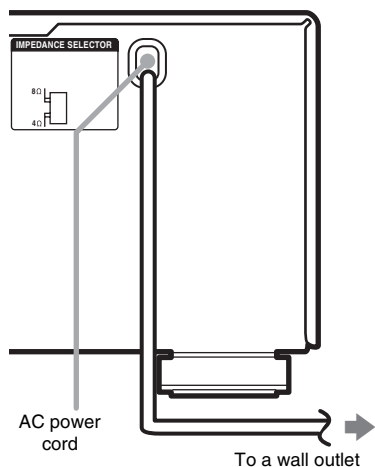

## Performing initial setup operations

Before using the receiver for the first time, initialize the receiver by performing the following procedure.

This procedure can also be used to return settings you have made to their factory defaults.

**1 Press I/⏻ to turn off the receiver.**

**2 Hold down I/⏻ for 5 seconds.**

“PUSH” and “ENTER” appears in the display alternately.

**3 Press MEMORY/ENTER.**

“CLEARING” appears in the display for a while, then “CLEARED” appears.

The following are reset to their factory settings.

- All settings in the SP SETUP, LEVEL, EQ, CUSTOMIZE and TUNER menus.
- The sound field memorized for each input and preset station.
- All preset stations.
- All index names for inputs and preset stations.



## 5: Setting up the speakers

You can use the SP SETUP menu to set the size and distance of the speakers connected to this system.

- 1 Press **I/⏻** to turn on the system.
- 2 Press **MAIN MENU** repeatedly to select “**SP SETUP**”.
- 3 Rotate **MENU** to select the menu item you want.

For more information, see “Speaker setup parameters”.

### Note

Some speaker setup items may appear dimmed in the display. This means that they have been adjusted automatically due to other speaker settings. Depending on the settings, you may or may not be able to adjust certain speakers.

- 4 Rotate **-/+** to select the parameter.
- 5 Repeat steps 3 and 4 until you have set all of the items that follow.

### Speaker setup parameters

The initial settings are underlined.

#### ■ **XXXX SET (Speaker easy setup)**

- EASY SET  
You can set up your speakers automatically by selecting a pre-defined speaker pattern (see the supplied “Easy Setup Guide”).
- NORM. SET  
Select to adjust the settings of each speaker manually.

#### ■ **SP PAT. XXX (Speaker setup pattern)**

When you select EASY SET, select the speaker setup pattern. Rotate **-/+** to select the speaker setup pattern and press **MEMORY/ENTER** to enter the selection. Check your speaker pattern using the supplied “Easy Setup Guide”.

#### ■ **(SUB WOOFER) (Sub woofer)**

- YES  
If you connect a sub woofer, select “YES”.
- NO  
If you did not connect a sub woofer, select “NO”. The front speakers are automatically set to “LARGE”. This activates the bass redirection circuitry and outputs the LFE signals from other speakers.

#### ■ **(FRONT) (Front speakers)**

- LARGE  
If you connect large speakers that will effectively reproduce bass frequencies, select “LARGE”. Normally, select “LARGE”.
- SMALL  
If the sound is distorted, or you feel a lack of surround effects when using multi channel surround sound, select “SMALL” to activate the bass redirection circuitry and output the front channel bass frequencies from the sub woofer. When the front speakers are set to “SMALL”, the center, surround and surround back speakers are also automatically set to “SMALL” (unless previously set to “NO”).

#### ■ **(CENTER) (Center speaker)**



- LARGE  
If you connect a large speaker that will effectively reproduce bass frequencies, select “LARGE”. Normally, select “LARGE”. However, if the front speakers are set to “SMALL”, you cannot set the center speaker to “LARGE”.
- SMALL  
If the sound is distorted, or you feel a lack of surround effects when using multi channel surround sound, select “SMALL” to activate the bass redirection circuitry and output the center channel bass frequencies from the front speakers (if set to “LARGE”) or sub woofer.
- NO (for all sources except MULTI CH IN)  
If you did not connect a center speaker, select “NO”. The sound of the center channel will be output from the front speakers (digital downmix).

- MIX (for all sources except MULTI CH IN)

If you did not connect a center speaker but want to downmix the center channel audio, select “MIX”.

This is only active when the front and surround speakers are set to “LARGE” (ANALOG DOWNMIX). In other cases, the center channel will be downmixed digitally (DIGITAL DOWNMIX).

- \* When using MULTI CH IN sources, the sound of the center channel is output from the front speakers if you select either “NO” or “MIX”.

■   (SURROUND)  
(Surround speakers)

- LARGE

If you connect large speakers that will effectively reproduce bass frequencies, select “LARGE”. Normally, select “LARGE”.

However, if the front speakers are set to “SMALL”, you cannot set the surround speakers to “LARGE”.

- SMALL

If the sound is distorted, or you feel a lack of surround effects when using multi channel surround sound, select “SMALL” to activate the bass redirection circuitry and output the surround channel bass frequencies from the sub woofer or other “LARGE” speakers.

- NO

If you did not connect surround speakers, select “NO”.

■   /  (SURR BACK)  
(Surround back speakers)

- DUAL

If you connect two surround back speakers, select “DUAL”. The sound will be output to a maximum of 7.1 channels.

- SINGLE

If you connect only one surround back speaker, select “SINGLE”. The sound will be output to a maximum of 6.1 channels.

- NO

If you did not connect surround back speakers, select “NO”.

**Tip**

The “LARGE” and “SMALL” settings for each speaker determine whether or not the internal sound processor will cut the bass signal from that channel. When the bass is cut from a channel, the bass redirection circuitry sends the corresponding bass frequencies to the sub woofer or other “LARGE” speakers.

However, it best not to cut them, if possible. Therefore, even when using small speakers, you can set them to “LARGE” if you want to output the bass frequencies from that speaker. On the other hand, if you are using a large speaker, but prefer not to have bass frequencies output from that speaker, set it to “SMALL”.

If the overall sound level is lower than you prefer, set all speakers to “LARGE”. If there is not enough bass, you can use the equalizer to boost the bass levels. To adjust the equalizer, see page 37.

■   DIST. X.X m (XX ft.)  
(Front speaker distance)

Initial setting: 3.0 m

Lets you set the distance from your listening position to the front speakers (A). You can adjust from 1.0 meter to 7.0 meters (3 to 23 feet) in 0.1 meter (1 foot) steps.

If both front speakers are not placed an equal distance from your listening position, set the distance to the closest speaker.

When placing only one surround back speaker

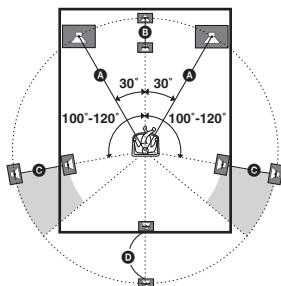

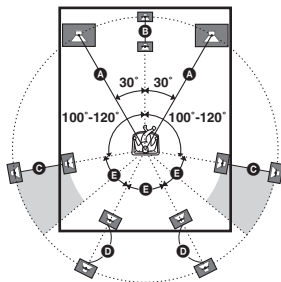

When placing two surround back speakers  
(The angle E should be the same)



■  **DIST. X.X m (XX ft.)**  
**(Center speaker distance)**

Initial setting: 3.0 m



Lets you set the distance from your listening position to the center speaker. You can adjust from 1.0 meter to 7.0 meters (3 to 23 feet) in 0.1 meter (1 foot) steps.

■   **DIST. X.X m (XX ft.)**  
**(Surround speaker distance)**

Initial setting: 3.0 m

Lets you set the distance from your listening position to the surround speakers. You can adjust from 1.0 meter to 7.0 meters (3 to 23 feet) in 0.1 meter (1 foot) steps.

If both surround speakers are not placed an equal distance from your listening position, set the distance to the closest speaker.

■    **DIST. X.X m (XX ft.)**  
**(Surround back speaker distance)**

Initial setting: 3.0 m

Lets you set the distance from your listening position to the surround back speaker. You can adjust from 1.0 meter to 7.0 meters (3 to 23 feet) in 0.1 meter (1 foot) steps.

If you connect two surround back speakers and both surround back speakers are not placed an equal distance from your listening position, set the distance to the closest speaker.

**Tip**

The receiver lets you to input the speaker position in terms of distance. However, it is not possible to set the center speaker further than the front speakers. Also, the center speaker cannot be set more than 1.5 meters (5 feet) closer than the front speakers.

Likewise, the surround speakers can not be set farther away from the listening position than the front speakers. And they can be no more than 4.5 meters (15 feet) closer.

This is because incorrect speaker placement is not conducive to the enjoyment of surround sound.

Please note that, setting the speaker distance closer than the actual location of the speakers will cause a delay in the output of the sound from that speaker. In other words, the speaker will sound like it is farther away.

For example, setting the center speaker distance 1–2 meters (3–6 feet) closer than the actual speaker position will create a fairly realistic sensation of being “inside” the screen. If you cannot obtain a satisfactory surround effect because the surround speakers are too close, setting the surround speaker distance closer (shorter) than the actual distance will create a larger sound stage.

Adjusting these parameter while listening to the sound often results in much better surround sound. Give it a try!

**For advanced speaker setups**

Use the CUSTOMIZE menu and set “MENU” to “MENU EXP.”. This enables advanced setups including those of the heights of the surround speakers.

For details on “MENU”, see page 37. For details on how to set the items, see page 38.

## 6: Adjusting the speaker levels and balance

### Note

The test tone cannot be used when ANALOG DIRECT or MULTI CH IN function is used.

### — TEST TONE

Adjust the speaker levels and balance while listening the test tone from your listening position. Use the remote for the operation.

#### Tip

The receiver employs a test tone with a frequency centered at 800 Hz.

**1** Press **1/⏻** on the remote to turn on the receiver.

**2** Press **TEST TONE** on the remote.

“T.TONE” appears in the display and the test tone is output from each speaker in sequence.

**3** Adjust the speaker level and balance using the **LEVEL** menu so that the level of the test tone sounds the same from each speaker.

For details on the LEVEL menu settings, see page 35.

#### Tips

- To adjust the level of all speakers at the same time, press **MASTER VOL +/-** on the remote or turn **MASTER VOLUME +/-** on the receiver.
- You can also use **-/+** on the receiver for the adjustment.

**4** Press **TEST TONE** again after adjustment.

The test tone turns off.

### To output the test tone only from a specific speaker

Set “T.TONE” in the LEVEL menu to “FIX” (page 35). The test tone is output only from the selected speaker.

### For more precise adjustment

You can output the test tone or sound source from two adjacent speakers to adjust their balance and level.

Set “MENU” in the CUSTOMIZE menu to “MENU EXP.” (page 37). Then select the two speakers you want to adjust using “P.NOISE” or “P.AUDIO” in the LEVEL menu (page 40).

### Selecting the component

#### 1 Rotate INPUT SELECTOR to select the input.

The selected input appears in the display.

To select the	Display
VCR	VIDEO 1 or VIDEO 2
Camcorder or TV game	VIDEO 3
DVD player	DVD
Satellite tuner	TV/SAT
MD or tape deck	MD/TAPE
CD or Super Audio CD player	SA-CD/CD
Built-in tuner (FM)	Tuner (FM)
Built-in tuner (AM)	Tuner (AM)
Turntable	PHONO

#### 2 Turn on the component and start playback.

#### 3 Rotate MASTER VOLUME $\rightarrow$ / $\leftarrow$ to adjust the volume.

#### To mute the sound

Press MUTING on the remote.

#### Notes on using headphones

- When headphones are connected, you can select only the following sound fields (page 32).
  - HEADPHONE (2CH)
  - HEADPHONE THEATER
- When headphones are connected and you use the MULTI CH IN function (see “Listening to multi channel sound”), the sound of all channels may not output depending on the speaker settings.

## Listening to multi channel sound

### — MULTI CH IN

You can select the audio directly from the components connected to the MULTI CH IN jacks. This enables you to enjoy high quality analog inputs like DVD or Super Audio CD. Also see “D.PWR” (page 38). Surround effects are not activated when using this input.

#### Press MULTI CH IN.

#### When a center speaker or sub woofer is not connected

If you have set the center speaker to “NO” or “MIX”, or set the sub woofer to “NO” in the SP SETUP menu (page 17), and you activate the MULTI CH IN function, the analog center or sub woofer audio will be output from the front left and right speakers.

#### When MULTI CHANNEL DECODING indicator lights up

The MULTI CHANNEL DECODING indicator lights up when the receiver is decoding multi channel sources.

However, this indicator does not light up if you select 2CH STEREO mode.

## Listening to FM/AM radio

You can listen to FM and AM broadcasts through the built-in tuner. Before operation, make sure you have connected the FM and AM antennas to the receiver (see page 13).

### Tip

The tuning scale differs depending on the area code as shown in the following table. For details on area codes, see page 2.

Area code	FM	AM
CEL, CEK, SP, AU, TW, KR	50 kHz	9 kHz

## Automatic tuning

- 1 Rotate INPUT SELECTOR to select FM or AM.**
- 2 Press TUNING + or TUNING –.**

Press TUNING + to scan from low to high; press TUNING – to scan from high to low. The receiver stops scanning whenever a station is received.

## In case of poor FM stereo reception

If the FM stereo reception is poor and “STEREO” flashes in the display, select monaural audio so that the sound will be less distorted.

- 1 Press MAIN MENU to select “TUNER”.**
- 2 Rotate MENU to select “FM AUTO”.**
- 3 Rotate –/+ to select “MONO”.**

The FM reception switches to monaural.

## Direct tuning

Enter a frequency of the station directly by using the numeric buttons on the remote.

For details on the supplied remote, refer to the operating instructions supplied with the remote.

- 1 Press TUNER on the remote repeatedly to select FM or AM.**

You can also use INPUT SELECTOR on the receiver.
- 2 Press ALT, then press D.TUNING on the remote.**
- 3 Press the numeric buttons on the remote to enter the frequency.**

Example 1: FM 102.50 MHz

Press 1 → 0 → 2 → 5 → 0

Example 2: AM 1,350 kHz

Press 1 → 3 → 5 → 0

If you've tuned in an AM station, adjust the direction of the AM loop antenna for optimum reception.

## If you cannot tune in a station and the entered numbers flash

Make sure you've entered the right frequency. If not, repeat step 3. If the entered numbers still flash, the frequency is not used in your area.

## Storing FM stations automatically

### — AUTOBETICAL

#### (Models of area code CEL, CEK only)

This function lets you store up to 30 FM and FM RDS stations in alphabetical order without redundancy. Additionally, it only stores the stations with the clearest signals.

If you want to store FM or AM stations one by one, see “Presetting radio stations”.

- 1 Press I/⏻ to turn off the receiver.
- 2 Hold down MEMORY/ENTER and press I/⏻ to turn the receiver back on.

“AUTO-BETICAL SELECT” appears in the display and the receiver scans and stores all the FM and FM RDS stations in the broadcast area.

For RDS stations, the tuner first checks for stations broadcasting the same program, then stores only the one with the clearest signal. The selected RDS stations are sorted alphabetically by their Program Service name, then assigned a 2-character preset code. For more details on RDS, see page 24.

Regular FM stations are assigned 2-character preset codes and stored after the RDS station.

When done, “FINISH” appears in the display momentarily and the receiver returns to the normal operation.

#### Notes

- Do not press any button on the receiver or supplied remote during autobetrical operation, except I/⏻.
- If you move to another area, repeat this procedure to store stations in your new area.
- For details on tuning the stored stations, see “Tuning to preset stations”.
- If you move the antenna after storing stations with this procedure, the stored settings may no longer be valid. If this happens, repeat this procedure to store the stations again.

## Presetting radio stations

You can preset up to 30 FM or AM stations. Then you can easily tune in the stations you often listen to.

### Presetting radio stations

- 1 Rotate INPUT SELECTOR to select FM or AM.
- 2 Tune in the station that you want to preset using Automatic Tuning (page 22) or Direct Tuning (page 22).
- 3 Press MEMORY/ENTER.  
“MEMORY” appears in the display for a few seconds. Do steps 4 to 5 before the display goes out.
- 4 Press PRESET TUNING + or PRESET TUNING – to select a preset number.  
If you want to switch the memory page, press SHIFT on the remote.  
If “MEMORY” goes out before you select the preset number, start again from step 3.
- 5 Press MEMORY/ENTER again.  
The station is stored to the selected preset number.  
If “MEMORY” goes out before you press MEMORY/ENTER, start again from step 3.
- 6 Repeat steps 2 to 5 to preset another station.

### Tuning to preset stations

- 1 Rotate INPUT SELECTOR to select FM or AM.
- 2 Press PRESET TUNING + or PRESET TUNING – repeatedly to select the preset station you want.  
Each time you press the button, you can select the preset station as follows:

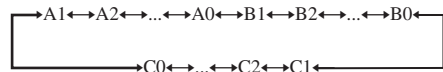

continued

## Using the remote

- 1 Press TUNER repeatedly to select FM or AM.
- 2 Press PRESET/CH/D.SKIP +/- repeatedly to select the preset station you want.

## To select the Preset station directly

### Press the numeric buttons on the remote.

The preset station of the selected number in the current memory page is tuned in. Press SHIFT on the remote to change the memory page.

## Using the Radio Data System (RDS)

### (Models of area code CEL, CEK only)

This receiver also allows you to use RDS (Radio Data System), which enables radio stations to send additional information along with the regular program signal. You can also display RDS information.

---

## Receiving RDS broadcasts

Simply select a station on the FM band using direct tuning (page 22), automatic tuning (page 22), or preset tuning (page 23).

When you tune in a station that provides RDS services, the RDS indicator lights up and the program service name appears in the display.

### Note

RDS may not work properly if the station you tuned to is not transmitting the RDS signal properly or if the signal strength is weak.

---

## Displaying RDS information

While receiving an RDS station, press **DISPLAY**.

Each time you press the button, RDS information on the display changes cyclically as follows:

PS (Program Service name) or preset station name<sup>a)</sup> → Frequency<sup>b)</sup> → PTY (Program Type) indication<sup>c)</sup> → RT (Radio Text) indication<sup>d)</sup> → CT (Current Time) indication (in 24-hour system) → Sound field currently applied → Volume level

<sup>a)</sup> This information appears only when PS is received or the preset station is indexed.

<sup>b)</sup> This information also appears for non-RDS FM stations.

<sup>c)</sup> Type of program being broadcast (see page 25).

<sup>d)</sup> Text messages sent by the RDS station.



**Notes**

- If there is an emergency announcement by government authorities, “ALARM” flashes in the display.
- If a station does not provide a particular RDS service, “NO XX” (such as “NO CT”) appears in the display.
- When a station broadcasts radio text data, it is displayed at the same rate at which it is sent from the station. Any change in this rate is reflected in the display rate of the data.

**Description of program types**

Program type indication	Description
NEWS	News programs
AFFAIRS	Topical programs that expand on current news
INFO	Programs offering information on a wide spectrum of subjects, including consumer affairs and medical advice
SPORT	Sports programs
EDUCATE	Educational programs, such as “how-to” and advice programs
DRAMA	Radio plays and serials
CULTURE	Programs about national or regional culture, such as language and social concerns
SCIENCE	Programs about the natural sciences and technology
VARIED	Other types of programs such as celebrity interviews, panel games, and comedy
POP M	Popular music programs
ROCK M	Rock music programs
EASY M	Easy Listening
LIGHT M	Instrumental, vocal, and choral music
CLASSICS	Performances of major orchestras, chamber music, opera, etc.
OTHER M	Music that does not fit into any categories above, such as Rhythm & Blues and Reggae
WEATHER	Weather information
FINANCE	Stock market reports and trading, etc.
CHILDREN	Programs for children
SOCIAL	Programs about people and the things that affect them

Program type indication	Description
RELIGION	Programs of religious content
PHONE IN	Programs where members of the public express their views by phone or in a public forum
TRAVEL	Programs about travel. Not for announcements that are located by TP/TA.
LEISURE	Programs on recreational activities such as gardening, fishing, cooking, etc.
JAZZ	Jazz programs
COUNTRY	Country music programs
NATION M	Programs featuring the popular music of the country or region
OLDIES	Programs featuring oldies music
FOLK M	Folk music programs
DOCUMENT	Investigative features
NONE	Any programs not defined above

## Changing the display

### Changing the information in the display

You can check the sound field etc. by changing the information in the display.

#### **Press DISPLAY repeatedly.**

Each time you press DISPLAY, the display will change as follows.

Index name\* → Input name → Sound field  
name → Volume level

\* Index name appears only when you have assigned one to the input or preset station (page 41). Index name does not appear when only blank spaces have been entered, or it is the same as the input name.

## About the indications in the display

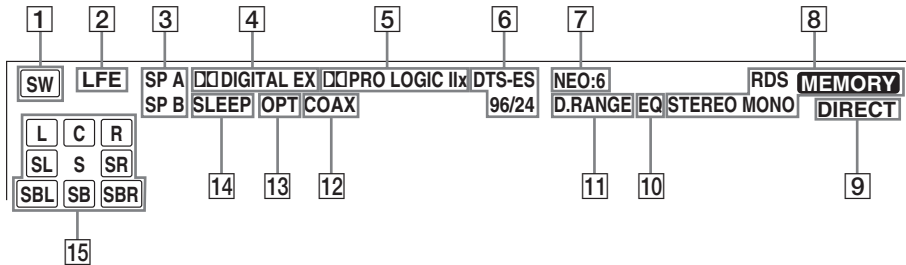

- 1 **SW:** Lights up when sub woofer selection is set to “YES” (page 17). While this indicator lights up, the receiver outputs the LFE signal recorded on the disc or generates a low frequency signal for output to the sub woofer. This indicator does not light during the 2CH STEREO mode.
- 2 **LFE:** Lights up when the disc being played back contains the LFE (Low Frequency Effect) channel and the LFE channel signal is actually being reproduced.
- 3 **SP A/SP B:** Lights up in accordance with the speaker system being used (A or B). Turns off when speaker output is turned off or when headphones are connected.
- 4 **DIGITAL EX:** Lights up when the receiver is decoding signals recorded in the Dolby Digital format.
- 5 **PRO LOGIC IIx:** “PRO LOGIC” lights up when the receiver applies Pro Logic processing to 2 channel signals in order to output the center and surround channel signals. “PRO LOGIC II” lights up when the Pro Logic II Movie/Music/Game decoder is activated. “PRO LOGIC IIx” lights up when the Pro Logic IIx Movie/Music/Game decoder is activated. However, these indicators do not light up if both the center and surround speakers are set to “NO” and you select a sound field using the A.F.D. button.

### Note

Dolby Pro Logic IIx decoding does not function for DTS format signals and for signals with a sampling frequency of more than 48 kHz.

- 6 **DTS-ES 96/24:** “DTS” lights up when DTS signals are input. “DTS-ES” lights up when DTS-ES signals are input. “DTS 96/24” lights up when the receiver is decoding DTS 96 kHz/24 bit signals.

### Note

When playing a DTS format disc, be sure that you have made digital connections and that INPUT MODE is not set to “ANALOG” (page 35).

- 7 **NEO:6:** Lights up when DTS Neo:6 cinema/music mode decoding is activated.
- 8 **Tuner indicators:** Lights up when using the receiver to tune in radio stations, etc. See pages 22–25 for tuner operations.
- 9 **DIRECT:** Lights up when the ANALOG DIRECT function is activated.
- 10 **EQ:** Lights up when the equalizer is activated.
- 11 **D.RANGE:** Lights up when dynamic range compression is activated (page 40).
- 12 **COAX:** Lights up when the source signal is a digital signal being input through the COAXIAL terminal.
- 13 **OPT:** Lights up when the source signal is a digital signal being input through the OPTICAL terminal.
- 14 **SLEEP:** Lights up when sleep timer is activated.

**15 Playback channel indicators:** The letters (L, C, R, etc.) indicate the channels being played back. The boxes around the letters vary to show how the receiver downmixes the source sound (based on the speakers settings).

L (Front Left), R (Front Right), C (Center (monaural)), SL (Surround Left), SR (Surround Right), S (Surround (monaural or the surround components obtained by Pro Logic processing)), SB (Surround Back (the surround back components obtained by 6.1 channel decoding)), SBL (Surround Back Left), SBR (Surround Back Right)

**Example:**

Recording format (Front /Surround): 3/2  
Output channel: Surround speakers absent  
Sound Field: A.F.D. AUTO

L	C	R
SL		SR

## Enjoying Surround Sound

### Using only the front speakers

In this mode, the receiver outputs the sound from the front L/R speakers only. There is no sound from the sub woofer.

### Listening to 2 channel stereo sources (2CH STEREO)

Standard 2 channel stereo sources completely bypass the sound field processing and multi channel surround formats are downmixed to 2 channel.

#### Press 2CH.

“2CH ST.” appears in the display and the receiver switches to the 2CH STEREO mode.

#### Note

No sound is output from the sub woofer in the 2CH STEREO mode. To listen to the 2 channel stereo sources using the front L/R speakers and a sub woofer, set to the A.F.D. mode.

### Listening to analog audio (ANALOG DIRECT)

You can switch the audio of the selected input to the two channel analog input. This function enables you to enjoy high quality analog sources. Also see “D.PWR” on page 38. When using this function, only the volume and front speaker balance can be adjusted.

**1** Rotate **INPUT SELECTOR** to select the input you want to listen to in analog audio.

**2** Press **DIRECT**.

“A.DIRECT” appears in the display and the analog audio is output.

#### Notes

- This function is cancelled when you switch the sound field (pages 29-32).
- When this function is used, test tone function cannot be used.

## Enjoying higher fidelity sound

### — AUTO FORMAT DIRECT

The Auto Format Direct (A.F.D.) mode allows you to select the decoding mode you want for your audio sound.

A.F.D. mode (Display)	Decoding mode
A.F.D. AUTO (A.F.D. AUTO)	As encoded
PRO LOGIC (DOLBY PL)	Dolby Pro Logic
PRO LOGIC II MOVIE (PLII MV)	Dolby Pro Logic II
PRO LOGIC II MUSIC (PLII MS)	
PRO LOGIC II GAME (PLII GM)	
PRO LOGIC IIx MOVIE (PLIIX MV)	Dolby Pro Logic IIx
PRO LOGIC IIx MUSIC (PLIIX MS)	
PRO LOGIC IIx GAME (PLIIX GM)	
Neo:6 Cinema (NEO6 CIN)	DTS Neo:6
Neo:6 Music (NEO6 MUS)	

---

## Decoding the input audio signal automatically

In this mode, the receiver automatically detects the type of audio signal being input (Dolby Digital, DTS, standard 2 channel stereo, etc.) and performs the proper decoding if necessary. This mode presents the sound as it was recorded/encoded, without adding any surround effects. However, if there are no low frequency signals (Dolby Digital LFE, etc.) it will generate a low frequency signal for output to the sub woofer.

**Press A.F.D. repeatedly to select “A.F.D. AUTO”.**

The receiver automatically detects the type of audio signal being input and performs the proper decoding if necessary.

### Tip

In most cases, “A.F.D. AUTO” provides the most appropriate decoding. You may want to use SURR BACK DECODING (page 33) to match the input stream to the mode you prefer.

---

## Enjoying stereo sound in multi channel (2 channel decoding mode)

This mode lets you specify the type of decoding for 2 channel audio sources. This receiver can reproduce 2 channel sound in 5 channels through Dolby Pro Logic II; 7 channels through Dolby Pro Logic IIx; 6 channels through DTS Neo:6; or 4 channels through Dolby Pro Logic. However, DTS 2CH sources are not decoded by DTS Neo:6; they are output in 2 channels.

**Press A.F.D. repeatedly to select the 2 channel decoding mode.**

### ■ DOLBY PL (PRO LOGIC)

Performs Dolby Pro Logic decoding. The source recorded in 2 channel is decoded into 4.1 channels.

### ■ PLII MV (PRO LOGIC II MOVIE)

Performs Dolby Pro Logic II Movie mode decoding. This setting is ideal for movies encoded in Dolby Surround. In Addition, this mode can reproduce sound in 5.1 channel when watching videos of overdubbed or old movies.

### ■ PLII MS (PRO LOGIC II MUSIC)

Performs the Dolby Pro Logic II Music mode decoding. This setting is ideal for normal stereo sources such as CDs.

### ■ PLII GM (PRO LOGIC II GAME)

Performs Dolby Pro Logic II Game mode decoding. This setting is ideal for video game softwares.

### ■ PLIIX MV (PRO LOGIC IIx MOVIE)

Performs Dolby Pro Logic IIx Movie mode decoding. This setting expands Dolby Pro Logic II Movie or Dolby Digital 5.1 to discrete 7.1 movie channels.

### ■ PLIIX MS (PRO LOGIC IIx MUSIC)

Performs Dolby Pro Logic IIx Music mode decoding. This setting shares hard “back” effects across all surround speakers.

### ■ PLIIX GM (PRO LOGIC IIx GAME)

Performs Dolby Pro Logic IIx Game mode decoding. This setting delivers full-impact special effect signals panned to the surround speakers.

### Note

Dolby Pro Logic IIx decoding does not function for DTS format signals and for signals with a sampling frequency of more than 48 kHz.

### ■ **NEO6 CIN (Neo:6 Cinema)**

Performs the DTS Neo:6 Cinema mode decoding.

### ■ **NEO6 MUS (Neo:6 Music)**

Performs the DTS Neo:6 Music mode decoding. This setting is ideal for normal stereo sources such as CDs.

### **If you connect a sub woofer**

When the audio signal is 2 channel stereo or if the source signal does not include a LFE signal, the receiver generates a low frequency signal for output to the sub woofer. However the low frequency signal is not generated when “Neo:6 Cinema” or “Neo:6 Music” is selected.

## Selecting a sound field

You can take advantage of surround sound simply by selecting one of the receiver’s pre-programmed sound fields. They bring the exciting and powerful sound of movie theaters and concert halls into your home.

### Selecting a sound field for movies

**Press MOVIE repeatedly to select the sound field you want.**

The selected sound field appears in the display.

Sound field	Display
CINEMA STUDIO EX A <b>DCS</b>	C.ST.EX A
CINEMA STUDIO EX B <b>DCS</b>	C.ST.EX B
CINEMA STUDIO EX C <b>DCS</b>	C.ST.EX C
VIRTUAL MULTI DIMENSION <b>DCS</b>	V. M. DIM

### About DCS (Digital Cinema Sound)

Sound fields with **DCS** marks use DCS technology.

DCS is the concept name of the surround technology for home theater developed by Sony. DCS uses the DSP (Digital Signal Processor) technology to reproduce the sound characteristics of an actual cinema cutting studio in Hollywood.

When played at home, DCS will create a powerful theater effect that mimics the artistic combination of sound and action as envisioned by the movie director.

#### ■ **C.ST.EX A (CINEMA STUDIO EX A) DCS**

Reproduces the sound characteristics of the Sony Pictures Entertainment “Cary Grant Theater” cinema production studio. This is a standard mode, great for watching most any type of movies.

#### ■ **C.ST.EX B (CINEMA STUDIO EX B) DCS**

Reproduces the sound characteristics of the Sony Pictures Entertainment “Kim Novak Theater” cinema production studio. This mode is ideal for watching science-fiction or action movies with lots of sound effects.

### ■ C.ST.EX C (CINEMA STUDIO EX C) DCS

Reproduces the sound characteristics of the Sony Pictures Entertainment scoring stage. This mode is ideal for watching musicals or films where orchestra music is featured in the soundtrack.

### ■ V. M. DIM (VIRTUAL MULTI DIMENSION) DCS

Creates 5 sets of virtual speakers from a single pair of actual surround speakers.

## About CINEMA STUDIO EX modes

CINEMA STUDIO EX modes are suitable for watching motion picture DVDs (etc.), with multi channel surround effects. You can reproduce the sound characteristics of Sony Pictures Entertainment's dubbing studio in your home.



The CINEMA STUDIO EX modes consist of the following three elements.

- Virtual Multi Dimension  
Creates 5 sets of virtual speakers from a single pair of actual surround speakers.
- Screen Depth Matching  
Creates the sensation that the sound is coming from inside the screen like in theaters.
- Cinema Studio Reverberation  
Reproduces the type of reverberation found in theaters.

The CINEMA STUDIO EX modes integrate these three elements simultaneously.

### Tip

You can identify the encoding format of DVD software, etc. by looking at the logo on the package.

-  : Dolby Digital discs
-  : Dolby Surround encoded programs
-  : DTS Digital Surround encoded programs

### Notes

- The effects provided by the virtual speakers may cause increased noise in the playback signal.
- When listening with sound fields that employ the virtual speakers, you will not be able to hear any sound coming directly from the surround speakers.

## Selecting a sound field for music

Press **MUSIC** repeatedly to select the sound field you want.

The selected sound field appears in the display.

Sound field	Display
HALL	HALL
JAZZ CLUB	JAZZ
LIVE CONCERT	CONCERT

### ■ HALL

Reproduces the acoustics of a classical concert hall.

### ■ JAZZ (JAZZ CLUB)

Reproduces the acoustics of a jazz club.

### ■ CONCERT (LIVE CONCERT)

Reproduces the acoustics of a 300-seat live house.

## When the headphones are connected

You can select only from the following sound fields.

### ■ HEADPHONE (2CH)

Outputs the sound in 2 channel (stereo). Standard 2 channel stereo sources completely bypass the sound field processing and multi channel surround formats are downmixed to 2 channels.

### ■ HEADPHONE THEATER DCS

Allows you to experience a theater-like environment while listening through a pair of headphones.

### Note

If you connect a pair of headphones while a sound field is operating, the system will automatically switch to HEADPHONE (2CH) if using a sound field selected with the 2CH or A.F.D. button, or to HEADPHONE THEATER if using a sound field selected with the MOVIE or MUSIC button.

## To turn off the surround effect

Press 2CH or A.F.D.

### Note

Sound fields does not function for PCM 96 kHz signals.



## Selecting the surround back decoding mode

### — *SURR BACK DECODING*

This function lets you select the decoding mode for the surround back signals of the multi channel input stream.

By decoding the surround back signal of DVD software (etc.) recorded in Dolby Digital EX, DTS-ES Matrix, DTS-ES Discrete 6.1, etc. format, you can enjoy the surround sound intended by the filmmakers.

**Press SURR BACK DECODING repeatedly to select the surround back decoding mode.**

For details, see “How to select the surround back decoding mode” on page 34.

#### **Tip**

You can select the surround back decoding mode using “SB XXXX” in the CUSTOMIZE menu (page 38).

#### **Note**

You can select the surround back decoding mode only when A.F.D. mode is selected.

---

## How to select the surround back decoding mode

You can select the surround back mode you want according to the input stream.

### When you select “OFF”

Surround back decoding is not performed.

### When you select “AUTO”

When the input stream contains the 6.1 channel decode flag<sup>a)</sup>, the appropriate decoder is applied to decode the surround back signal.

Input stream	Output channel	Applied surround back decoder
Dolby Digital 5.1	5.1	—
Dolby Digital EX <sup>b)</sup>	6.1	Matrix decoder conforms to Dolby Digital EX
DTS 5.1	5.1	—
DTS-ES Matrix 6.1 <sup>c)</sup>	6.1	DTS Matrix decoder
DTS-ES Discrete 6.1 <sup>d)</sup>	6.1	DTS Discrete decoder
Dolby Digital EX <sup>b)</sup>	7.1	Matrix decoder conforms to Dolby Pro Logic IIx
DTS-ES Matrix 6.1 <sup>c)</sup>	7.1	DTS Matrix decoder
DTS-ES Discrete 6.1 <sup>d)</sup>	7.1	DTS Discrete decoder

### When you select “ON”

To decode the surround back signal regardless of the 6.1 channel decode flag<sup>a)</sup>, Dolby Digital EX is applied when the output channel is 6.1 and Dolby Digital EX or Dolby Pro Logic IIx is applied when the output channel is 7.1.

Input stream	Output channel	Applied surround back decoder
Dolby Digital 5.1	6.1	Matrix decoder conforms to Dolby Digital EX
Dolby Digital EX <sup>b)</sup>	6.1	Matrix decoder conforms to Dolby Digital EX
DTS 5.1	6.1	Matrix decoder conforms to Dolby Digital EX
DTS-ES Matrix 6.1 <sup>c)</sup>	6.1	Matrix decoder conforms to Dolby Digital EX
DTS-ES Discrete 6.1 <sup>d)</sup>	6.1	Matrix decoder conforms to Dolby Digital EX
Dolby Digital 5.1	7.1	Matrix decoder conforms to Dolby Pro Logic IIx
Dolby Digital EX <sup>b)</sup>	7.1	Matrix decoder conforms to Dolby Pro Logic IIx
DTS 5.1	7.1	Matrix decoder conforms to Dolby Digital EX
DTS-ES Matrix 6.1 <sup>c)</sup>	7.1	Matrix decoder conforms to Dolby Digital EX
DTS-ES Discrete 6.1 <sup>d)</sup>	7.1	Matrix decoder conforms to Dolby Digital EX

<sup>a)</sup> 6.1 channel decode flag is the information recorded in software like DVDs.

<sup>b)</sup> Dolby Digital DVD that includes a Surround EX flag. The Dolby Corporation web page can help you distinguish Surround EX films.

<sup>c)</sup> Software encoded with a flag to denote it has both Surround EX and 5.1 channel signals.

<sup>d)</sup> Software encoded with both 5.1 channel signals and an extension stream designed for returning those signals to 6.1 discrete channels. Discrete 6.1 channel signals are DVD specific signals not used in movie theaters.

# Switching the audio input mode for digital components

### — INPUT MODE

You can switch the audio input mode for components which have digital audio input jacks.

- 1 Rotate INPUT SELECTOR to select the input.**
- 2 Press INPUT MODE repeatedly to select the audio input mode.**  
The selected audio input mode appears in the display.

### Audio input modes

- **AUTO IN**  
Gives priority to the analog audio signals input to the AUDIO IN (L/R) jacks when there is no digital audio signals.
- **COAX IN**  
Specifies the digital audio signals input to the DIGITAL COAXIAL input jack.
- **OPT IN**  
Specifies the digital audio signals input to the DIGITAL OPTICAL input jacks.
- **ANALOG**  
Specifies the analog audio signals input to the AUDIO IN (L/R) jacks.

## Customizing sound fields

By adjusting the LEVEL menu, you can customize the sound fields to suit your particular listening situation.

### Note on the displayed items

The setup items you can adjust in each menu vary depending on the sound field. Certain setup parameters may be dimmed in the display. This means that the selected parameter is either unavailable or fixed and unchangeable.

### Adjusting the LEVEL menu

You can adjust the balance and level of each speaker. These settings are applied to all sound fields.

- 1 Start playing a source encoded with multi channel surround effects (DVD, etc.).**
- 2 Press MAIN MENU repeatedly to select “LEVEL”.**
- 3 Rotate MENU to select the parameter.**  
For details, see “LEVEL menu parameters” below.
- 4 While monitoring the sound, rotate -/+ to adjust the selected parameter.**
- 5 Repeat steps 3 and 4 to adjust the other parameters.**

### LEVEL menu parameters

#### ■ T.TONE (Test Tone)

Initial setting: OFF

Lets you output the test tone sequentially from each speaker. When set to “AUTO”, the test tone is output from each speaker automatically. When set to “FIX”, you can select which speaker will output the test tone.

#### ■ BAL. XXXX (Front speaker balance)

Initial setting: 0 (BALANCE)

Lets you adjust the balance between front left and right speakers. You can adjust in the range of L (+1 to +16), BALANCE (0), R (+1 to +16) in 33 steps.

■ **CTR XXX.X dB**  
(Center speaker level)

■ **SUR.L. XXX.X dB**  
(Surround speaker (L) level)

■ **SUR.R. XXX.X dB**  
(Surround speaker (R) level)

■ **SB XXX.X dB**  
(Surround back speaker level)\*

■ **SBL XXX.X dB**  
(Surround back (L) level)\*\*

■ **SBR XXX.X dB**  
(Surround back (R) level)\*\*

■ **S.W. XXX.X dB**  
(Sub woofer level)

Initial setting: 0 dB

You can adjust from -20 dB to +10 dB in 0.5 dB steps.

■ **MULTI CH IN; S.W. XXX dB**  
(Multi channel sub woofer level)

Initial setting: 0 dB

Lets you increase the level of the MULTI CH IN sub woofer channel by +10 dB. This adjustment may be necessary when connecting a DVD player to the MULTI CH IN jacks. The sub woofer level from DVD players is 10 dB lower than Super Audio CD players.

\* Only when the surround back speaker is set to "SINGLE" in the SP SETUP menu.

\*\* Only when the surround back speaker is set to "DUAL" in the SP SETUP menu.

■ **EFCT. XXX (Effect level)**

Initial setting: STD

Lets you adjust the size of the surround effect.

#### Note

When one of the following sound fields is selected, no sound is output from the sub woofer if all the speakers are set to "LARGE" in the SP SETUP menu. However, the sound will be output from the sub woofer if the digital input signal contains LFE (Low Frequency Effect) signals, or if the front, center, or surround speakers are set to "SMALL".

- HALL

- JAZZ CLUB

- LIVE CONCERT

## For advanced LEVEL menu adjustments

Use the CUSTOMIZE menu and set "MENU" to "MENU EXP." to enable advanced adjustments.

For details on "MENU", see page 37. For details on how to set the items, see page 40.

---

## Resetting sound fields to the initial settings

**1** Press I/⏻ to turn off the power.

**2** While holding down 2CH, press I/⏻.

"SF. CLR." appears in the display and all sound fields are reset to the initial setting.

## Adjusting the equalizer

You can adjust the tonal quality (bass, treble level) of each speaker using the EQ menu.

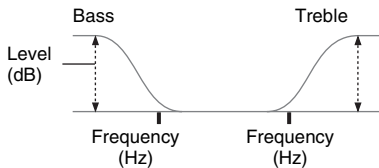

- 1 Start playing a source encoded with multi channel surround effects (DVD, etc.).
- 2 Press MAIN MENU repeatedly to select “EQ”.
- 3 Rotate MENU to select the parameter. For details, see “EQ menu parameters” below.
- 4 While monitoring the sound, rotate  $-/+$  to adjust the selected parameter.
- 5 Repeat steps 3 and 4 to adjust the other items.

### Note

You cannot adjust the equalizer when the system is decoding PCM 96 kHz signals, or when DTS 96/24, DTS-ES Matrix or DTS Neo:6 decoding is applied.

## EQ menu parameters

### ■ EQ

Initial setting: OFF

Select “ON” to activate the equalizer.

■ **BASS XXX.X dB**  
(Front speaker bass level)

■ **TREB. XXX.X dB**  
(Front speaker treble level)

Initial setting: 0 dB

You can adjust from  $-10$  dB to  $+10$  dB in 1 dB steps.

## Advanced settings

### Using the CUSTOMIZE menu to adjust the receiver

You can adjust various receiver settings using the CUSTOMIZE menu.

- 1 Press MAIN MENU repeatedly to select “CUSTOM”.
- 2 Rotate MENU to select the parameter. For details, see “CUSTOMIZE menu parameters” below.
- 3 Rotate  $-/+$  to adjust the selected parameter.
- 4 Repeat steps 2 and 3 to adjust the other items.

### CUSTOMIZE menu parameters

The initial setting is underlined>.

#### ■ MENU (Menu expanding)

- MENU EXP.

The advanced parameters for the SP SETUP and LEVEL menus are displayed and can be adjusted.

For details on each setup item, see pages 17, 35 and the following pages.

- MENU STD

The advanced parameters are not displayed.

#### ■ **96 XXXX** (DTS 96/24 decoding mode)

- 96 AUTO

When a DTS 96/24 signal is input, it is played back at 96 kHz sampling frequencies.

- 96 OFF

Even when a DTS 96/24 signal is input, it is played back at 48 kHz sampling frequencies.

### Notes

- This parameter is valid only in the A.F.D. mode (page 29). In other sound fields, this parameter is always set to “96 OFF”.
- DTS 96/24 decoding is only valid in the A.F.D. mode (page 29). When the system is set to other sound fields, standard 48 kHz decoding is used.
- Even when a DTS 96/24 signal is input, standard 48 kHz decoding is used if any speakers are set to “SMALL” or if the sub woofer is set to “NO”.

■ **SB XXXX**  
**(Surround back decoding mode)**

You can use the CUSTOMIZE menu to set the surround back decoding mode (page 33).

For details on each decoding mode, see page 34.

- OFF
- AUTO
- ON

**Note**

This parameter is valid only when A.F.D. mode is selected except for Dolby Pro Logic IIx mode (page 29).

■ **S.F XXXX (Sound field link)**

• S.F LINK

Lets you apply the last selected sound field to an input whenever it is selected. For example, if you select HALL for the SA-CD/CD input, then change to a different input and return to SA-CD/CD, HALL will automatically be applied again.

• S.F FIX

Sound field link is not activated.

■ **DEC. XXXX**  
**(Digital audio input decoding priority)**

Lets you specify the input mode for the digital signal input to the DIGITAL IN jacks.

The initial setting is “DEC. AUTO” for VIDEO 3 and TV/SAT, and “DEC. PCM” for DVD and MD/TAPE.

• DEC. AUTO

Automatically switches the input mode between DTS, Dolby Digital, or PCM.

• DEC. PCM

PCM signals are given priority (to prevent the interruption when playback starts). Even when other signals are input, the sound is output. However, this receiver cannot decode DTS-CD when set to “DEC. PCM”. When set to “DEC. AUTO” and the sound from the digital audio jacks (for CD, etc.) is interrupted when playback starts, set to “DEC. PCM”.

■ **D.PWR XXX**  
**(Digital power management)**

• D.PWR OFF

Lets you turn off the power of the unnecessary digital circuits automatically when outputting the analog audio signals using the ANALOG DIRECT or MULTI CH IN function. You can enjoy high quality analog audio without the influence of digital circuits.

• D.PWR ON

Lets you keep the power of digital circuits on. Select if you do not like the time lag that occurs with the “D.PWR OFF” setting.

■ **PWR.S. XXX**  
**(CONTROL A1II power save function)**

• ON

Lets you save the power consumption of the receiver during standby mode when the power save function is activated.

• OFF

Lets you turn on the system automatically when the component connected via monaural mini-plug cords (page 44) is turned on.

■ **DUAL XXX**  
**(Digital broadcast language selection)**

Lets you select the language you want to listen to during digital broadcast. This feature only functions for Dolby Digital sources.

• M/S (Main/Sub)

Sound of the main language will be output through the front left speaker and sound of the sub language will be output through the front right speaker simultaneously.

• M (Main)

Sound of the main language will be output.

• S (Sub)

Sound of the sub language will be output.

• M+S (Main + Sub)

Mixed sound of both the main and sub languages will be output.

■ **[DIMMER]**

Lets you adjust the brightness of the display.

■ **NAME IN**  
**(Naming preset stations and inputs)**

Lets you set the name of preset stations and inputs selected with INPUT SELECTOR. For details, see “Naming preset stations and inputs” on page 41.

---

## Advanced SP SETUP menu parameters

When “MENU” is set to “MENU EXP.”, all of the following parameters are displayed and adjustable.

See page 17 for the SP SETUP menu adjustments. Initial settings are underlined.

## All SP SETUP menu parameters

XXXX SET
SP PAT. XXX
(SUB WOOFER)
(FRONT)
(CENTER)
(SURROUND)
(SURR BACK)
DIST. X.X m (FRONT)
DIST. X.X m (CENTER)
DIST. X.X m (SURROUND)
DIST. X.X m (SURR BACK)
DISTANCE*
PL. XXXX*
HGT. XXXX*
SP > XXX Hz*

\* Adjustable only when "MENU" is set to "MENU EXP."

### ■ DISTANCE (Distance unit)

Lets you select the unit of measure for setting distances.

- ft.  
The distance is displayed in feet.
- m  
The distance is displayed in meters.

### ■ PL. XXXX (Surround speaker position)\*

Lets you specify the location of your surround speakers for proper implementation of the surround effects in the Cinema Studio EX modes (page 31).

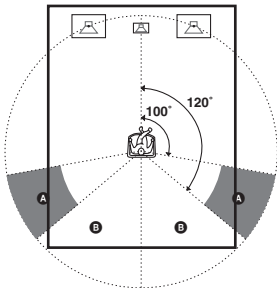

- SIDE  
Select if the location of your surround speakers corresponds to section **A**.
- BEHD  
Select if the location of your surround speakers corresponds to section **B**.

## Tip

Surround speaker position is designed specifically for implementation of the Cinema Studio EX modes.

For other sound fields, speaker position is not so critical. Those sound fields were designed under the premise that the surround speakers would be located behind the listening position, but presentation remains fairly consistent even with the surround speakers positioned at a rather wide angle. However, if the speakers are pointing toward the listener from the immediate left and right of the listening position, the surround effects becomes unclear unless set to "SIDE". Nevertheless, each listening environment has many variables, like wall reflections, and you may obtain better results using "BEHD" if your speakers are located high above the listening position, even if they are to the immediate left and right.

Therefore, although it may result in a setting contrary to the above explanation, we recommend that you playback multi channel surround encoded software and select the setting that provides a good sense of spaciousness and that best succeeds in forming a cohesive space between the surround sound from the surround speakers and the sound of the front speakers. If you are not sure which sounds best, select "BEHD" and then use the speaker distance parameter and speaker level adjustments to obtain proper balance.

### ■ HGT. XXXX (Surround speaker height)\*

Lets you specify the height of your surround speakers for proper implementation of the surround effects of the Cinema Studio EX modes (page 31).

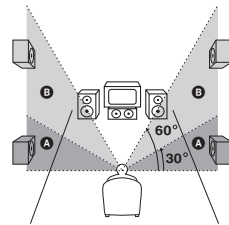

- LOW  
Select if the height of your surround speakers corresponds to section **A**.
- HIGH  
Select if the height of your surround speakers corresponds to section **B**.

\* This setup item is not available when the surround speaker parameter is set to "NO".

continued

### ■ SP > XXX Hz (Speaker crossover frequency)

Initial setting: 100 Hz

Lets you set the bass crossover frequency of speakers set to “SMALL” in the SP SETUP menu. You can adjust the bass crossover frequency in three steps (60 Hz, 100 Hz and 150 Hz).

---

## Advanced LEVEL menu parameters

When “MENU” is set to “MENU EXP.”, all of the following parameters are displayed and adjustable.

See page 35 for the LEVEL menu adjustments. Initial settings are underlined.

### All LEVEL menu parameters

---

T.TONE

---

P.NOISE\*

---

P.AUDIO\*

---

BAL. XXXX

---

CTR XXX.X dB

---

SUR.L. XXX.X dB

---

SUR.R. XXX.X dB

---

SB XXX.X dB

---

SBL XXX.X dB\*\*

---

SBR XXX.X dB\*\*

---

S.W. XXX.X dB

---

\*\*\*\*\*  
MULTI CH IN: S.W. XXX dB  
\*\*\*\*\*

---

\*\*\*\*\*  
D.RANGE: COMP. XXX\*  
\*\*\*\*\*

---

EFCT. XXX

---

\* Adjustable only when “MENU” is set to “MENU EXP.”

\*\* Adjustable only when surround back speaker is set to “DUAL” (page 18).

### ■ P.NOISE (Phase noise)

Initial setting: OFF

Lets you output the test tone sequentially from two adjacent speakers.

### ■ P.AUDIO (Phase audio)

Initial setting: OFF

Lets you output the front 2 channel source sound (instead of the test tone) sequentially from adjacent speakers.

### ■ \*\*\*\*\* D.RANGE: COMP. XXX \*\*\*\*\* (Dynamic range compressor)

Lets you compress the dynamic range of the sound track. This may be useful when you want to watch movies at low volumes late at night.

- OFF

The dynamic range is not compressed.

- STD

The dynamic range is compressed as intended by the recording engineer.

- MAX

The dynamic range is compressed dramatically.

### Tip

Dynamic range compressor lets you compress the dynamic range of the soundtrack based on the dynamic range information included in the Dolby Digital signal. We recommend using the “MAX” setting. This greatly compresses the dynamic range and lets you view movies late at night at low volumes. Unlike analog limiters, the levels are predetermined and provide a very natural compression.

### Note

Dynamic range compression is possible with Dolby Digital sources only.



## Naming preset stations and inputs

You can enter a name of up to 8 characters for preset stations and inputs selected with INPUT SELECTOR, and display it in the receiver's display.

### To index a preset station

- 1 Rotate INPUT SELECTOR to select FM or AM.**
- 2 Tune in the preset station you want to create an index name for (page 23).**
- 3 Press MAIN MENU repeatedly to select "TUNER".**
- 4 Rotate MENU to select "NAME IN".**
- 5 Press MEMORY/ENTER.**

The cursor flashes and you can select a character. Follow the procedure of "To create an index name".

### To index an input

- 1 Rotate INPUT SELECTOR to select an input you want to create an index name for.**
- 2 Press MAIN MENU repeatedly to select "CUSTOM".**
- 3 Rotate MENU to select "NAME IN".**
- 4 Press MEMORY/ENTER.**

The cursor flashes and you can select a character. Follow the procedure of "To create an index name".

### To create an index name

- 1 Use MENU and -/+ to create an index name.**

Rotate -/+ to select a character, then rotate MENU to move the cursor to the next position.

#### Tips

- You can select the character type as follows by rotating -/+. Alphabet (upper case) → Numbers → Symbols
- To enter a blank space, rotate -/+ until a blank space appears in the display.
- If you made a mistake, rotate MENU until the character you want to change flashes, then rotate -/+ to select the correct character.

- 2 Press MEMORY/ENTER.**

The entered name is registered.

#### Note (Models of area code CEL, CEK only)

When you name an RDS station and tune in the station, the Program Service (PS) name appears instead of the name you entered. (You cannot change the name of a Program Service (PS) name. The name you entered will be overwritten by the Program Service (PS) name.)

## Using the Sleep Timer

You can set the receiver to turn off automatically at a specified time. Use the remote for the operation.

**1 Press ALT to light up the button.**

**2 Press SLEEP while the power is on.**

Each time you press SLEEP, the display changes cyclically as follows:

2:00:00 → 1:30:00 → 1:00:00 →

0:30:00 → OFF

While using Sleep Timer, "SLEEP" lights up in the display.

### Tip

To check the remaining time before the receiver turns off, press ALT to light up the button (page 46), then press SLEEP. The remaining time appears in the display. If you press SLEEP again, the sleep timer will be canceled.

## Selecting the speaker system

You can select the front speaker system you want to use.

**Press SPEAKERS (OFF/A/B/A+B) repeatedly to select the front speaker system you want to use.**

The selected speaker system appears in the display. To turn off the speaker output, press SPEAKERS (OFF/A/B/A+B) repeatedly until SP A and SP B indication turn off.

### The speaker system

- SP A  
The speakers connected to the FRONT SPEAKERS A terminals.
- SP B  
The speakers connected to the FRONT SPEAKERS B terminals.
- SP A and SP B  
The speakers connected to both the FRONT SPEAKERS A and B terminals (parallel connection). In this case, be sure to connect front speakers with a nominal impedance of 8 ohms or higher, and set the IMPEDANCE SELECTOR to "4Ω".

## Recording

Before you begin, make sure you've connected all components properly.

### Recording on an audio tape or MiniDisc

You can record on a MiniDisc or cassette tape using the receiver. See the operating instructions of your cassette deck or MD deck if you need help.

- 1 Select the component to be recorded.**
- 2 Prepare the component for playing.**  
For example, insert a CD into the CD player.
- 3 Insert a blank tape or MD into the recording deck and adjust the recording level, if necessary.**
- 4 Start recording on the recording deck, then start playback on the playback component.**

#### Notes

- You cannot record a digital audio signal using a component connected to the analog MD/TAPE OUT jacks. To record a digital audio signal, connect a digital component to the DIGITAL OPTICAL MD OUT jacks.
- Sound adjustments do not affect the signal output from the MD/TAPE OUT jacks.
- The analog audio signals of the current input is output from the MD/TAPE OUT jacks.
- The signals input to the MULTI CH IN jacks are not output from the MD/TAPE OUT jacks even when MULTI CH IN is being used. The analog audio signals of the current or previously used input are output.
- No signals are output from DIGITAL OPTICAL MD OUT jacks when ANALOG DIRECT is being used. The digital circuitry power is cut off to ensure superior sound quality when "D.PWR" is set to "D.PWR OFF".

### Recording on a video tape

You can record from a VCR or a TV using the receiver. You can also add audio from a variety of audio sources when editing a video tape. See the operating instructions of your VCR if you need help.

- 1 Select the program source to be recorded.**
- 2 Prepare the component for playing.**  
For example, insert a video tape you want to record into VCR.
- 3 Insert a blank video tape into the VCR (VIDEO 1 or VIDEO 2) for recording.**
- 4 Start recording on the recording VCR, then start playing the video tape or laser disc you want to record.**

#### Notes

- You cannot record a digital audio signal using a component connected to the analog VIDEO 1 OUT or VIDEO 2 OUT jacks.
- Make sure to make both digital and analog connections to the TV/SAT and DVD inputs. Analog recording is not possible if you make only digital connections.
- Some sources contain copy guards to prevent recording. In this case, you may not be able to record from the sources.
- The analog audio signals of the current input are output from the VIDEO 1 OUT or VIDEO 2 OUT jacks.
- The signals input to the MULTI CH IN jacks are not output from VIDEO 1 OUT or VIDEO 2 OUT jacks even when MULTI CH IN is being used. The analog audio signals of the current or previously used input are output.

## CONTROL A1II Control System

The CONTROL A1II Control System was designed to simplify the operation of audio systems composed of separate Sony components. CONTROL A1II connections provide a path for the transmission of control signals which enable automatic operation and control features usually associated with integrated systems. Currently, CONTROL A1II connections between a Sony CD player, amplifier (receiver), MD deck and cassette deck provide automatic function selection.

### Note

Do not operate a 2 way remote control unit when the CONTROL A1II jacks are connected via a PC interface kit to a personal computer running "MD Editor" or similar application. Also, do not operate the connected component in a manner contrary to the functions of the application, as this may cause the application to operate incorrectly.

### CONTROL A1II and CONTROL A1 compatibility

The CONTROL A1 control system has been updated to the CONTROL A1II which is the standard system in the Sony 300 disc CD changer and other recent Sony components. Components with CONTROL A1 jacks are compatible with components with CONTROL A1II, and can be connected to each other. Basically, the majority of the functions available with the CONTROL A1 control system will be available with the CONTROL A1II control system.

However, when making connections between components with CONTROL A1 jacks and components with CONTROL A1II jacks, the number of functions that can be controlled may be limited depending on the component. For detailed information, refer to the operating instructions supplied with the component(s).

### If you have a Sony CD changer with a COMMAND MODE selector

If your CD changer's COMMAND MODE selector can be set to CD 1, CD 2, or CD 3, be sure to set the command mode to "CD 1" and connect the changer to the CD jacks on the amplifier (receiver).

If, however, you have a Sony CD changer with VIDEO OUT jacks, set the command mode to "CD 2" and connect the changer to the VIDEO 2 jacks on the amplifier (receiver).

## Connections

You can connect up to 10 CONTROL A1II compatible components in any order. However, you can connect only one of each type of component (i.e., 1 CD player, 1 MD deck, 1 tape deck and 1 receiver).

(You may be able to connect more than one CD player or MD deck, depending on the model. Refer to the operating instructions supplied with the respective component for details.)

Example

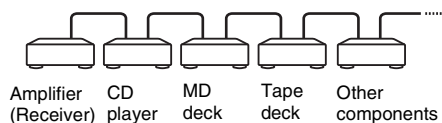

In the CONTROL A1II control system, the control signals flow both ways, so there is no distinction of IN and OUT jacks. If a component has more than one CONTROL A1II jack, you can use either one, or connect different components to each jack.

Some CONTROL A1 compatible components are supplied with a connecting cord as an accessory. In this case, use the connecting cord for your connection.

When using a commercially available cord, use a monaural (2P) mini-plug cord less than 2 meters long, with no resistance.

## Basic Functions

The input selector on the receiver automatically switches to the correct input when you press the play button on one of the connected components (Auto input selection).

The CONTROL A1II functions will operate as long as the component you want to operate is turned on, even if all of the other connected components are not turned on.

### Note

When recording, do not play any components other than the recording source. It will cause the automatic input selection to operate.

## Operations Using the Remote RM-PP413

You can use the remote RM-PP413 to operate the components in your system.

### Before you use your remote

#### Inserting batteries into the remote

Insert R6 (size-AA) batteries with the + and – properly oriented in the battery compartment. When using the remote, point it at the remote sensor  on the receiver.

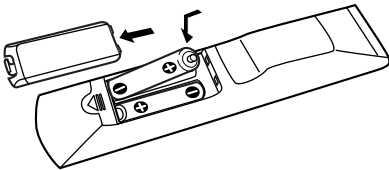

#### Tip

Under normal conditions, the batteries should last for about 6 months. When the remote no longer operates the receiver, replace all batteries with new ones.

#### Notes

- Do not leave the remote in an extremely hot or humid place.
- Do not use a new battery with an old one.
- Do not expose the remote sensor to direct sunlight or lighting apparatuses. Doing so may cause a malfunction.
- If you don't use the remote for an extended period of time, remove the batteries to avoid possible damage from battery leakage and corrosion.

### Remote button description

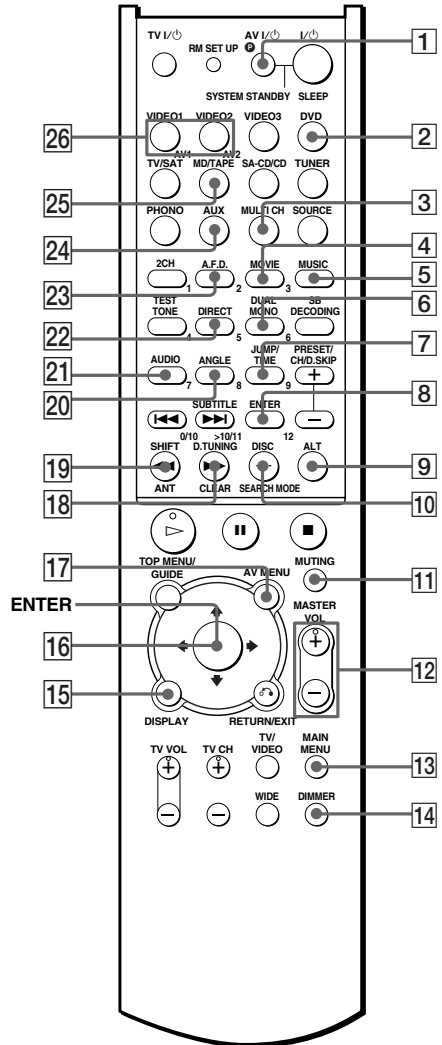

The tables below show the settings of each button.

Remote Button	Operations	Function
A.F.D. <b>23</b>	Receiver	Selects the decoding mode for audio sound.
ALT <b>9</b>	Remote	When ALT button lights up, it changes the remote key function to activate those buttons with orange printing.
ANGLE <b>20</b>	DVD player	Selects viewing angle or changes the angles.
ANT <b>19</b>	VCR	Selects output signal from the antenna terminal: TV signal or VCR program.
AUDIO <b>21</b>	TV/VCR/ DVD player	Changes the sound to Multiplex, Bilingual or Multi channel TV Sound.
AUX <b>24</b>	Receiver	To listen to an audio equipment.
AV MENU <b>17</b>	VCR/ Satellite tuner/ DVD player	Displays menu.
AV1 and AV2 <b>26</b>	Remote	Selects the command mode of the remote.
AV I/⏻ <b>1</b>	TV/VCR/ CD player/ VCD player/ LD player/ DVD player/ MD deck/ DAT deck	Turns the audio and video components on or off.
CLEAR <b>18</b>	CD player/ DVD player	Clears a mistake when you press the incorrect numeric buttons or returns to continuous playback etc.
DIMMER <b>14</b>	Receiver	Adjusts the brightness of the display.
DIRECT <b>22</b>	Receiver	Selects 2CH ANALOG DIRECT.
DISC <b>10</b>	CD player/ VCD player	Selects a disc directly (multi-disc changer only).

Remote Button	Operations	Function
DISPLAY <b>15</b>	TV/VCR/ VCD player/ LD player/ DVD player	Selects information displayed on the TV screen.
D.TUNING <b>18</b>	Receiver	Enters direct tuning mode.
DUAL MONO <b>6</b>	Receiver	Selects the language you want during digital broadcast.
DVD <b>2</b>	Receiver	To watch DVD.
ENTER <b>8</b>	TV/VCR/ satellite tuner/ LD player/ MD deck/ DAT deck/ Tape deck	After selecting a channel, disc or track using the numeric buttons, press to enter the value.
ENTER <b>16</b>	Receiver/ VCR/ Satellite tuner/ DVD player	Enters the selection.
JUMP/TIME <b>7</b>	Satellite tuner	Toggles between the previous and the current channels.
	CD player/ MD deck/ VCD player/ DVD player	Shows the time or displays the playing time of disc, etc.
MAIN MENU <b>13</b>	Receiver	Selects the menu of the receiver.
MASTER VOL +/- <b>12</b>	Receiver	Adjusts the master volume of the receiver.
MD/TAPE <b>25</b>	Receiver	To listen to Minidisc or audio tape.
MOVIE <b>4</b>	Receiver	Selects the pre-programmed sound fields for movie.
MULTI CH <b>3</b>	Receiver	Selects MULTI CH IN source.
MUSIC <b>5</b>	Receiver	Selects the pre-programmed sound fields for music.
MUTING <b>11</b>	Receiver	Mutes the sound from the receiver.

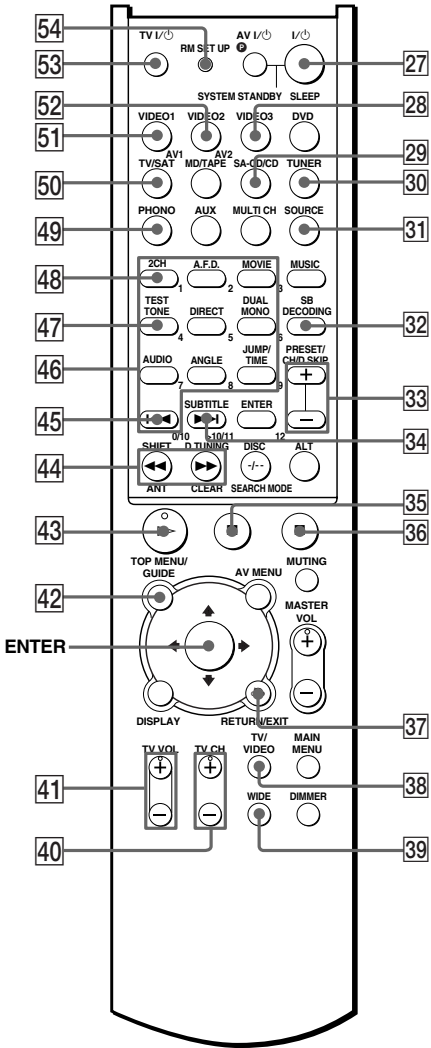

Remote Button	Operations	Function
PHONO <a href="#">49</a>	Receiver	To listen to turntable.
PRESET/CH/	Receiver	Selects preset stations.
D.SKIP +/- <a href="#">33</a>	TV/VCR/ satellite tuner	Selects preset channels.
	CD player/ VCD player/ DVD player/ MD deck	Skips discs (multi-disc changer only).
RETURN/ EXIT <a href="#">37</a>	VCD player/ LD player/ DVD player	Returns to the previous menu.
	Satellite tuner	Exits the menu.
RM SET UP <a href="#">54</a>	Remote	To set up the remote.
SA-CD/CD <a href="#">29</a>	Receiver	To listen to Super Audio CD or compact disc.
SB DECODING <a href="#">32</a>	Receiver	Selects the surround back decoding modes.
SEARCH MODE <a href="#">10</a>	DVD player	Selects searching mode. Press to select the unit for search (track, index, etc.)
SHIFT <a href="#">19</a>	Receiver	Selects a memory page for presetting radio stations or tuning to preset stations.
SLEEP <a href="#">27</a>	Receiver	Activates the sleep function and the duration which the receiver turns off automatically.
SOURCE <a href="#">31</a>	Remote	Selects 2ND AV output.
SUBTITLE <a href="#">34</a>	DVD player	Changes the subtitles.
SYSTEM STANDBY (Press AV I/O <a href="#">1</a> and I/O <a href="#">27</a> at the same time)	Receiver/ TV/VCR/ Satellite tuner/ CD player/ VCD player/ LD player/ DVD player/ MD deck/ DAT deck	Turns off the receiver and other Sony audio/video components.
TEST TONE <a href="#">47</a>	Receiver	Outputs test tone.

continued

Remote Button	Operations	Function
TOP MENU/	DVD player	Displays DVD title.
GUIDE <b>42</b>	Satellite tuner	Displays guide menu.
TUNER <b>30</b>	Receiver	To listen to radio programs.
TV CH +/- <b>40</b>	TV	Selects preset TV channels.
TV/SAT <b>50</b>	Receiver	To watch TV programs or satellite receiver.
TV/VIDEO <b>38</b>	TV	Selects input signal: TV input or video input.
TV VOL +/- <b>41</b>	TV	Adjusts the volume of the TV.
TV I/⏻ <b>53</b>	TV	Turns the TV on or off.
VIDEO1 <b>51</b>	Receiver	To watch VCR. (VTR mode 3)
VIDEO2 <b>52</b>	Receiver	To watch VCR. (VTR mode 1)
VIDEO3 <b>28</b>	Receiver	To watch VCR. (VTR mode 2)
WIDE <b>39</b>	TV	Selects the wide picture mode.
1-9 and 0/10 <b>46</b>	Receiver	Use with SHIFT to preset radio station or tuning to preset stations and with D.TUNING for direct tuning.
	CD player/ VCD player/ LD player/ MD deck/ DAT deck	Selects track numbers. 0/10 selects track 10.
	TV/VCR/ Satellite tuner	Selects channel numbers.
2CH <b>48</b>	Receiver	Selects 2CH STEREO mode.
>10/11 <b>34</b>	CD player/ VCD player/ LD player/ MD deck	Selects track numbers over 10.
-/-- <b>10</b>	TV	Selects the channel entry mode, either one or two digit.

Remote Button	Operations	Function
I/⏻ <b>27</b>	Receiver	Turns the receiver on or off.
◀◀/▶▶ <b>45</b> <b>34</b>	VCR/ CD player/ VCD player/ LD player/ DVD player/ MD deck/ DAT deck/ Tape deck	Skips tracks.
◀◀/▶▶ <b>44</b>	CD player/ VCD player/ DVD player/ LD player/ MD deck	Searches tracks in the forward or backward direction.
	VCR/ DAT deck/ Tape deck	Fastforwards or rewinds.
▶ <b>43</b>	VCR/ CD player/ VCD player/ LD player/ DVD player/ MD deck/ DAT deck/ Tape deck	Starts playback.
⏸ <b>35</b>	VCR/ CD player/ VCD player/ LD player/ DVD player/ MD deck/ DAT deck/ Tape deck	Pauses playback or recording. (Also starts recording with components in recording standby.)
■ <b>36</b>	VCR/ CD player/ VCD player/ LD player/ DVD player/ MD deck/ DAT deck/ Tape deck	Stops playback.
↶ <b>37</b>	VCD player/ LD player/ DVD player	Returns to the previous menu or exits the menu.
⬆/⬇ <b>16</b>	Receiver	Selects a menu item.
⬅/➡ <b>16</b>	Receiver	Adjusts or changes the setting.
⬆/⬇/⬅/➡ <b>16</b>	VCR/ Satellite tuner/ DVD player	Selects a menu item.



**Notes**

- Some functions explained in this section may not work depending on the model.
- The above explanation is intended to serve as an example only. Therefore, depending on the component the above operation may not be possible or may operate differently than described.
- To activate the buttons with orange printing, press ALT first before pressing the buttons.
- The SOURCE button on the remote is not available for receiver operation.

## Selecting the command mode of the remote

Set the remote command mode using the RM SET UP button and the remote command mode buttons.

**Selecting the command mode**

You can switch the command mode (AV1 and AV2) of the remote. If the command mode of the receiver and the remote is different, you cannot use the remote to operate the receiver.

**Press AV1 (or AV2) while holding down RM SET UP.**

The indicator flashes once (twice for AV2) , then the command mode switches.

**To check the command mode of the remote**

Press RM SET UP. You can check the remote by the indicator.

Mode	Indicator flashes
AV1	once
AV2	twice

**To reset the remote to factory settings**

Press I/⏻, AV I/⏻ and MASTER VOL – at the same time.

The indicator flashes 3 times, then goes off.

**Note**

If the command mode of the receiver and the remote is different, you cannot use the remote to operate the receiver. To change the command mode of the receiver, see page 55.

## Programming the remote

You can program the remote to control non-Sony components by changing the code. Once the control signals have been memorized, you can use those components as part of your system.

Furthermore, you can also program the remote for Sony components that the remote is unable to control. Note that the remote can only control components that accept infrared wireless control signals.

### **1 Press AV I/⏻ while holding down RM SET UP.**

The indicator lights up.

### **2 Press the input button (including TV I/⏻) for the component you want to control.**

For example, if you are going to control a CD player, press SA-CD/CD.

### **3 Press the numeric buttons to enter the numeric code (or one of the codes if more than one code exists) corresponding to the component and the maker of the component you want to control.**

See the tables on pages 51–52 for information on the numeric code(s) corresponding to the component and the maker of the component (the first digit and the last two digits of the numeric code correspond to the category and the maker's code respectively).

### **4 Press ENTER.**

Once the numeric code has been verified, the indicator slowly flashes twice and the remote automatically exits the programming mode.

### **5 Repeat steps 1 to 4 to control other components.**

## **To cancel programming**

Press RM SET UP during any step. The remote automatically exits the programming mode.

## **To activate the input after programming**

Press the programmed button to activate the input you want.

## **If programming is unsuccessful, check the following:**

- If the indicator does not light up in step 1, the batteries are weak. Replace both batteries.
- If the indicator flashes 4 times in quick succession while entering the numeric code, an error has occurred. Start again from step 1.

## **Notes**

- The indicator turns off while a valid button is pressed.
- In step 2, if several input buttons are pressed, only the last pressed button is valid.
- In step 2, if you press TV I/⏻, only TV VOL +/-, TV CH +/-, TV/VIDEO and WIDE buttons are reprogrammed.
- In step 3, if an input button is pressed, the new input is selected and the programming procedure returns to the beginning of step 3.
- For the numeric codes, only the first three numbers entered are valid.

## **To clear the memory of the remote**

To clear all programmed, do the following to reset the remote to factory settings.

### **Press I/⏻, AV I/⏻ and MASTER VOL – at the same time.**

The indicator flashes 3 times, then goes off.

## The numeric codes corresponding to the component and the maker of the component

Use the numeric codes in the tables below to control non-Sony components and also Sony components that the remote is normally unable to control. Since the remote signal that a component accepts differs depending on the model and year of the component, more than one numeric code may be assigned to a component. If you fail to program your remote using one of the codes, try using other codes.

### Notes

- The numeric codes are based on the latest information available for each brand. There is a chance, however, that your component will not respond to some or all of the codes.
- All of the input buttons on this remote may not be available when used with your particular component.

### To control a CD player

Maker	Code(s)
SONY	101, 102, 103
DENON	104, 123
JVC	105, 106, 107
KENWOOD	108, 109, 110
MAGNAVOX	111, 116
MARANTZ	116
ONKYO	112, 113, 114
PANASONIC	115
PHILIPS	116
PIONEER	117
TECHNICS	115, 118, 119
YAMAHA	120, 121, 122

### To control a DAT deck

Maker	Code(s)
SONY	203
PIONEER	219

### To control an MD deck

Maker	Code(s)
SONY	301
DENON	302
JVC	303
KENWOOD	304

### To control a tape deck

Maker	Code(s)
SONY	201, 202
DENON	204, 205
KENWOOD	206, 207, 208, 209
NAKAMICHI	210
PANASONIC	216
PHILIPS	211, 212
PIONEER	213, 214
TECHNICS	215, 216
YAMAHA	217, 218

### To control an LD player

Maker	Code(s)
SONY	601, 602, 603
PIONEER	606

### To control a video CD player

Maker	Code(s)
SONY	605

## To control a VCR

Maker	Code(s)
SONY	701, 702, 703, 704, 705, 706
AIWA*	710, 750, 757, 758
AKAI	707, 708, 709, 759
BLAUPUNKT	740
EMERSON	711, 712, 713, 714, 715, 716, 750
FISHER	717, 718, 719, 720
GENERAL ELECTRIC	721, 722, 730
GOLDSTAR	723, 753
GRUNDIG	724
HITACHI	722, 725, 729, 741
ITT/NOKIA	717
JVC	726, 727, 728, 736
MAGNAVOX	730, 731, 738
MITSUBISHI/MGA	732, 733, 734, 735
NEC	736
PANASONIC	729, 730, 737, 738, 739, 740
PHILIPS	729, 730, 731
PIONEER	729
RCA/PROSCAN	722, 729, 730, 731, 741, 747
SAMSUNG	742, 743, 744, 745
SANYO	717, 720, 746
SHARP	748, 749
TELEFUNKEN	751, 752
TOSHIBA	747, 755, 756
ZENITH	754

\* If an AIWA VCR does not work even though you enter the code for AIWA, enter the code for Sony instead.

## To control a DVD player

Maker	Code(s)
SONY	401, 402, 403
PANASONIC	406, 408
PHILIPS	407
PIONEER	409
TOSHIBA	404
DENON	405

## To control a TV

Maker	Code(s)
SONY	501, 502
DAEWOO	504, 505, 506, 507, 515, 544
FISHER	508
GOLDSTAR	503, 511, 512, 515, 534, 544
GRUNDIG	517, 534
HITACHI	513, 514, 515, 544
ITT/NOKIA	521, 522
JVC	516
MAGNAVOX	503, 518, 544
MITSUBISHI/MGA	503, 519, 544
NEC	503, 520, 544
PANASONIC	509, 524
PHILIPS	515, 518
PIONEER	509, 525, 526, 540
RCA/PROSCAN	510, 527, 528, 529, 544
SAMSUNG	503, 515, 531, 532, 533, 534, 544
SANYO	508, 545, 546, 547
SHARP	535
TELEFUNKEN	523, 536, 537, 538
THOMSON	530, 537, 539
TOSHIBA	535, 540, 541
ZENITH	542, 543

## To control a satellite tuner or cable box

Maker	Code(s)
SONY	801, 802, 803, 804
JERROLD/G.I.	806, 807, 808, 809, 810, 811, 812, 813, 814
PANASONIC	818
RCA	805, 819
S. ATLANTA	815, 816, 817

## To control a tuner

Maker	Code(s)
SONY	002, 003, 004, 005

### Precautions

#### On safety

Should any solid object or liquid fall into the cabinet, unplug the receiver and have it checked by qualified personnel before operating it any further.

#### On power sources

- Before operating the unit, check that the operating voltage is identical with your local power supply. The operating voltage is indicated on the nameplate at the rear of the receiver.
- The unit is not disconnected from the AC power source (mains) as long as it is connected to the wall outlet, even if the unit itself has been turned off.
- If you are not going to use the receiver for a long time, be sure to disconnect the receiver from the wall outlet. To disconnect the AC power cord, grasp the plug itself; never pull the cord.
- AC power cord must be changed only at the qualified service shop.

#### On heat buildup

Although the unit heats up during operation, this is not a malfunction. If you continuously use this unit at a large volume, the cabinet temperature of the top, side and bottom rises considerably. To avoid burning yourself, do not touch the cabinet.

#### On placement

- Place the receiver in a location with adequate ventilation to prevent heat buildup and prolong the life of the receiver.
- Do not place the receiver near heat sources, or in a place subject to direct sunlight, excessive dust or mechanical shock.
- Do not place anything on top of the cabinet that might block the ventilation holes and cause malfunctions.

#### On operation

Before connecting other components, be sure to turn off and unplug the receiver.

#### On cleaning

Clean the cabinet, panel and controls with a soft cloth slightly moistened with a mild detergent solution. Do not use any type of abrasive pad, scouring powder or solvent such as alcohol or benzine.

If you have any question or problem concerning your receiver, please consult your nearest Sony dealer.

## Troubleshooting

If you experience any of the following difficulties while using the receiver, use this troubleshooting guide to help you remedy the problem. Should any problem persist, consult your nearest Sony dealer.

---

### There is no sound no matter which component is selected.

- Check that both the receiver and all components are turned on.
- Check that the MASTER VOLUME  $-/+$  control is not set at  $-\infty$  dB.
- Check that the SPEAKERS (OFF/A/B/A+B) is not set to off (page 42).
- Check that all speaker cords are connected correctly.
- Press MUTING on the remote to cancel the muting function.

---

### There is no sound from a specific component.

- Check that the component is connected correctly to the audio input jacks for that component.
- Check that the cord(s) used for the connection is (are) fully inserted into the jacks on both the receiver and the component.

---

### There is no sound from one of the front speakers.

- Connect a pair of headphones to the PHONES jack to verify that sound is output from the headphones. If only one channel is output from the headphones, the component may not be connected to the receiver correctly. Check that all the cords are fully inserted into the jacks on both the receiver and the component. If both channels are output from the headphones, the front speaker may not be connected to the receiver correctly. Check the connection of the front speaker which is not outputting any sound.

---

**There is no sound or only a very low-level sound is heard.**

- Check that the speakers and components are connected securely.
- Check that you have selected the correct component on the receiver.
- Check that the SPEAKERS (OFF/A/B/A+B) is not set to off (page 42).
- Check that the headphones are not connected.
- Press MUTING on the remote to cancel the muting function.
- The protective device on the receiver has been activated because of a short circuit. Turn off the receiver, eliminate the short-circuit problem and turn on the power again.

---

**There is no sound from analog 2 channel sources.**

- Check that the INPUT MODE is not set to “COAX IN” nor “OPT IN” (page 35).
- Check that the MULTI CH IN function is selected.

---

**There is no sound from digital sources (from COAXIAL or OPTICAL input jack).**

- Check that the INPUT MODE is not set to “ANALOG” (page 35). Check that the INPUT MODE is not set to “COAX IN” for the sources from OPTICAL input jack, nor set to “OPT IN” for the sources from COAXIAL input jack.
- Check that the MULTI CH IN function is selected.

---

**The left and right sounds are unbalanced or reversed.**

- Check that the speakers and components are connected correctly and securely.
- Adjust balance parameters in the LEVEL menu.

---

**There is severe hum or noise.**

- Check that the speakers and components are connected securely.
- Check that the connecting cords are away from a transformer or motor, and at least 3 meters away from a TV set or fluorescent light.
- Move your TV away from the audio components.
- Make sure you have grounded  $\perp$  SIGNAL GND terminal (only when a turntable is connected).
- The plugs and jacks are dirty. Wipe them with a cloth slightly moistened with alcohol.

---

**There is no sound from the center speaker.**

- Make sure the sound field function is on (press A.F.D., MOVIE or MUSIC).
- Select the CINEMA STUDIO EX mode (page 31).
- Adjust the speaker level (page 20).
- Make sure the center speaker is set to either “SMALL” or “LARGE” (page 17).

---

**There is no sound from the surround back speakers.**

- Some discs have no Dolby Digital EX flag even though the packages have Dolby Digital EX logos. In this case, select “ON” (page 38).

---

**There is no sound or only a very low-level sound is heard from the surround/surround back speakers.**

- Make sure the sound field function is on (press A.F.D., MOVIE or MUSIC).
- Select a CINEMA STUDIO EX mode (page 31).
- Adjust the speaker level (page 20).
- Make sure the surround speakers are set to either “SMALL” or “LARGE” (page 18).
- Make sure the surround back speaker is set to either “DUAL” or “SINGLE” (page 18).

---

**The surround effect cannot be obtained.**

- Make sure the sound field function is on (press A.F.D., MOVIE or MUSIC).
- Sound fields do not function for the signals with a sampling frequency of more than 48 kHz.

---

**Dolby Digital or DTS multi channel sound is not reproduced.**

- Check that the playing DVD, etc. is recorded in Dolby Digital or DTS format.
- When connecting the DVD player, etc. to the digital input jacks of this receiver, check the audio setting (settings for the audio output) of the connected component.

---

**Recording cannot be done.**

- Check that the components are connected correctly.
- Select the source component with INPUT SELECTOR.

---

### The FM reception is poor.

- Use a 75-ohm coaxial cable (not supplied) to connect the receiver to an outdoor FM antenna as shown below. If you connect the receiver to an outdoor antenna, ground it against lightning. To prevent a gas explosion, do not connect the ground wire to a gas pipe.

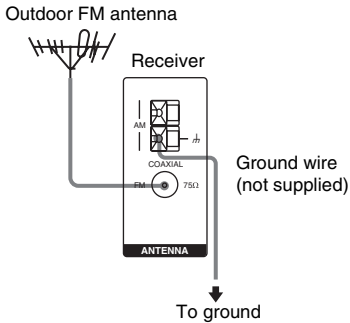

---

### Radio stations cannot be tuned in.

- Check that the antennas are connected securely. Adjust the antennas and connect an external antenna if necessary.
- The signal strength of the stations is too weak (when tuning in with automatic tuning). Use direct tuning.
- Make sure you set the tuning interval correctly (when tuning in AM stations with direct tuning).
- No stations have been preset or the preset stations have been cleared (when tuning by scanning preset stations). Preset the stations (page 23).
- Press DISPLAY so that the frequency appears in the display.

---

### RDS does not work.\*

- Make sure that you're tuned to an FM RDS station.
- Select a stronger FM station.

---

### The RDS information that you want does not appear.\*

- Contact the radio station and find out whether or not they actually provide the service in question. If so, the service may be temporarily out of order.

---

### There is no picture or an unclear picture appears on the TV screen or monitor.

- Select the appropriate input on the receiver.
- Set your TV to the appropriate input mode.
- Move your TV away from the audio components.

---

### The DIGITAL OPTICAL MD OUT jack flashes red.

- When "AUTO IN" is selected for INPUT MODE, the jack flashes red when no digital audio signal is input. This is dependent on the INPUT MODE function, and is not a malfunction.

---

## Remote control

---

### The remote does not function.

- Point the remote at the remote sensor  on the receiver.
- Remove any obstacles in the path between the remote and the receiver.
- Replace all the batteries in the remote with new ones, if they are weak.
- Check if the command modes of the receiver and the remote is the same. If the command mode of the receiver and the remote is different, you cannot operate the receiver with the remote. To switch the command mode of the receiver, press I/⏻ to turn off the power. Then, press I/⏻ while pressing INPUT MODE. Each time you press I/⏻, the command mode switches between "C.MODE. AV2" and "C.MODE. AV1". (The initial setting is "C.MODE. AV2".)
- Make sure you select the correct input on the remote.

---

\* Models of area code CEL, CEK only.

---

## Error messages

If there is a malfunction, the display shows a code of two numbers and a message. You can check the condition of the system by the message. Refer to the following table to solve the problem. If any problem persists, consult your nearest Sony dealer.

---

### DEC. EROR

Appears when the signal which the receiver cannot decode (ex. DTS-CD) is input when "DEC. XXXX" is set to "DEC. PCM". Set to "DEC. AUTO".

---

### PROTECT

Irregular current is output from the speakers. Turn off the receiver, check the speaker connection and turn on the power again. If this problem persists, turn off the receiver and consult your nearest Sony dealer.

## Reference sections for clearing the memory

To clear	See
All memorized settings	page 16
Customized sound fields	page 36

## Specifications

### Amplifier section

#### POWER OUTPUT

Models of area code CEL, CEK, AU, TW, KR

Rated Power Output at Stereo Mode

(8 ohms 1 kHz, THD 0.7%)

100 W + 100 W<sup>2)</sup>

90 W + 90 W<sup>3)</sup>

Reference Power Output<sup>2)</sup>

(8 ohms 20 Hz–20 kHz, THD 0.09%)

FRONT<sup>1)</sup>: 90 W + 90 W

CENTER<sup>1)</sup>: 90 W

SURR<sup>1)</sup>: 90 W + 90 W

SURR BACK<sup>1)</sup>: 90 W + 90 W

(8 ohms 1 kHz, THD 0.7%)

FRONT<sup>1)</sup>: 100 W + 100 W

CENTER<sup>1)</sup>: 100 W

SURR<sup>1)</sup>: 100 W + 100 W

SURR BACK<sup>1)</sup>: 100 W + 100 W

(8 ohms 1 kHz, THD 10%)

FRONT<sup>1)</sup>: 110 W + 110 W

CENTER<sup>1)</sup>: 110 W

SURR<sup>1)</sup>: 110 W + 110 W

SURR BACK<sup>1)</sup>: 110 W + 110 W

Models of area code SP

Rated Power Output at Stereo Mode

(8 ohms 1 kHz, THD 0.7%)

90 W + 90 W<sup>2)</sup>

Reference Power Output<sup>2)</sup>

(8 ohms 1 kHz, THD 0.7%)

FRONT<sup>1)</sup>: 90 W + 90 W

CENTER<sup>1)</sup>: 90 W

SURR<sup>1)</sup>: 90 W + 90 W

SURR BACK<sup>1)</sup>: 90 W + 90 W

1) Depending on the sound field settings and the source, there may be no sound output.

2) Measured under the following conditions:

Area code	Power requirements
SP, CEL, CEK, KR	230 V AC, 50 Hz
AU	240 V AC, 50 Hz
TW	110 V AC, 60 Hz

3) Measured under the following conditions:

Area code	Power requirements
KR	220 V AC, 50 Hz



## Frequency response

PHONO	RIAA equalization curve $\pm 0.5$ dB
MULTI CH IN, SA-CD/ CD, MD/TAPE, DVD, TV/SAT, VIDEO 1, 2, 3	10 Hz – 100 kHz +0.5/-2 dB (when ANALOG DIRECT is selected)

## Inputs (Analog)

PHONO	Sensitivity: 2.5 mV Impedance: 50 kilohms S/N <sup>3)</sup> : 86 dB (A, 2.5 mV <sup>4)</sup> )
MULTI CH IN, SA-CD/ CD, MD/TAPE, DVD, TV/SAT, VIDEO 1, 2, 3	Sensitivity: 150 mV Impedance: 50 kilohms S/N <sup>4)</sup> : 96 dB (A, 150 mV <sup>5)</sup> )

4) INPUT SHORT.

5) Weighted network, input level.

## Inputs (Digital)

DVD (Coaxial)	Impedance: 75 ohms S/N: 100 dB (A, 20 kHz LPF)
DVD, TV/SAT, MD, VIDEO3 (Optical)	S/N: 100 dB (A, 20 kHz LPF)

## Outputs

MD/TAPE (REC OUT), VIDEO 1, 2 (AUDIO OUT)	Voltage: 150 mV Impedance: 2.2 kilohms
SUB WOOFER	Voltage: 2 V Impedance: 1 kilohms

## EQ

Gain levels	$\pm 10$ dB, 1 dB step
-------------	------------------------

## FM tuner section

Tuning range	87.5 - 108.0 MHz
Antenna	FM wire antenna
Antenna terminals	75 ohms, unbalanced
Intermediate frequency	10.7 MHz
Sensitivity	
Mono:	18.3 dBf, 2.2 $\mu$ V/75 ohms
Stereo:	38.3 dBf, 22.5 $\mu$ V/75 ohms
Useable sensitivity	11.2 dBf, 1 $\mu$ V/75 ohms
S/N	
Mono:	76 dB
Stereo:	70 dB
Harmonic distortion at 1 kHz	
Mono:	0.3%
Stereo:	0.5%
Separation	45 dB at 1 kHz
Frequency response	30 Hz – 15 kHz, +0.5/-2 dB
Selectivity	60 dB at 400 kHz

## AM tuner section

Tuning range	
Models of area code CEL, CEK, SP, AU, TW, KR With 9-kHz tuning scale	531 – 1,602 kHz
Antenna	Loop antenna
Intermediate frequency	450 kHz
Usable sensitivity	50 dB/m (at 1,000 kHz or 999 kHz)
S/N	54 dB (at 50 mV/m)
Harmonic distortion	0.5% (50 mV/m, 400 Hz)
Selectivity	
At 9 kHz:	35 dB

## Video section

Inputs/Outputs	
Video:	1 Vp-p, 75 ohms
S-video:	Y: 1 Vp-p, 75 ohms C: 0.286 Vp-p, 75 ohms
COMPONENT VIDEO:	Y: 1 Vp-p, 75 ohms B-Y: 0.7 Vp-p, 75 ohms R-Y: 0.7 Vp-p, 75 ohms 80 MHz HD Pass Through

## General

### Power requirements

Area code	Power requirements
CEL, CEK	230 V AC, 50/60 Hz
AU	240 V AC, 50 Hz
SP	220-230 V AC, 50/60 Hz
TW	110 V AC, 60 Hz
KR	220-230 V AC, 50/60 Hz

## Power consumption

Area code	Power consumption
CEL, CEK, AU, SP, KR	270 W
TW	650 W

Power consumption (during standby mode)

0.3 W (when “POWER  
SAVE” in the  
CUSTOMIZE menu is set  
to “ON”) (page 38)

Dimensions

430 × 161 × 400 mm  
including projecting parts  
and controls

Mass (Approx.)

14.5 kg

## Supplied accessories

FM wire antenna (1)

AM loop antenna (1)

Remote commander RM-PP413 (1)

R6 (size-AA) batteries (2)

For details on the area code of the component you  
are using, see page 2.

Design and specifications are subject to change  
without notice.

# List of button locations and reference pages

## How to use this page

Use this page to find the location of buttons and other parts of the system that are mentioned in the text.

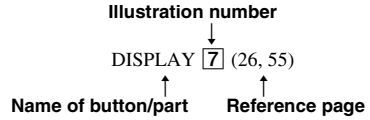

## Main unit

### ALPHABETICAL ORDER

- A.F.D. **15** (30, 32, 54)
- DIRECT **10** (29)
- DISPLAY **7** (26, 55)
- Display **5** (27)
- INPUT MODE **8** (35)
- INPUT SELECTOR **12** (21, 22, 23, 29, 35, 38, 41)
- IR receptor **1** (45, 55)
- MAIN MENU **3** (17, 35, 37, 41)
- MASTER VOLUME -/+ **9** (20, 21)
- MEMORY/ENTER **4** (16, 17, 23, 41)

- MENU **22** (17, 19, 35, 37, 41)
- MOVIE **14** (31, 32, 54)
- MULTICHANNEL DECODING indicator **6** (21)
- MULTI CH IN **11** (21)
- MUSIC **13** (32, 54)
- PHONES jack **23** (53)
- PRESET TUNING -/+ **19** (23)
- SPEAKERS (OFF/A/B/A+B) **24** (15, 42, 54)
- SURR BACK DECODING **17** (33)
- TUNING -/+ **18** (22)
- VIDEO 3 INPUT jacks **21** (12)

### NUMBERS AND SYMBOLS

- 2CH **16** (29, 32)
- /+ **20** (17, 35, 37, 41)
- I/⏻ (power) **2** (16, 17, 36)

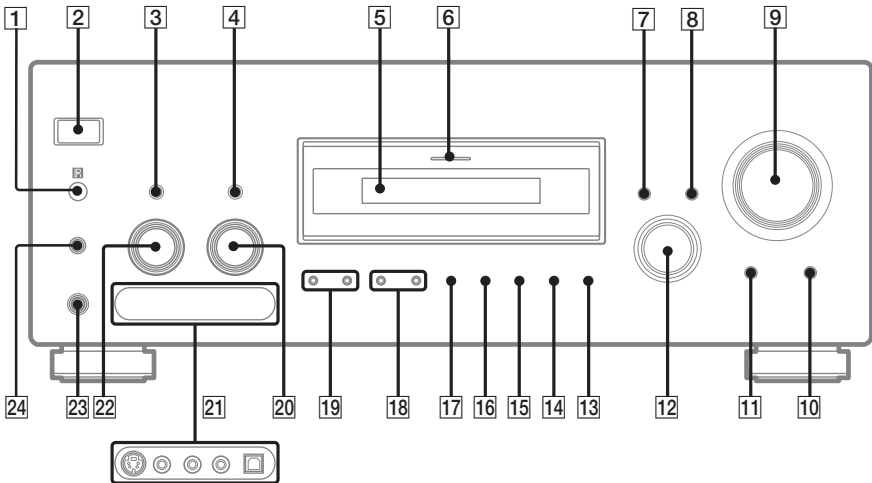

## To remove the cover



Press PUSH to remove the cover. When you remove the cover, keep the cover out of reach of the children.

# Index

## A

Adjusting

- CUSTOMIZE parameters 37
- EQ parameter 37
- LEVEL parameter 35, 40
- SP SETUP parameters 17, 38
- speaker volume 20

Automatic tuning 22

## C

Changing

- display 26

Clearing receiver's memory 16

Crossover frequency 40

CUSTOMIZE menu 37

## D

Digital Cinema Sound 31

Direct tuning 22

Dual Mono 38

Dubbing. *See* Recording

## E

Editing. *See* Recording

EQ menu 37

## I

Indexing. *See* Naming

## L

Labeling. *See* Naming

LEVEL menu 35, 40

## N

Naming 41

## P

Preset stations

- how to 23
- how to tune 23

## R

RDS 24

Recording

- on a video tape 43
- on an audio tape or MD 43

## S

Selecting

- component 21
- front speaker system 42
- sound field 31–32

Sleep Timer 42

Sound field

- customizing 35
- pre-programmed 31–32
- resetting 36
- selecting 31–32

SP SETUP menu 17, 38

Speakers

- adjusting speaker volume 20
- connection 14
- impedance 14
- placement 14

Supplied accessories 58

## T

Test tone 20

Tuning

- automatically 22
- directly 22
- preset stations 23